

UNCLASSIFIED

AD NUMBER
ADA134347
NEW LIMITATION CHANGE
TO Approved for public release, distribution unlimited
FROM Distribution authorized to U.S. Gov't. agencies and their contractors; Administrative/Operational Use; 23 JAN 2009. Other requests shall be referred to CDR US Army RDECOM-ARDEC, Attn: AMSRD-AAR-MEE, Bldg 321, Picatinny Arsenal, NJ 07806-5000.
AUTHORITY
Army RDECOM-ARDEC, Attn: AMSRD-AAR-MEE ltr dtd 14 apr 2009

THIS PAGE IS UNCLASSIFIED

UNCLASSIFIED

AD NUMBER
ADA134347
NEW LIMITATION CHANGE
TO Distribution authorized to U.S. Gov't. agencies and their contractors; Administrative/Operational Use; 23 JAN 2009. Other requests shall be referred to CDR US Army RDECOM-ARDEC, Attn: AMSRD-AAR-MEE, Bldg 321, Picatinny Arsenal, NJ 07806-5000.
FROM Approved for public release, distribution unlimited
AUTHORITY
Army RDECOM-ARDEC, Attn: AMSRD-AAR-MEE ltr dtd 23 Jan 2009

THIS PAGE IS UNCLASSIFIED

ADA 134 347

ENCYCLOPEDIA OF EXPLOSIVES AND RELATED ITEMS

PATR 2700

VOLUME 10

BY

SEYMOUR M. KAYE

ASSISTED BY

HENRY L. HERMAN



U.S. ARMY RESEARCH AND DEVELOPMENT COMMAND
TACOM, ARDEC
WARHEADS, ENERGETICS AND COMBAT SUPPORT CENTER
PICATINNY ARSENAL
NEW JERSEY, USA

1983

Copies of the “Encyclopedia of Explosives
And Related Items” can be obtained by requesting CD ROM
from the:

National Technical Information Service
(formerly Clearinghouse)
US Department of Commerce
Springfield, Virginia 22151

1-800-553-6847 USA only
703-605-6000
www.ntis.gov/FCPC

The contents of these volumes are UNCLASSIFIED

The distribution of these volumes is UNLIMITED

Neither the US Government nor any person acting on behalf of
the US Government assumes any liability resulting from the use or
publication of the information contained in this document or warrants
that such use or publication will be free from privately owned rights.

All rights reserved. This document, or parts thereof, may not be
reproduced in any form without written permission of the
Energetics and Warhead Division, WECAC, TACOM, ARDEC, Picatinny Arsenal

Library of Congress Catalogue Card Number: 61-61759

PREFACE

This volume represents a continuing effort to cover comprehensively the unclassified information on explosives and related subjects in the same manner and format as in previous volumes. The reader is urged to obtain the previous volumes and to read both the PREFACE and INTRODUCTION in Volume I in order to understand the authors' way of presenting the subject matter

In preparation for and during the writing of this Encyclopedia, the authors have consulted freely with and have had the cooperation of many individuals who contributed their expert knowledge and advice. This fact is acknowledged throughout the text at the end of the subject item. A listing of many others who have helped in various ways would be impractical

Drs J. Roth, A.P. Hardt and Mr D.E. Seeger of the private sector contributed significantly in the literature searching and writing of many of the articles in this volume. In addition, Ms R. Meredith, P. Altner, J. Blodgett, J. DePreter, M. Ng, E. Ragolski, Messrs I. Haznedari and A. Farnell of STINFO Division (Library), Messrs A. Anzalone and L. Silver of PLASTEC, all of ARRADCOM, Dover, NJ, gave unstintingly of their time and effort in such diverse supporting tasks as computerized searches and retrievals, *Beilstein* and *Gmelin* manual searches, and publication procurement, translation and reproduction services

Dr Raymond F. Walker, Energetic Materials Division Chief, provided financial support and encouragement to continue this work, as did Mr Edward J. Kolb of Headquarters, US Army Materiel Development and Readiness Command (DARCOM). Further financial support was received from the sale of volumes to non-government agencies and individuals by the National Technical Information Service, US Department of Commerce, Springfield, Va 22161

Although considerable effort has been made to present this information as accurately as possible, mistakes and errors in transcription and translation do occur. Therefore, the authors encourage readers to consult original sources, when possible, and to feel free to point out errors and omissions of important work so that corrections and additions can be listed in the next volume. The interpretations of data and opinions expressed are often those of the authors, and are not necessarily those nor the responsibility of officials of ARRADCOM or the Department of the Army

This volume has been prepared for information purposes only and neither ARRADCOM nor the Department of the Army shall be responsible for any events or decisions arising from the use of any information contained herein

In conclusion, I wish to acknowledge with gratitude the continual support and encouragement of Samuel Helf, now retired, without whose past efforts in behalf of the Encyclopedia of Explosives program, the publication of this volume would not have been possible

Seymour M. Kaye
Dover, New Jersey
January 1983

III

TABLE OF CONTENTS

	Page
Preface	I
Errata	V
List of Tables	VI
List of Figures and Illustrations	XI
Supplement to List of Books on Explosives, Propellants, Pyrotechnics and Ordnance Items	XV
 Descriptive Text of Encyclopedic Items	
U.D.C. (Unit Deflective Charge) to UZI	U 1 to U 111
V-1 to VX	V 1 to V 170
W.A. (Powder) to W-Salz	W 1 to W 86
X-4, Ruhrstahl to Xytolite	X 1 to X 27
Yaw to Yuenyaku	Y 1 to Y 3
Zabel to Z-Salz	Z 1 to Z 26
 Index for Encyclopedia Volumes 1 through 10	 A 1 to Z2

ERRATA IN VOLUME 9

p R127-L, second paragraph, second line	“(μ)” should be “(u)”
p S59-R, Section II, seventh line	insert “with” after “. . . Rankine-Hugoniot),”
p S59-R, Section II, ninth line	“is” should be “are”
p S75-L, second paragraph, sixteenth line	“ov” should be “of”
p S81-R, second paragraph, third line	“iso-energy” should be “iso-fluence”
p S81-R, second paragraph, seventh and eighth lines	“iso-energy” should be “iso-fluence”
p S147-R, Ref 12	“Burke” should be “Burkle”
p T11-L, third line	“shown” should be “show”
p T163-R, third line	“Knodrikov” should be “Kondrikov”
P T175-R, Eq (3)	$\frac{d}{dt}$ should be $\frac{d\epsilon}{dt}$
p T208-L, seventeenth line	“is” should be “it”
p T209-R, fourth paragraph, fourth line	“Hygoniot” should be “Hugoniot”
p T214-R, equation	Insert “CO + H ₂ = H ₂ O + C _s ” under “2CO = CO ₂ + C _s ”
p T214-L, equation on line twenty-four	“0.388 moles/g” should be “0.0388 moles/g”
p T216-R, equation on line twenty-eight	“p _s /p _j = (κ+1) (κ+1) = 1” should be “p _s /p _j = (κ+1)/(κ+1) = 1”

VII

LIST OF TABLES

	Page
Compatibility of Materials with UDMH	U 5
Compatibility of Materials with 50:50 Hydrazine:UDMH	U 8
Compatibility Classifications for Metals	U 17
Compatibility Classifications for Nonmetals	U 17
Trauzl Block and Drop Weight Test Values for Liquid Reaction Intermediates	U 22
Acoustic Properties of Selected Materials	U 28
Definition of Symbols	U 44
Conversion Factors	U 44
Similitude Constants and Coefficients for Various High Explosives	U 48
Similitude Constants and Coefficients for PETN and Lead Azide	U 48
Pressure Pulse Characteristics of Deep TNT Explosions	U 52
Shock Wave and Bubble Conversion Factors	U 54
Underwater Shock Wave and Bubble Energy Equivalent Weight Ratios for Underwater Explosives	U 54
Bubble Parameters for Various High Explosives	U 54
Number of Bubble Oscillations Before Bubble Reaches Surface (for a TNT Bubble)	U 54
Effect of Charge Density on the Underwater Performance of Two Explosives	U 55
Shock Wave Impulse and Energy Ratios vs Reduced Time	U 57
Parameters of Shock Wave Similarity Curve for Several Explosives	U 62
Overall Energy Balance for TNT	U 72
Experimental Underwater Expansion Work and Heat of Detonation	U 75
Composition and Properties of Explosives	U 75
Experimental and Calculated Data on Explosives	U 76
Thermodynamic Properties of Uranium	U 86
Decay History for the Uranium-Radium Family	U 87
Thermodynamic Properties of Uranium Compounds	U 91
Shock Hugoniot Data for Uranium and Its Alloys	U 91
Properties of Urea	U 98
Chemical and Physical Specification Requirements for Urea	U 101
Preparation and Properties of the Isomeric Forms of Urea Picrate	U 104
Accidental Fuel/Air Explosions	V 12
Calculated Detonation Properties	V 18
Measured Detonation Properties	V 18
Detonation Limits of MAPP-Air Mixtures by Volume	V 20
Effects of Additives and Drop Sizes on the Detonability of Heptane-Air Mixtures	V 21
Estimated Losses Using Industrial Risk Insurers Calculation Method	V 31
Selected Industrial Incidents	V 32
Temperature of Reflux Liquids	V 37
Vapor Pressure of EGDN	V 38
Heats of Vaporization of Nitrate Esters	V 41
Heats of Sublimation and Vaporization of Nitramines	V 42
Heats of Sublimation and Vaporization of TNT	V 42
Heats of Sublimation of Nitroaromatics	V 43
Heats of Vaporization of Nitroalkanes	V 44
Heats of Vaporization of Azides	V 44
Standard Enthalpies, Entropies and Gibbs Free Energies of Sublimation of Various Explosive Compounds	V 45
Detonation Velocities of Explosives	V 49

List of Tables (Continued)

	Page
Detonation Velocity Equations	V 51
Diameter Effect Data	V 54
Collection of Amatex Detonation Velocities	V 56
Detonation Velocity of Foamed PETN	V 57
Dependence of D on Charge Diameter of ANFO	V 59
Detonation Velocity of Slurry Explosives	V 59
Compositions of TATB/HMX Explosives	V 60
Detonation Properties of Five Compositions Having Different Inert Binders	V 61
Gurney Constants for 1-D Systems	V 73
Relative $\sqrt{2E}$ for 1-D Configurations	V 73
Gurney Constants for 2-D Systems	V 75
Ratios of Gurney Constants for 2-D and 1-D Configurations	V 76
Constancy of $\sqrt{2E}/D$	V 82
Comparison of Gurney Energies with Heats of Detonation	V 83
Damage Levels from Ground Vibration	V 121
Properties of Explosive Compositions With and Without Addition of EVA Binder	V 129
Vinyl Compound Toxicity	V 143
Theoretical and Semi-Empirical Computations of v_1	V 159
Specific Volumes of Detonation Products of Explosives at Low Density	V 160
Application of Jones' Method to Low Density Explosives	V 161
Wallonites	W 2
Wasamons	W 6
Classification of Hazardous Reactions Generated from the Reaction of Water with Water-Reactive Materials	W 8
Maximum Temperature Rise Exhibited by Various Substances Reacting with Water	W 10
Water Reactivities Determined by Using 20 Grams of Each Material and 10 Grams of Water	W 10
Heat of Explosion Data for TNT, Cyclonite and PETN Both Dry and Water-Filled	W 11
Effect of Physical Continuity on Water Content and Heat of Explosion of TNT	W 12
Water-Filled Benzoyl Peroxide Ignition Data	W 14
Detonability of Water-Wet Explosives	W 14
Impact Sensitivity Data for Wetted Lead Azides	W 14
Chemical Composition of Yellow Beeswax	W 21
Natural Waxes	W 22
US Government Wax Specifications	W 23
Synthetic Waxes	W 24
Man-Made/Synthetic Waxes	W 25
Effects of Insulators on Striker/Anvil on Sensitivity of RDX	W 27
Properties of Some Pelleting Materials	W 44
Sealant Compositions	W 47
Pyrotechnic Mixes Containing Waxes	W 49
Inert Simulants	W 50-51
Standard Explosives Containing Waxes	W 53
Detonation Failure Thickness	W 61
Wettersprengstoffe	W 68
Properties of Some Wetter-Sprengstoffe	W 71
Current German Federal Republic Permitted Explosives	W 72
Whistling Compositions	W 73
Chemical Properties of LASL Research Explosives	X 8
Densities and Melting Points of LASL Research Explosives	X 10

List of Tables (Continued)	Page
X-Ray Diffraction Data of a Selected Group of Inorganic Energetic Materials	X 12
X-Ray Diffraction Data for Selected Energetic Material Organic Compounds	X 13
X-Ray Crystallographic Data of Various Energetic Materials	X 16
Tabulated Computer Files of X-Ray Diffraction Data of Energetic Materials	X 17
Yonckites	Y 2
Yugoslav Weapons in Current Service	Y 3
Comparison of Physical Properties of Zinc and Zinc Oxide with Aluminum and Magnesium and Their Oxides	Z 2
Thermodynamic Properties of Zinc	Z 3
Thermodynamic Properties of Zinc Oxide	Z 3
Comparison of Various Silver-Zinc and Silver-Cadmium Battery Systems	Z 5
Purity and Size Requirements for Military Grade Zinc Dust	Z 6
Physical Properties of Zirconium, Hafnium and Titanium	Z 11
Hazard Ranges for Zirconium Particles	Z 14
Threshold Pyrophoricity Values	Z 17
Composition and Properties of Gasless Ignition Mixtures Containing Zirconium	Z 18
Standard Ignition Mixtures Containing Zirconium	Z 19
Maximum Quantity of Light Emitted by Flashbulbs	Z 22
Zirconium Hydride Specification Requirements	Z 24
Specification Requirements for Type I and Type II Zirconium-Nickel Alloys	Z 25

LIST OF FIGURES AND ILLUSTRATIONS

	Page
UDMH Decomposition Rate Data	U 3
Pressure Limit for Hypergolic Ignition of Hydrazine Based Fuels with N_2O_4	U 17
Physical Properties of UDMH	U 20
Physical Properties of Aerozine-50	U 21
H-Film Silent Sterilization Mine Concept	U 23
Schematic Drawing of Flueric Match	U 30
Dependence of Temperature Rise in Flueric Matches on Gas Pressure	U 30
Straight Line Cutter	U 36
Inside Circular Cutter	U 36
Outside Circular Cutter	U 37
H-Beam Cutter and Severed H-Beam	U 37
Large Conical Shaped Charge Designed for Pipeline Trenching	U 37
Pressure Waves and Bubble Phenomena of Underwater Explosions	U 39
Definitions of Shock Wave Parameters	U 40
Pressure Distribution Around a 300-Pound TNT Charge	U 41
Radius of Gas Sphere as a Function of Time	U 41
Pressure-Pulse Characteristics of Deep Explosions	U 43
Underwater Test Configuration	U 45
Charge Shapes and Charge Shape Factors	U 46
Underwater Shock Wave Parameters from a TNT Charge	U 51
First Period and Maximum Radius of an Underwater Gas Bubble (TNT)	U 53
Effect of Aluminum on the Underwater Power of Explosive Mixtures	U 55
Shock Velocity vs Reduced Distance	U 56
Pressure vs Reduced Distance	U 56
Shock Front Around a Line Charge Detonated at One End	U 58
Peak Pressures for Line Charges as a Function of Distance from the Nearest Point of the Charge	U 58
Formation of a Shock Front in a Plane Wave of Finite Amplitude	U 60
Calculated Peak Pressure and Time Constant for TNT	U 62
Shock Wave Velocity Measurements for Small Charges	U 63
Shock Front Pressures from Velocity Data Compared with Theory and Piezoelectric Gauge Measurements	U 63
Calculated Peak Pressure at the Side of a Cylindrical TNT Charge	U 65
Calculated Time Constants at the Side of a Cylindrical TNT Charge	U 65
Peak Pressures Produced by Line Charges	U 66
Shock Wave Energies Produced by Line Charges	U 67
Calculated Peak Shock Pressure vs Distance for Explosions in Water	U 68
Measured and Calculated Radius of the Gas Sphere from a Detonator One Foot Below the Surface	U 70
Energy Dissipation in the Spherical Shock Wave from TNT	U 71
Calculated Energy Partition vs Position of the Main Shock, for Explosives in Water	U 71
Variation of Energy Dissipation with Shock Pressure	U 72
Correlation Between Underwater Values and Trauzl Lead Block Values	U 73
Histogram of Underwater Energies	U 74
Separated Charge Arrangement and Sketch of Shock Wave Positions at the Point of Mach Wave Formation	U 78
Typical Pressure Pulses Affected by Surface Reflection	U 79
Destructor Explosive, Universal, M10	U 84

List of Figures and Illustrations (Continued)	Page
Price Structure of Enriched Uranium	U 88
Critical Masses of Uranium and Plutonium	U 89
Once-Through Urea Process	U 96
Chemico Total-Recycle Urea Process	U 97
UZI 9mm Submachine Gun	U 110
Typical Test Curves of Pressure and Temperature Versus Time	V 2
Calculated Peak Overpressure Vs Dimensionless Radius	V 8
Calculated Static Impulse Vs Dimensionless Radius	V 8
Calculated Dynamic Impulse Vs Dimensionless Radius	V 9
Calculated Final Energy Distribution of the Product Cloud Vs Dimensionless Radius	V 9
Time Dependent Histories of the Detonation Wave Front Shape and Pressure	V 10
Peak Pressures Produced by Ethylene Oxide and Pentolite Detonations	V 11
Impulses Produced by Detonations from Spherical and Cylindrical Clouds of Ethylene Oxide	V 11
Calculated Detonation Pressure	V 19
Experimental Mach Number-Radius Data	V 19
Effect of Additives on the 1400 Micron Heptane Drop Mixtures Wave Velocities	V 21
Phenomena Associated With Breakup of Fuel Drops in a Two Phase Detonation	V 23
Experimental Setup in a Vacuum System for Testing the Delayed Ignition of Spontaneously Ignitable Gases	V 24
Ignition Curves for TMA-Decane Mixtures	V 26
Weight Loss Measurement Technique	V 34
Effusion Cell	V 36
Schematic Diagram of Vapor Concentrations	V 37
Collection of Equilibrium Vapor Concentrations	V 37
Vapor Pressure of 2,4,6-TNT	V 39
Vapor Pressure of RDX	V 39
Diameter Effect Results for Amatex	V 56
Detonation Velocity and Density of NM-UPS Mixture	V 59
Detonation Velocities of TATB-HMX Mixtures	V 61
Binder Effect on Detonation Velocities	V 62
Explosive/Metal Slab	V 63
Comparison of Gurney Calculations with Experimental Data for Octol Filled Cylinders	V 74
Theoretical and Experimental Plate Velocities	V 80
Theoretical and Experimental Plate Accelerations	V 85
Three-Dimensional View of a Bench Blast	V 88
Plan View of a Bench Blast	V 88
Predictive Accuracies of Models	V 89
Schematic for Determining Particle Velocity from Free Surface Velocity Measurements	V 96
Wedge Technique for Measuring Free-Surface Velocity and Shock Velocity	V 97
Laser Interferometer System	V 98
Schematic Drawing for EMV Gage Measurements	V 99
Configuration of Embedded Particle Velocity Gage TNT Experiments	V 101
Particle Velocity Histories	V 101
Particle Velocity Profiles for H ₂ /O ₂ Detonations	V 105
Velocity Measurement with Staggered Array of Detectors	V 109
Circuit for Breakwire System	V 110
Make Circuit System	V 111
Solenoid Output Waveform	V 112
Radar Velocity Measurement Schematic	V 113

List of Figures and Illustrations (Continued)	Page
Radar Velocity and Displacement Schematic	V 114
Photographic Method for Velocity Measurement	V 115
Schematic of the Fracturing and Deformation Around an Explosion in Rock	V 119
Typical Values of Peak Particle Velocity as a Function of Scaled Distance for Blasting to a Free Face	V 120
The Two Modes of Viper	V 144
GC Scan of a Typical Single-Base Propellant Extract	V 154
GC Scan of a Typical Multi-Base Propellant Extract	V 154
Structure of Systems Analysis for Munition Effectiveness	V 168
Elements of Target Vulnerability Analysis	V 169
Walther Model P-38 Pistol	W 5
Water Electrolysis System Propulsion System	W 15
Impact Sensitivity of RDX/Polyethylene Wax Compositions	W 33
Shock Sensitivity of RDX/Polyethylene Wax as a Function of Density	W 34
Shock Sensitivity of RDX/Polyethylene Wax as a Function of Wax Content	W 35
Density of RDX/Polyethylene Wax as a Function of Wax Content	W 45
Minimum Failure Thickness Test Assembly	W 61
Experimental Arrangement for Most Wedge Test Shots	W 62
Typical Smear Camera Wedge Record	W 63
Effect of Open Tube Length on Whistle Frequency	W 74
Effect of Whistle Frequency on Burning Rate	W 74
Effect of Whistle Diameter on Acoustic Output	W 75
Effect of Whistle Composition on Acoustic Output and Burning Rate	W 75
Effect of Pressure on Whistle Burning Rate	W 76
Diagram of Xenon Flash Heating Apparatus	X 3
Variation of the Time to Explode Versus Particle Size for Flash-Ignited Particles	X 4
Axes of Symmetry in a Cube	X 18
Planes of Symmetry	X 19
XTX-8003 DTA and Pyrolysis Test Results	X 22
XTX-8004 DTA and Pyrolysis Test Results	X 23
Section of a Trajectory with Yaw Oscillations	Y 1
Maximum Container Size for Safe Handling of Zirconium	Z 14
Dependence of Ignition Temperature of Zirconium on Particle Size	Z 15
Light Output from Stoichiometric Mixtures of Barium Nitrate with Various Fuels	Z 21

**SUPPLEMENT TO THE
LIST OF BOOKS ON EXPLOSIVES, PROPELLANTS, PYROTECHNICS AND ORDNANCE ITEMS
GIVEN IN VOL 1, p A676; VOL 2, pp C215 to C216; VOL 3, pp XIV to XV; VOL 4, pp LI to LV;
VOL 5, pp XIV to XV; VOL 6, p X; VOL 7, pp XI to XII; VOL 8, p XV; and VOL 9, pp XIII to XIV**

- P. L. Gallina, "Le Moderne Polveri Da Caccia E Da Tiro", Editoriale Olimpia, Firenze, Italy (1979)
- H. Krier & M. Summerfield, Eds, "Interior Ballistics of Guns", Vol 66 of Progress in Astronautics and Aeronautics, American Institute of Aeronautics and Astronautics (no address) (1979)
- I. Berman & J.W. Schroeder, Eds, "Explosive Welding, Forming, Plugging, and Compaction", The American Society of Mechanical Engineers, New York, NY (1980)
- W. Bartknecht, "Explosionen, Ablauf und Schutzmaßnahmen", Springer-Verlag, New York, NY (1980)
- T.R. Gibbs & A. Popolato, Eds, "LASL Explosive Property Data", Univ of California Press, Berkeley, Calif (1980)
- C. Capellos & R.F. Walker, Eds, "Fast Reactions in Energetic Systems", D. Reidel Publishing Co, Boston, Mass (1980)
- G. Weiss, Ed, "Hazardous Chemicals Data Book", Noyes Data Corp, Park Ridge, NJ (1980)
- D. Harding, Ed, "Weapons", St Martin's Press, New York, NY (1980)
- H. J. Yallop, "Explosion Investigation", The Forensic Science Society and Scottish Academic Press, Ltd, Edinburgh, Scotland (1980)
- F.T. Bodurtha, "Industrial Explosion Prevention and Protection", McGraw-Hill, New York, NY (1980)
- S.P. Marsh, "LASL Shock Hugoniot Data", Univ of California Press, Berkeley, Calif (1980)
- C.L. Mader, "LASL Phermex Data", Vols 1 and 2, Univ of California Press, Berkely, Calif (1980)
- A.K. Oppenheim, Ed, "Gas Dynamics of Explosives and Reactive Systems", Pergamon Press, New York, NY (1980)
- M. Kimura, "Handbook on Handling of Gunpowder", National Diet Library, Tokyo, Japan (1980)
- G.S. Biasutti, "History of Accidents in the Explosives Industry", Self Publishing House, Case Postale 312, 1800 Vevey, Switzerland (1980)
- B.M. Dobratz, "LLNL Explosives Handbook, Properties of Chemical Explosives and Explosive Simulants", UCRL-52997, Lawrence Livermore Laboratory, Univ of California, Livermore, Calif (1981)
- S.J. Jacobs, Chairman, "The Seventh Symposium (International) on Detonation", Vols 1 & 2, US Naval Academy, Annapolis, Md (June 16-19, 1981)
- M. Settig, "Handbook of Toxic and Hazardous Chemicals", Noyes Publications, Park Ridge, NJ (1981)

R. Meyer, "Explosives", 2nd revised and extended edition (Engl), Verlag Chemie, Deerfield Beach, Florida (1981)

R.T. Barbour, "Pyrotechnics in Industry", McGraw-Hill, New York, NY (1981)

L. Bretherick, Ed, "Hazards in the Chemical Laboratory", 3rd Ed, Royal Society of Chemistry, London, Engl (1981)

J. Yinon & S. Zitrin, "Analysis of Explosives", Vol 3, Pergamon Press Series on Analytical Chemistry, Pergamon Press, New York, NY (1981)

J. Hansson, Ed, "Proceedings of Pyroteknikdagen 1980, Stockholm (April 15, 1980)", Sektionen foer Detonik och Foerbraening Svenska Nationalkommitten foer Mekanik, Joenkoeping, Sweden (1981)

W. Selig, "Some Analytical Methods for Explosives and Other Organic Materials, Part VI", UCRL-7873, Lawrence Livermore Laboratory, Univ of California, Livermore, Calif (1980)

S. Fordham, "High Explosives and Propellants", 2nd Ed, Pergamon Press, New York, NY (1980)

A.P. Hardt, "Pyrotechnics", in Kirk-Othmer, "Encyclopedia of Chemical Technology", Vol 19, 3rd Ed, 484-499, John Wiley & Sons, New York, NY (1982)

U

U.D.C. (Unit Deflective Charge). The "unit deflective charge" for an expl is the wt of the expl that has been found to deflect the pendulum of the BuMines ballistic pendulum to the same degree that a standard wt of BuMines standard PTSS Dynamite (see Vol 1, VII-VIII under Ballistic Pendulum Test) has deflected it in a previous test. The U.D.C. for permissible expls shall not exceed 454g (1 lb)

Ref: C.E. Munroe & J.E. Tiffany, "Physical Testing of Explosives at the Bureau of Mines Explosives Experiment Station, Bruceton, Pa", USBuMines Bull **346** (1931), 40 & 45

UDMH (Unsymmetrical dimethylhydrazine, 1,1-Dimethylhydrazine or Dimazine). See in Vol 5, D1344-L to D1346-R; in Vol 7, H203-R to H204-L and under "Liquid Propellants" in Table 3, L40 to L41. *Addnl Refs* on this compd and mixts contg it are listed next:

General: Beil 4, 547 (560) & [958]

Accidents: 1) Anon, "Missile Silo Blows in Arkansas", Daily Record **81** (73), 1, Morristown (Sept 19, 1980) 2) Anon, "A Missile Silo Blast Kills 1, Injures 22", The Star-Ledger **67** (204), 1 & 7, Newark (Sept 20, 1980) 3) Anon, "A 'Titan' of Defense is Proving Vulnerable", Ibid 4) W. Rawls, Jr, "One Killed in Blast at Missile Silo", The New York Times **CXXX** (44, 712), 1 & 8, NYC (Sept 20, 1980) 5) F.X. Clines, "Hamlet's Fright Turns to Anger", Ibid 6) A.O. Sulberger, Jr, "Safety of Aging Missile System Questioned", Ibid, p 8 7) Anon, "Names of Missile Blast Casualties", Ibid

[According to Refs 1, 2 and 4, Aerozine-50 (UDMH/hydrazine-50/50 wt %) is used as the first stage fuel in the ICB Titan Missile system. This fuel provides a minimal "make-ready" and launch time as compared to a solid propnt system. However, since 1975 there have been 125 reported accidents involving complete missile systems using this fuel. Indeed, ref 3 reports that, "Two airmen have been killed and nearly 80 injured, some seriously, as the result of leaks in the missiles' fuel and propulsion systems and other accidents.

In addition, there have been hundreds of small incidents in the past five years, most of them unreported to the public, and a number of close

calls.

In August, 1979, for example, a metal rod dropped on an electric circuit-breaker in a Titan silo near Heber Springs, Ark., causing a fire. While the flames were being extinguished, the oxidizer and fuel in the missile heated up, creating great pressure. . . ." Also, according to ref 6, ". . . Since 1963, when the first of the nation's 54 Titan II's was deployed, 55 persons have died and scores have been injured in hundreds of accidents involving the missiles . . ."

The latest accident at the time of this writing occurred at Damascus, Arkansas on Sept 19, 1980. The sequence of events describing this accident are as follows (Ref 4), ". . . A maintenance team was working last night at the third level of the 103-foot-tall Titan missile, pressurizing the second stage. A technician dropped a three-pound wrench socket that fell 70 feet, bounced off a thrust mount and struck the missile, rupturing the thin skin of a fuel tank.

The crew noticed fuel vapors escaping, and within 24 minutes, shortly after 8 P.M., the crew in the command control area had indications of fire in the silo and loss of fuel tank pressure.

The maintenance crew evacuated the silo immediately, and the concentration of fuel vapors in the air continued to rise.

When it reached a certain point of mixture with the air, another automatic safety sequence was initiated: 100,000 gallons of water was sprayed into the silo, washing down the sides of the missile.

However, the water rose only as high as the fire deflector in the bottom of the silo, which was not high enough to cover the engines or the fuel tank.

Fuel continued to leak out of the tank and vaporize, and the pressure continued to build.

The crew then evacuated from the control area and alerted local officials to evacuate an area within a two-mile radius of the site. It was 10 P.M.

Meanwhile, Sheriff Gus Anglin of Van Buren County, who suffered acid burns in a fuel leak two years ago, had begun alerting residents within four miles of the silo that they might have to leave their homes.

Shortly before 11 o'clock, an emergency action team of the Air Force Strategic Air

Command was mobilized and arrived at the site in the early morning hours. Two members of the team entered the access chamber to the silo and started to go into the silo proper to try to control the fuel leak.

When they opened the door to the silo, about 2:30 A.M., they saw and subsequently measured a highly dangerous level of vapor. They immediately retreated, and, as they reached the ground surface of the access chamber, at 3:01 A.M., the fuel exploded . . .”

This accident resulted in one death and 21 injuries (Ref 7)

As a result of the series of accidents associated with the Titan II system the following statements were made on Sept 20, 1980 by several US Senators and Congressmen, “. . . ‘If it’s not safe and effective, I don’t know why we need it,’ said Senator Bob Dole, the Republican from Kansas who has been the most outspoken critic of the Titan.

Senator David Pryor, Democrat from Arkansas who on Tuesday successfully amended a Senate bill to require the Air Force to install alarm systems at all Titan II sites near population centers, said, ‘It’s time not just to move ahead with installing the warning devices but to take a critical look at the safety of the entire Titan II system.’ . . .”]

Analysis and Detection: 1) C.A. Plantz, “Colorimetric Personal Dosimeter for Hydrazine Fuels”, **AMRL-66-162**, Mine Safety Appliances Co, Pittsburgh, Contract AF 33 (615)-2929 (1967) [The use of bindone [$(\Delta^{1,2'}\text{-biindan})\text{-}1',3,3'\text{-trione}$] uniformly dispersed on Eastman chromagram sheet (type K301R2) was selected as the sensing element for use in a dosimeter badge. The badge is designed to be sensitive to UDMH vapor in the range of 100 to 1800ppm-min. According to the author, the purple color evolved in consequence to the reaction with UDMH changes only slightly during a period of 12 hrs after exposure. The developed color is linear to the concn-time of exposure and is indexed by means of synthetic color stds included in the dosimeter package] 2) C.R. Townsend et al, “Thin Film Personal Dosimeters for Detecting Toxic Propellants”, CFSTI (1967) (AD 652849) & CA 68, 32961 (1968) also, 3) H.P. Silverman & G.A. Giarrusso, USP 3549329 (1970) & CA 74, 90882 (1971)

[Essentially the same instrument is reported by both sets of workers for the detection in air of UDMH in the 10 to 100ppm ($\pm 20\%$) range. The UDMH vapor sensitive sensor is a thin gold film coated with a layer of reducible metal salt such as KAuCl_4 or AuI . The change in electrical resistivity of the salt-Au couple, as measured by means of a Wheatstone bridge, or similar device, is a function of the concn of UDMH vapor] 4) H.E. Malone, “The Analysis of Rocket Propellants”, Academic Press, NY (1976), 66 & 129–30 [Reported are five analytical techniques. The first, for the determination of UDMH in the presence of hydrazine and diethylenetriamine, consists of dissolving the sample in acetic acid, adding salicylaldehyde and then using 0.1N perchloric acid in dioxane as the titrant and crystal violet as the indicator. The hydrazine forms a neutral azine, UDMH forms a basic hydrazone and diethylenetriamine forms a Schiffs base in which only the secondary amine is basic. The second procedure involves the use of a high frequency electronic technique (dielectric constant oscillometry) for the assay of water in UDMH in the range of from 0 to 5% with an accuracy of 0.02%. Another procedure in this same area incorporates the use of 4Å molecular sieves. The sieves are added to one-half of the UDMH sample and then both halves are compared using an oscillometer after one hr. A third technique involves gas chromatography to separate water from UDMH. The fourth assay procedure is also used to determine water in UDMH, but by differential spectrophotometry at 1.9 nanometers. Water concns of from 0.1 to 15 wt % are detd. The fifth analysis technique is a near IR procedure which can be used to determine water in UDMH and diethylenetriamine, or the individual compds in a mixt. This technique calls for drying the sample in a liq drying column using Linde 4Å molecular sieves (water detn), and then using the near IR spectrum between 2.2 and 1.7 micrometers to determine the ratio of UDMH to diethylenetriamine] 5) H.N. Voltrauer, “Hydrazine Analysis Using Chemiluminescence”, **SAM-76-37**, Aero Chem Res Lab, Princeton, Contract F41609-76-C-0029 (1976) [A procedure is reported using the chemiluminescent reactions of ozone with monomethylhydrazine and Aerozine-50 (UDMH/hydrazine in 50/50 wt %) to

determine these materials in a mixt in the range of from 0.1 to 1000ppm in air. The procedure per se involves a sampling device-reactor assembly with a set of operating conditions such that the operating pressure is 200Torr, sample flow rate is 3ml/sec, ozone flow rate is 20 ml/sec, ozone concn at the reactor is 0.1% and reactor temp is 80 to 100°. The assembly is coupled with a UV spectrophotometer which records data at a spectral range of from 400 to 760 nanometers. The following calcn is then used to find the concn of Aerozine-50:

Concn of Aerozine-50 in arbitrary units =
4.85 (light intensity at 760 nanometers) –
2.01 (light intensity at 400 nanometers)]

Combustion. 1) I.J. Eberstein & I. Glassman, "The Gas-Phase Decomposition of Hydrazine and its Methyl Derivatives", TenthIntSympCombstn, Combstn Institute, 365–74 (1965) [Using an electrically heated quartz reactor with a conical nozzle and hot N₂ as the carrier gas, the authors obtd the decompn rate data shown in Fig 1. They also report that UDMH has the fastest reaction rate of the compds examined, including mono-methylhydrazine (MMH) and hydrazine. To support their results they quote from Kerr et al [JCS, 3217 (1963)] that the N-N bond strength of UDMH is 49.6kcal/mole, while MMH is 51.9 and hydrazine is 57.1kcal/mole]

2) S.S. Cherry et al, "Identification of Important Chemical Reactions in Liquid Propellant Rocket Engines", Pyrodynamics 6 (3–4), 275–96 (1969) & CA 70, 98394 (1969) [The authors state that the kinetics of nonequilibrium expansion of the proplnt system N₂O₄/A-50 (UDMH 49 plus hydrazine 51 wt%) can be described by the following gas phase reactions with an accuracy such that not more than 0.5 lb force-sec/lb mass variation in specific impulse (at a nozzle expansion rate of 40) is produced, as compared to the results of a full kinetic analysis:

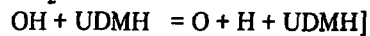
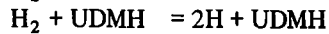
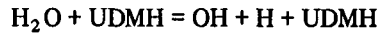

3) D.S. Ross et al, "Study of the Basic Kinetics of Decomposition . . .", AFRPL-70-29, SRI, Menlo Park, Contract F04611-69-C-0096 (1970) [From their work the authors conclude that there is no way to distinguish between the very low pressure pyrolysis reactions UDMH → NH₃+CH₂:N-CH₂ (1) and UDMH → (CH₃)₂N. +NH₂ (2). The reported pyrolysis fall-off rate constants k_x are listed as log k₍₁₎ = 13.0 – 49 / 2.303RT x 10⁻³kcal/mole, and log k₍₂₎ =

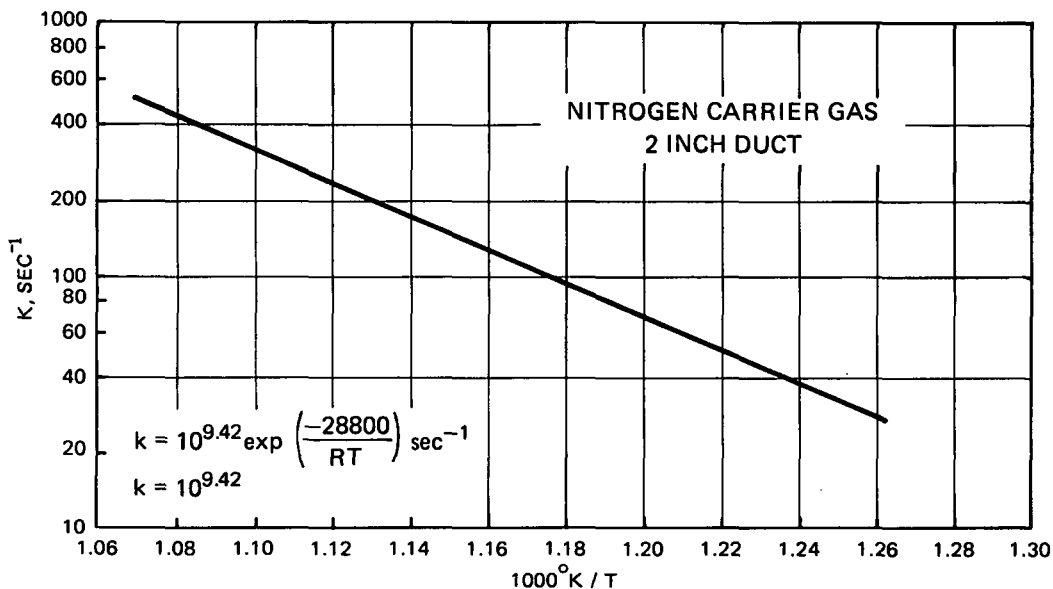

Fig 1 UDMH Decomposition Rate Data

16.1 - 58 / 2.303RT x 10⁻³ kcal/mole, where k is in inches/sec] 4) C.B. Allison & G.M. Faeth, "Decomposition and Hybrid Combustion of . . . UDMH . . . as Droplets in a Combustion Gas Environment", *Combustn&Flame* **19** (2), 213-26 (1972) & *CA* **78**, 45840 (1973) [The combustn characteristics of UDMH in droplet form were investigated at atm pressure. The authors conclude from their investigation that droplets capable of hybrid combustn show increasing burning rates (in general) with increasing diameter, ambient oxygen concn and ambient temp. However, the effects of ambient oxygen concn and ambient temp on the burning rate of UDMH is only evidenced at the largest droplet size] 5) G.B. Guarise et al, "Transport Properties of Combustion Products. RFNA . . . UDMH . . . Propellant System", *AttiIstVeneto-SciLettArticlSciMatNat* 1973 (Ital), 132 & 103-14 (1974) & *CA* **83**, 208113 (1975) [A computer program devised by R.A. Svehla in 1962 was used to calculate the thermal flux of the RFNA/UDMH proplnt system in rocket chambers by using the heat-transfer properties of the proplnt's combustn gases. The calcd values were found to be close to those exptly detd in a rocket motor] 6) I. Sargato & G. Guarise, "Propellant Flames Under Pressure", *ProcInt-ConfHighPress*, 4th, 1974", 840-44 (1975) & *CA* **83**, 82252 (1975) [The system RFNA/UDMH was examined in a rocket motor of 100daN thrust. The optimum pressure for this system was found to be ~7 x 10⁶ Pascals. At one atm the H₂-O₂ flame was almost invisible, but under increased pressure a bright, bluish-white light was emitted because of a flame continuum. This flame continuum was concluded as being the emission from transient, excited species characterized by the nonequilibrium state]

Compatibility. 1) W.K. Boyd et al, "Compatibility of Materials with Rocket Propellants and Oxidizers", *DMIC Mem* **201**, Battelle Mem Inst, Columbus, Contract AF 33 (615)-1121 (1965) & *CA* **67**, 23666 (1967) [UDMH compatibility data reported is summarized in Table 1. The compatibility data for UDMH/hydrazine (50/50 wt %) is summarized in Table 2. The explanation of the numeric evaluation code used in these tables for metals is presented in Table 3; for nonmetals in Table 4

2) M.J. Spanger & T.J. Reinhart, Jr, "Development of Filament-Wound Tankage for Rocket

Oxidizers and Fuels", *AdvancedStructCompos-SocAerospacMaterProcessEngrgNatnlSymp-Exhib*, 12th, A8-7 (1967) & *CA* **70**, 79464 (1969) [The authors report that annealed type 347 stainless steel is compatible with UDMH at 75-200°F under vac with no discernible degradation or corrosion occurring] 3) L. Raymond & R.J. Usell, Jr, "The Effect of N₂O₄ and UDMH on Subcritical Crack Growth in Various High-Toughness, Low Strength Steels", *SAMS0-71-106*, Aerospace Corp, El Segundo, Contract F 04701-70-C-0059 (1971) & *CA* **75**, 154301 (1971) [Investigation of the compatibility of four high-toughness steels (T-1, HY-140, HP-9-4-20 and 18 Ni (200) Maraging) with N₂O₄ and UDMH proplnts is reported. The compatibility was evaluated by general corrosion and stress corrosion tests at temps up to 120°F. Weight-loss tests were not conducted in UDMH, but by observing the surface of the stress-corrosion specimens in UDMH, the authors concluded that some observations regarding general corrosion could be made. For example, all four steels in UDMH showed some degree of pitting. Also, stress corrosion tests were conducted on fatigue-precracked, contoured, double-cantilever beam (DCB) specimens. No crack growth was observed in UDMH to temps of 120°F. In all four steels the weld metal was found to be equally resistant to crack propagation and demonstrated 100% joint efficiency in both strength and toughness] 4) J.K. Stanley, "Deterioration of Stainless Steel Regeneratively Cooled Thrust Chambers", *JSpacecrRkts* **8** (4), 329-34 (1971) & *CA* **75**, 8984 (1971) [The author concludes from his study that failure of type 347 brazed stainless steel tubing is caused by carburization (embrittlement, from the decompn products of UDMH)] 5) L.R. Toth & J.C. Lewis, "Effect of Chloride Ion Content in Unsymmetrical Dimethylhydrazine Propellant on Future Properties of Structural Alloys", (1976) (AD-A022577) & *CA* **85**, 147721 (1976) [Reported are results of a study to determine the effect of the Cl⁻ content of UDMH on 2014T6 Al alloy, Ti-6Al-4V Ti alloy and type 304L steel. Sustained load tests were conducted at 49° with thin and thick gage tensile specimens with a semielliptical surface flaw. No effect on the sustained load stress corrosion crack growth properties was found because of the Cl⁻ environment]

Table 1
Compatibility of Materials with Unsymmetrical Dimethyl Hydrazine (UDMH)

Material	Temperature, °F							
	Gas				Liquid			
	Class 1	Class 2	Class 3	Class 4	Class 1	Class 2	Class 3	Class 4
Metals								
Aluminum, 1100					160			
Aluminum, 1100-H14					145			
Aluminum, 1260-H14					145			
Aluminum, 2014	140		160		140			
Aluminum, 2017	75	160			75	160		
Aluminum, 2024	75	160			75	160		
Aluminum, 2024-T3					145			
Aluminum, 2024-T3 (Iridited)					86			
Aluminum, 3003	75	160			86	160		
Aluminum, 3003-H14					145			
Aluminum, 3004-H34					145			
Aluminum, 5052	140				160			
Aluminum, 5052-H34					145			
Aluminum, 5086					86			
Aluminum, 5086-H34					145			
Aluminum, 5154-H34					145			
Aluminum, 5456	140	160			140	160		
Aluminum, 6061	75	160			160	160		
Aluminum, 6061-T6					145			
Aluminum, 6063-T6					145			
Aluminum, 7075	160				160			
Aluminum, 7075-T6					145			
Aluminum, 43					145			
Aluminum, 356	75	140	160		160	140		
Aluminum, 356-T6					85	145		
Aluminum, 3003 (Anodized)	75	160			75	160		
Aluminum, 5052 (Welded to 356)	75	160			75	160		
Aluminum, 5052 (Welded to 6061)	75	160			75	160		
Cadmium Plate								75
Haynes Alloy 25					145			
Copper					145			75
Brass					75		160	75
Bronze							160	75
Mild Steel					140			
4130	75	160			85	160		
Chromium Steel	75	160			75	160		
302 Stainless Steel					160			
303 Stainless Steel	140				160			
304 Stainless Steel	140				160			
316 Stainless Steel	140				140			
321 Stainless Steel	140				160			
347 Stainless Steel	160				160			

(continued)

Table 1 (continuation)

Material	Temperature, °F							
	Gas				Liquid			
	Class 1	Class 2	Class 3	Class 4	Class 1	Class 2	Class 3	Class 4
410 Stainless Steel	160				160			
416 Stainless Steel					250			
422 Stainless Steel					145			
17-7PH	160				160			
PH15-7Mo					85			
A-286					85			
Carpenter 20	140				140			
AM-355 CRT					100			
Magnesium, Dowmetal 032					75			
Magnesium, AZ92F					85			
Magnesium, AZ31BO					85			
Magnesium, AZ31B					130			
Magnesium, AZ61A					130			
Magnesium, AZ91C					130			
Magnesium, AZ92A					130			
Magnesium, ZK60A					130			
Magnesium, AM100A	140				140			
Magnesium, Dowmetal					140			
Molybdenum						86		
Nickel					140			
Monel	140				140			
Inconel	140				140			
Hastelloy B					145			
Hastelloy C					145			
Hastelloy F					145			
Hastelloy X					145			
Rene 41					85			
Tantalum	140				140			
Tin Plate								75
Titanium, A55					145			
Titanium, A110AT					130			
Titanium, B120VCA					145			
Titanium, C120AV	160				160			
Zinc								75
Nonmetals								
Alathon					80			
Buna N Rubber				75				32
Acid Seal Rubber								75
Butyl Rubber			75	130	140		75	130
Buna S								75
DC-152								75

(continued)

Table 1 (continuation)

Material	Temperature, °F							
	Gas				Liquid			
	Class 1	Class 2	Class 3	Class 4	Class 1	Class 2	Class 3	Class 4
Disoyrin								<140
Fluororubber								75
Garlock Red Rubber								75
Hydropol V							160	
Hydropol T						85		
Kel-F-X300				<140				<140
Kel-F-5500								80
Kel-F-3700								80
Neoprene								32
Poly FBA								80
Silicone Rubber				32				32
Thiokol C 55935						85		
Vynylite				32				32
Firestone 0-432						85		
Parker 37-014						85		
Precision 925-70						85		
Stillman 613-75						85		
Chicago Rawhide 20316-70								85
Silicone DC15								85
Butyl 218						75		160
Butyl 325								75
Butyl 035								75
Precision Butyl MD551								160
								75
Polybutadiene						75		160
Hydropol						160		
Hycar 2202								75
SBR						75		
Nylon					130			
Polyvinyl Chloride								85
Polyethylene					80			160
Polyvinyl Acetate								75
Teflon FEP, TFE	160				160			
Furan Resin					75			
Phenolic Resin								75
Kel-F 300-25				140				140
Kel-F Unplasticized	140				140			
Kel-E-1								140
Kel-E-5								140
Mylar								75
Tenite								75
Tygon								75

(continued)

Table 1 (continuation)

Material	Temperature, °F							
	Gas				Liquid			
	Class 1	Class 2	Class 3	Class 4	Class 1	Class 2	Class 3	Class 4
Vistonex								80
Isocyanate Polyester								75
Acrylonitrile Butadiene Copolymer								75
PVC-PVD Copolymer								75
Butadiene-Styrene Copolymer								75
PVC-PVA Copolymer								75
Cellulose Acetate Butyrate								75
Polyfluorochloroethylene								75
Polyvinyl Alcohol Polymer								75
Epon 815								140
Carum 200							75	
Carum 325								75
Genetron HL							140	
Genetron GCX-3B								140
Rathene N							140	
Andok C							75	
Garlock Gasket No 900							140	
Organic Polysulfide								75
Diallylphthalate								75
Delanium					75			
Johns-Manville Svc No 60							140	
Dapon 35							140	
Silastic LS-53								75
Glass Pyrex	160				160			
Fiberglas Polyester Binder								75
Graphitar No 2					140			
Graphitar No 50							140	

Table 2

Compatibility of Materials with 50:50 Hydrazine:Unsymmetrical Dimethyl Hydrazine (N₂H₄:UDMH)

Material	Temperature, °F							
	Gas				Liquid			
	Class 1	Class 2	Class 3	Class 4	Class 1	Class 2	Class 3	Class 4
Metals								
Aluminum, 1100					60*			
Aluminum, 1100-0					60			
Aluminum, 2014-T4					60			
Aluminum, 2014-T6	160				160			
Aluminum, 2014-T6 (Welded)	160	60			160	60		

Footnote to Table 2:

* - Over 60°F with up to 3% water added

(continued)

Table 2 (continuation)

Material	Temperature, °F							
	Gas				Liquid			
	Class 1	Class 2	Class 3	Class 4	Class 1	Class 2	Class 3	Class 4
Aluminum, 2014-T6 (Spot Welded)								60
Aluminum, 2014-T6 (Extrusion)	160				160			
Aluminum, 2014-T6 (Extrusion Stressed to 30,000 psi)					60			
Aluminum, 2014-T6 (Welded and Stressed to 30,000 psi)					60			
Aluminum, 2014-T6 (Hardas Anodize)					60			
Aluminum, 2014-T6 (H ₂ SO ₄ Anodize)	160				160			
Aluminum, 2014-T6 (Iridite)					60			
Aluminum, 2014-T6 (Alodine)		160				160		
Aluminum, 2014-T6 (Fluoride)					80			
Aluminum, 2024-T6	160				160			
Aluminum, 2219-T81					60			
Aluminum, 2219-T81 (Welded)					60			
Aluminum, 3003-H14	150				150			
Aluminum, 5086-H36	160				160			
Aluminum, 5086-H36 (Welded)					160			
Aluminum, 5254-F	160				160			
Aluminum, 5456-H24					60			
Aluminum, 5456-H24 (Welded)					60			
Aluminum, 5456-H321	160				160			
Aluminum, 5456-H321 (Stressed 30,000 psi)					60			
Aluminum, 5456-H321 (Welded)	60				60			
Aluminum, 5456-H321 (Welded and Stressed to 30,000 psi)	60				60			
Aluminum, 6061-T6	160				160			
Aluminum, 6061-T6 (Welded)					160			
Aluminum, 6061-T6 (H ₂ SO ₄ Anodize)	160				160			
Aluminum, 6061-T6 (Alodine)	160				160			
Aluminum, 6066	160				160			
Aluminum, 7075-T6	160				160			
Aluminum, 7075-T6 (Stressed to 80% of Yield)					160			
Aluminum, 356	160				160			
Aluminum, 356-T6	60							
Aluminum, Tens 50	160				160			
Berylco 25	160				160			
Cadmium Plate								60
Chromium Plate					60			
Stellite 25	160				160			
Stellite 6K	160				160			
Stellite 21	160				160			
Copper Plate								60

(continued)

Table 2 (continuation)

Material	Temperature, °F							
	Gas				Liquid			
	Class 1	Class 2	Class 3	Class 4	Class 1	Class 2	Class 3	Class 4
718 Filler Braze of 6061-T6 A1					160			
AMS 4775 Microbraze of 347 Stainless Steel					160			
C-62 Braze (Mo-Ni-Co) of 347 Stainless Steel					160			
Gold Plate	160				160			
1020 Steel					60			
4130 Steel					60			
303 Stainless Steel	160				160			
304 L Stainless Steel	160				160			
304 L Stainless Steel (Welded)					160			
316 Stainless Steel	160				160			
321 Stainless Steel	160				160			
321 Stainless Steel (Welded)					160			
347 Stainless Steel	160				160			
347 Stainless Steel (Welded)					160			
410 Stainless Steel	160				160			
410 Stainless Steel (Welded)					160			
440C Stainless Steel	160				160			
A-286					60			
PH15-7Mo (Cond. A)	160				160			
17-4PH	160				160			
17-7PH (Cond. A)	160				160			
AM-350 SCT	160				160			
AM-355 (Cond. H)	160				160			
Magnesium, AZ31								150
Magnesium, HM21A-T8								60
Microseal 100-1 on AM100A, Mg				160				160
Microseal 100-1CG on AZ31C, Mg				160				160
Nickel	160				160			
Ni Span C					60			
Nilvar					60			
Nickel Electroplate					60			
Nickel, Electroless Plate	160				160			
Silver Solder					60			
Easy Flo 45						100		
Easy Flo Silver Braze of 347 Stainless Steel					160			
Silver Plate					60			
Tin Plate					60			
Pure Tin Solder of 303 Stainless Steel					160			
Titanium, B120VCA	160				160			
Titanium, A110-AT	160				160			
Titanium, C120AV	160				160			
Titanium Carbide (Nickel Binder)	160				160			
Tungsten Carbide	160				160			
Zinc Plate								60

(continued)

Table 2 (continuation)

Material	Temperature, °F							
	Gas				Liquid			
	Class 1	Class 2	Class 3	Class 4	Class 1	Class 2	Class 3	Class 4
Plastics								
Teflon (TFE)					80	160		
Teflon filled with Graphite					60			
Teflon filled with MoS ₂					60			
Teflon filled with Asbestos					60			
Armalon 7700 with Teflon Fibers							60	
Armalon 7700B with Teflon Fibers							60	
Fluorobestos filled with Asbestos					60			
TFE-Felt 7550						60		
Fluorogreen					60			
Teflon (FEP)					60			160
Kel-F 300 Unplasticized						60		80
Kel-F 300 Annealed							60	
Kel-F 300 (15% Glass Filled)					75			
Kel-F 300 (Unfilled)					75			
Kel-F 800								75
Low-Density Polyethylene					60			
High-Density Polyethylene						60		160
Marlex 50 Polyethylene					60			
Polyethylene 7028						80		
Polyolefin, White Insulation					160			
Polyolefin, Black Insulation							160	
Polypropylene					160	60		
Zytel 31								80
Zytel 63								80
Zytel 101					60			80
Mylar								60
Mylar A						75		
Silicone-Glass Laminate							60	
Phenolic-Glass Laminate								60
Epoxy-Glass Laminate								60
Polyester-Glass Laminate								60
Saran							80	
Delrin								60
Lexan								60
Tedlar						60		
Kynar						80		160
Plexiglas CR 39								60
Plexiglas II								80
Opalon 1219								60
Opalon 1220								60
Opalon 1444								60
Opalon 81222								60

(continued)

Table 2 (continuation)

Material	Temperature, °F							
	Gas				Liquid			
	Class 1	Class 2	Class 3	Class 4	Class 1	Class 2	Class 3	Class 4
Amerplate								160
Tygon								80
Rigid PVC								60
Epon VI								60
Epon 828								60
Epon 103 (with PMDA)								80
EC 1469 Epoxy								60
Hypalon 20								80
Phenolic Asbestos								60
F120-55								60
Silicone R-7001								60
Narmco X3168								60
P-4010					60			
30000					60			
H-Film								160
Dapon 35 (Glass Filled)						75		
Dapon 35 (Unfilled)						75		
Rubbers								
Chicago Rawhide-Sirvene 9623								145
Chicago Rawhide-Sirvene 9694								145
Chicago Rawhide-Sirvene 9617								85
Chicago Rawhide-Sirvene 20316								85
Connecticut Hard Rubber Company 3601								85
Enjay 035					80	75		80
Enjay 218						140		160
Enjay 268								60
Enjay 551							60	
Enjay CR617						85		
Firestone Rubber D-404								85
Firestone Rubber D-430								85
Firestone Rubber D-431								85
Firestone Rubber D-432								85
Firestone Rubber D-406								145
Firestone Rubber D-405								145
Firestone Rubber D-408								145
Firestone Rubber D-409								145
Firestone Rubber D-410								145
Parker Appliance 37-014						85		
Parker Appliance 37-024								
Plastics and Rubber Products 805-70								85
Plastics and Rubber Products 805-90								85

(continued)

Table 2 (continuation)

Material	Temperature, °F							
	Gas				Liquid			
	Class 1	Class 2	Class 3	Class 4	Class 1	Class 2	Class 3	Class 4
Precision Rubber Products 907-90								85
Precision Rubber Products 925-70								85
Stillman SR 613-75						80	160	85
Stoner Rubber BS-55								85
Synthetic Rubber Products 50X8655								85
Synthetic Rubber Products 50223								85
Thiokol C 42986-1						85		145
Thiokol C 55935								85
DuPont Neoprene (1158)								100
B.F. Goodrich Neoprene G91						100		60
Neoprene								60
Hycar 2202							60	85
Hycar 520-41-125-1								85
Hycar 1043 Std. No. 1								85
Hycar 1001								85
Hycar G41								100
Chemigum N6 12								100
Chemigum SL								75
Kel-F 3700								75
Kel-F 5500								75
Fluorubber 1F4								60
Fluorel								60
Viton A								60
Viton A-247M								85
Viton A-44-11 A-35								85
Viton B								60
Stillman Fluororubber								60
EX 821-A70								80
Precision Rubber 18007, 18057								160
Hydropol V						140		160
Hydropol T						145		
Tyzon R3603								75
Saran Rubber								75
Saran Rubber 300 Uncured								100
Saran Rubber 300 Cured								100
Dow Silicone LS-53								100
Dow Silicone DC-152								75
G.E. Nitrile Silicone NSRX5602								85
G.E. Nitrile Silicone SE750								130
Nichols Teflon Modified Silicone LS-53								85
Parco 823-70							80	
Parco 805-70								80

(continued)

Table 2 (continuation)

Material	Temperature, °F							
	Gas				Liquid			
	Class 1	Class 2	Class 3	Class 4	Class 1	Class 2	Class 3	Class 4
Precision Rubber 9357								80
Precision 214-907-9								80
Precision Rubber 9257								80
940 X 559					80			160
Parker B380-7								80
Parker B496-7							60	
Parker 318-70							160	
Goshen 1357							80	
Linear 7806-70								80
Hadbar XB800-71					160			
Formula 120 (Resin Cured)							160	
Formula 121 (Resin Cured)							160	
Acushnet BWK-442							160	
Acushnet SWK-849							160	
Acushnet SWK-850							160	
Acushnet SWK-851						160		
Stillman EX 904-90								160
LS53								60
Hadbar 58789-23GT								80
Thiokol 3000 St.								130
Garlock 900								60
Garlock 22								60
Cohrlastic 500								60
Parco B318-7								60
Adiprene B1158								100
Adiprene B1157								100
Lubricants and Sealants								
UDMH Lube						80		
S No. 58-M						80		
LOX Safe						80		
Andok C						80		
DC-11		80				80		
Microseal 100-1 (Dry Lube)					80			
Rockwell Nordstrom 147						75		
Rockwell Nordstrom 421								75
Rockwell Nordstrom 551								75
Rockwell Nordstrom 921								75
Rockwell Nordstrom 950							80	
Nordcoseal DC-234-S								75
Valve Seal A						80		
Flake Graphite					80			

(continued)

Table 2 (continuation)

Material	Temperature, °F							
	Gas				Liquid			
	Class 1	Class 2	Class 3	Class 4	Class 1	Class 2	Class 3	Class 4
DC-55		80				80		
DC-Hi Vacuum		80				60		
Molykote Z								60
Kel-F 40								75
Kel-F 90						75		60
Kel-F 200								75
Drilube 703								60
Rayco-32								60
Electrofilm 66-C							60	
Polyglycol Oils						80		
FX-45							80	
Apiezon L						80		
XC 150						80		
Fluorolube MG-600							80	
Fluorolube Hg-1200								75
Fluorethane G								80
Anderol L237								75
Carum 200							75	
Fluoropack								75
Lubriseal						75		
Nonaq Stopcock Grease								75
Rectorseal 15								75
Silicone DC 11							75	
Reddy Lube 100					80			
Reddy Lube 200					80			
Water Glass Graphite					80			
Drylube Sealant						80		
Vydax A						80		
Teflon Tape					80			
Potting Compounds								
PR 1422								60
RTV 20								60
Paraplex P-43								60
Proseal 793								60
Fairprene 5159								60
Crystal M&CF								60
Adhesives								
Armstrong A-6								60
EC 847								60
HT 424								60
Epon 422					80			
Epon 4-3								80

(continued)

Table 2 (continuation)

Material	Temperature, °F							
	Gas				Liquid			
	Class 1	Class 2	Class 3	Class 4	Class 1	Class 2	Class 3	Class 4
Ceramics								
Temporell 1500					60			
Sauerelsen P-1					60			
Sauerelsen 31					60			
Sauerelsen 47							75	
Rockflux					75			
Coatings								
Epoxy No. 1								60
Modified Epoxy No. 5								60
Epoxy No. 7								60
Epoxy No. 9								60
Epoxy No. 6809								60
Alkyd No. 4								60
Polyurethane								60
Acrylic Nitrocellulose								60
Vinyl								60
Primer MIL-P-6889								60
Catalac								160
Tygon K								160
Copolymer P-200G								160
CA 9747 Primer								160
Corrosite Clear 581								160
Proseal 333							80	
Markal DA-8								80
Aluminous								80
Graphites								
Graphitar 14								160
Graphitar 39					80			160
Graphitar 84					80			
Graphitar 86					160			
National Carbon CCP-72					160			
Purebon P3N					160			
Purebon P5N						160		
Gasket and Packing Material								
Vistex NS-NES (with Teflon)						75		
Delanium						75		
Neoprene								75
Garlock 900						130		
DuVerre 22								75
Haveg 30								75
Haveg 41								75
Haveg 50								75
Haveg 60						130		
Melbestos G31						100		

Table 3
Compatibility Classifications for Metals (a)

Class	Corrosion Resistance			Shock Sensitivity
	Rating	Penetration Rate, mils/year	Decompn of Propellant	
1	Excellent	<1	No	No
2	Good	<5	No	No
3	Fair	5 to 50	Some	No
4	Poor	>50	Extensive	Yes

(a) The classification of a material is based on the lowest rating of any one of the three properties.

Ignition. 1) A. Corbett et al, "Hypergolic Ignition at Reduced Pressure", AFRPL-64-175, Thiokol, Denville, Contract AF 04 (611)-9946 (1964) (AD-610144) [The investigators, using a proplnt ignition system immersed in a vac tank, examined the ign parameters of N₂O₄-UDMH and N₂O₄-N₂H₄/UDMH (50/50 wt %) proplnts to evolve an ign model. As a major conclusion they state "... ambient pressure alone has the *only* significant effect on ignition characteristics of all the injector and environmental parameters investigated in (these) unconfined impingement tests ...". The effect of ambient press on ign is shown in Fig 2

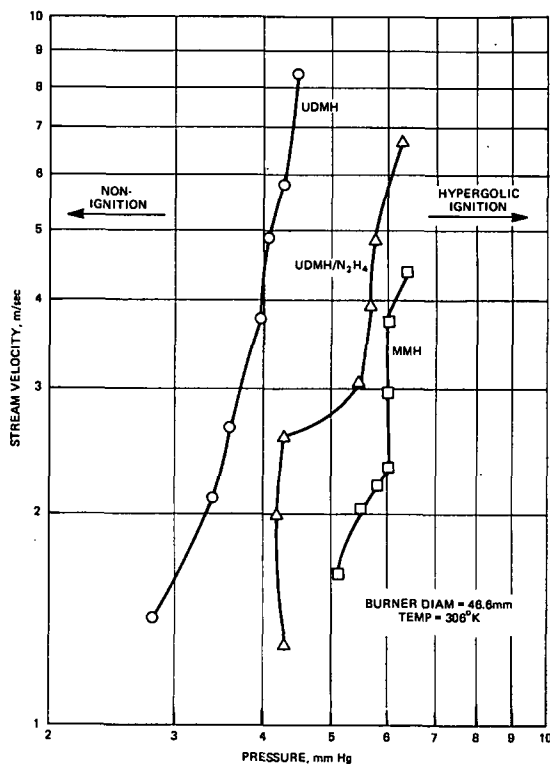

Fig 2 Pressure Limit for Hypergolic Ignition of Hydrazine Based Fuels with N₂O₄

Table 4
Compatibility Classifications for Nonmetals

	Class			
	1	2	3	4
Volume Change, percent	0 to +25	-10 to +25	-10 to +25	<-10 or >+25
Durometer Reading Change	± 3	± 10	± 10	<-10 or >+10
Effect on Propellant	None	Slight change	Moderate Change	Severe
Visual Examination	No change	Slight change	Moderate change	Severely blistered, or cracked, dissolved
General Usage	Satisfactory, general use	Satisfactory for repeated short term use	Satisfactory for short time use	Unsatisfactory

2) S.W. Mayer et al, "Preignition Products from Storable Propellants at Simulated High Altitude Conditions", **SAMSO-68-67**, Aerospace Corp, El Segundo, Contract F 04695-67-C-015 (1967) & **CA 69**, 53310 (1968) [Investigation of the cause of pre-ign destructive detonations in altitude controlled rocket motors using N_2O_2 /UDMH proplnt systems was conducted in lab appar simulating operational high altitude conditions. The study revealed the presence of UDMH- NO_2 , nitromethane, nitramide, monomethylnitramide, nitrosodimethylamine, and nitrosomonomethylamine in the proplnt residue at -11° and sub-atm pressures. The UDMH- NO_2 , a major constituent of the residue, is considered an expl monopropnt by the authors, and as such constitutes the probable cause of the pre-ign deton problem]

3) T. Hubbuch et al, "Thermal Bed for Gas Generation", USP 3664969 (1972) & **CA 77**, 90788 (1972) [The patent claims that continuous ign of UDMH for gas generation is obtd as follows: A thermal ign bed is prepd by vac pumping of (coconut) charcoal in an inert atm, heating the bed to 300° , cooling, and exposing it to NO_2 to obtain 30% loading. The inventors state that UDMH will then ignite on contact continuously even after the NO_2 is consumed]

4) K.A. Bhaskaran et al, "Shock Tube Study of the Effect of Unsymmetrical Dimethyl Hydrazine on the Ignition Characteristics of Hydrogen-Air Mixtures", **Combstn&Flame 21**, 45-48 (1973) & **CA 79**, 94163 (1973) [The authors report that the ign delays of lean, stoichiometric, and rich mixts of hydrogen-air over a temp range of $800-1400^\circ K$ and a pressure of 2.5 atm were exptly detd using a shock tube. Small quantities of UDMH were added to the mixts and their delay periods for the same temps and pressure were detd. Ign was identified by the pressure rise as well as visible light emission using piezoelectric pressure pickups and photomultipliers, respectively. The delay periods of lean, stoichiometric, and rich mixts of hydrogen-air were found to decrease with the addition of small quantities (less than 1%) of UDMH. When the concn of UDMH in the mixt exceeds 3%, it was found that the delay periods tend to be longer than those obtained when no UDMH was present. From their data the authors conclude that the exptl results are attributable to the rapid de-compn of UDMH and its subsequent reaction

with oxygen;

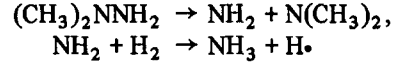

Further, "... The hydrogen atoms formed in the above thermoneutral step adds up to the hydrogen atoms released in the initial stages of H_2-O_2 reaction thereby accelerating the chain explosion. On the other hand, when the concentration of UDMH exceeds a certain limit, it is probable that its decay products inhibit the radical reactions by taking away the available oxygen and hydrogen atoms. This perhaps is the reason for the decreasing influence of UDMH as its concentration in hydrogen-air mixture increases. . ."]

5) T.N. Hubbuch et al, "Hydrazine Monopropellant Process Using a Gas-Generating Bed", USP 3710573 (1973) & **CA 78**, 99986 (1973) [The inventors claim an appar for continuous ign of UDMH operating as follows: When brought into contact with an adsorbate (such as N_2O_4 , Cl or $POCl_3$) adsorbed on a 6-16 mesh carrier (such as activated C, silica gel or activated Al_2O_3) the UDMH reacts and heats the carrier sufficiently to maintain combustion of UDMH admitted after the adsorbate has been consumed]

6) M.A. Saad & S.R. Goldwasser, "Time-Temperature Simulation in Low Pressure Ignition of Hypergolic Liquids", **AIAAJ 12** (1), 11-12 (1974) & **CA 80**, 135473 (1974) [The authors report on a simulated ign study made on N_2O_4 /UDMH proplnt. The means used to perform the study was a computer program developed to simulate the behavior of a droplet of hypergolic liq. The program assumes that a small amount of the droplet reacts forming gaseous products, while simultaneously another small portion of the droplet vaporizes. They found that ignitibility of a proplnt, such as the example N_2O_4 /UDMH system, can be affected drastically by changes in pressure as well as temp; and the geometry of the enclosure surrounding the impinging streams of reactants]

7) M. Ladacki, "Ignition of Hydrazine-Type Monopropellants", USP 4161104 (1979) & **CA 91**, 177524 (1979) [UDMH can be ignited by the addition of Ag nitrate to Cu chromite in intimate contact with the UDMH]

Pollution: 1) W.T. Gormley & R.E. Ford, "Deoxygenation of Environmental Waters. 1. Hydrazine-Type Fuels", **ProcAnnualConfEnvironToxicol**, 4th, 1973 (1973) (AD-781031)

& CA 82, 150109 (1975) [The effects of UDMH pollution of environmental waters are reported as a change of pH and deoxygenation of the water because of the degradation of the fuel. These effects were studied by means of mathematical models using UDMH degradation rate equations involving water temp, ionization constant and buffer characteristics] 2) M.G. MacNaughton & T.B. Stauffer, "Treatment of N-nitrosodimethylamine (NDMA) Contaminated Waste with Activated Carbon", AFCEC-76-32 (1976) (AD-A039229/OST) [The investigators report that although all of the commercially available activated carbon brands tested are capable of reducing NDMA concn in the waste solns generated during UDMH manuf by more than 99%, the position of the US Environmental Protective Agency (EPA) in restricting disposal of any liq waste in the USA which contains NDMA (a known carcinogen) at *any* concn, precludes using this technique. However, they suggest that the liq contg residual NDMA after activated carbon absorption could be disposed of by deep well injection (with approval of the site and procedure by the EPA). The EPA also suggested that the soln-wet contaminated carbon could be incinerated if a sufficiently corrosion-resistant incinerator were available, since the liq waste also contains large amounts of Na hydroxide] 3) P.A. Lurker, "Catalytic Deoxygenation of Aqueous Solution by Hydrazine", USNTIS-AD-A025794 (1976) & CA 85, 179822 (1976) [Kinetic studies of UDMH degradation in water at 25° and 37° were conducted to determine the thermal effect on the rate of degradation with only Cu present in the water-fuel mixt. An equation was derived from this and prior data to predict effects at various temps] 4) S. Banerjee et al, "Environmental Degradation of 1,1-Dimethyl-Hydrazine", CEEDO-78-14 (Paper No 11), 113-28 (1978) & CA 90, 115966 (1978) [The objective of the author's program was to find the rate of degradation of UDMH in natural lake water so as to predict its persistence in aquatic environments. The information derived from the study includes the rate of oxidation of UDMH with Cu⁺⁺ concn, and the fact that the combination of the pH of the lake water plus dissolved oxygen causes the degradation of UDMH-HCl in the absence of microbes to form an unidentified product with absorption

at 326 nanometers. Further, the authors report that this product is degraded by microorganisms to the extent of its disappearance in nonsterile water] 5) G.L. Loper, "Gas Phase Kinetic Study - Air Oxidation of UDMH", CEEDO-78-14 (Paper No 13), 129-57 (1978) & CA 90, 128176 (1979) [The author suggests that upon exposure to air, UDMH may be converted to trace amounts of the potentially carcinogenic compd, N-nitrosodimethylamine (NDMA). Hence, the kinetics of UDMH air degradation was studied to find an index to the potentially hazardous pollution resulting from a fuel leak into air]

Properties: 1) D.L. Armstrong, "Liquid Propellants for Rockets", in S.S. Penner & J. Ducarme, Eds, "The Chemistry of Propellants", Pergamon Press, NY (1960), 121-68 [Presented are some previously unlisted properties of UDMH: Critical temp, 249°; Density, g/ml at 15.6°, 0.790; Heat capacity at const press, cal/g/°C at 25°, 0.654; Heat of vapn, cal/g at 63°, 133.9; and vapor pressure, mm Hg at 26.7°, 160] 2) Anon, "Study of Forces on Propellants due to Heat Transfer Influencing Propellant Temperature in a Recovery Type Vehicle", Dynamic Sci Corp, South Pasadena (1962) [The following calcd properties are reported for gaseous UDMH: Thermal conductivity at 323°K, cal/cm-sec-deg K, 162×10^{-7} ; Specific heat, cal/g-deg K, 0.165; and viscosity at 323°K, g/cm-sec, 7.86×10^{-5}] 3) H.R. Bader, Jr et al, "Rocket Engines - Liquid Propellant. Volume I-Small Engines", DO-114118-2-Vol 1, Boeing, Seattle (1968) (AD 843667) [The density, specific heat, vapor pressure and viscosity of UDMH and Aerozine-50 (UDMH/hydrazine, 50/50 wt %) over a temp range of -60° to +140°F are presented in Figs 3 & 4

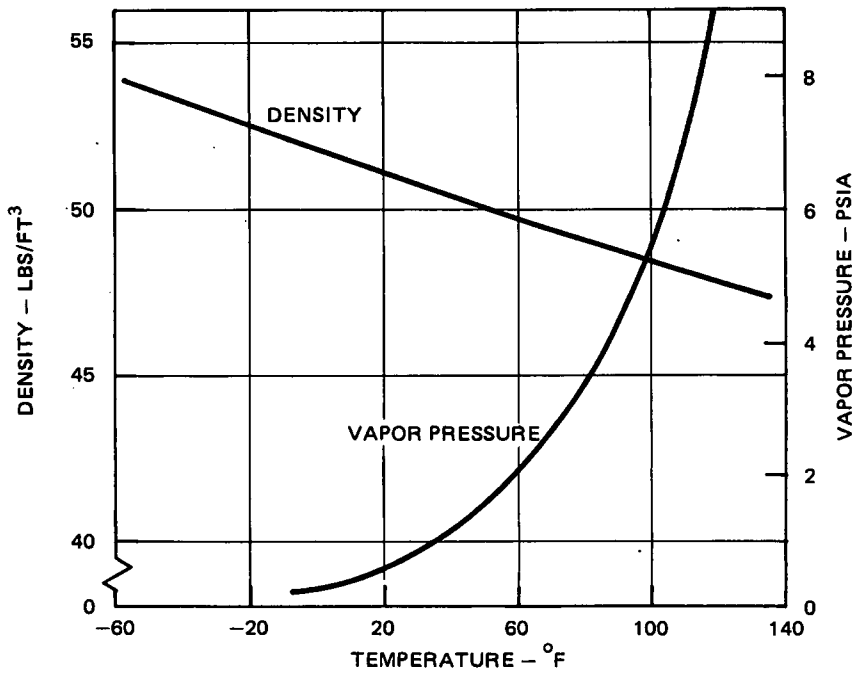
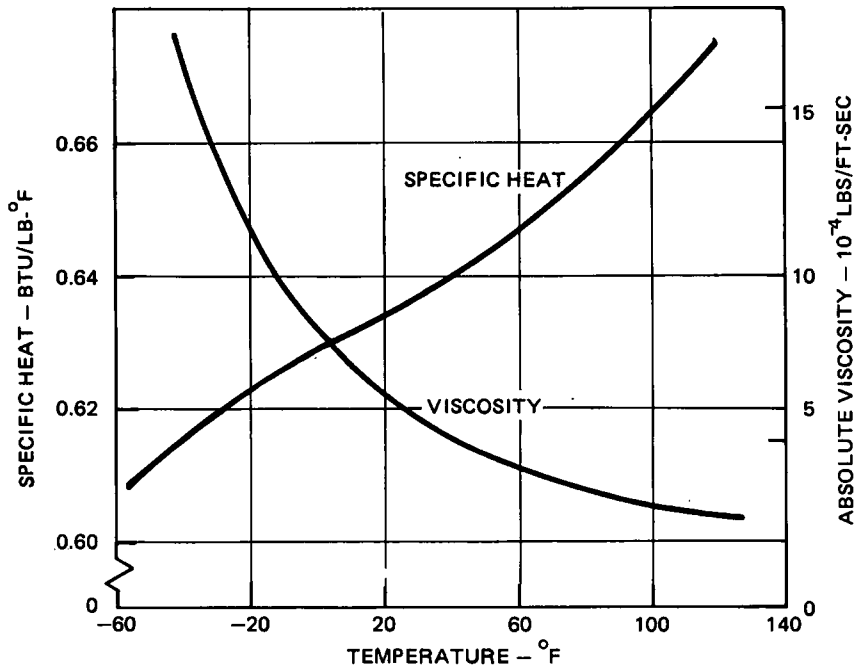

Fig 3 Physical Properties of UDMH

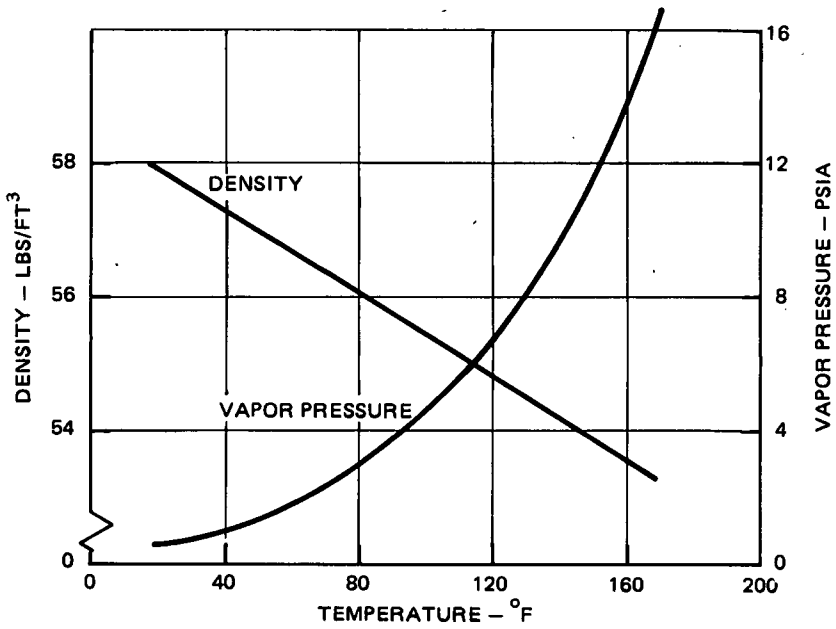
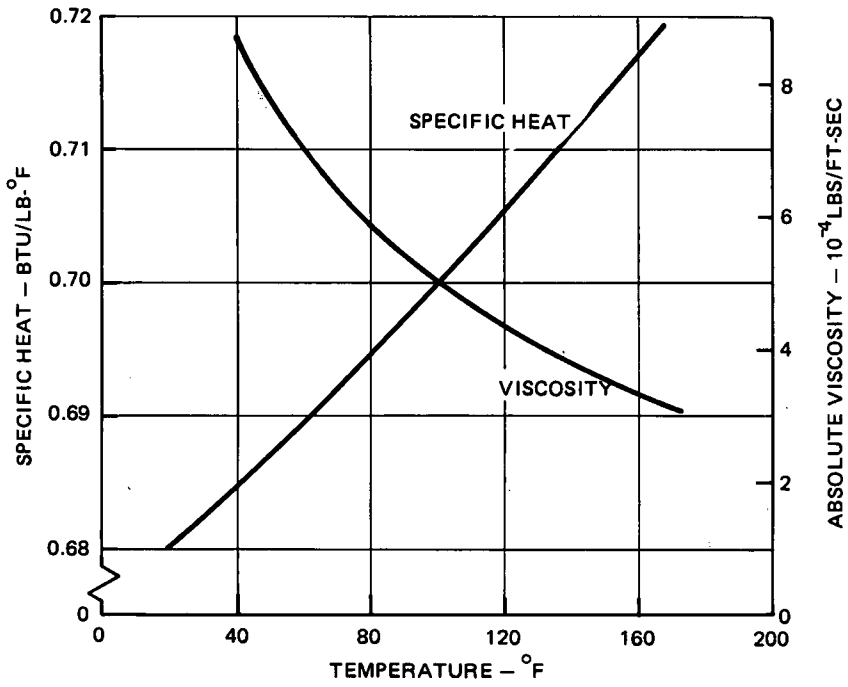

Fig 4 Physical Properties of Aerozine-50]

Sensitivity: 1) J.A. Simmons et al, "Reactions and Expansion of Hypergolic Propellants in a Vacuum", *AIAAJ* **6** (5), 887-93 (1968) & *CA* **69**, 4076 (1968) [Equal vols of Aerozine-50 (UDMH/hydrazine - 50/50 wt %) and N_2O_4 , upon simultaneous release into varying vacuum environments exhibited the following reactions:

Pressure	Reaction
≥ 0.1 atm	normal hypergolic combustion
≤ 0.01 atm	no reaction; red-orange material formed
< 1 torr	red-orange mist forms
3 to 4 torr	red-orange mist detonates - apparently initiated by contact with the warm surface of the steam-ejector pumping system

Originally in spherical glass bulbs which were broken within the vac system, the liquids were dispersed, according to the investigators, by boiling at their exposed surfaces. The resulting clouds of vapor drops are described as expanded symmetrically in a manner similar to that of a gas alone] 2) T.F. Seamans & P.C. Waser, "Effects of Additives on Ignition Delay and Chamber Pressurization of Space-Ambient Engines", *AFRPL-68-194* (1968) (AD-843877) [Investigation of the sensy of various mixts of nitrogen tetroxide (NTO), nitrogen monoxide (NO) and UDMH/hydrazine-50/50 wt% (50-50) resulted in the data listed in Table 5

3) H.K. James et al, "Physical and Explosion Characteristics of Hydrazine Nitrate", *USBu-MinesInfoCirc* **8452** (1970) & *CA* **73**, 100621 (1970) [The authors report that no *expl* reaction occurs when a soln of Aerozine-50 (UDMH/hydrazine-50/50 wt %) and α -hydrazine nitrate is mixed with N_2O_4 , "... although much reaction was evident ..."] 4) V.Y. Oka & P.K. Dutta, "Some Observations on Hypergolic Reactions of UDMH and Furfuryl Alcohol with Fuming Nitric Acids", *JArmamentStudies* **14** (1), 62-65 (1978) & *CA* **90**, 8520 (1978) [Reported is the relative ign delay on mixing UDMH with either red fuming, white fuming or 90% nitric acid. The ign delay decreased in the order 90% nitric acid \approx WFNA to RFNA shortest]

Toxicity: 1) M. Sittig, "Hazardous and Toxic Effects of Industrial Chemicals", Noyes Data Corp, Park Ridge (1979), 246-51 [Current recom-

Table 5
Trauzl Block and Drop Weight Test Values for the Liquid Reaction Intermediates

Sample	Trauzl Block Expansion* cc/cc of Sample	Drop Weight 50% Height** Inches
T (NTO/50-50, Oxidized/Fuel = 2.5)	$\geq 40, \geq 40$	
M (NTO + NO/50-50, Oxidized/Fuel = 2.5)	$\geq 40, \geq 40$	1-2
P (NTO + NO/50-50 + H_2O , Oxidized/Fuel = 2.5)	$\geq 40, \geq 40$	
J (NTO + CH_3CN /50-50, Oxidized/Fuel = 2.5)	$\geq 40, \geq 40$	

Footnotes to Table 5:

*Corrected for volume increase due to blasting cap alone

**2 kgr weight (PicArs type appar)]

mended ceiling concns in any 2-hr period for UDMH exposure is 0.15mg/cm (0.06ppm). An older standard is reported as 0.5ppm. Harmful effects reported are: *Local*-Vapor is highly irritating to the eyes, upper respiratory tract and skin and causes delayed eye irritation. Liq is corrosive, producing penetrating burns and severe dermatitis. *Systemic*-Carcinogenic in mice after oral administration. May produce liver necrosis, methemoglobinemia, hemolysis, fatty liver, mutagenesis, inhibits monoamine oxidase and may form potent biological metabolites] 2) R.C. Shank, "Comparative Metabolism of Propellant Hydrazines", *AMRL* **79-57**, Univ Calif, Irvine, Contract F 33615-76-C-5005 (1979) [The study revealed that the LD_{50} for mice is 190mg/kg body wt, ingestion of UDMH does not result in DNA methylation in lab animals, and UDMH is metabolically oxidized to CO_2 at different rates by various tissues from rats, mice and hamsters]

Uses: 1) Urbanski **3** (1967), 309 [As a hypergolic rocket proplnt fuel upon mixing with nitric acid or liq oxygen for USA rocket vehicles such as Nike Ajax, Rascal and Vanguard 1] 2) D.B. Boies & L.G. Forgala, "Storable Propellant Fuel Cells", *ElectrochemTechny* **5** (7-8), 331-35 (1967) & *CA* **67**, 7835 (1967)

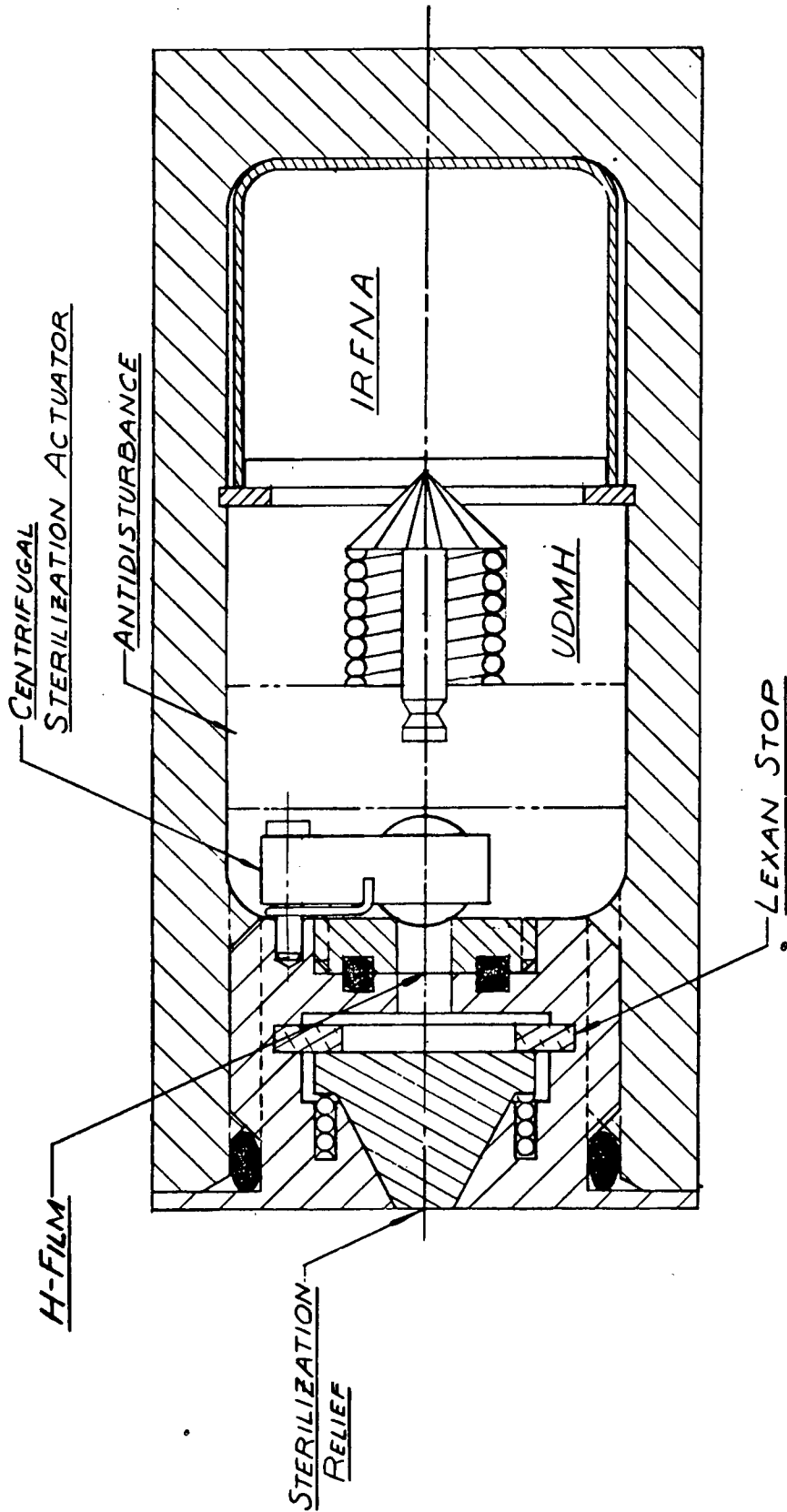

Fig 5 H-Film Silent Sterilization Mine Concept]

[A fuel cell utilizing UDMH as fuel and NO_2 as oxidant is reported. Operated intermittently over a 3-month period with degradation, it consistently produced a power density of $40\text{mw}/\text{cm}^2$ ($40\text{w}/\text{ft}^2$). The cell consists of a sandwich of Zr acid phosphate in a polyvinylidene fluoride (PVF) binder and diffuse-catalyst layers of Pt black, Zr acid phosphate and PVF. Pt screens are used as current collectors]

3) G.R. Eskelund et al, "Chemical-Mechanical Mine", PATR **3724** (1968) [A mine feasibility study is reported in which the hypergolic system UDMH-nitric acid is used as the fragmenting "expl", with activating contact obtd by means of an intruder operated cutter which then allows the reactants to mix. Mine sterilization is obtd by the leaking of the UDMH from the mine thru a poly-[N,N'-(p,p'-oxydiphenylamine pyromellitinide)] film ("A-film"). The authors conclude from their study that the system is feasible, but that it requires more refinement in the areas of its wt and time-lapse sterilization effect. A version of the mine is shown as Fig 5]

4) C. Boyars & K. Klager, "Propellants Manufacture, Hazards and Testing", Advances in Chem **88**, ACS, Washington (1969), 369 (S.S. Penner, "Combustion of Liquid Propellants and the Use of Similarity Principles in Theoretical Combustion Research") [The author suggests the use of UDMH/hydrazine-50/50 wt %, to control heat transfer across the injector face of a liq proplnt rocket engine by acting as a film of coolant on the periphery of the injector plates. Thus, the combustion rate, and therefore the thrust, of the engine are controlled]

5) B.R. Simoneit et al, "Apollo Lunar Engine Exhaust Products", Science **166** (3906), 733-38 (1969) & CA **71**, 126682 (1969) [The authors state that the Apollo lunar descent engine uses as its proplnt a 1:1 mixt of UDMH and N_2O_4]

6) W.W. Wharton & J.W. Connaughton, "Using Storable Propellant Fuels in Supersonic Combustion Ramjets", USP 3811280 (1974) & CA **81**, 79922 (1974) [A method is suggested for the decompn of UDMH into a H-contg gas which is then oxidized into a supersonic combstn mode by injection into a supersonic airstream. The crucial portion of the procedure consists of mixing enough oxidizer with the fuel to vaporize and crack the fuel into the H-rich gas, eg, RFNA and UDMH in a wt ratio of 0.09]

7) N.J.

Sippel, "Hydrazine Gel Composition", USP 3821043 (1974) & CA **82**, 46007 (1975) [The inventor claims a high energy gelled rocket proplnt, stable at -65° to $+165^\circ\text{F}$, which consists of UDMH < 20 , a gelling polymer (Kelgan) < 5 , and Al $< 80\%$. The gel is made by acidifying a small portion of the fuel, adding the polymer to the fuel to form the gel, and then adding the remainder of the fuel]

8) R. Meyer, "Explosives", Verlag Chemie, NY (1977), 79 [Use is reported as a monergol by catalytic decompn. Also reported is a precision pulse effect obtd using UDMH as a USA space rocketry technique]

9) T.J. Galvin, "Hydroxyethyl Cellulose-Thickened Hydrazine and Substituted Hydrazines", USP 4002515 (1977) & CA **86**, 123920 (1977) [The inventor suggests incorporation of 0.2 to 10 wt % of hydroxyethylcellulose as a thickening agent for UDMH when used as a proplnt fuel together with 0.2 to 10 wt % of an oxidizer]

10) G.C. Pant et al, "Theoretical Performance of Some New Rocket Fuels Containing Natural Products with RFNA as Oxidizer", JArmamentStudies **14** (1), 47-51 (1978) & CA **90**, 8519 (1978) [Reported as a computer calcd optimum proplnt fuel mixt using RFNA as the oxidizer is turpentine-kerosene-UDMH in the proportions of 40:40:20, yielding a specific impulse of 226.9sec]

11) H.H. Sisler & M.A. Mathur, "Synthesis of Hydrazine and Its Derivatives", CEEDO-78-14 (1978), 1 [See below]

12) W.F. Watje, "Potential of a Hydrazine-Type Fuel Spill or Emission During Movement from Supplier to User", Ibid, 19-21 [According to Ref 11, UDMH is a component of several currently used (circa 1978) liq rocket fuel mixts. These include Aerozine-50 (UDMH/hydrazine-50/50 wt %), MAF-1 (39 wt % UDMH), MAF-3 (20 wt % UDMH) and MAF-4 (60 wt % UDMH). This usage as reported by Ref 12, has resulted in an avg annual (again, circa 1978) UDMH shipment of 1.4×10^6 lbs and a UDMH/hydrazine shipment of 2×10^6 lbs]

13) J.J. Bost et al, "Gelled Mechanically Stable High Energy Fuel Composition Containing Metal Platelets", USP 4187129 (1980) & CA **92**, 165899 (1980) [Claimed are mechanically stable high energy UDMH contg proplnt fuels which do not flow under their own wt and show thixotropic properties under shear rates produced by rapidly

shaking the fuel in a container. Reported prepn is by mixing Al platelets (of avg one micron diameter with a maximum diameter of less than 44 microns) 30p and UDMH 70p together to form the gel]

Ugol'nyiye Ammonitye. Russian permissible expls for blasting coal in dusty and/or fiery mines. See under "Coal Mining Explosives, Permissible" in Vol 3, C454-L & R

Ulmate of Ammonium (Ulmate d'Ammoniaque in Fr). See under "Ammonium Ulmate or Ammonium Humate" in Vol 1, A381-R to A382-L

"Ultimate" Fuels for Jets and Rockets. See under "Exotic Fuels" and "Exotic Propellants" in Vol 6, E350-L

Ultrafine Ammonium Nitrate (UFAN). See in Vol 1, A311-L to A340-R under "Ammonium Nitrate", and the following *Addnl Refs*: 1) E.E. Hackman III, "Combustion Characteristics of Crystalline Oxidizers", **AFOSR-67-2027**, PhD thesis, Univ of Delaware (1967), 94-95 (AD-819626/3ST) [Differences between amm nitrate (AN) and amm perchlorate (AP) oxidizers can be readily detected since UFAN burned half as fast as an equivalent size AP at the same pressure. These powder burning rates ranked in the same order as single crystal or high density powder burning rates. Since the characteristic burning surfaces for AP and AN are nearly the same when the oxidizers are burned as physically similar powders, the minimum flame zone thickness is the same for both] 2) R.A. Dick, "The Impact of Blasting Agents and Slurries on Explosive Technology", **IC 8560**, USBuMines (1972) [The shock sensitivity of ANFO (AN-fuel oil) compns increases rapidly as the AN particle size decreases. However, by compression to a density of approx 0.9g/cc, sensitivity is found to decrease and deton vel to increase]

Ultrafine Ammonium Perchlorate (UFAP). See in Vol 8, P147-L & R under "Ammonium Perchlorate", and on P430-R, P433-R (Table 29), P435-R, and P437-R (Table 36) under "Propellants, Solid", plus the following *Addnl Refs*:

Proplnt Burning Rate Stability: R.D. Gould, "Combustion Instability of Solid Propellants, Effect of Oxidizer Particle Size . . . Plastic Propellants", **RPE-TR-681**, Westcott (Engl) (1968) (AD 684244) [Investigation of the effect of amm perchlorate (AP) particle size on the burning rate stability of proplnt comprised of AP (88) and 90% polyisobutylene (12 wt %) led the author to the conclusion that the finer the AP particle size, the more stable the combustion]

Proplnt Combustion: E.E. Hackman III, "Combustion Characteristics of Crystalline Propellant Oxidizers", **AFOSR-67-2027**, PhD Thesis, Univ of Delaware (1967)(AD 819626/3ST) [One of the conclusions drawn from this study is that, ". . . low bulk density ammonium perchlorate (UFAP) powders burn stably over a wide pressure range (1 to 100 atms) when insulated and partially fuel assisted . . ."]

Ignition: R. Ramaprobhu & K.A. Bhaskaru, "Effect of Particle Size of the Oxidizer on the Ignition Delay of Composite Solid-Propellants", **ProcNatlConfEngCombustn**, 5th, Paper **C2-4** (1978) & **CA 90**, 189311 (1979) [The major conclusion reached is that the smaller the AP particle size, the shorter the ignition delay time. The authors state that this effect is due to the degree of obstruction across the proplnt cross-section which is directly subjected to the energy stimulus used prior to ignition. Further, this effect of AP particle size is more predominant at higher than at lower pressures, yielding a higher regression rate for UFAP]

Preparation: 1) E.R. Rogers et al, "Coated Ultrafine Ammonium Perchlorate Particles", **USP 3954526** (1976) & **CA 85**, 96630 (1976) [Claimed is the prepn of AP particles of sub-micron size for proplnts by soln in a mixt of two volatile liquids, the second being less volatile than the first, and a non-AP solvent. The first liq is evapd to form an AP suspension in the second. The AP is subsequently coated with surfactants or polymers which are partially soluble in the second solvent, and this solvent is evapd to yield a powder or slurry. The average coated AP particle is 0.52 to 0.99 microns in

diameter] 2) O.E. Ayers et al, "Small Particle Size Coated Ammonium Perchlorate", USP 3953257 (1976) & CA 86, 45344 (1977) [The inventors suggest a technique for yielding a non-agglomerating UFAP which can be mixed with proplnt binders to give increased pot-life. Thus, dry 200-micron diameter AP (8 lbs), Freon 113 (30 lbs), and N-phenethylazuridine (3.63g) are milled for 2 hrs, the slurry subsequently discharged and dried for three days at 140°F. The resultant coated AP particles are 2.5 to 3 microns in diameter with surface areas of from 1.3 to 1.5m²/g]

Ultramicroanalysis. See under "Microanalysis of Explosives" in Vol 8, M123-L & R; "Mass Spectrometry: Analytical Applications" in Vol 8, M37-L; "Color Reactions and Color Reagents" in Vol 3, C405-L to C420-L; "Radioactive Tracers: Use in Energetic Materials", "Spectroscopy of Energetic Materials", and "Taggants for Explosives" in Vol 9, pps R104-L ff, S178-L ff, and T3-L ff, respectively

Ultrasonics in Ordnance

Introduction

Ultrasonic technology deals with problems of measurement, testing, control and processing by the use of sonic energy. The frequency range spans the entire spectrum from the audible to the hypersonic (10² to 10¹²Hz). Ultrasonics in ordnance and proplnt technology has found application in nondestructive testing of large or complex shapes, in the examination of cracking and similar failure modes, in control and initiation devices as well as in certain process technologies

These applications of ultrasonics constitute only a small portion of the total scope of sonic technology which is presented in specialized references (Refs 9 & 11). Strictly speaking, the ultrasonic range should begin above 16kHz, the limit of human auditory capacity, but as the limits of only a few applications have been extensively explored, the range of ultrasonics of interest here must be chosen somewhat wider. Moreover, the choice of the human auditory

capacity for range demarkation is misleading in that it is difficult to transmit high frequency sonic energy from air into a medium of higher density, and that therefore the principle applications require the coupling of a high frequency source to a mechanical detector by some coupling medium of appropriate acoustic impedance match

Fundamental Principles

Sonic signals are generated in a medium by a transducer which converts electrical energy to mechanical (acoustic) energy and vice versa. The energy may be either pulsed or continuous. When a transducer generates energy for a short time (on the order of microseconds) and then pauses before repeating, pulsed acoustic signals are generated. When energy is generated without pause, continuous acoustic signals are produced. Both types find application in ultrasonic materials testing

Ultrasonic waves are a mechanical disturbance which passes thru the medium by the progressive displacement of particles. The particles do not travel in the direction of the source but vibrate about their mean fixed position. The amplitude of the wave is the distance from peak to peak and therefore is the maximum displacement of a particle in the medium. The period (T) is the time required to complete one cycle and the frequency (f) refers to the number of cycles per unit time. The unit of frequency is the Hertz (Hz, one cycle per second) and it is the reciprocal of the period. The rate at which sound travels thru the medium is the velocity (c, meters per second). The wavelength (λ, meters), is the distance between adjacent cycles. Therefore, the relation between wavelength, velocity and frequency is given by

$$\lambda = \frac{c}{f}$$

The resonance characteristic of the transducer is given by the measure Q:

$$Q = \frac{f_r}{f_2 - f_1} = \frac{f_r}{BW}$$

where: f_r = the resonance frequency
 f_1, f_2 = frequencies above and below that at which the velocity amplitude is reduced to one-half of its maximum value
 BW = the bandwidth of the transducer, $f_2 - f_1$

The bandwidth is the range of frequencies over which a sonic transducer will vibrate

A transducer with a high Q has a high sensitivity at f_r , but a low band width, a quality useful in resonance measurements. A high Q transducer acts as a filter for frequencies other than those near the resonant frequency. For this reason, the electrical output signal of a high Q transducer is not an accurate representation of a broadband ultrasonic source. The limit of the transducer resolving power is the time required for it to stop vibrating or "ringing" after excitation. Ringing may mask echoes from the points of interest within the material to be tested. For this reason, the transducer Q should be as low as possible for pulsed measurements

Sensitivity is the ability of an ultrasonic test system to detect the presence of small defects. One of the factors affecting sensitivity is the wavelength of the signal in that the shorter the wavelength the higher the sensitivity

The attenuation of sonic energy by absorption is an exponential function of the pathlength, x, and the absorbance, a:

$$\frac{I_x}{I_0} = e^{-2ax}$$

Other mechanisms which contribute to attenuation are beam spreading, couplant mismatch, scattering and material geometry. Absorption depends on the elasticity of the material. Matter with a low modulus of elasticity tends to absorb more energy, resulting in the conversion of mechanical energy into heat. Scattering is caused by the partial refraction at each of many points of discontinuity within the material. With fine grain structures such losses need not be large. Where the particles are segregated as one would find for instance in a dewetted proplnt, much energy may be scattered. This phenomenon has recently been made the subject of a study of incipient damage thresholds of uniaxially stressed solid rocket proplnts (Ref 17)

The spreading or divergence of a beam of ultrasonic energy is given by:

$$\sin \alpha = \frac{1.2\lambda}{D}$$

where: α = the half angle of the spread

λ = the wavelength

D = the diameter of the transducer

The factor which determines the energy transfer from one medium to the other is the acoustic

impedance:

$$Z = \rho c \frac{\text{kg}}{\text{m}^2 \text{ sec}}$$

For the convenience of the reader, the values of the sonic characteristics of representative and frequently encountered materials are listed in Table 1. Energy which is not transferred is reflected. Maximum transfer takes place when the acoustic impedance of all materials are equal

When the angle of incidence is normal to the interface, the fraction of the reflected incident energy is found as follows:

$$\frac{W_r}{W_0} = \frac{(Z_1 - Z_2)^2}{(Z_1 + Z_2)^2}$$

where: Z_1 = acoustic impedance of medium 1

Z_2 = acoustic impedance of medium 2

W_0 = incident energy

W_r = reflected energy

If a sound wave obliquely encounters an interface between two materials of unequal sonic properties it is refracted or bent. The angle of refraction can be calcd by Snell's Law:

$$\frac{\sin \alpha}{\sin \beta} = \frac{C_1}{C_2}$$

where: α = angle of incidence

β = angle of refraction

C_1 = sonic velocity in the first medium

C_2 = sonic velocity in the second medium

Unlike light, a sound wave of one type, eg, longitudinal, will not only be refracted longitudinally in the second medium but it will be transformed partially or completely into waves of another type, such as shear, surface or plate waves. Since these waves have different velocities in the same medium, they will refract at different angles. Thus it is possible to create waves of several modes in the same material at the same time

Application of Ultrasonics to Propellant Technology

Because ultrasonic waves, as distinct from sonic waves, possess great penetrating power and do not tend to be easily scattered, they can be focused on and reflected from any defects in a material. Therefore, ultrasonics has found application in locating cracks, cavities and flaws, particularly in proplnts, but also in cannon

The Brush Development Company (Ref 16) has manufd a device suitable for testing large grains of proplnts intended for rockets. It has been claimed that this method is just as reliable as flash radiography and also somewhat less expensive

Table 1
Acoustic Properties of Selected Materials (from Ref 9)

Material	Bulk Sonic Velocities $\times 10^3$ m/sec	Density $\text{kg/m}^3 \times 10^3$ (*) $\times 10^0$	Acoustic Impedance $\times 10^6 \text{ kg/m}^2\text{-sec}$ (**) $\times 10^3 \text{ kg/m}^2\text{-sec}$
Aluminum 17ST	6.35	2.80	17.5
Beryllium	12.80	1.82	23.3
Bismuth	2.18	9.80	21.4
Brass 70-30	4.37	8.50	37.0
Bronze	3.53	8.86	31.2
Cadmium	2.78	8.60	24.0
Constantan	5.24	8.80	46.0
Copper	4.06	8.90	41.8
Gold	3.24	19.30	62.6
Hastelloy X	5.79	8.23	47.7
Iron	5.96	7.90	46.8
Lead	2.16	11.40	24.6
Magnesium	5.74	1.70	9.9
Manganin	4.66	8.40	39.0
Molybdenum	6.29	10.09	63.5
Nickel	5.63	8.80	49.5
Inconel, wrought	7.82	8.25	64.5
Platinum	3.96	21.40	84.6
Silver	3.70	10.50	39.0
Steel	6.10	7.70	47.0
Steel, SS410	7.39	7.67	56.7
Tin	3.32	7.30	24.2
Titanium	5.99	4.50	27.0
Tungsten	5.18	19.25	99.8
Uranium	3.37	18.70	63.0
Zinc	4.17	7.10	29.6
Zirconium	4.65	6.40	29.8
Glass	5.77	2.51	14.5
Quartz	5.57	2.60	14.5
Ice	3.98	0.90	3.6
Ethanol	1.17	0.79	9.2
Mercury	1.45	13.54	19.7
Transf Oil	1.38	0.92	12.7
Water	1.483	0.998	14.8
Air	0.331	1.29 (*)	0.428 (**)
Helium	0.997	0.174 (*)	0.173 (**)
Hydrogen	1.265	0.09 (*)	0.115 (**)
Oxygen	0.327	1.38 (*)	0.451 (**)

An acoustic emission system was designed for use in a strand burning bomb (Refs 10 & 15). The signal, presumably created by the thermal fracture or deflagration of the solid oxidizer, reveals anomalies such as side burning, voids and sudden changes in burn rate

A new ultrasonic technique for studying dewetting and cumulative internal damage in solid propellants has been reported (Refs 17 & 20). This technique yields volume-dilatation data on propellant in tension, and on damage in uniaxial compression and shear strain fields. Estimates of vacuole size and number density arising from dewetting can be made, as well as can the time dependent void growth at constant strain be observed

The effect of aging and of process variables on the rheological properties of solid propellants has been the subject of mechanical shear relaxation spectroscopy (Ref 4). The technique is of interest to such filled polymer systems generally in that anisotropy in the viscoelastic properties can be readily observed

Application of Ultrasonics to Crack Diagnostics

Ultrasonic techniques lend themselves to automated mapping of fatigue cracking as has been done for 105mm cannon (Refs 12, 18 & 19). The device was developed at Watervliet Arsenal and can detect the length, depth and location of cracks, and records the data. An operator moves an ultrasonic probe over the outside surface of the barrel. Digital circuits determine when the probe is directly over a crack, measure the local thickness of the wall and compare it with the design value. The comparison indicates the depth of the crack on the inner wall accurate to within $\pm 0.076\text{cm}$ (Ref 19)

Resonance Tubes

In 1916, Hartmann discovered (Ref 7) that intense noise is generated from shallow cylindrical cavities when these are impinged by sonic gas jets, owing to resonant oscillations. Later it was shown that a very slender Hartmann whistle, with a length to diameter ratio of 30, exhibits intense heating at the closed end. Since that time, further improvements have taken place, principally in the incorporation of tapered or stepped cavities (Ref 7) culminating in the fluoric match (see Fig 1)

The gasdynamics of resonance tubes have been analyzed by Sinha (Ref 8). Typical exptly

detd endwall temp-time curves have been reproduced in Fig 2 from Ref 14. Recently, military systems requirements have seen implementation of the resonance tube into practical devices capable of converting flow energy into sufficient thermal energy to cause pyrotechnic and ordnance initiation. As shown in Fig 2, the comparatively long ignition delay, and hence, imprecise initiation times, appear the chief disadvantage. The potential immunity of such fluidic systems from external effects of hostile environments has been a great impetus to their development. These and other applications depend critically on the size and spacing of the sonic throat and the resonance cavity. Its use was investigated for mortar repositioning (Ref 13), and test firings of a prototype system on a 60mm mortar demonstrated repositioning accuracy of $38\mu\text{m}$ in azimuth and $\pm 110\mu\text{m}$ in elevation

Ultrasonic fluidic systems have been used to generate an electrical signal. This is a new fuzing principle which embodies new safing and arming signatures. These innovations promise improved safety and reliability for systems with no spin and small set-back forces, such as mortar shells and rockets. The generator obtains its driving energy from ram air thru an opening in the nose of the projectile. The air, after passing thru a Hartmann whistle, generates acoustic energy in a resonating cavity which in turn drives a metal diaphragm at resonance frequencies. The output of the diaphragm generates an emf in a coil. There is a linear relationship between output voltage and velocity which can be integrated to yield the distance traveled, eliminating thereby complex timing systems. Fluoric firing circuits remain inactive unless the projectile or the aircraft are in motion

The Picatinny Arsenal Fluidic program began in the early 1960's, resulting in the development of the Fluoric Explosive Initiator (FEI), also known as the fluoric match. This is in effect a Hartmann whistle whose tapered or stepped cavity adjoins a pyrotechnic initiator which in turn is connected to an expl cutter valve. In this application fluidic power sources are in effect one-shot devices for safe and arming systems (see also under "Fluidics for Ordnance" in Vol 6, F112-R to F118-L)

The problem of attaining sufficiently brief initiation times with fluidic initiators was ex-

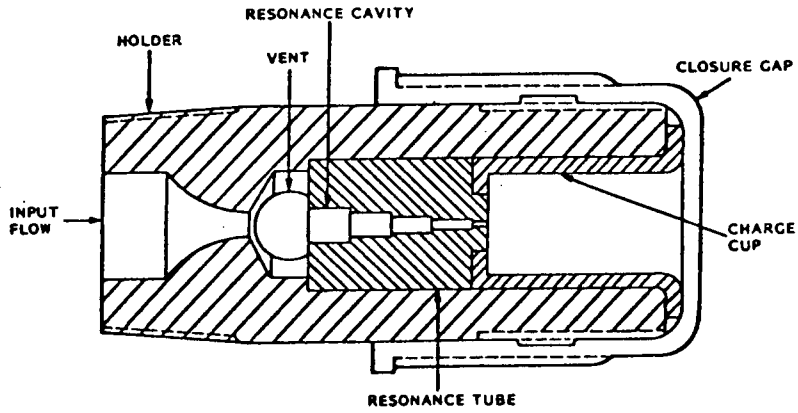

Fig 1 Schematic Drawing of Fluoric Match
(from Ref 14)

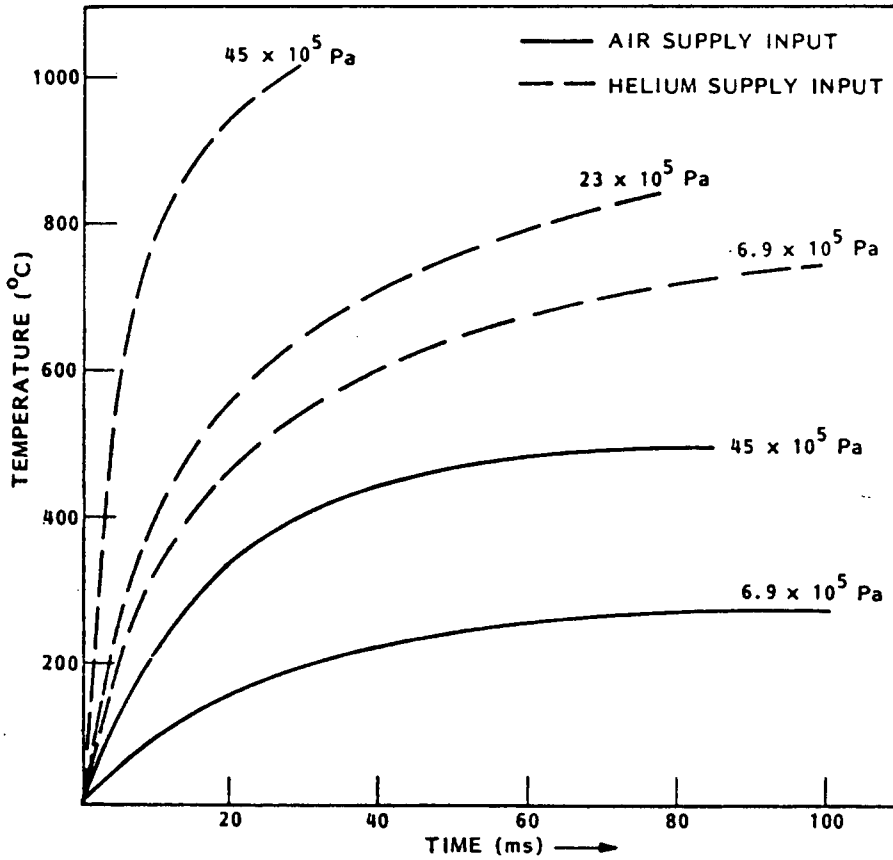

Fig 2 Dependence of Temperature Rise in Fluoric Matches on Gas Pressure (from Ref 14)

amed by Morris and Marchese (Ref 14). This study was directed toward cartridges such as are found in aircrew escape systems. The resulting data on the dependence of resonant cavity temps, and the functioning times on gas pressure and gas composition are illustrated in Fig 2. It appears as if high heat capacity of the gas is the principle factor in reducing initiation delay. This means that hydrogen and helium are the best candidates. Moreover, it appears that proper functioning is also dependent on a clean and filtered gas supply

Hartmann whistles have also found application in process technology by utilization of the sonic energy for the dispersal of liquids. So-called "Liquid whistles" serve to produce emulsions and dispersions. A high pressure flat jet of liquid impinges on the edge of a thin blade. Such devices have been used to produce insecticide emulsions, and also, probably, dispersions of other agents

Therefore, atomization of liquids and control of droplet formation by means of ultrasonics has potentially important applications for propulsion systems and the dispersal of chemical agents, as well as for the creation of mists and fogs

Various equations for predicting droplet size in an ultrasonically produced aerosol have been proposed. For instance, Popov and Goncharenko (Ref 3) have derived the following expression for prediction of droplet sizes when using atomizing whistles operating at frequencies within the range of 6.8 and 32kHz:

$$d = \left(\frac{C}{\xi}\right) (3Q\eta T / \pi D\rho^2 f^2 g \cos \alpha)^{1/3}$$

where: d = the average droplet size (microns)

C = 0.15 for d=0.1 to 0.3 and
0.3 for d=4.3

ξ = the amplitude of the vibrations (m)

Q = flow rate of liquid (m³/sec)

η = viscosity of liquid (kg-sec/m)

D = nozzle diameter (m)

g = gravitational acceleration (m/sec²)

α = angle between the spray cone and the vertical

Apparently the dispersive ability of ultrasonic devices is not limited to liquids, but has found application in the dispersion of dust. Modified Hartmann whistles operating between 10 and 15 kHz have been used to enhance the

pollination of agricultural crops (Ref 9). Riggs and Biggar (Ref 5) have produced ultrasonically aqueous suspensions of pesticides at concns which greatly exceed the theoretical solubilities of these materials in water. No emulsifiers were required and the suspensions remained stable for several days after insonification. These findings suggest the application of ultrasonics in stabilizing solid propellant slurries, and in the dispersion of chemical warfare agents

Another process technological innovation which relies on insonification reduced the hazard of blending flash compns (Ref 6). Here the separate components are layered into the bomb where they are blended *in situ* by tumbling and vibration

Written by A. P. HARDT

Lockheed Missiles and Space Co, Inc

Refs: 1) R. Courant & K.O. Friedrichs, "Supersonic Flow and Shock Waves", Interscience Publishing, NY (1948) 2) R.J. Lang, JAcoust-SocAm 34 (1) (1962), 6-8 3) V.F. Popov & G.K. Goncharenko, IsvVysshikhUchebnZaved-KhimiKhimTechnol 8 (2) (1965), 331-37 4) D.O. Miles et al, "Mechanical Shear Relaxation Spectroscopy in Experimental Viscoelasticity", JApplPolymerSci 9 (1965), 2209-25 5) R.L. Riggs & J.W. Biggar, Proc of SoilSciAm 29 (5) (1965), 629 6) D. Corey, "Method and Apparatus for Mixing and Blending Explosives", USP 3331275 (1967) 7) R.F. McAlevy III & A. Pavlak, "Tapered Resonance Tubes: Some Experiements", AIAAJour 8 (3) (1970), 571-72 8) R. Sinha, "A Theoretical Analysis of Resonance Tubes", KD 72-82, Final Rept, Contract DAAA21-72-C-0500 (Oct 1972) 9) D. Ensminger, "Ultrasonics", Marcel Dekker, NY (1973); 473 10) J.L. Koury, "Solid Strand Burn Rate Technique for Predicting Full Scale Motor Performance", AFRPL-TR-73-49, Final Rept (Oct 1973) 11) Anon, US Military Standardization Hndbk, "Ultrasonic Testing", MIL-HDBK-726 (10 June 1974) 12) D.C. Winters, "Automatic Crack Measurement System", WVT-TR-75018 (1975) 13) R.N. Gottran, "The Army and Fluidics", National Defense (May-June 1975), 464-66 14) J.W. Morris & V.P. Marchese, "Flueric Cartridge Initiation Development", ADPA Pyrotechnics and Explosives Omnibus, Los Alamos

(Oct 7-9, 1975) 15) L.H. Caveny, A.J. Saber & M. Summerfield, "Propellant Burning Rate and Combustion Uniformity Identified by Ultrasonic Acoustic Emission", **AMS Rept 1302**, Final Rept, Contract DAAA21-74-C-0332 (Jan 1976) 16) W.A. Bell, J.I. Craig & W.C. Strahle, "Audible And Ultrasonic Acoustic Emissions from Composite Solid Propellants", **AFOSR-TR-78-0009**, Final Rept (Sept 1977) 17) G.C. Knollman, R.H. Martinson & J.L. Bellin, "Ultrasonic Assessment of Cumulative Internal Damage in Filled Polymers", **JApplPhys 50** (1) (1979), 111-20 18) Anon, "Mapping Cracks on Inner Walls of Cylinders", **NTN-79/0045** (Mar 1979) (ADA 031014) 19) D.C. Winters, "Automatic Ultrasonic Detection and Measurement of Cracks in Cannon", **ARLCB-TR-79003** (1979) (ADE 440036) 20) G.C. Knollman & R.H. Martinson, "Non Linear Elastic Effects in the Ultrasonic Assessment of Cumulative Internal Damage in Filled Polymers", **JApplPhys 50** (12) (1979), 8034-37

Ultraviolet Radiation. See in Vol 9, R5-L ff under "Radiation Effects on Explosives, Propellants and Pyrotechnics"

Ultraviolet Spectroscopy. See in Vol 9, S178-L ff under "Spectroscopy of Energetic Materials"

Umbrite. See under "Italian Explosives and Related Items" in Vol 7, I181-L

Unconfined Blasts. See in Vol 2, B180-R to B182-R under "Blast Effects in Air"

Undecane, 1,1,1,4,6,6,8,11,11,11-Decanitro-4,8-Diaza.

$(O_2N)_2C(CH_2N(NO_2))_2CH_2CH_2C(NO_2)_3$, $C_9H_{12}N_{12}O_{20}$; mw 608.22; N 27.64%; OB to CO_2 -10.52%; crystals; mp 157-58° (decompn); d 1.81g/cc. Prepn is by nitration of the bis secondary amine obtained from the condensation of 3,3,3-trinitropropylamine and 2,2-dinitro-1,3-propanediol. The nitrated diaza compd exhibits a hot bar ignition temp of 202°, and an impact

sensitivity about that of PETN

Refs: 1) Beil, not found 2) L.T. Carleton & M.B. Frankel, "Research in Nitropolymers and their Application to Smokeless Propellants", **TR-660**, Aerojet-General Corp, Azusa, Cal, Contract N7-onr-462-08 (1952) 3) *Ibid*, **TR-682** (1953) 4) D.V. Sickman & W.F. Sager, "Research and Development in New Chemical High Explosives", **NAVORD 4486** (1954)

Undecanedioic Acid and Nitrated Derivatives

Undecanedioic Acid (Nonane-1,9-dicarboxylic acid). $HOOC[CH_2]_9COOH$, $C_{11}H_{20}O_4$; mw 216.31; cryst (from benz); mp 111°. Sol in ethanol; insol in petr eth. Prepn is by oxidation of cycloundecanon with Cr trioxide in acetic acid at 100°
Ref: Beil 2, 727, (295) & [612]

4,4,6,8,8-Pentanitro-Undecanedioic Acid.

$O_2N.CH[CH_2C(NO_2)_2(CH_2)_2COOH]_2$, $C_{11}H_{15}N_5O_{14}$; mw 441.31; N 15.87%; OB to CO_2 -56.20%; fine white tabular or plate crystals; mp 154° (decompn); d 1.631g/cc. V sol in acetone; sl sol in heptane and toluene; hydrolyzed by water. Prepn is in six steps. The first step is the reaction of 1,3-diacetoxy-2-nitropropane with Na methyl-4,4-dinitrobutyrate to yield 4,4,6,8,8-pentanitro-1,11-undecanedioate. The next step is the hydrolysis of this ester with 70% nitric acid, yielding a mixt of the desired pentanitro- and also 4,4,6,6,8,8-hexanitro-1,11-undecanedioic acid. Sepn of this mixt is accomplished by conversion of both products into their acid chlorides which are of different solubilities in benz, the pentanitro compd being insol and the hexanitro sol. After dissolving out the hexanitro compd, the residual pentanitro dichloride is converted to the dimethyl ester by adding it to methanol. In the final step this ester is hydrolyzed, giving the desired product in approx 10% yield

The pentanitro compd is compatible with both NC and rubber in all proportions. It has a heat of combustion of 2890cal/g; heat of formation of -277kcal at 25°; an impact sensitivity of 100+cm (RDX 50% pt is 30cm); in the 134.5° thermal stability test using methyl violet

indicating paper, it colored the paper in 8 minutes and expld in 60 minutes (NC gave no color in 30 minutes); in the 65.5° thermal stability test using starch-K iodide indicating paper, it colored the paper in 5 minutes, with no change in appearance in 5 hrs (NC gave no color in 10 minutes)

Refs: 1) Beil, not found 2) W. Brooks et al, "Research in Nitro Polymers and Their Application to Solid Smokeless Propellants", **TR-563**, Aerojet-General Corp, Azusa, Cal, Contract N7-onr-462-1 (1951)

4,4,6,6,8,8-Hexanitro-Undecanedioic Acid.

$(O_2N)_2.C[.CH_2.C(NO_2)_2.(CH_2)_8COOH]_2$, $C_{11}H_{14}N_6O_{16}$; mw 486.31; N 17.27%; OB to CO_2 -42.77%; massive, prismatic, white crystals; mp 154° (decompn); d 1.672g/cc. V sl sol in acet; sl sol in heptane; v sl sol in toluene. Prepn is in seven steps. The first step is by reaction of 1,3-diacetoxy-2-nitropropane with Na methyl-4,4-dinitrobutyrate to yield 4,4,6,6,8,8-pentanitro-1,11-undecane dioate. The next step is the hydrolysis of this ester with 70% nitric acid, yielding a mixt of the desired hexanitro and the pentanitro acids. Sepn of this mixt is accomplished by conversion of both products into their acid chlorides, dissolving the hexanitro compd in benz, and leaving the benz insol hexanitro compd. The benz soln of the hexanitro compd is evapd under vac, leaving the hexanitro compd as residue. This is added to methanol, yielding the dimethyl hexanitro undecanedioate. The final step is the acid hydrolysis of the hexanitro ester, giving the desired product in approx 10% yield

The hexanitro compd is compatible with both NC and rubber in all proportions. It has a heat of combustion of 2890cal/g; heat of formation of -277kcal at 25°; an impact sensitivity of 100+cm (RDX 50% pt is 30cm); in the 134.5° thermal stability test using methyl violet indicating paper, it colored the paper in 7 minutes and expld in 24 minutes (NC gave no color in 30 minutes); in the 65.5° thermal stability test using starch-K iodide indicating paper, it colored the paper in 3 minutes, with no change in appearance in 5 hrs (NC gave no color in 10 minutes)

Refs: 1) Beil, not found 2) W. Brooks et al, "Research in Nitro Polymers and Their Applica-

tion to Solid Smokeless Propellants", **TR-563**, Aerojet-General Corp, Azusa, Cal, Contract N7-onr-462-1 (1951)

Underground Blasts & Blasting. See in Vol 2, B182-R to B183-R under "Blast Effects in Earth (Underground Blast)"

Addnl Refs: 1) C.E. Gregory, "Explosives for North American Engineers", Trans Tech Publications, Cleveland (1973), Chaps 13 thru 20 2) Anon, EngrgDesHndbk, "Explosives Series, Explosive Trains", **AMCP 706-179** (1974), 3-17 3) Anon, "Blasters' Handbook", E.I. duPont de Nemours & Co, Inc (1977), 217-409 4) C.E. Gregory, "Explosives for Australasian Engineers", 3rd Ed, Univ of Queensland Press (1977), pp 83-145

Underwater Commercial Blasting. Underwater civil blasting includes blasting trenches across rivers to carry pipelines and cables; demolition of wrecks; cutting of piles; blasting channels thru reefs, bars and sandbanks, harbor development and improvement; and blasting sheet piling and coffer dams. It requires greater care and experience than similar operations above water because of the water cover over the rock. Some of the factors which must be considered for successful underwater blasting operations are: special drilling equipment and loading procedures; higher powder factors to displace both the rock and the water; selection of products with good water resistance and high performance under hydrostatic pressure; a safe, reliable initiation system; and vibration control using the right products and delay patterns to minimize chances of propagation (Refs 3, 5 & 7)

Where a small quantity of submerged rock is to be removed under water, it is sometimes economical to employ a diver to drill holes with a jackhammer and to charge and connect the holes for subsequent firing from the surface. With larger jobs such as deepening or construction of a harbor, special drilling equipment mounted on a drill barge designed for the purpose is generally necessary. The drill barge is equipped with spuds that can be lowered to the seabed. The spuds, which usually consist of heavy timber, reinforced with steel plate, may be

raised or lowered with steam- or compressed-air-driven hoists by means of steel-wire ropes thru top and bottom sheaves. Before dropping the spuds, the barge is positioned and secured in the desired drilling position by anchors or spring lines. The barge is then raised a few inches on the spuds to ensure a stable and level drilling platform

The drilling equipment usually consists of one or more drilling masts mounted on one side of the barge. These are generally arranged on rail tracks for ease in manipulation when "spotting" drill holes. The masts are usually high enough to accommodate the longest length of drill steel required for the deepest hole without stopping to make extensions or adjustments. The masts also support the sand pipe which is raised or lowered on guides by a hoist and cable. The sand pipe, which is "belled" at the top, is slightly larger in diameter than the gauge of bit used; it is usually of sufficient length to reach from surface to bedrock. For shallow water where wave and tidal conditions are moderate, the sand pipe can be in one piece; but when employed in deeper water in more difficult conditions, a telescopic type is used. Where drills are used under water, the sand pipe used is shorter but should extend from the bedrock thru the soft unconsolidated material on the seafloor. The purpose of sand pipe is to prevent loose material from falling into the drill hole, to guide the drill steel, and also to convey the drill cuttings away from the hole. In some cases the sand pipe is slotted near the bottom to discharge the heavier cuttings

Holes drilled for underwater blasting vary from 2½–6" in diameter, using jackhammers and down-the-hole drills. The drilling pattern must be so designed that there is no risk of unbroken rock being left above the grade level, otherwise further work becomes difficult and costly. Each drill hole charge will create a cone-shaped crater; therefore the holes must be spaced and drilled to such a depth below grade that the craters will overlap. The spacing is usually of the order of 5–10', depending on hole diameter, type and thickness of rock to be removed, and depth of water. Holes are usually drilled below grade to a distance corresponding to the spacing distance (Refs 3 & 5)

Vibration hazards are more severe in under-

water blasting because the blasting is generally done without a free face, and the conversion of the expls energy to seismic energy is normally greater in water-saturated formations than under dry conditions. Water-bearing deposits are more effective transmitters of shock waves. They increase the potential of charge-to-charge propagation, thus removing the seismic benefit of delay shooting. In areas where excessive vibrations might cause damage to nearby equipment or structures, care should be taken to reduce this hazard to a minimum. This may be done by limiting the size of individual blasts and by employing a short-interval initiating system (Ref 7, p 365)

The quantity of expls required will vary according to the depth of water and tenacity of the rock. Usually 0.5 to 2.5kg are required per m³ of rock. As a guide, 1 kg/m³ should be suitable for reasonably hard rock under 9 to 12m of water. Preliminary examination and survey by diver and sounding is usually required before determining drilling patterns, charge quantities and methods (Ref 5)

In work involving extensive underwater blasting, special expls should be used because with increasing depth of water, the sensitivity and vel of deton of the expl decreases. This effect is probably due to the minute air bubbles within the cartridges being squeezed out, thus increasing the density. To counter this effect, special expls formulated to give a high vel of deton and greater sensitivity are recommended. No special priming is necessary, except that a No 8 Al electric detonator is required. Expls recommended for underwater blasting include the high vel Gelatines. Seismic cartridges are supplied in tubes which may be screwed together by means of an outer coupler to form a rigid column of expl of any practical length. This is convenient for charging readily thru a sand pipe or charging tube. Where the sand pipe reaches to the surface, the charge of expl may be charged thru the pipe and pushed to the bottom of the hole by means of a long tamping stick. A conventional brass loading tube may also be employed. This should fit inside the sand pipe and penetrate 0.6m or so within the drill hole. The expl is then pushed to the bottom of the drill hole. Expls may also be loaded into metal shells such as stove pipe and the unit of the

required length lowered into the drill hole (Refs 3 & 5)

In addition to the "drill and blast methods" described above, a second basic blasting method for removing underwater rock is termed "doby-ing". In some cases where shallow excavation is required, dobying may be used in which charges are detonated on the rock surface without drilling holes. Conditions for which dobying might be considered are excessive water depths which cannot be easily drilled, strong tides and currents, remote areas where drilling equipment is not readily available, blasting of coral heads, and removal of high spots discovered after the drilling equipment has left. In general, a dobying shot cannot be expected to shatter rock formations to a depth of more than 3'. Dobying requires a much higher powder factor, at least three times greater than "drill" methods. The additional powder costs often can be more than justified when drilling costs are considered. The efficiency of a dobying expl depends on "coupling" or intimate contact with the rock. If sand or mud is between the charge and the rock formation, poor results can be expected. Some of the more typical methods of exposing the rock formation are blowing with a water jet, pumping with a suction dredge, or digging with a "clam" or drag bucket. In doby blasting underwater, the depth of the water is important. If the water is too shallow, excessive air blasts can be expected. Also, greater water depths increase the confinement of the expl and improve the blasting efficiency (Ref 7)

More recent advances in underwater blasting techniques have been developed with the use of shaped charges. Shaped charge expl devices offer several advantages in underwater work that have been previously impossible using bulk expls. In contrast with bulk expls, which require large amounts of demolitions, and can result in poor blast control, shaped charges produce clean, controlled, precise cutting with a minimum amount of expl. The operations can be safely controlled and, depending on the configuration and load of the shaped charge, this technology can be used to perform a variety of underwater cutting and demolition tasks. These expl devices have been utilized and have proven successful in reducing costs in time, labor and equipment required in such projects as the repair and salvage

of damaged or abandoned offshore oil platforms, the effective crushing and removal of dense coral and rock formations in underwater pipeline trenching, and for support activity in control of offshore oilwell fires (Ref 2)

This technique has been developed by the Ocean Applications Group, Jet Research Center, Inc, of Arlington, Texas. Five major types of shaped charge expl units are currently being used in offshore underwater operations (Refs 1, 2 & 4):

Straight Linear Cutters. These units consist of straight hermetically sealed expl charges available in lengths up to 10' (Fig 1)

Inside Circular Cutters. These units consist of a 360° shaped charge expl, contained in a hermetically sealed, either rigid or inflatable housing, and are used for severing underwater piling, pipe, caisson, etc (Fig 2)

Outside Circular Cutters. These units consist of two 180° hermetically sealed expl charges, hinged on one end and having a connect-disconnect latch on the other end (Fig 3). They can cleanly sever pipe, piling, caisson, etc, with a single instantaneous charge

H-Beam Cutters. These units consist of three straight linear cutters that are assembled to match the H-Beam configuration. The cutter is designed to permit simultaneous detonation of all three charges to cut each leg of the H-Beam (Fig 4)

Pipeline Trenching Charges. These charges consist of a large conical shaped container and two non-expl chemicals mixed in the proper proportions to form a liq expl (Fig 5). Trenching charges are filled at the trenching site and positioned on the trench center line from a barge or by a diver. Thru proper placement of charges, a trench of desired width, depth and length can be produced. Charges are connected in series and detonated from shore or a surface vessel

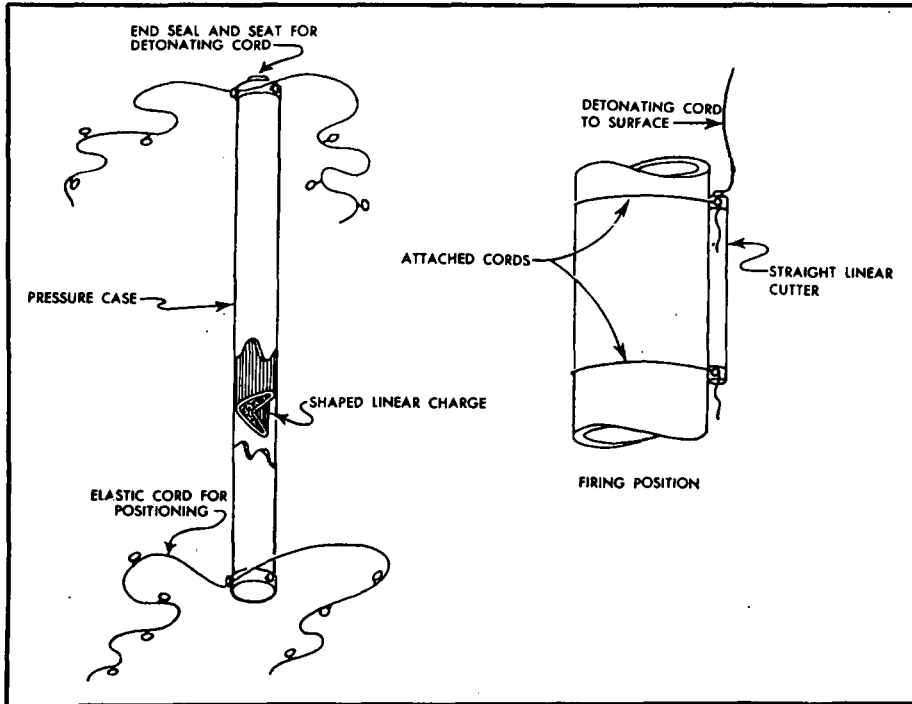

Fig 1 Straight Line Cutter

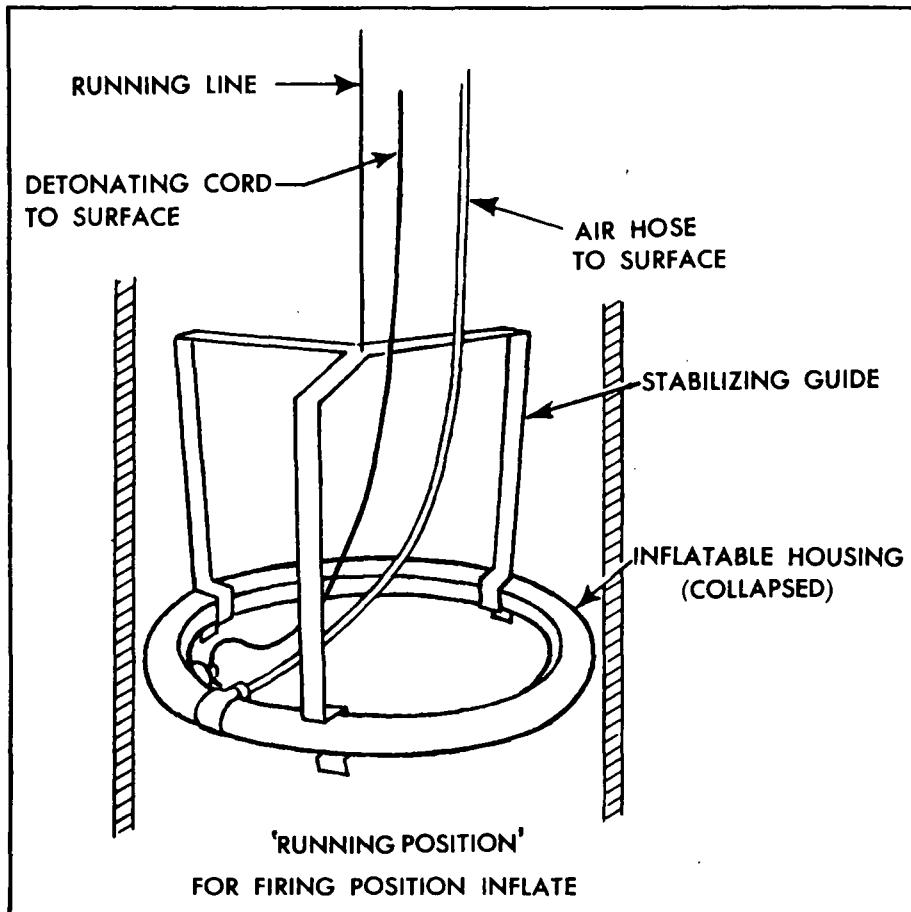

Fig 2 Inside Circular Cutter – Both Running Position and Firing Position

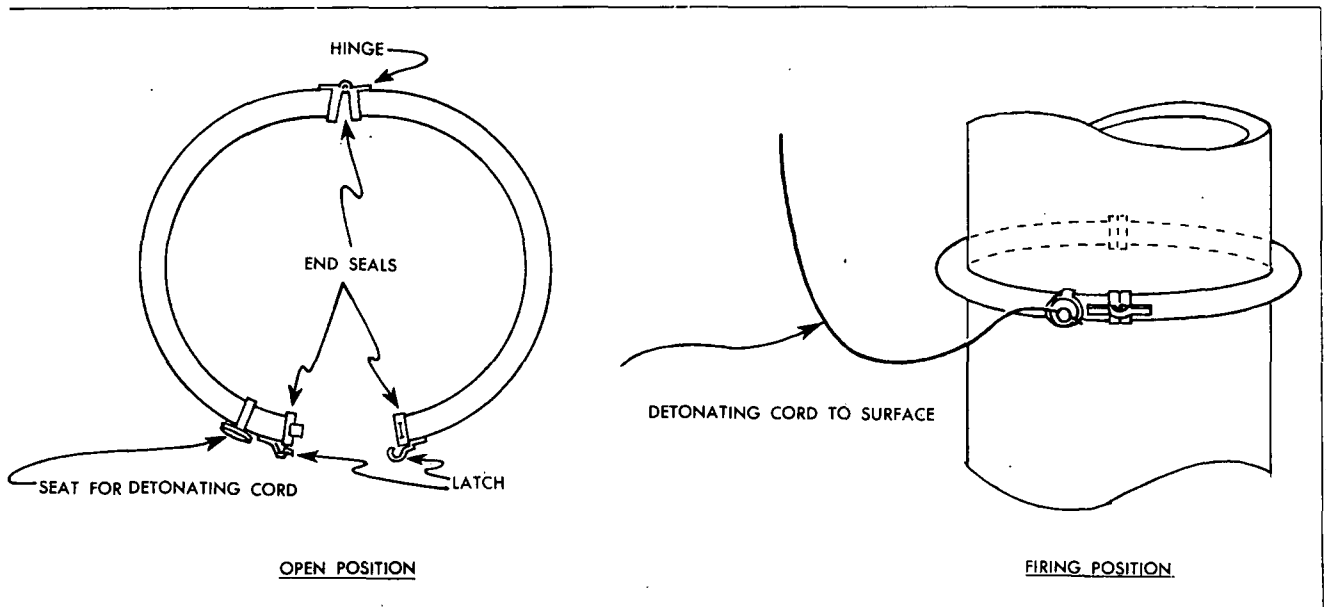

Fig 3 Outside Circular Cutter – Open Position and Firing Position

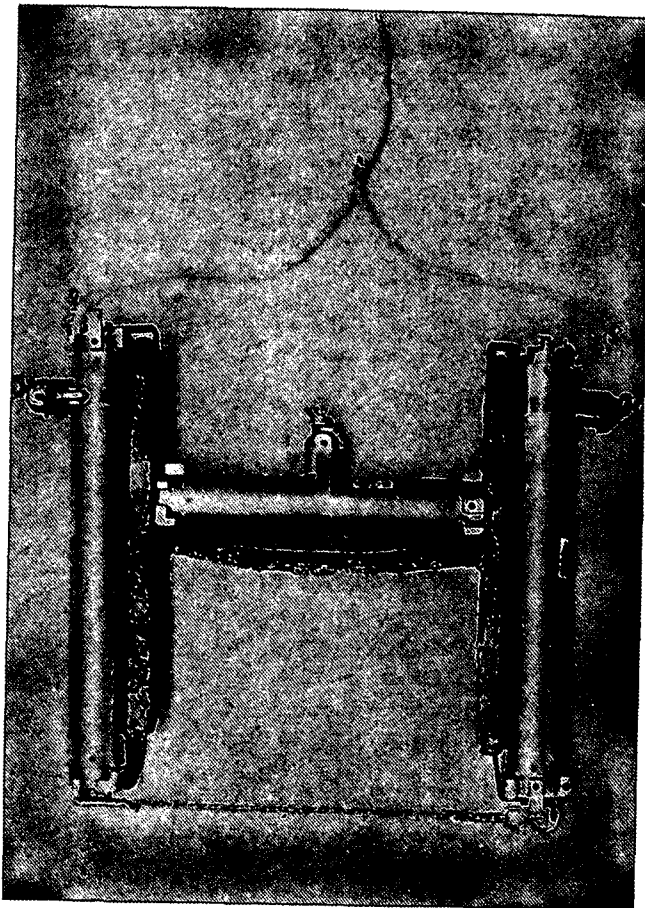

Fig 4 H-Beam Cutter and Severed H-Beam



Fig 5 Large Conical Shaped Charge Designed for Pipeline Trenching

Refs: 1) P. DeFrank, "Underwater Explosive Devices", *Offshore Technology* (July 1967)
 2) P. DeFrank & C.H. Brown, "Underwater Explosive Technology", Vol 1, Marine Technical Society, Washington, DC (1970) 3) C.E. Gregory, "Explosives for North American Engineers", Trans Tech Publications, Cleveland (1973), 205-10 4) G. Cohn, Ed, *Expls&Pyrots* 7 (5), (1974) 5) C.E. Gregory, "Explosives for Australasian Engineers", 3rd Ed, Univ of Queensland Press, Australia (1977), 121-23 6) J.S. Brower, "Guide to Underwater Explosive Excavation", J.S. Brower & Associates, Inc, Pomona (1977) 7) Anon, *Blasters' Hndbk* (1977), 365-72

Underwater Explosions

I. General Description and Definition of Terms

The detonation of a high expl charge rapidly converts the solid expl material into primarily gaseous products at very high pressure and temp. If such a detonation occurs under water, the surrounding water is subjected to a variety of forces and displacements. The dynamical properties of water (eg, its compressibility) as well as the magnitude of the force-generating phenomenon determine the nature of effects produced. The rate of propagation of the disturbance from its source thru the surrounding water is almost independent of the pressure of the source if that source is small; ie, the disturbance propagates as a sound wave

At higher source pressures, however, the disturbance generated in the surrounding water is a shock wave which propagates radially outward from the source. The subsequent history of the shock wave is influenced by the depth of water under which the original disturbance is generated. As in all shock waves, pressure rise at the shock front is extremely rapid. Pressure decay behind this shock front is nearly exponential. Peculiar to underwater explns are subsequent pressure pulses that are observed considerably later than the original shock. These pulses arise from a much slower phenomenon, namely the pulsating of the gas bubble which contains the gaseous products of the expln. The high pressure of the gas causes an initially rapid expansion of the

bubble in the surrounding water, and the inertia of the outwardly moving water carries it far beyond the point of pressure equilibrium. The outward motion stops only after the gas pressure has fallen substantially below the ambient hydrostatic pressure. Now the higher surrounding pressure reverses the motion and the bubble contracts. Again, the flow overshoots the equilibrium and when the bubble reaches its minimum size, the gas is recompressed to a pressure of several hundred atms. At this point there is in effect a second "explosion" (ie, the generation of an acoustic pulse without a shock wave), and the whole process is repeated. The bubble oscillates in this manner several times, with each successive bubble pulse becoming progressively weaker because of energy losses

Fig 1 (from Ref 17) illustrates these phenomena, for charges suspended far from both the bottom and surface of the water

The pressure-time plot shows pressure pulses which are emitted from the bubble near its minimum. Note the relatively slow rise and small amplitudes of these pressure pulses. They do not occur when the gas bubble is at its maximum. The dotted curve in Fig 1 represents the position of the bubble center as a function of time. The period of the bubble pulsations is very long when compared with the high pressure (shock wave) portion of the pressure-time history of an expln. In particular, this duration is long enough for gravity effects to become noticeable. Such a bubble has great buoyancy and, therefore, migrates upward. However, it does not float up like a balloon, but shoots up in jumps

Fig 2 (also from Ref 17) is an expanded portion of the pressure-time plot shown in Fig 1. It shows and defines some of the parameters of particular interest in underwater explns, namely: (1) shock wave peak pressure, (2) shock wave time constant, (3) shock wave impulse, and (4) shock wave energy flux density, which is often referred to simply as "energy"

Note: It is generally assumed, and empirically established, that, over ranges of interest, the shock wave pressure decays exponentially to about one time constant; after that the pressure decays more slowly. The solid curve is a truly exponential pressure decay

For the gas bubble, the important parameters are period of oscillation and maximum bubble

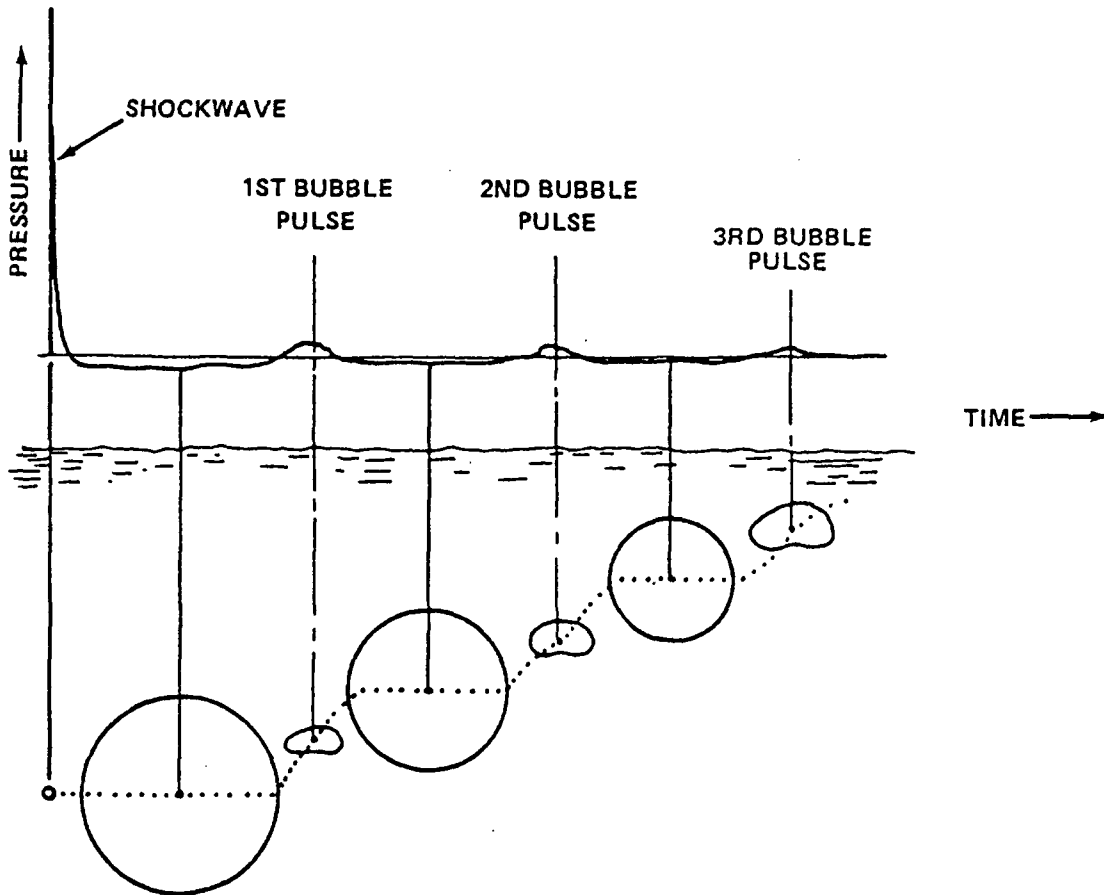

Fig 1 Pressure Waves and Bubble Phenomena of Underwater Explosions.
The Upper Part Shows a Pressure-Time Plot, the Lower, the Position and Size of the Bubble for Specific Moments which Correspond to the Curve Above as Indicated by the Vertical Lines

radius. Incidentally, note that the gas bubble is nearly spherical at its maximum and kidney-shaped at its minimum (Fig 1)

Fig 2 represents the pressure-time history of a shock in water at a given distance from the detonation of a high expl charge. Such a shock decays with distance from the charge, as shown in Fig 3 (from Ref 1). The velocity of propagation near the charge is several times greater than sonic velocity in water, but approaches sound velocity rapidly as the wave advances outward and the pressure falls to "acoustic" values. The pressure level in the spherical wave falls off more rapidly with distance than the inverse first power law predicted for small amplitudes, but eventually approaches this behavior in the limit of large

distances. The profile of the wave broadens as it spreads out (see sketches b & c)

Also shown by broken lines in sketches b & c are *hypothetical* "acoustic" waves produced by the expln. Note that, as expected, these imaginary waves travel more slowly and decay less rapidly than the shock wave

A more *quantitative* gas bubble history than that of Fig 1 is shown in Fig 4 (from Ref 1). The dashed horizontal line is the bubble radius at which the bubble pressure equals the hydrostatic pressure of the water. Note that, over most of the first bubble cycle in this example, the gas pressure in the bubble is below the surrounding hydrostatic pressure. The maximum velocity of the bubble surface is about 200ft/sec

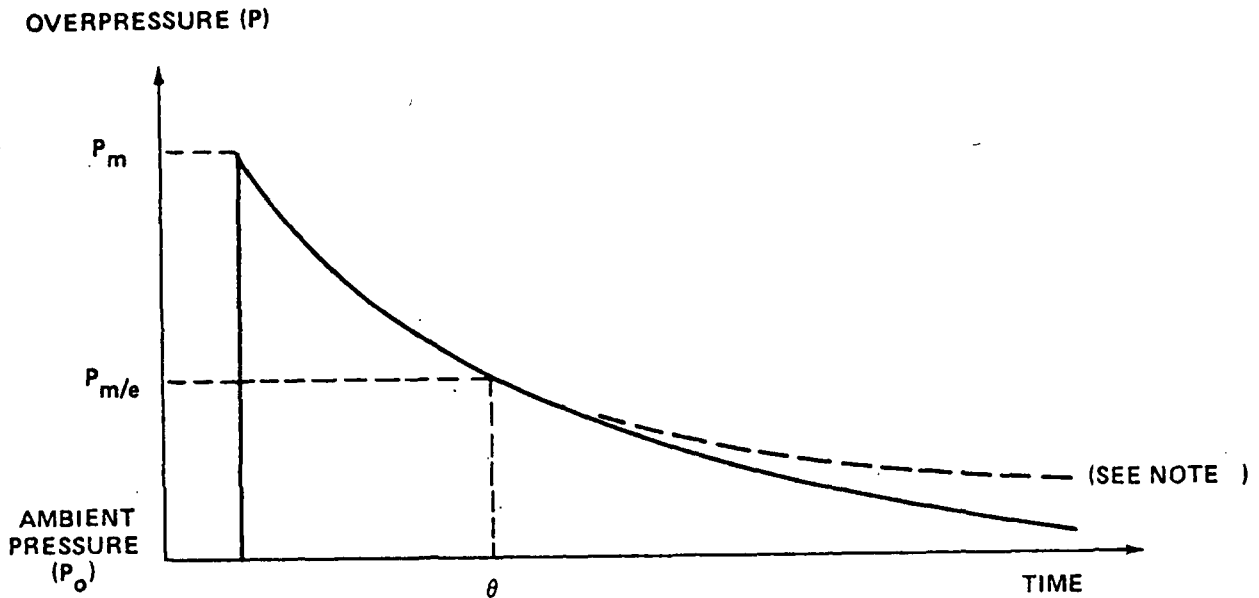

- (1) PEAK OVERPRESSURE (P) PEAK OVERPRESSURE ABOVE AMBIENT PRESSURE (ASSUMED TO BE OF THE FORM $P(t) = P_m e^{-t/\theta}$)
- (2) TIME CONSTANT (θ) THE TIME REQUIRED FOR THE PRESSURE TO FALL TO A VALUE OF P_m/e

(3) IMPULSE (I) $\int_0^t P(t)dt$ (THE INTEGRATION TIME t IS USUALLY TAKEN TO BE 5θ)

(4) ENERGY FLUX DENSITY (E) $\frac{1}{\rho_o C_o} [1 - 2.422 \times 10^{-4} P_m - 1.031 \times 10^{-8} P_m^2] \int_0^t \rho_o^2 P^2(t) dt$

WHERE THE TWO NEGATIVE TERMS REPRESENT THE CORRECTION FOR AFTERFLOW. $\rho_o C_o$ IS THE ACOUSTIC IMPEDANCE OF THE MEDIUM. (THE INTEGRATION TIME t IS USUALLY TAKEN TO BE 5θ).

Fig 2 Definitions of Shock Wave Parameters

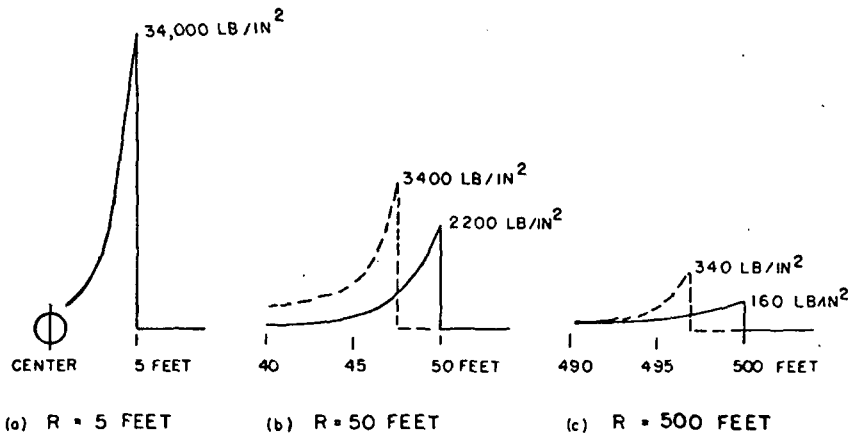

Fig 3 The Pressure Distribution Around a 300-Pound TNT Charge at 3 Times After Completion of Detonation

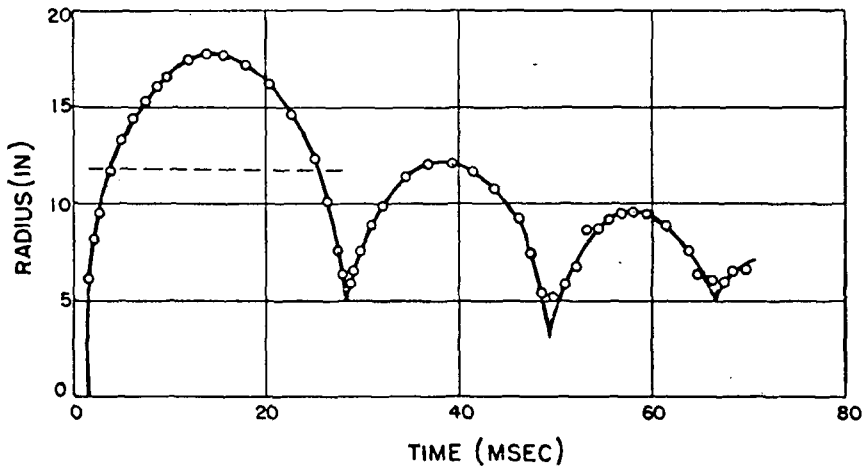

Fig 4 Radius of the Gas Sphere as a Function of Time, for a 0.55-Pound Tetryl Charge 300 Feet Below the Surface

when the bubble approaches minimum radius. The length and time scales will, of course, change with the size of charge and the depth at which it is fired, being larger for larger charges and shallower depths. In general, however, it is true that the radial velocities will be of the same order of magnitude, and that over most of the cycle the pressures will be much smaller than hydrostatic

A quantitative illustration of the relative magnitudes of shock and bubble effects is provided

in the following tabulation, taken from Ref 1, which compares shock and bubble *peak pressures, impulses* and *energy densities* measured at 60 ft from 300 lbs of TNT fired in about 100 ft of water. "Direct" bubble pulse refers to the first oscillation, while "Composite" bubble refers to the cumulative effects of the first and subsequent oscillations. Note the large difference in peak pressure attributable to shock or bubble pulses and the much smaller differences in impulse and energy density

	Depth (ft)	Peak Pressure (lb/in ²)	Positive Impulse ¹ (lb-sec/in ²)	Energy Density ¹ (in. lb/in ²)
Shock Wave	40	1770	1.15	170
	Bottom	1940	1.41	250
Composite Bubble Pulse	20	428	1.1	47
	26	71	0.84	5.9
	45	56	1.5	9.5
	65	84	4.0	18
	96	81	1.2	11
Direct Bubble Pulse	20	555	2.9	130
	26	106	2.1	16
	45	79	2.6	19
	65	93	3.4	28
	96	68	1.2	7

¹Impulse and energy values for the shock wave obtained by integration to 2.0msec after shock front, for the bubble pulse by integration over times of pressure in excess of hydrostatic.

Considerable portions of the following sections of this article will be devoted to the comparison of underwater performance of various high expls. Most of these comparisons will be in terms of the following *dimensionless ratios* defined by Swisdak (Ref 17):

- (1) *Equal Weight Ratio* (D_{wd}): The ratio of the outputs with respect to a particular parameter (peak pressure, time constant, impulse, or energy flux density) for equal weights of two expls at the same distance. (This is of interest in the design of weight-limited weapons)
- (2) *Equal Volume Ratio* (D_{vd}): The ratio of outputs with respect to a particular parameter for equal volumes of two expls as measured at the same distance. (This is of interest in the design of volume-limited weapons)
- (3) *Equivalent Weight Ratio* (W_{Dd}): The ratio of weights of two expls required to produce the same magnitude of a particular parameter at the same distance
- (4) *Relative Bubble Energy (RBE)**: The cube of the ratio of the first bubble period constants (K's):

$$RBE = \left(\frac{K_{\text{experimental}}}{K_{\text{reference}}} \right)^3$$

- (5) *Relative Potential Bubble Energy (RPBE)**: The cube of the ratio of the maximum bubble radius constants (J's):

$$RPBE = \left(\frac{J_{\text{experimental}}}{J_{\text{reference}}} \right)^3$$

*Bubble period constant and bubble radius constant are defined later

II. Uses of Underwater Explosions

The effects of underwater explns are of obvious interest in naval warfare since they determine the performance of sea mines, depth charges, torpedoes, etc. Some discussion of the military effectiveness of underwater explns will be found in later sections of this article. Underwater expln phenomena are also important in non-military underwater blasting. Here it often becomes important to minimize damage to nearby underwater structures rather than to destroy them

In recent years it has become popular to characterize the "effectiveness" of industrial expls in terms of their measured underwater shock and gas bubble effects (Refs 6, 18 & 21). For example, it is claimed (Refs 6 & 21) that measured gas bubble energies correlate well with performance of the expl in breaking rock

Study of underwater expln has also contributed appreciably to a better understanding of detonations and detonation effects. For example, underwater expl studies have elucidated the transformation of the chemical energy of the expl into other forms of energy such as shock

energy, motion energy of the medium, and residual energy of the detonation products. The theoretical aspects of underwater expln will be considered in Section VII

Liddiard (Ref 5) used spherical shocks in water to study the initiation of deflagration and detonation of Pentolite, Cyclotol, TNT, PBX 9404 and LX-04-1. He concluded that the deflagration threshold in water is lower than in the more conventional *gap test* geometry (See under "Shock Sensitivity of Explosions" in Vol 9) because in water the input shock is of longer duration and lesser curvature than in the gap test

The writer (Ref 3) investigated the controlling expl and metal parameters in the forming of metals by expls. The medium for transmitting the expln effects to the metal was water. To form flat metal sheets into hemispherical or conical shapes the controlling expl parameter was found to be the shock energy flux (E in Fig 2) at the water/metal boundary, and the controlling metal parameters are metal yield strength and thickness

III. Underwater Explosion Measurement Techniques

The measurable underwater *shock wave parameters*, namely peak overpressure, pressure decay and shock velocity were defined in Fig 2. Actual pressure time records are similar to the idealized sketch of Fig 2, but unfortunately they are rarely as "neat". *Peak overpressures* and *time constants* can be read directly from such records. *Impulse* ($\int p dt$) and *Energy Flux Density* ($\text{const} \times \int P^2 dt$) require either analytical or graphical integration. *Shock velocity* is obtained from arrival times, ie, the time between firing of the expl charge and the start of the steeply rising pressure pulse

A more detailed representation of the shock and bubble pulses than that of Fig 1 is shown in Fig 5 (taken from Ref 17). Definitions and units of the various phenomena illustrated are given in Table 1. These definitions will be needed in the immediate and subsequent discussions of underwater explns

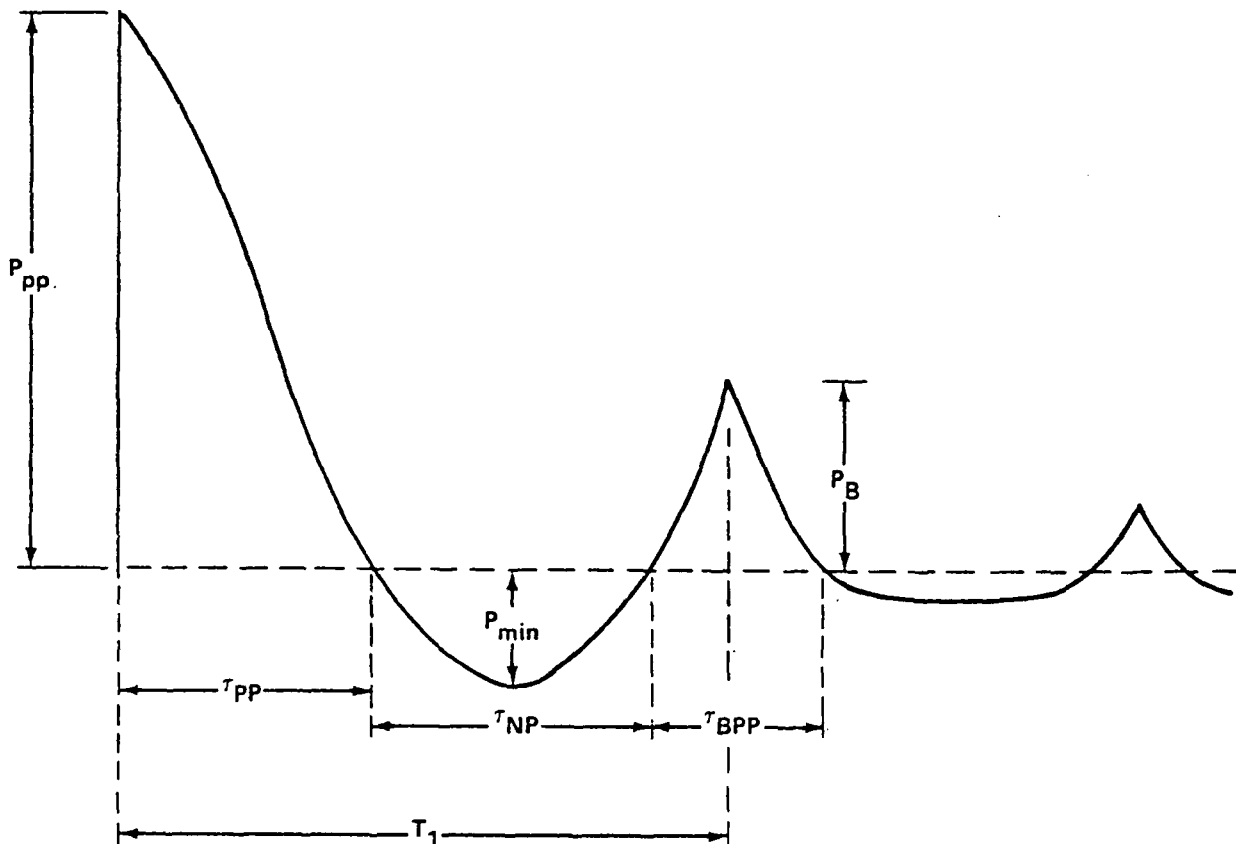

Fig 5 Pressure-Pulse Characteristics of Deep Explosions

Table 1
Definition of Symbols

P_{pp}	Peak Pressure of the First Positive Phase (MPa)
P_B	Maximum Pressure of the First Bubble Pulse (MPa)
P_{min}	Minimum Pressure of the First Bubble Negative Phase (MPa)
τ_{pp}	Positive Phase Duration (s)
τ_{np}	Negative Phase Duration (s)
τ_{bpp}	First Bubble Phase Duration (s)
T_1	First Bubble Period (s)
I_{pp}	Impulse of the First Positive Phase (kPa-s)
I_B	First Bubble Pulse Impulse (kPa-s)
E_{pp}	Energy Flux Density of the First Positive Phase (M-kPa)
Z_0	Charge Depth in Meters +10
W	Charge Weight (Kilograms)
R	Slant Range to Charge (Meters)
k, α, β	Least Squares Fit Constants (Coefficients and Exponents)

As far as directly measurable *bubble parameters* are concerned, the ones shown in Fig 5 are the period of oscillation of the first bubble (T_1), the max pressure of the first bubble pulse (P_B) and first bubble phase duration (τ_{bpp}). Of these parameters, T_1 is by far the most important. Another measurable quantity (not shown in Fig 5) is the max bubble radius, A_{max} .

Note that m-k-s units are used in Table 1 as well as in most of the subsequent discussions. Table 1A (from Ref 17) shows conversion factors to the English units (eg, psi) in which much of the early data are reported

With the qualitative illustration of observable shock and bubble parameters shown in Fig 5, we can now proceed to a description of the test methods used to obtain such data. Figs 2 & 5 immediately suggest the use of pressure transducers to follow the pressure-time histories of underwater explns. Similarly Fig 1 (bottom portion) suggests the use of visual (photographic) techniques to obtain dimensions and positions of the gas bubbles. Indeed, these are the major techniques now used in studying underwater shock and bubble effects

The most commonly used pressure transducers are piezoelectric gages, commonly quartz or tourmaline. The output of these gages (usually as voltage-time plots) is recorded oscillographically. To convert the vertical deflections on the oscillo-

Table 1A
Conversion Factors

To Convert	Into	Multiply By
Meters	Feet	3.281
Kilograms	Pounds	2.2046
Megapascals (MPa)	psi	145.038
$m/kg^{1/3}$	$ft/lb^{1/3}$	2.5208
$kg^{1/3}/m$	$lb^{1/3}/ft$	0.3967
$kg^{1/3}$	$lb^{1/3}$	1.3015
$m/kg^{1/4}$	$ft/lb^{1/4}$	2.6929
kPa-s	psi-sec	0.14504
$kPa-s/kg^{1/3}$	$psi-sec/lb^{1/3}$	0.11144
m-kPa	in-psi	5.7073
$m-kPa/kg^{1/3}$	$in-psi/lb^{1/3}$	4.3852
$m^{4/3}/kg^{1/3}$	$ft^{4/3}/lb^{1/3}$	3.7453
$m^{5/6}/kg^{1/3}$	$ft^{5/6}/kg^{1/3}$	2.0678
kg/m^3	lb/ft^3	0.06243
Feet	Meters	0.3048
Pounds	Kilograms	0.4536
psi	MPa	0.0068946
$lb^{1/3}$	$kg^{1/3}$	0.7683
$ft/lb^{1/3}$	$m/kg^{1/3}$	0.3967
$lb^{1/3}/ft$	$kg^{1/3}/m$	2.5208
$ft/lb^{1/4}$	$m/kg^{1/4}$	0.3714
psi-sec	kPa-s	6.8947
$psi-sec/lb^{1/3}$	$kPa-s/kg^{1/3}$	8.9738
in-psi	m-kPa	0.17521
$in-psi/lb^{1/3}$	$m-kPa/kg^{1/3}$	0.22804
$ft^{4/3}/lb^{1/3}$	$m^{4/3}/kg^{1/3}$	0.2670
$ft^{5/6}/lb^{1/3}$	$m^{5/6}/kg^{1/3}$	0.4836
lb/ft^3	kg/m^3	16.017

scope trace to pressures requires calibration curves. These are obtained by recording the output of a gage sealed in a hydraulic chamber and pressurized to a known pressure by a dead weight press, at the instant of pressure relief via a quick-acting release valve (Ref 11). Alternatively, adequate calibration can often be obtained by firing charges of "standard" expls whose underwater expln effects have been previously determined (Refs 11 & 19). The choice of a "standard" expl and "standard" method is a subject of considerable current interest. This subject will be addressed in Section V

The time scales of modern oscilloscopes are highly accurate. Furthermore, they carry internal standards for time calibrations to check their timing accuracy. Cole (Ref 1, Chapt 5) devotes

considerable space to a description of spurious signals arising from improperly matched amplifiers and signal cable noise. With present-day equipment these problems have largely disappeared, eg, thru the use of anti-microphonic cable (Ref 21)

According to Ref 16: "Underwater tests were proposed a few years ago as a means of comparing the relative effectiveness of various explosives. This proposal was based on the hypothesis that "shock energy" from an explosion underwater measures the explosive's shattering action in other materials, such as rock, and that "bubble energy" from the underwater explosion was the "heaving action" of the explosive. The shock energy in the tests is the compressional energy radiated from an underwater detonation and is derived by measuring the area under the pressure squared-time curve at a known distance from the explosion. The bubble energy is the potential energy of the displaced water at the maximum size of the bubble. It is derived by measuring the elapsed time between the shock wave and the pulse emitted by the first collapse of the gas bubble, knowing the ambient hydrostatic and atmospheric pressure acting on the gas bubble.

In this test the total explosive energy was postulated to be the sum of the shock wave and bubble energies

In addition to measuring shock wave and bubble energies, underwater tests also can measure the shock wave impulse, another indicator of explosive strength. The shock wave impulse is derived by measuring the area under the pressure-time curve for a selected integration time interval at a known distance from the explosion

A schematic diagram, Figure 6, shows a typical underwater test configuration and oscilloscope record used to determine shock wave impulse. The pressure vs. time is displayed both at fast and slow scope speeds and the impulse vs. time at the faster scope speed. The impulse vs. time is electronically integrated from the pressure vs. time signal from the pressure gauge. The slower scope speed record is used to measure the time interval between the shock wave and the first bubble pulse. The integration time of the shock wave impulse is taken as a fixed percentage of the bubble period"

Other pressure transducers, such as *crusher gages*, *ball crusher gages*, *Hilliard gages* and *diaphragm*

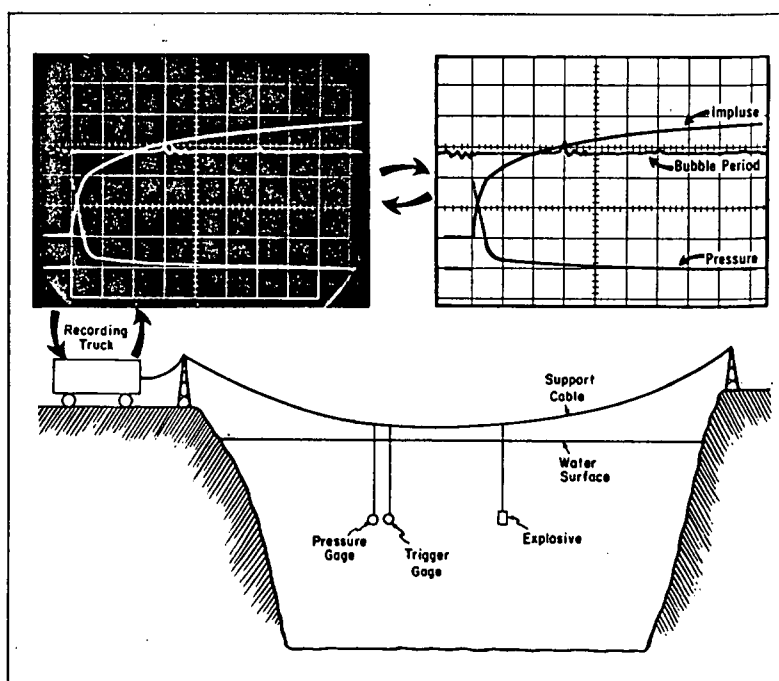

Fig 6 This diagram shows an Underwater Test Configuration and the oscilloscope record used to determine shock wave impulse (positive of the record at right)

gages are described by Cole (Ref 1, Chapt 5), and in Vol 3, C336-L to C340-R. They are infrequently used at present

Photographic techniques for recording bubble size and motion are described by Cole (Ref 1, Chapt 5). Basically they involve taking ultra high speed movies of underwater explns. Frequently this requires the use of very intense light sources, such as Argon flash bombs, to obtain sufficient illumination. It is apparent that such photographic techniques are not easily instrumented in mid-ocean or even in a large pond. Consequently most of these studies were made with small-scale aquarium-type models

Cole (Ref 1, p 380) states that pressure gages should be placed at least 2 max bubble radii away from the expl charge in order to avoid spurious signals. For similar reasons, as well as for survivability and reliability of the gage, Bjarnholt (Ref 21) suggests that gages for routine measurements be placed at $3.5 < R/W^{1/3} < 7m/kg^{1/3}$, where R is the distance from the center of the gage to the center of gravity of the expl charge, and W is the charge weight

Geometry of the expl charge is important in measurements at small *reduced distances* (ie, small values of $R/W^{1/3}$). Ideally, charge geometry should be spherical with center initiation. Unfortunately, most practical charges in underwater blasts are not spherical. Thus both exptl and theoretical studies are necessary to evaluate the effects of the non-sphericity of the initial disturbance. Exptl studies of Bjarnholt (to be described later) suggest that for routine work the

effects of charge geometry are relatively small, as shown in Fig 7 (from Ref 21) by the small variation of the "shape factor", k_f

The conclusion that charge geometry has relatively little effect on underwater expln parameters, measured not too close to the charge, is also reached by Christman & Lings (Ref 19)

IV. Scaling Laws

We have already implied that underwater expln parameters depend on the distance from the charge at which the parameters are observed and on charge weight. We will now consider the quantitative dependence of these parameters on both distance from and weight of the expl. These relationships are known as *scaling laws* or *similitude equations*

The basis for these relationships is that the profile of the detonation wave of the charge is spread out as a shock in water in proportion to the amount that the wave has advanced but *in the same form* as the original wave, *except for a change in scale*. We quote Cole (Ref 1, Chapt 4): "If the time required to establish the steady condition is negligible, the profile of the wave is the same for all geometrically similar charges, provided the scales of length and time used to specify it are proportional to the linear dimensions of the charge and the origins of time and distance are at the point of initiation. This is just the necessary condition for similarity to be established in the water shock wave and the remaining question is as to whether the boundary conditions at the interface of the explosion products

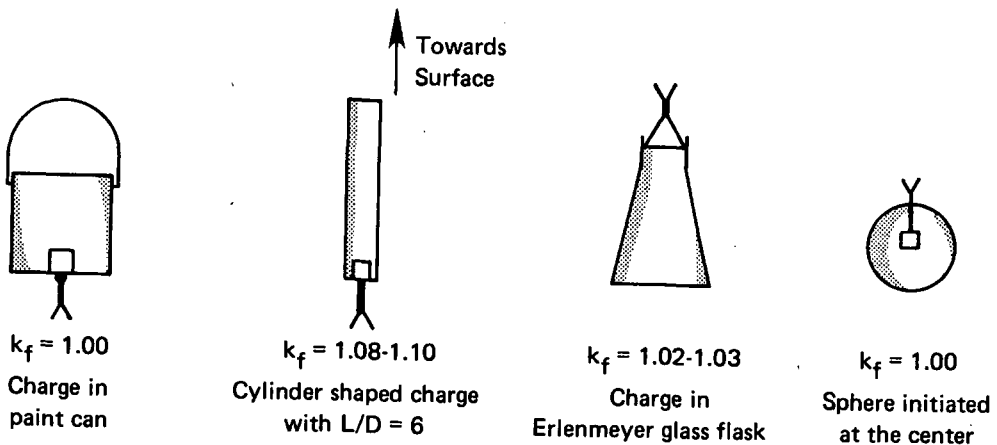

Fig 7 Charge Shapes and Charge Shape Factors k_f

and the water are compatible with similarity. In the absence of viscosity effects (shear), these conditions require continuity of pressure and normal components of particle velocity. We can easily convince ourselves that these conditions are satisfied if pressures and particle velocities are scaled geometrically, and the approximate relations so far developed to account for the shock wave are thus all consistent with the principle

Deferring for the moment an examination of circumstances in which the principle of similarity fails, we consider what can be inferred with its aid about the form of the shock wave. The fact that the pressure and other properties are unchanged if the linear dimensions of the source and scales of length and time are all changed in the same ratio does not of course specify what the values are without other information. It is possible, however, to learn something about their functional dependence on charge size and distance. If the linear dimensions of the charge are specified in terms of a length, a_0 , the principle can be satisfied only if the pressure depends on distance and time only as a function of the ratios r/a_0 , t/a_0 . The truth of this statement is evident from the fact that fixed values of these ratios correspond to the scaling which gives identical values of the pressure. The pressure P_m at the head of the shock wave (peak pressure) may therefore be expressed

$$P_m = f\left(\frac{a_0}{r}\right)$$

the form of the function f being undetermined. If the quantity θ is used to represent any measure of time duration of the wave, e.g., the time constant of an exponential decay, it is evident that θ/a_0 can be a function only of the ratio a_0/r . Another important property of such a wave is the impulse associated with it, which measures the momentum imparted to the water by its passage. For unit area of the wave front the impulse I is given by

$$I(r, t') = \int_0^{t'} P(r, t) dt$$

where the origin of time is taken to be arrival of the shock front at r . The time t' to which the integration is carried should, for consistency, be taken proportional to the scale factor and we write $t' = Ka_0$, where K is a function only of

a_0/r , and the pressure P depends on r and t only by the ratios a_0/r , t/a_0

We may therefore write

$$I(r, t') = a_0 \int_0^{K\left(\frac{a_0}{r}\right)} P\left(\frac{a_0}{r}, \frac{t}{a_0}\right) d\left(\frac{t}{a_0}\right)$$

and, the integral being a function only of a_0/r , we obtain

$$I(r, t) = a_0 g\left[\frac{a_0}{r}, K\left(\frac{a_0}{r}\right)\right]$$

where g is an undetermined function"

A similar though less detailed presentation of scaling laws is given in Chap 13 of Ref 10

In practice, shock wave scaling laws for various expls are expressed as shown in Table 2 from Ref 17

For comparison, the older measurements for TNT (Cole, Ref 1) agree exactly with those in Table 2, but Cole's values of K and α for 50/50 Pentolite are slightly different, namely, 54.6 and 1.13 respectively for P_m and 74.1 and 1.05 for $I/W^{1/3}$. The larger difference for the coefficients of $I/W^{1/3}$ arises largely from a longer integration time, namely 6.7θ for Cole vs 5θ in Table 2. Khristoforov (Ref 2) expresses P_m , θ and I for PETN and Pb Azide spheres in similar forms to those shown in Table 2. His results, converted to the units of Table 2, are given in Table 3

Scaling of bubble parameters in free water differs from scaling of shock effects, because for the former one must consider the effects of hydrostatic pressure on the bubble (depth of water) and of the internal pressure of the gas bubble. However, over most of the oscillation cycle one can neglect the effects of internal gas pressure since it is relatively small except at the time when the bubble is near its minimum size. With this approximation it is expected that the appropriate scaling factors are charge weight and depth of water above the charge. For a detailed discussion of the basis for bubble scaling laws see Cole (Ref 1, Chapt 8)

The actual forms of the scaling laws for bubble period and bubble radius are shown below. Note that these relations hold only if the charge is fired in *free water*, ie, at least 10 max bubble radii from either the surface or bottom (Ref 17)

Table 2
Similitude Constants and Coefficients for Various High Explosives

Explosive	P_m		$\theta/W^{1/3}$		$I/W^{1/3}$		$E/W^{1/3}$		Range of Validity*
	K	α	K	α	K	α	K	α	
TNT	52.4	1.13	0.084	-0.23	5.75	0.89	84.4	2.04	3.4-138
Pentolite	56.5	1.14	0.084	-0.23	5.73	0.91	92.0	2.04	3.4-138
H-6	59.2	1.19	0.088	-0.28	6.58	0.91	115.3	2.08	10.3-138
HBX-1	56.7	1.15	0.083	-0.29	6.42	0.85	106.2	2.00	3.4-60
HBX-1**	56.1	1.37	0.088	-0.36	6.15	0.95	107.2	2.26	60-500
HBX-3	50.3	1.14	0.091	-0.218	6.33	0.90	90.9	2.02	3.4-60
HBX-3**	54.3	1.18	0.091	-0.218	6.70	0.80	114.4	1.97	60-350

NOTE: All equations are of the form $\text{Parameter} = K \left(\frac{W^{1/3}}{R} \right)^\alpha$

P_m = Peak Pressure (MPa)

$\theta/W^{1/3}$ = Reduced Time Constant (ms/kg^{1/3})

$I/W^{1/3}$ = Reduced Impulse (kPa-s/kg^{1/3})

$E/W^{1/3}$ = Reduced Energy Flux Density (m-kPa/kg^{1/3})

W = Charge Weight in Kilograms (kg)

R = Slant Range in Meters (m)

I and E are integrated to a time of 5θ

*Validity Range is range of the pressure (in MPa) over which the equations apply

**Equations are based on limited data beyond about 130MPa, and should be used with caution

***Shock wave is not exponential, but has a hump; the similitude equation fits the portion of the wave beyond the hump.

Table 3
Similitude Constants and Coefficients
for PETN and Pb Azide

Explosive	Density	P_m		$\theta/W^{1/3}$		$I/W^{1/3}$ *		$R/W^{1/3}$ range
		K	α	K	α	K	α	
PETN	1.2-1.6	65.3	1.20	0.085	0.3	7.57	0.92	0.3-15
Lead Azide	1.6	23.3	1.08	0.125	0.1	4.31	0.92	0.18-10

*Integrated over 5.5θ

$$K = T \frac{Z^{5/6}}{W^{1/3}}$$

$$J = A_{\max} \frac{Z^{1/3}}{W^{1/3}}$$

where:

K = Bubble period coefficient
($s-m^{5/6}/kg^{1/3}$)

T = First bubble period (s)

Z = Hydrostatic pressure (charge depth (H) in meters + atmospheric head (H_0), also in meters - approximately equals $H + 10$)

W = Charge weight (kg)

J = Bubble radius coefficient ($m^{4/3}/kg^{1/3}$)

A_{\max} = Maximum bubble radius (m)

V. "Standard" Underwater Explosive and "Standard" Test Environment

As already stated, there is a need for a standard reference expl for underwater expln parameters. Hicks et al (Ref 11) recommend the use of crystalline TNT isostatically pressed to a density of $1600kg/m^3$. The geometry of this standard charge is a 1:1 right cylinder with initiation at its center. The preferred charge weight is 0.45kg. Boostering, if used, should be limited to $\leq 1\%$ of the charge weight

In arriving at the above recommendations, Hicks et al measured P_m , θ , I and E as functions of charge weight, charge to gage separation, charge geometry, and point of initiation (center or end). Tourmaline piezoelectric gages were employed. Measurements were made over the reduced distance range of about 1.3 to $6.3m/kg^{1/3}$

We quote the conclusions of their study: "(a) The reduced impulse/stand off relationship appears to be the same, no matter the size, shape or mode of initiation. This is probably our most important observation.

b) The other parameters measured (peak pressure, time constant, E) for the cylindrical charges are dependent on the charge size and initiation geometry at the smaller stand off distances. These effects are small for centre-initiated charges, significantly worse for end-initiated, but in the former case diminish at the larger distances.

It was not possible to distinguish between the parameters for 0.45kg centre-initiated cylinders and 0.45kg spheres.

c) The reproducibility of the results for the 0.45

kg and larger charges is good (by underwater shock data standards), indicating the reliability of the manufacture and output of pressed TNT charges and the adequacy of the small booster systems (less than 1 per cent by weight). The 0.1 and 0.05kg charges showed a larger scatter in their data, being greatest for the end-initiated charges, although the means values agreed well with those of the larger charges.

d) The consistency of the data from centre-initiated charges is better than from end-initiated cylinders and the experimental scatter is less.

e) The effect of charge density on shock parameters is small but just detectable. Concurrent work (Part 2 of this report) shows that the density should be specified to within 1 per cent.

f) The sensitiveness of isostatically pressed TNT charges is adequate and roughly constant for the density range covered ($1500-1620kg/m^3$); it is comparable with that of cast Composition B."

Bjarnholt (Ref 21) examined the "routine" determination of underwater expln parameters. A convenient body of water for such tests is a pond. To enable comparison of a set of tests made at one laboratory with those obtained at other laboratories, Bjarnholt suggests standardization of:

Charge geometry and initiation

Charge depth and distance between charge and gage

Pressure gages

He points out that appropriate charge dimensions must be selected to avoid non-ideal detonation, particularly so if one is testing commercial expls such as ANFO or slurries. Attainment of ideal detonation also requires good initiation by properly positioned powerful initiators

Some additional considerations that are particularly applicable to testing commercial expls are as follows (from Ref 21):

"When an explosive is immersed in water it will be exposed to the hydrostatic pressure at the charge depth. For some explosives the compression caused by this hydrostatic pressure will influence initiation sensitivity and detonation performance considerably. One may therefore have to consider the choice of charge depth or the use of a charge with a casing that will take the hydrostatic pressure and leave the explosive unaffected.

If the casing of the charge is made of easily combustible material it may take part in the explosive reactions and cause a change in the reaction products composition such that performance is affected. For a relatively strong casing like a steel tube the energy expended in demolishing the casing may also have to be taken into account.

For some homogeneous explosives detonation performance is strongly influenced by the density and sound velocity of the charge casing.

The placement of the initiator should be well controlled because bad "corner turning ability" of the detonation wave in some explosives may otherwise cause partial decomposition of different parts of the charge.

Especially for nonideal explosives charge shape and size should if possible resemble that of the intended application. Deviations from spherical charge shape should, however, not be too large. Length to diameter ratios over 10 should be avoided because shock energy evaluation with only one gage assumes spherical symmetry in shock wave parameters."

Christman and Lingens (Ref 19) consider essentially the same test variables as Bjarnholt and arrive at very similar conclusions

VI. Measured Underwater Explosion Parameters

In Section I we defined the principal underwater expln parameters, and in Section V we showed how these parameters vary with expl charge weight and with distance from the charge. Below we will present *quantitative data* on these expln effects. Because TNT in the form of spheres is almost universally accepted as the *standard* underwater charge, much of what follows will concern spherical TNT charges, and most of the data are taken from an excellent summary of underwater expln effects edited by Swisdak (Ref 17)

The nomogram in Fig 8 (from Ref 17) summarizes the underwater *shock* effects of spherical TNT charges fired in deep water. To illustrate the use of this nomogram consider the following problem: what are the underwater shock effects at 10 meters from a 1000kg spherical TNT charge? The solution to this problem is obtained simply by drawing a line (as shown in Fig 8) between 1000 on the W scale and 10 on the R scale

and reading: I = 57, E = 810 and P = 52 respectively on the I, E and P scales. To obtain θ , connect 1000 on the W scale with 10 on the R(m) scale, to read 0.82 on the θ scale

Table 4 (from Ref 17) presents additional shock effects, as well as bubble effects, for deep underwater explns of TNT. The symbols in this Table were defined in Table 1 and shown schematically in Fig 5. Table 4 also shows the reduced distance range covered by these measurements

Fig 9 (from Ref 17) is a nomogram for the *period* and *max radius* of the first bubble generated by a TNT expln in deep water. Use of this nomogram is analogous to that described for Fig 8

The equations upon which the nomogram of Fig 9 is based are:

$$T = K \frac{W^{1/3}}{(H + H_0)^{5/6}}$$

$$A_{\max} = J \frac{W^{1/3}}{(H + H_0)^{1/3}}$$

Where the symbols have the following definitions:

- A_{\max} = Maximum bubble radius (meters)
- T = Period of oscillation (seconds)
- W = Charge weight (kilograms)
- H = Depth of charge (meters)
- H_0 = Atmospheric head = 10 meters
- K, J = Bubble coefficients dependent upon expl

For TNT, $K = 2.11 \text{ s} \cdot \text{m}^{5/6} / \text{kg}^{1/3}$ and $J = 3.50 \text{ m}^{4/3} / \text{kg}^{1/3}$

K and J values for other expls will be presented later (in Table 7)

The various factors (equal weight ratios) used to compare shock and bubble effects of different expls were described in Section I. In practice, any parameter of interest is obtained by multiplying the corresponding parameter of a standard expl (usually TNT) by the appropriate equal weight ratio. The following caveat should be noted:

For a given series of underwater expln tests, the shock wave parameters relative to a standard expl are determined from lines fitted to the data by the method of least squares. Hence, the slopes of the similitude lines reported in the various references cited vary somewhat. The Equal Weight Ratios about to be presented in Table 5 *assume* a constant slope for all expls for each of the four parameters shown. This seems to be a reasonable

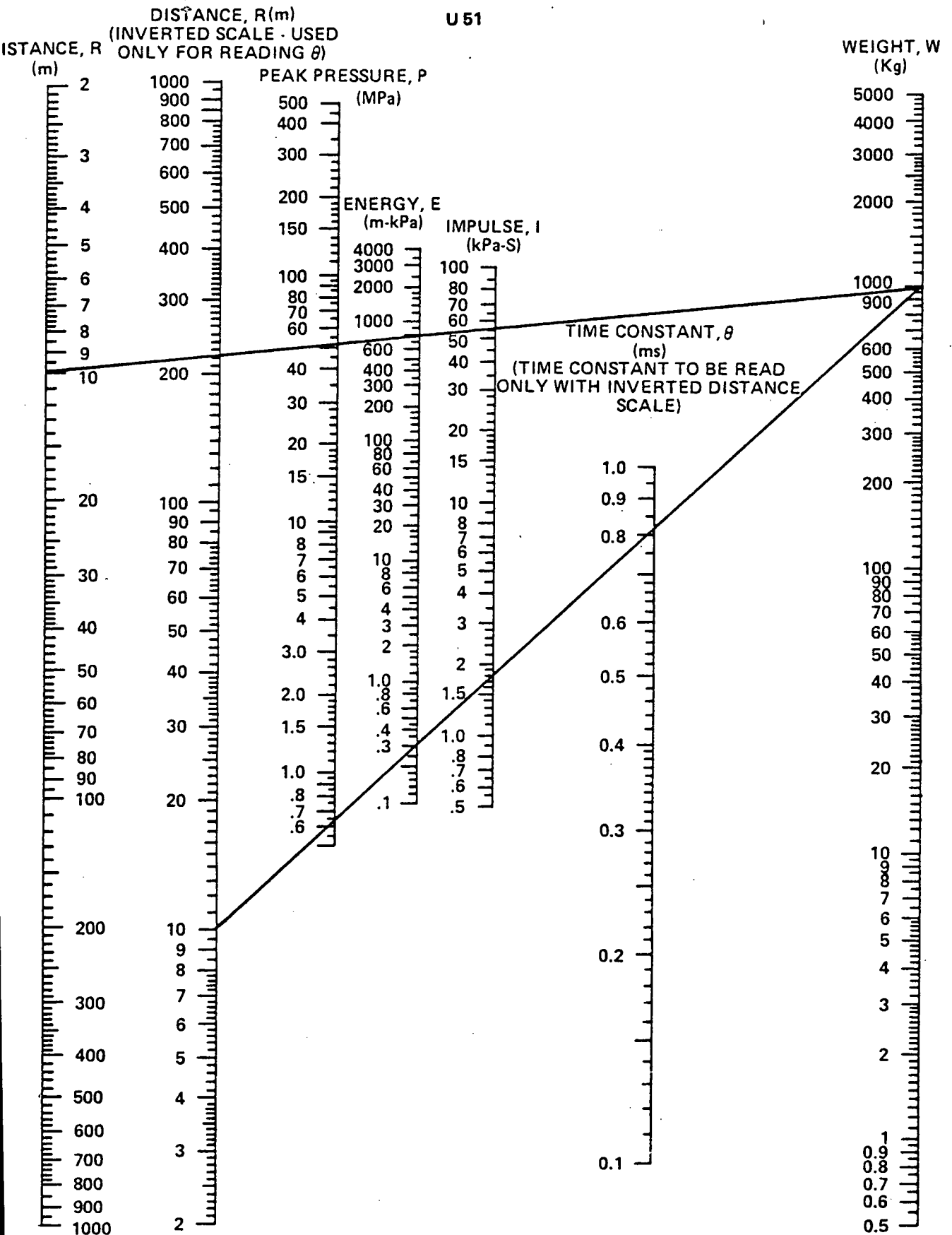

Fig 8 Underwater Shock Wave Parameters from a TNT Charge

Table 4
Pressure Pulse Characteristics of Deep TNT Explosions

The Pressure Pulse Characteristics are presented in equations of the form:

$$Y = k Z_0^\alpha (R/W^{1/3})^\beta$$

Y	k	α	β	Limits of Variable
P_{pp} (MPa)	50.4	0	-1.13	$5500 \geq R/W^{1/3} \geq 79$
P_B (MPa)	9.03	0	-1.00	$1219 \geq Z_0 \geq 152$
P_B (MPa)	2.917	1/6	-1.00	$4572 \geq Z_0 \geq 1219$
P_{min} (kPa)	-312.94	1/3	-1.00	$4267 \geq Z_0 \geq 1372$
P_{min} (kPa)	-28.987	2/3	-1.00	$1372 \geq Z_0 \geq 152$
$I_{pp}/W^{1/3}$ (kPa-s/kg ^{1/3})	36.2	-1/3	-0.97	$5500 \geq R/W^{1/3} \geq 198$
$I_B/W^{1/3}$ (kPa-s/kg ^{1/3})	85.2	-2/5	-1.00	$3174 \geq R/W^{1/3} \geq 198$
$E_{pp}/W^{1/3}$ (m-kPa/kg ^{1/3})	214.9	-1/5	-2.07	$5500 \geq R/W^{1/3} \geq 198$
$\tau_{pp}/W^{1/3}$ (s/kg ^{1/3})	0.268	-5/6	0	$1372 \geq Z_0 \geq 152$
$\tau_{pp}/W^{1/3}$ (s/kg ^{1/3})	0.0117	-2/5	0	$6706 \geq Z_0 \geq 1372$
$\tau_{np}/W^{1/3}$ (s/kg ^{1/3})	1.499	-5/6	0	$4267 \geq Z_0 \geq 198$
$\tau_{bpp}/W^{1/3}$ (s/kg ^{1/3})	0.532	-5/6	0	$1372 \geq Z_0 \geq 198$
$\tau_{bpp}/W^{1/3}$ (s/kg ^{1/3})	0.099	-3/5	0	$6706 \geq Z_0 \geq 1372$
$T_1/W^{1/3}$ (s/kg ^{1/3})	2.098	-5/6	0	$4267 \geq Z_0 \geq 198$

assumption for most expls and should give shock wave parameters which fall within the normal scatter

Occasionally it is desired to compare expls on the basis of shock pressure and/or relative bubble energy. Table 6 (from Ref 17) shows the weight ratios for several expls relative to Pentolite. If the weight ratio is greater than unity, the expl is more "powerful" than Pentolite, and conversely

The charges used to obtain the values shown in Table 6 were all squat cylinders weighing about 0.5kg. Shock wave energy was calculated from diaphragm gages at a distance of about 1m and facing the side of the charge. The precision of the measurements are ± 0.03 for W_{Dd} and ± 0.05 for RBE

If measurements of bubble period and bubble radius are available for an expl of known weight fired at a known depth, one can obtain its coefficients K and J (see section V). The ratios *cubed*

of these K's and J's to those of a reference expl can then be used to get RBE and RPBE (see Section I)

Coefficients K and J for several commonly used underwater expls are given in Table 7 (from Ref 17)

On occasion it can be important to know at what phase of its oscillations a bubble reaches the water surface and vents. Table 8 (from Ref 17) shows this in terms of reduced charge depth for large (140-900kg) TNT charges positioned far from the bottom

Data on the effect of expl *packing density*, ρ_0 , on shock and bubble parameters are scarce. According to Khristoforov (Ref 2), for PETN, P at $\rho_0 = 1.6\text{g/cm}^3$ is appreciably greater than P at $\rho_0 = 0.4\text{g/cm}^3$ at small values of $R/W^{1/3}$, and less so when $R/W^{1/3} \geq 10\text{m/kg}^{1/3}$. For Pb Azide, P at 1.6g/cm^3 is appreciably larger than P at 0.85g/cc over the entire range $0.2 \leq R/W^{1/3} \leq$

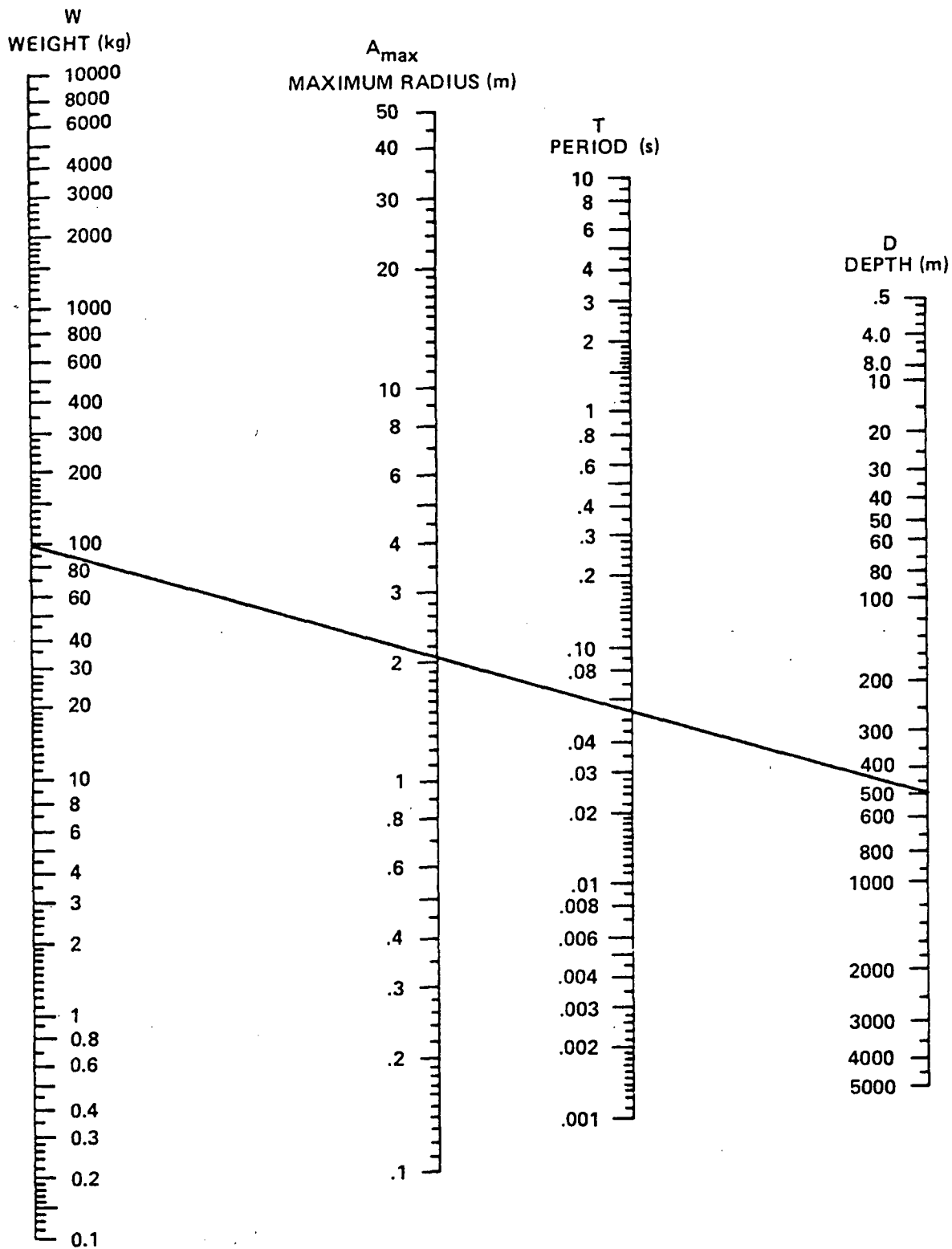

Fig 9 First Period and Maximum Radius of an Underwater Gas Bubble (TNT)

Table 5
Shock Wave and Bubble Conversion Factors

Explosive	Equal Weight Ratio				Equal Weight Ratio				$(RBE)_{TNT}$	$(RPBE)_{TNT}$
	D_{Wd} (Relative to HBX-1)				D_{Wd} (Relative to TNT)					
	P_m	θ	I	E	P_m	θ	I	E		
HBX-1	1.00	1.00	1.00	1.00	1.08	0.99	1.12	1.26	1.48	1.44
TNT	0.92	1.01	0.90	0.79	1.00	1.00	1.00	1.00	1.00	1.00
HBX-3	0.89	1.10	0.99	0.86	0.96	1.08	1.10	1.08	1.93	1.82
H-6	1.04	1.06	1.02	1.09	1.13	1.05	1.14	1.37	1.69	1.59
Pentolite	1.00	1.01	0.89	0.87	1.08	1.00	1.00	1.09	1.00	1.02

Table 7
Bubble Parameters for Various High Explosives

Explosive	J	K
TNT	3.50	2.11
Pentolite	3.52	2.11
HBX-1	3.95	2.41
HBX-3	4.27	2.63
H-6	4.09	2.52

Table 6
Underwater Shock Wave and
Bubble Energy Equivalent Weight Ratios for
Underwater Explosives

Material	Shock Wave $(W_{Dd})_{pent}$	Bubble $(RBE)_{pent}$
HMX	1.11	1.06
RDX	1.10	1.02
TNT	0.84	0.94
PETN	1.15	1.13
Tetryl	1.00	0.98
TNETB	1.18	1.16
H-6	1.18	1.54
HBX-1	1.13	1.47
HBX-3	1.00	1.95
Pentolite	1.00	1.00

Note: Based on small charges of weight about 0.5kg

Caveat: These parameters may be influenced by charge density

Table 8
Number of Bubble Oscillations Before
Bubble Reaches Surface (for a TNT Bubble)

Reduced Charge Depth $_{d/w}^{1/3}$ (m/kg $^{1/3}$)	Number of Bubble Oscillations Before Reaching Surface
0	0
0.5	0.37
1.0	0.72
1.5	1.08
2.0	1.45
2.5	1.83
3.0	2.22
3.5	2.65
4.0	3.07
4.5	3.55
5.0	4.07
5.5	4.68
6.0	5.37

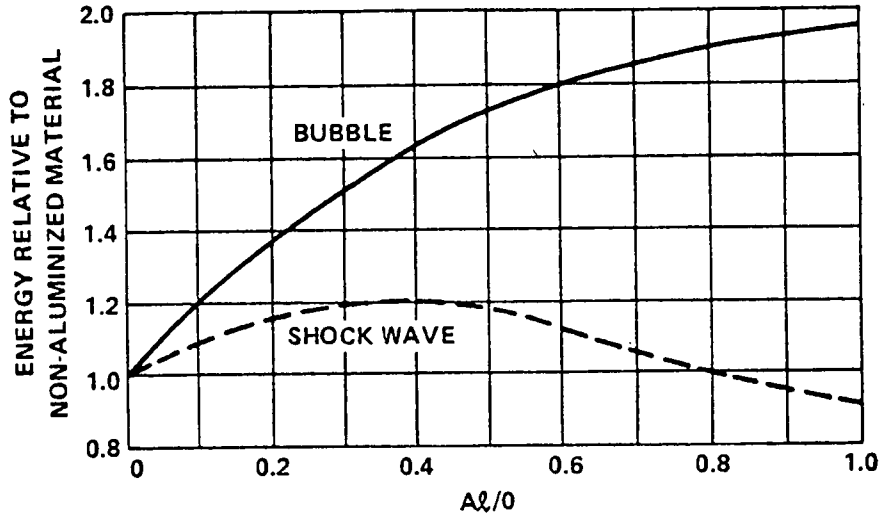

Fig 10 The Effect of Aluminum on the Underwater Power of Explosive Mixtures

Table 9
The Effect of Charge Density on the Underwater Performance of Two Explosives

% TMD	HBX-1		55/40/5 TNT/Al/Wax	
	$(W_{Dd})_{pent}$	$(RBE)_{pent}$	$(W_{Dd})_{pent}$	$(RBE)_{pent}$
85	1.15	1.49	0.71	1.72
86	1.15	1.49	0.71	1.70
87	1.15	1.48	0.71	1.68
88	1.15	1.48	0.71	1.64
89	1.15	1.48	0.71	1.60
90	1.15	1.47	0.70	1.55
91	1.15	1.47	0.68	1.47
92	1.15	1.47	0.66	1.39
93	1.15	1.46	0.63	1.27
94	1.15	1.46	0.60	1.11
95	1.13	1.45	0.55	0.90
96	1.11	1.44	0.50	0.67
97	1.07	1.43	—	—
98	1.01	1.40	—	—

$10m/kg^{1/3}$. However, the converse is claimed for impulse, with I being larger at small ρ_0 over the observed $R/W^{1/3}$ range for both PETN and Pb Azide. This is to be expected because θ increases strongly as ρ_0 decreases. Khristoforov's results also indicate that both T and A_{max} increase as ρ_0 decreases for PETN as well as for Pb Azide

Addition of *aluminum* enhances most underwater expln effects. In conventional CHNO expls, Al reacts to form Al_2O_3 with the liberation of a large amount of heat. This reaction is relatively slow and is rarely complete during the detonation regime in aluminized expls fired in air or under moderate confinement. In *free water*, however, sufficient confinement is available to enable the reaction to occur before appreciable expansion of the other detonation products. The enhancement of expln effects by Al can be estimated from the curves shown in Fig 10 (from Ref 17). The abscissa of Fig 10 is the gram atom Al/O ratio of the expl compn

Aluminized expls exhibit a decrease in performance as their packing density approaches theoretical maximum density (TMD). This effect is more pronounced in compns of high Al content. Table 9 (from Ref 17) shows equivalent weight ratios (W_{Dd}) and relative bubble energies (RBE) of two aluminized expls as a function of % TMD

In the preceding paragraphs we presented available shock and bubble data at distances relatively far from the detonating underwater charge. Hantel and Davis (Ref 9) obtained velocity and shock pressure data right up to the expl/water interface. We quote their summary: "Calibration data are presented for the shock

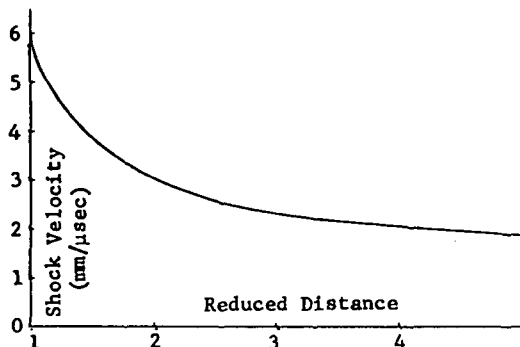

Fig 11 Shock Velocity vs Reduced Distance. Calculated from Fit to All Six Spheres

wave in water driven by a centrally-initiated sphere of explosive. The measured quantity is the shock position as a function of time; a simple function is fit by a least-square technique to the data. The derivative of the fit function gives shock velocity, which is used with the known shock Hugoniot function for water to get shock pressure. The useful range of pressure in the water is from 150 to 5 kbar, with an uncertainty less than $\pm 5\%$. For spheres of 3", 4½", and 6" diameter, no departure from simple scaling is found. The calibrated system is intended as a generator of a reproducible pressure pulse for use in explosive sensitivity tests, gauge calibration, etc."

Their shock velocity and shock pressure curves are shown in Figs 11 & 12, in which the "reduced distance" is $(R + r)/r$, where r is the radius of the spherical charge

As already stated (Section IV), modern values of impulse and energy are obtained by integration over a time of 5θ (Ref 17), and not the 6.7θ interval used by Cole (Ref 1). Occasionally it is desired to estimate the impulse and energy delivered in a shorter or longer time interval than 5θ . This can be done with the aid of the data shown in Table 10 (from Ref 17). The data are claimed to be applicable to any "conventional high explosive" (Ref 17)

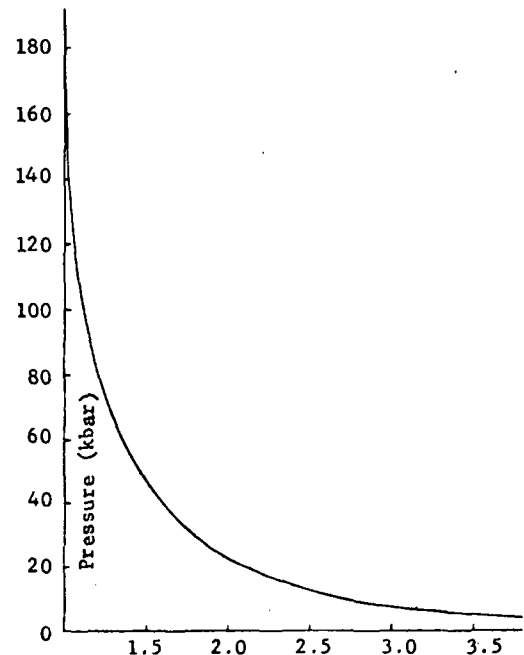

Fig 12 Pressure vs Reduced Distance. Calculated from Fit to All Six Spheres

Table 10
Shock Wave Impulse and Energy Ratios
vs Reduced Time

t/θ	$I/I_{5\theta}$	$E/E_{5\theta}$
0	0	0
0.2	0.120	0.250
0.4	0.230	0.415
0.6	0.320	0.540
0.8	0.400	0.650
1.0	0.465	0.725
1.2	0.525	0.783
1.4	0.575	0.825
1.6	0.620	0.855
1.8	0.660	0.880
2.0	0.690	0.900
2.2	0.720	0.915
2.4	0.750	0.925
2.6	0.775	0.935
2.8	0.800	0.945
3.0	0.825	0.950
3.2	0.845	0.960
3.4	0.865	0.965
3.6	0.885	0.970
3.8	0.900	0.975
4.0	0.920	0.980
4.2	0.935	0.983
4.4	0.955	0.987
4.6	0.970	0.990
4.8	0.980	0.995
5.0	1.000	1.000
5.2	1.010	1.002
5.4	1.020	1.004
5.6	1.035	1.006
5.8	1.045	1.008
6.0	1.060	1.010
6.2	1.070	1.012
6.4	1.080	1.014
6.6	1.095	1.016
6.8	1.105	1.018

Heretofore we have confined our discussion to spherical charges and briefly to squat cylindrical charges. For the former, gage orientation is unimportant if the spheres are centrally initiated since the disturbance will propagate outward thru the water with spherical symmetry. For

long cylindrical charges, however, at least close to the charge, the shock front will have the shape shown in Fig 13 (from Ref 1). It is to be expected that gages located at A, B and C, all at equal distance r_0 from the charge, can register different shock effects

A quantitative verification of this expectation is provided in Fig 14 (from Ref 1) which shows that off-the-side peak pressure is considerably larger than off-the-end pressure

VII. Theoretical Considerations

Theoretical aspects of underwater explns were studied intensively during WWII. The prominent names associated with these studies are: Kirkwood, Bethe, Brinkley, Penney and Dasgupta. Most of their efforts were summarized in presently hard-to-find NDRC reports. Fortunately Cole (Ref 1, Chaps 2, 4 & 8) provides an excellent detailed overview of their work. In this section we will follow Cole's presentation very closely. A less detailed summary of the theoretical studies is given in Chapt 13 of Ref 10

The fundamental approach used was that of *hydrodynamics* to obtain solutions of equations for the conservation of mass, momentum and energy. It is convenient to express these equations in vector notation and to consider small amplitude waves separately from waves of finite amplitude. In what follows, we will first discuss the *shock effects* of underwater explns and then proceed to a quantitative description of *gas bubble motion*

For *small amplitude* waves it is assumed that the density ρ after passage of the wave equals the initial density ρ_0 , and that any terms containing the particle velocity u can be neglected. With these assumptions, the conservation equations for momentum and mass become:

$$\frac{\partial v}{\partial t} = -\frac{1}{\rho_0} \text{grad } P \quad (1)$$

$$\frac{\partial \rho}{\partial t} = -\rho_0 \text{div } v \quad (2)$$

where v is the velocity vector. Since P is a definite function of density, we may write:

$$\frac{\partial P}{\partial t} = \left(\frac{dP}{d\rho} \right)_{s_0} \frac{\partial \rho}{\partial t} \quad (3)$$

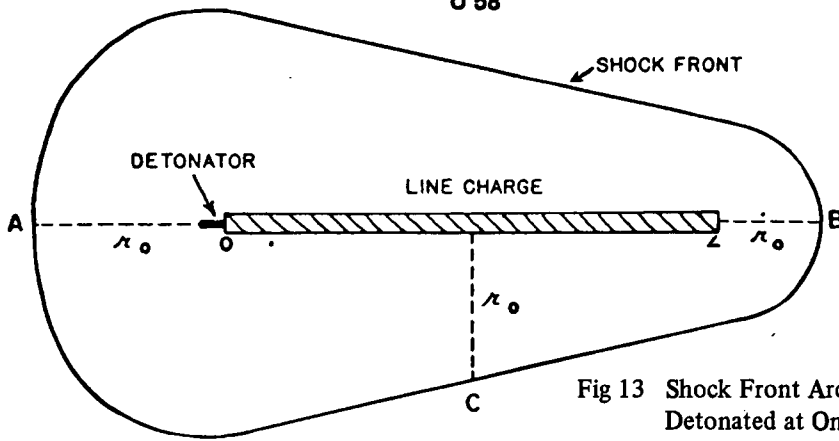

Fig 13 Shock Front Around a Line Charge Detonated at One End

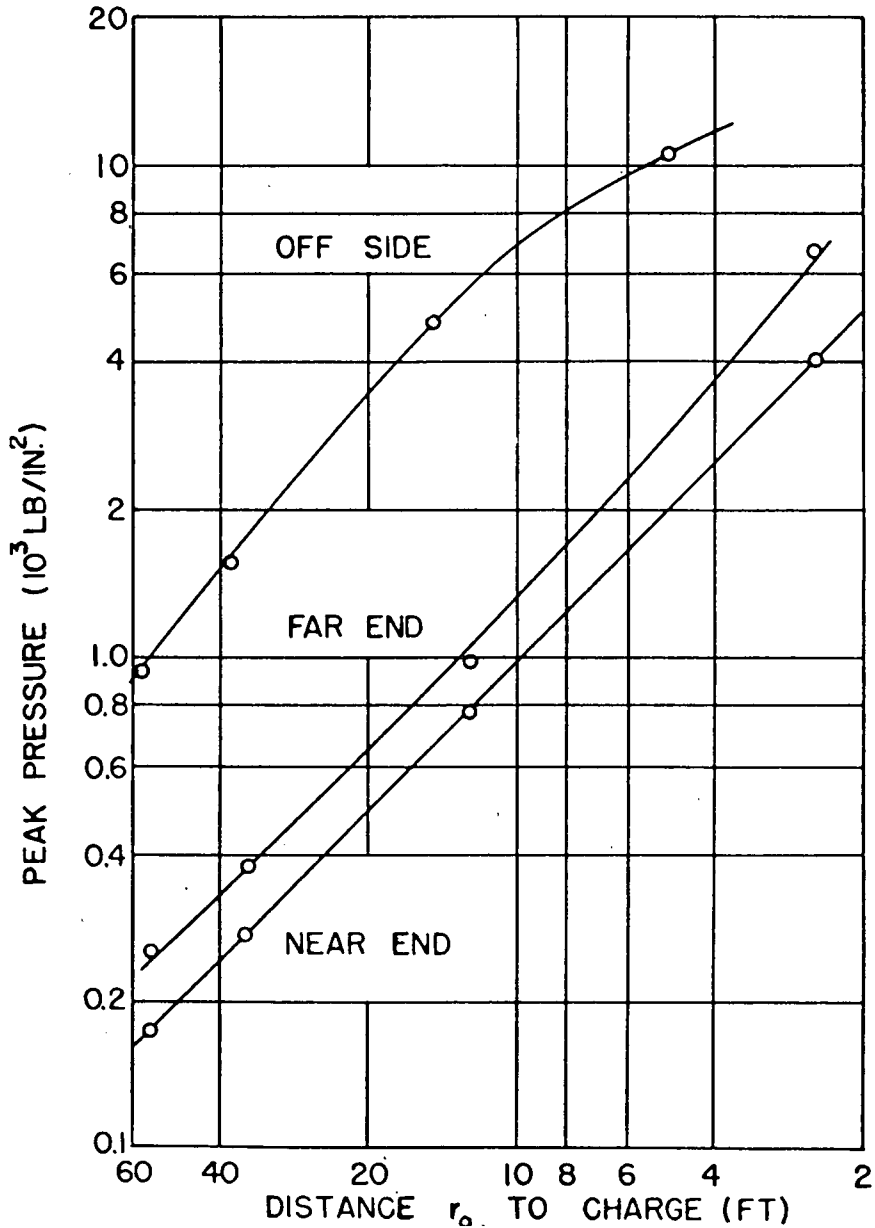

Fig 14 Peak Pressures for Line Charges (50-Pound TNT, 25 Foot Length) as a Function of Distance r_0 from the Nearest Point of the Charge

the subscript S_0 indicating changes along the isentrope having the entropy of the undisturbed fluid. The total differential $dP/d\rho$, understood to be evaluated for an isentropic change, will be denoted by c_0^2 , which is the square of the local sound velocity. Substitution of Eq (3) into (1) and (2) gives:

$$\frac{\partial v}{\partial t} = -\frac{1}{\rho_0} \text{grad } P \quad (4)$$

$$\frac{1}{c_0^2} \frac{\partial P}{\partial t} = -\rho_0 \text{div } v \quad (5)$$

For a *plane wave*, motion occurs only in the x direction and eqs (4) and (5) then become

$$\frac{\partial u}{\partial t} = -\frac{1}{\rho_0} \frac{\partial P}{\partial x}, \quad \frac{1}{c_0^2} \frac{\partial P}{\partial t} = -\rho_0 \frac{\partial u}{\partial x} \quad (6)$$

Furthermore, according to Cole (Ref 1), solving for P by differentiation and elimination, we obtain

$$\frac{\partial^2 P}{\partial x^2} = \frac{1}{c_0^2} \frac{\partial^2 P}{\partial t^2}$$

together with a similar equation for u

This one-dimensional form of the wave equation is satisfied by any function of the form $f(\pm x/c_0)$, the double sign choice accounting for waves advancing in either positive or negative directions

Physically, these solutions mean that any disturbance originated at some value of x travels unchanged in form with a velocity $c_0 = \sqrt{dP/d\rho}$. The particle velocity u corresponding the the pressure $P = f(t-x/c_0)$ may be found from the first of Eq (6):

$$\frac{\partial u}{\partial t} = -\frac{1}{\rho_0} \frac{\partial P}{\partial x} = \frac{1}{\rho_0 c_0} f' \left(t - \frac{x}{c_0} \right)$$

the prime indicating differentiation with respect to the argument. Integrating, we have

$$\begin{aligned} u - u_0 &= \frac{1}{\rho_0 c_0} \int_{t_0}^t f' \left(t - \frac{x}{c_0} \right) dt \\ &= \frac{P - P_0}{\rho_0 c_0} \end{aligned}$$

If the constants of integration are chosen to make $u = 0$ when $P = P_0$, the pressure in the undisturbed fluid, we have

$$u = \frac{P - P_0}{\rho_0 c_0} \quad (7)$$

Eq (7) is one of the fundamental relationships of hydrodynamics

The simplest form of spherical wave is one in which the disturbance is a function of radial distance from a source and not of the angular position. If the radial component of particle velocity is u_r , other components being zero, and $P = P(r)$, Eqs (4) & (5) become

$$\frac{\partial u_r}{\partial t} = -\frac{1}{\rho_0} \frac{\partial P}{\partial r}$$

$$\frac{1}{c_0^2} \frac{\partial P}{\partial t} = -\rho_0 \frac{1}{r^2} \frac{\partial}{\partial r} \left(r^2 \frac{\partial u_r}{\partial r} \right)$$

If the second equation is differentiated with respect to t , and the particle velocity eliminated by the first equation, we obtain

$$\frac{1}{r^2} \frac{\partial}{\partial r} \left(r^2 \frac{\partial P}{\partial r} \right) = \frac{1}{c_0^2} \frac{\partial^2 P}{\partial t^2}$$

It is easily verified that any function of the form $P(r,t) - P_0 = (1/r)f(t-r/c_0)$ is a solution, the negative sign corresponding to an outgoing wave about the center. Thus the form of an *infinitesimal spherical wave* does not change as it spreads out at the same velocity, but its amplitude decreases proportional to $1/r$, the inverse of the radial distance

From the above eqns it can be shown (Ref 1, Chapt 2) that the radial component of particle velocity u_r is given by:

$$u_r(t) - u_r(t_0) = \frac{P - P_0}{\rho_0 c_0} + \frac{1}{\rho_0 r} \int_{t_0}^t [P(r,t') - P_0] dt'$$

Then, according to Cole, "If the time $t_0=0$ is chosen to precede any disturbance, it is seen that the velocity in the fluid at a later time is a function, not only of the pressure at that time but of all the previous changes in pressure after a disturbance first reaches the point. These changes are such that, in a radial disturbance, the water will be left with an outward velocity, or *afterflow*, following passage of a positive pressure wave. This afterflow remains, even though the pressure has returned to its equilibrium value, and will be brought to zero only after the pressure falls below the equilibrium value.

A complete evaluation of the pressures and

flow velocities behind the front of an advancing pressure wave clearly can be made only by considering the properties of the spherical source, or agency by which the pressure wave is generated. The conditions at the front, no matter how far it progresses, are determined in the acoustic approximation by the initial motion of the source. The conditions behind the front, however, depend on the later behavior of the source, and any physically realizable source must in turn be affected by the motion of the fluid surrounding it.

To clarify the nature of the afterflow term, it is appropriate for underwater explosions to consider the source as a spherical boundary in the fluid containing gas initially at high pressure. The initial pressure in the pressure wave is determined by the initial gas pressure. This initial compression leaves behind it outward flowing water in an increasingly large sphere. If the compression is to be maintained in this volume, increasingly large displacements of water near the source are necessary, despite the weakening of the initial pressure at the front by spherical divergence. The pressure in the gas sphere, however, decreases as the volume determined by the spherical boundary increases, and the strength of this source must decrease. Outward accelerations of the water near the boundary will thus decrease, but as long as there is a pressure excess over hydrostatic, outward flow continues.

In the later stages of the motion, the pressure in the gas sphere and surrounding fluid falls below the hydrostatic value P_0 , the outward flow is brought to rest, and then inward flow begins. The kinetic energy of this motion is thus returned to compression of the gas sphere, rather than being radiated to infinity as a wave of compression. At points behind the shock front, for which the pressures are large and rapidly changing, the particle velocity depends

on both the past history of the pressure and its value at the time, and a clear cut distinction between motion resulting directly from compression and noncompressive flow cannot be made in this region."

In describing small amplitude waves it was assumed that $\rho = \rho_0$ with the consequence that these disturbances always propagate at a velocity c_0 and can no longer be a constant. These finite amplitude waves can and will be transformed into very steep-fronted supersonic *shock waves* as illustrated in the following example quoted from Cole: "In order to see what effect this has on wave propagation, suppose that, as a result of displacements of a piston in a tube, a plane wave of pressure is advancing from left to right in the tube, and at some instant in time has the form shown in Fig. 2.1(a). Compression started in the positive direction at point a will appear to travel with a speed c_a relative to the fluid at the point. If the particle velocity in the fluid is u_a , the speed with respect to the walls will be $c_a + u_a$. Similarly, a compression at point b will travel with a speed $c_b + u_b$ relative to the fixed wall. If the pressure set up in the fluid by the main wave is greater at b than at a, the speed of sound c and the particle velocity u will both be greater at b, and the disturbance at b will advance faster than that at a. At a later time, therefore, we have to expect that regions of higher pressure in the wave will approach those of lower pressure ahead of it, as shown in Fig. 2.1(b), the effect increasing as the pressure differences increase. The ultimate result of this overtaking effect will be to make the front of the wave very steep as shown in Fig. 2.1(c). As the condition of infinite steepness is approached, however, the pressure and temperature of closely adjacent layers will be very different; in other words, the gradients will be large."

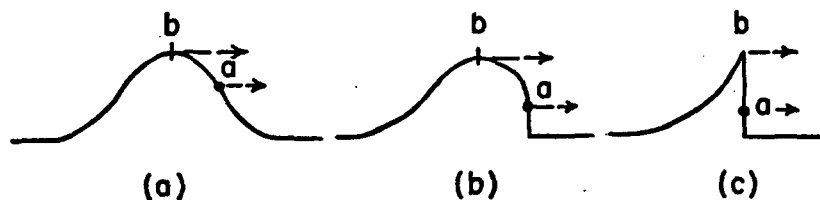

Fig. 2.1 Formation of a Shock Front in a Plane Wave of Finite Amplitude

Again, according to Cole: "Although the arguments just given apply to plane waves, we should expect the same sort of effect in spherical waves except that the amplitude will be weakened by the spreading out of the wave, and the effect will become less important as the distance from the source increases. It would be erroneous, however, to conclude that effects of finite amplitude at a shock front are important only within a few feet of an explosion."

By substituting the Riemann integral

$$\sigma = \int_{\rho_0}^{\rho} c(\rho) \frac{d\rho}{\rho}$$

into the mass and momentum conservation eqns for a finite amplitude *plane wave*, one obtains (after minor manipulation):

$$\frac{\partial}{\partial t} (\sigma + u) + (c + u) \frac{\partial}{\partial x} (\sigma + u) = 0$$

$$\frac{\partial}{\partial t} (\sigma - u) - (c - u) \frac{\partial}{\partial x} (\sigma - u) = 0$$

Similarly for finite *spherical waves* one gets:

$$\frac{\partial}{\partial t} (\sigma + u) + (c + u) \frac{\partial}{\partial r} (\sigma + u) = -\frac{2cu}{r}$$

$$\frac{\partial}{\partial t} (\sigma - u) - (c - u) \frac{\partial}{\partial r} (\sigma - u) = -\frac{2cu}{r}$$

In both sets of the above eqns, u is the particle velocity and $c \neq c_0$ but is a function of P and ρ . For spherical waves and sufficiently small increments dt we can define:

$$N = (\sigma + u)/2, Q = (\sigma - u)/2 \quad \text{and}$$

$$dN = \frac{\partial N}{\partial t} dt + \frac{\partial N}{\partial r} dr, \text{ which, as shown by}$$

Cole, leads to:

$$dN = -\frac{cu}{r} dt, \quad dr = (c+u)dt \quad (8)$$

$$dQ = -\frac{cu}{r} dt, \quad dr = -(c-u)dt \quad (9)$$

"If at a time t , values of c , u , and σ are known as a function of r , increments in N , Q may be calculated for a sufficiently small interval dt and corresponding values of dr . Carrying out this process gives new values of N and Q at distances $r+dr$ and time $t+dt$. From these new values of N and Q as a function of r , at time $t+dt$, c and u

can be determined if σ is known from the equation of state for the fluid and the process can be repeated."

The above iterative method provides a means of estimating shock effects of spherical underwater charges, but the method is cumbersome and the approximations involved (particularly the neglect of dissipation effects) are not completely justifiable

A more tractable approach to shock wave propagation in water is that of Kirkwood and co-workers. For details of this rather involved analysis, the reader is referred to Ref 1, pp 29-33 and 104-106. The basic assumptions of this theory are that behind the shock front the entropy is constant, ie, $ds=0$, and that the conversion of the expl to its products occurs at constant volume. With these assumptions, it is then possible to get approximate *analytical* solutions of the equation of motion in terms of the enthalpy of the system

We will now summarize the conclusion of the Kirkwood-Bethe theory. Fig 15 shows the computed peak pressure and computed reduced time constant for TNT plotted vs the inverse reduced distance. The dotted lines are a power function fit thru the computed peak pressures. The x's are drawn in by the writer to compare computed and measured reduced time constants (taken from Fig 7.9, p 240 of Ref 1). Comparison of other computed and measured shock parameters on the basis of the power functions shown below (in Cole's notation and in English units) is made in Table 11 (from p 242 of Ref 1)

Note that theory predicts all *spherical* shock parameters to be a little higher than observed, but the overall agreement is remarkably good. Incidentally the above eqns with their best fit coefficients (shown in Table 11) hold for pressures up to about 25,000psi or roughly to a distance of 7 charge diameters. At closer distances theory begins to break down because of neglect of dissipation effects at the shock front, and disregard of the true form of the detonation wave. Measured data in this region are scarce. What data are available indicate that pressure decays more rapidly with distance than predicted by theory or the power function relationship based on measurements at distances greater than 7 charge diameters

Table 11

Parameters of Shock Wave Similarity Curve for Several Explosives

Values predicted from the Kirkwood-Bethe theory over the same pressure range are given in parentheses

$$P_m = K \left(\frac{W^{1/3}}{R} \right)^\alpha$$

$$I(t/W^{1/3}) = IW^{1/3} \left(\frac{W^{1/3}}{R} \right)^\beta$$

$$E_f(t/W^{1/3}) = mW^{1/3} \left(\frac{W^{1/3}}{R} \right)^\gamma$$

Explosive	Peak Pressure P_m		Impulse $I(t)$		Energy Density $E(t)$		Time of Integration
	$10^{-4}k$	α	l	β	$10^{-3}m$	γ	
TNT Density 1.52	2.16 (2.60)	1.13 (1.21)	1.46 (1.50)	0.89 (0.86)	2.41 (3.78)	2.05 (2.11)	6.70
Loose Tetryl Density 0.93	2.14 (2.50)	1.15 (1.22)	1.73 (1.50)	0.98 (0.86)	3.00 (3.20)	2.10 (2.04)	5.00
Pentolite Density 1.60	2.25 (2.85)	1.13 (1.23)	2.18 (1.65)	1.05 (0.88)	3.27 (4.23)	2.12 (2.11)	6.70

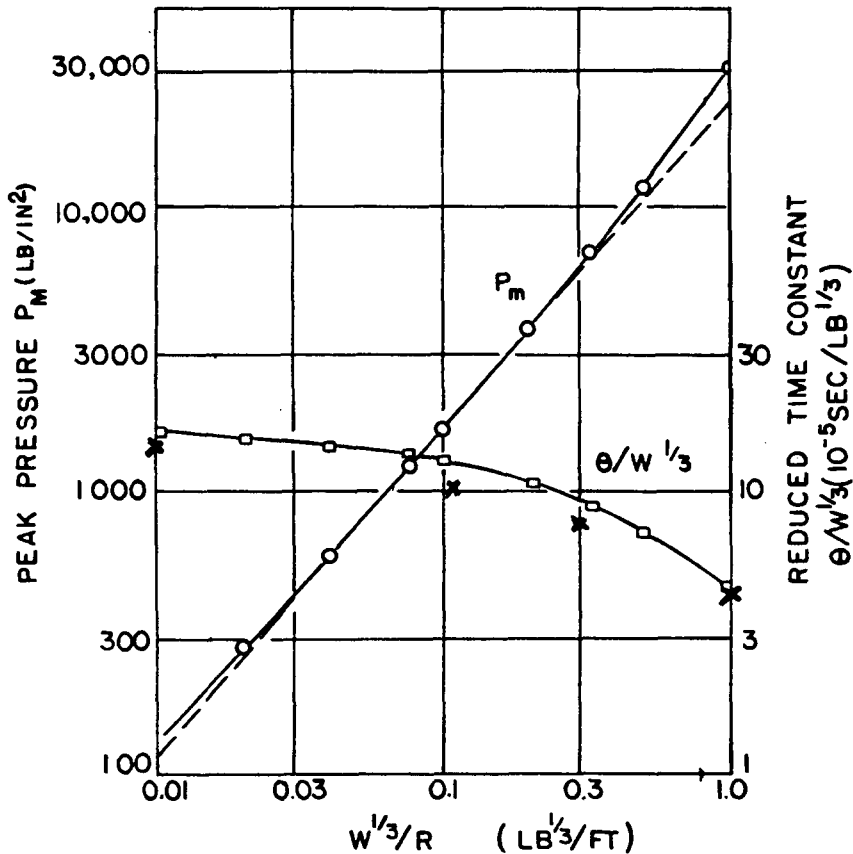

Fig 15 Calculated Peak Pressure and Time Constant for TNT (Kirkwood-Bethe theory)

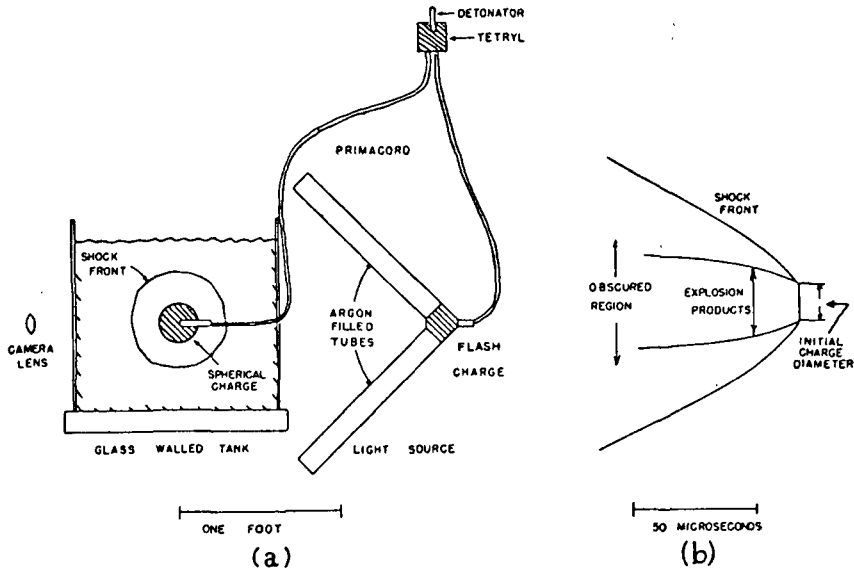

Fig 16 Shock Wave Velocity Measurements for Small Charges

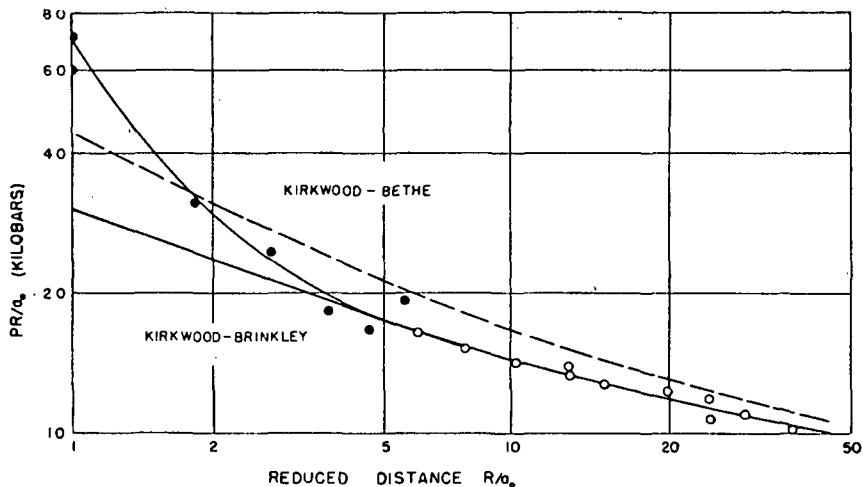

Fig 17 Shock Front Pressures from Velocity Data Compared with Theory and Piezoelectric Gauge Measurements (Ref 1)

If measurements of the shock velocity in water are available at various distances from the charge, one can compute shock pressures at these distances. This approach can be used close to the charge where direct transducer measurements present formidable problems. An exptl arrangement for measuring shock velocity is shown in Fig 16 (Ref 1). Measurements thus obtained are compared with theoretical predictions in Fig 17 (closed circles). Also shown are direct pressure measurements (open circles).

Agreement between measurements and the Kirkwood-Brinkley theory is excellent for reduced distances greater than 2 (a_0 =charge radius)

Very close to the charge, and particularly at the charge/water boundary, the theoretical calculations are much too low. This is not unexpected since theory assumes a constant volume expln, whereas a true detonation imparts roughly twice the pressure to the surrounding water than a constant volume expln

The theories of the shock wave so far described have dealt with the case of spherical symmetry, which is the simplest symmetry corresponding to an exptly realizable situation. Practical underwater charges are more cylindrical than spherical in shape, and they are mostly initiated at one end rather than in the center. Any tractable theory for some other than spherical shape of charge is therefore desirable, if only to reveal the nature of the resulting differences. The simplest geometry for this purpose is evidently the one-dimensional case of an infinite cylinder detonated simultaneously at all points on its axis, but this is obviously an exptly unattainable mathematical idealization. However, even for cylinders of finite length initiated at one end, the detonation velocity can be high enough so that the shock front makes an angle of less than 30° with the cylinder surface. Consequently it is to be expected that at distances rather close to the charge, a theory based on the ideal infinite cylinder may provide results that are in rough accord with observations

The basic differences between spherical and cylindrical symmetry are in the propagation equations for the water and expln products, the equations of state and the shock front conditions remaining unchanged. Thus, even for acoustic waves, pressure for cylindrical waves varies as $r^{-1/2} F(t-r/c_0)$ where F is an undetermined function, as compared with $r^{-1} F(t-r/c_0)$, valid at any distance for acoustic spherical waves. The development of a finite amplitude theory will not therefore be as simply related to the actual state of affairs, and errors incurred in approximations used will be larger than for spherical waves

Rice and Ginnell (see Ref 1, Chapt 4) developed a theory for shock effects of infinitely long cylinders along lines analogous to the Kirkwood-Bethe theory for spheres. As expected (on the basis of geometric considerations and known acoustic propagation), pressure decay with distance in cylindrical charges is much slower than for spheres. The following discussion, taken verbatim from Cole (Ref 1, Chapt 4), presents the major results of the Rice-Ginnell theory: "The calculated peak pressure P_m for cast TNT of density 1.59 is plotted in Fig. 18 as a function of R/a'_0 , where a'_0 is the radius of the cylinder and R the distance from the axis. Near

the charge the pressure falls off roughly as $(a'_0/R)^{0.6}$, and for greater values of R/a'_0 changes in slope of the logarithmically plotted curve occur. These changes at large values of R/a'_0 are, however, not likely to be realized in actual experiments because cylindrical charges of length many times the distance R , which itself is much greater than a'_0 , would be necessary to approximate the assumed symmetry.

As an estimate of peak pressure in the equatorial plane perpendicular to the axis of a charge of finite length, Rice and Ginnell suggest that comparison be made with a spherical charge of the same weight. At small distances, the peak pressure should be essentially that for an infinite cylinder, and at larger distances the pressure should approach values for the sphere, the deviations from this symmetry becoming increasingly unimportant.

The pressures for spherical charges of the same weight as cylinders with length/radius ratios of 10 and 50 are plotted in Fig. 18, as calculated from the Kirkwood-Bethe theory. The transitions from the cylindrical case to the spherical ones should occur in the region $R \approx L/2$, and the dotted lines suggest a reasonable transition. The decay of peak pressure with distance on this basis would change rather smoothly from a decay roughly as $(a'_0/R)^{0.6}$ near the charge to a decay as $(a'_0/R)^{1.15}$ at distances greater than the length of the charge. Similar estimates for the time constant θ as defined by $P(t) = P_m e^{-t/\theta}$ are plotted in Fig. 19, and the differences in the changes of θ/a_0 with increasing distance are evident from this figure."

To compare shock effects of *off-the-side* with *off-the-end* cylindrical charges, we show measured peak pressures and energies from 7.62kg, 7.62m long TNT cylinders of 0.05m diameter in Figs 20 & 21, respectively (from Ref 17)

Note the relatively small dependence of pressure or energy on direction of initiation in the off-the-end measurements and the large differences between the off-the-side and off-the-end measurements

The x's on Fig 20 (drawn in by the writer) are derived from the theoretical *infinite* cylinder results of Fig 16. It appears that the theoretically calculated points follow the shape of the observed curve rather well but are displaced

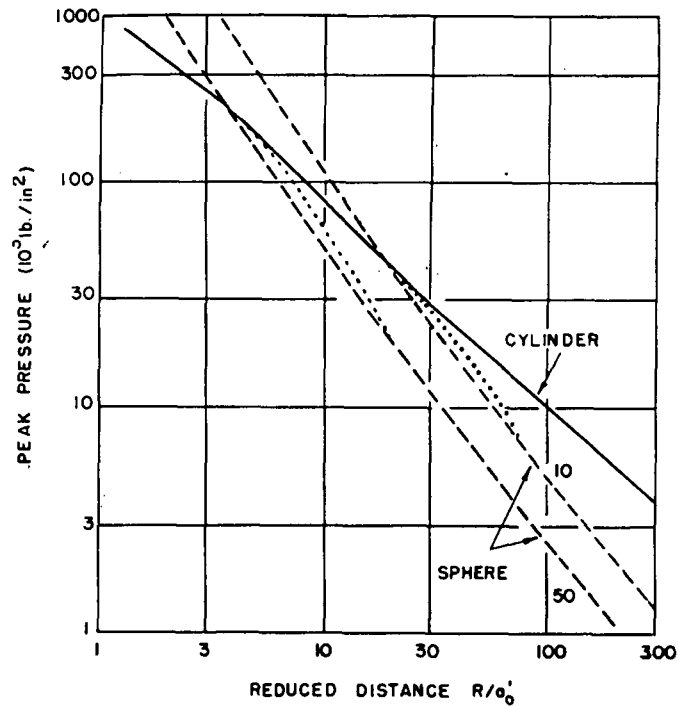

Fig 18 Calculated Peak Pressure at the Side of a Cylindrical TNT Charge. The dashed lines are for spherical charges and the dotted lines indicate transition to the dashed lines for charges of finite length

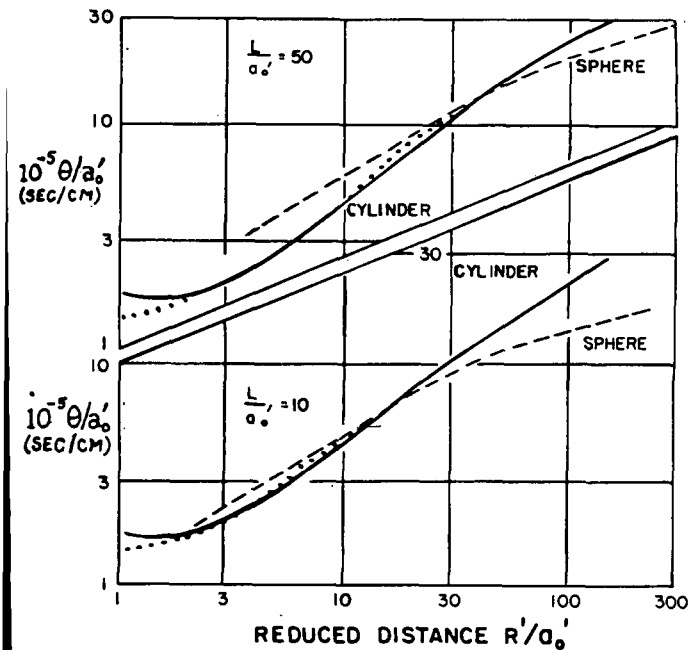

Fig 19 Calculated Time Constants at the Side of a Cylindrical TNT Charge. The dashed lines and dotted lines have the same significance as in Fig 18

above it as would be expected, because theory neglects dissipation effects at the shock front

Recently various computational *hydro codes* have been adapted to the determination of underwater shock parameters. A Lagrangian code (with artificial viscosity) augmented by a "sharp shock routine" was used by Sternberg & Hurwitz (Ref 12) to generate the curves shown in Figs 22, 23 & 24

Note that PBX 9404 has the highest shock pressure (Fig 22) at all reduced distances, but Pentolite has the highest energy (Fig 24) at $R/R_0=10$. The highest impulse (area under the P-t curves in Fig 23) is obtained with a low density Pentolite charge. The implications of these results will be examined more fully in the next section

So far we have been considering theoretical treatments of underwater shock effects. Now we turn our attention to a theoretical description of *bubble motion*

After emission of the shock wave, the gaseous products of an expln continue to expand outward at a gradually decreasing rate. As a result there are considerable radial displacements of the water, but the changes in velocity take place at a much slower rate than in the initial phases of the motion immediately following detonation. The pressures in the surrounding liquid are therefore much smaller and the whole character of the motion changes. As already stated in Sect I, bubble oscillations are relatively stable and during most of the oscillation cycle the pressure within the bubble is much less than the hydrostatic pressure.

These observations about the bubble motion are the basis of all the bubble theories which lead to numerical predictions of bubble radius, migration and period. It is a common characteristic of such theories that changes in density of the water surrounding the bubble are neglected (the noncompressive approximation), and it is further assumed that the bubble retains a spherical form thruout its motion. From what has been said, it is evident that both these assumptions are plausible as far as the expanded phase of the motion is concerned. They must, however, be increasingly poor as the bubble approaches its minimum radius for which very much larger pressures and acceleration are involved

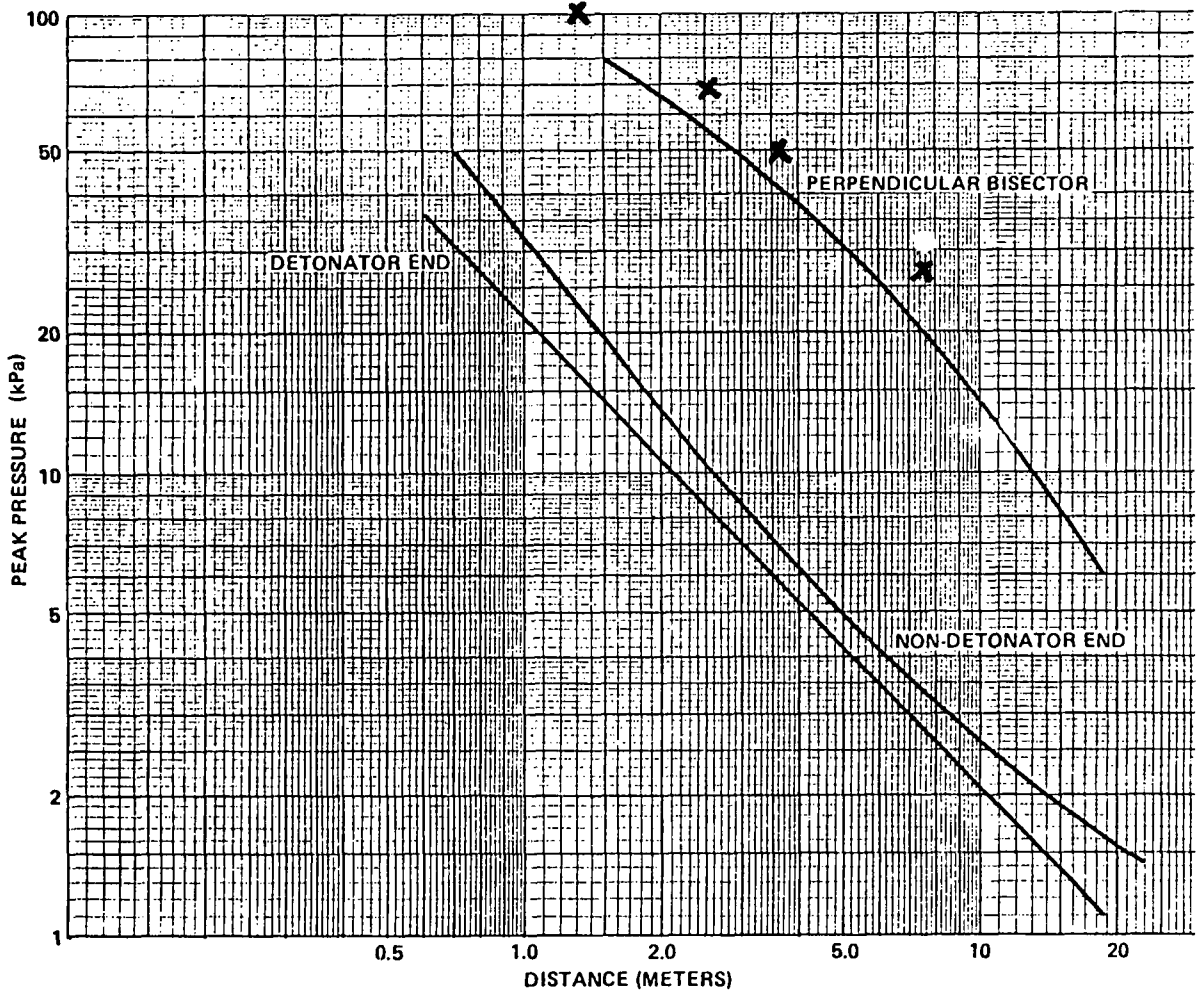

Fig 20 Peak Pressures Produced by Line Charges

Most of the features of the theoretical treatment of bubble motion are present in the treatment that considers the water incompressible and neglects gravity effects. We quote from Cole (Ref 1, Chapt 8): "The simplest approximation to the true motion of the gas bubble is the one in which it is assumed that the motion of the surrounding water is entirely radial and there is no vertical migration. In this approximation, which has been discussed by a number of writers, the hydrostatic buoyance resulting from differences in hydrostatic pressure at different depths is neglected. It is thus assumed that at an infinite distance from the bubble in any direction the pressure has the same value as the initial hydrostatic pressure P_0 at the depth of the charge

(atmospheric plus the added pressure of the water column). For a given depth of charge, the differences in pressure at the surface or near the bubble will clearly be greater the larger the charge and bubble resulting from its deformation. The neglect of differences in hydrostatic pressure should thus be more serious for large charges and small depths.

If radial flow is assumed, the equations of continuity and motion for the water are (Eqs. (2.2) and 2.4))

$$(8.1) \quad \frac{\partial \rho}{\partial t} + u \frac{\partial \rho}{\partial r} + \rho \frac{\partial u}{\partial r} + \frac{2\rho u}{r} = 0$$

$$\rho \frac{\partial u}{\partial t} + \rho u \frac{\partial u}{\partial r} + \frac{\partial P}{\partial r} = 0$$

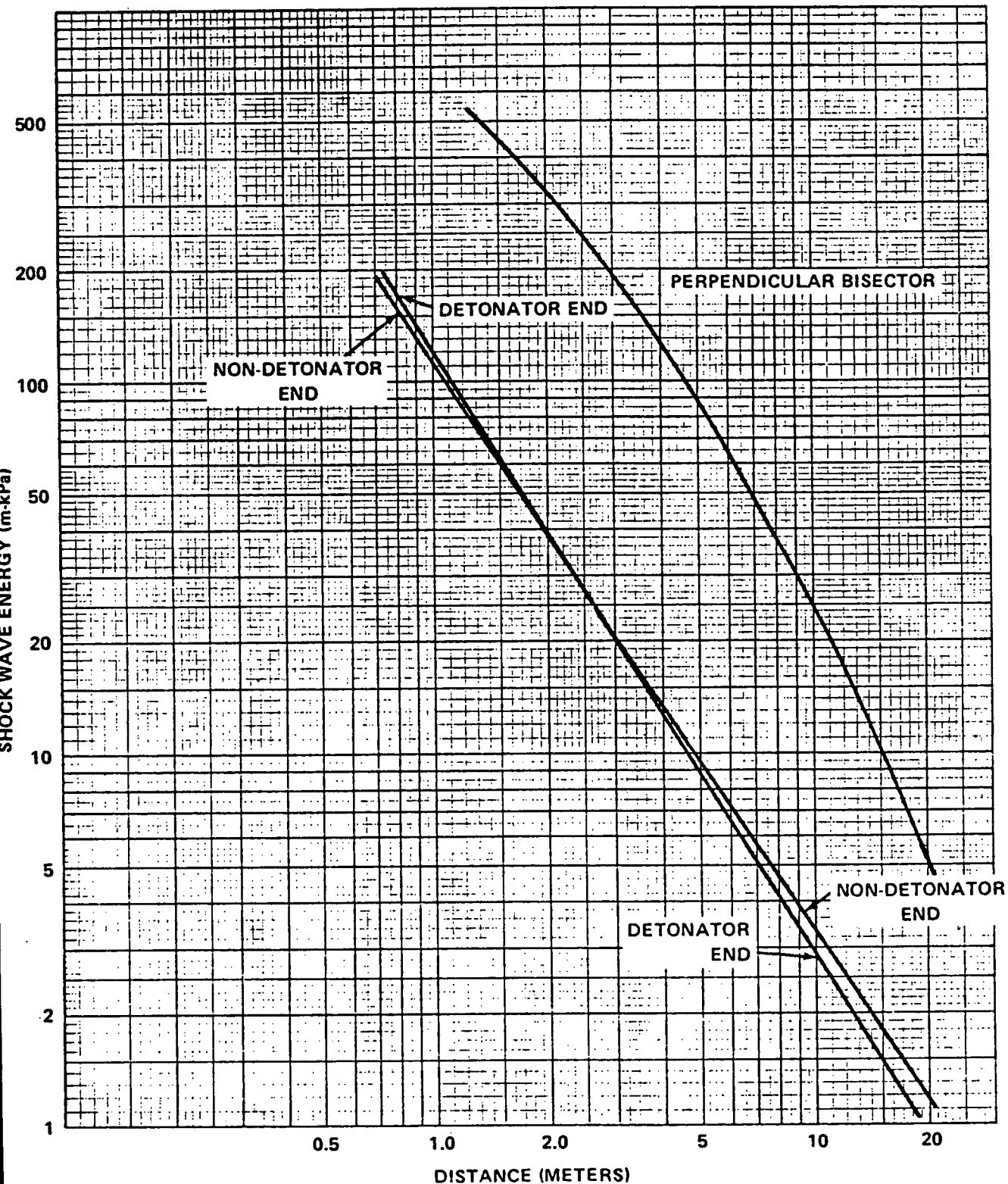

Fig 21 Shock Wave Energies Produced by Line Charges

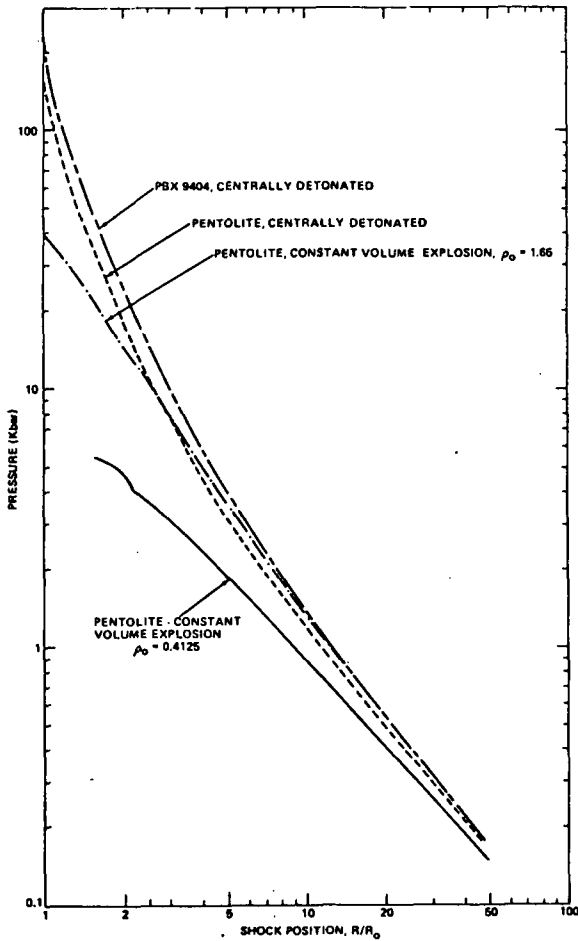

Fig 22 Calculated Peak Shock Pressure vs Distance for Explosions in Water

For pressure changes of the order 15 lb/in², such as prevail over most of the bubble motion, the corresponding changes in density are of the order 10⁻⁴ρ₀, where ρ₀ is the equilibrium density. Under these conditions, the derivatives of density ρ are easily seen to be negligible in the first of Eqs (8.1), which then becomes

$$\frac{\partial u}{\partial r} = -\frac{2\rho u}{r}$$

Integrating this equation, we have

$$u(r,t) = \frac{u_1(t)}{r^2}$$

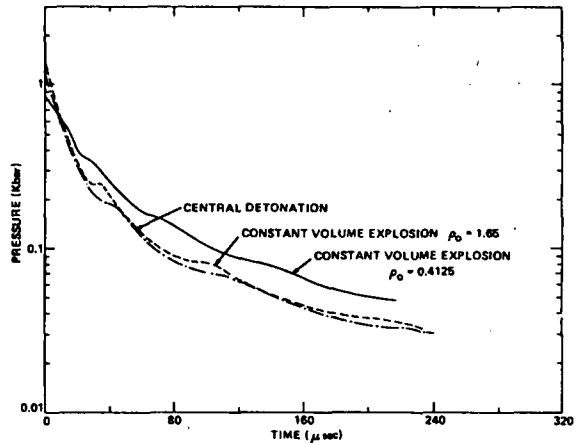

Fig 23 Calculated Pressure vs Time at 10 Charge Radii, for Pentolite Explosions in Water

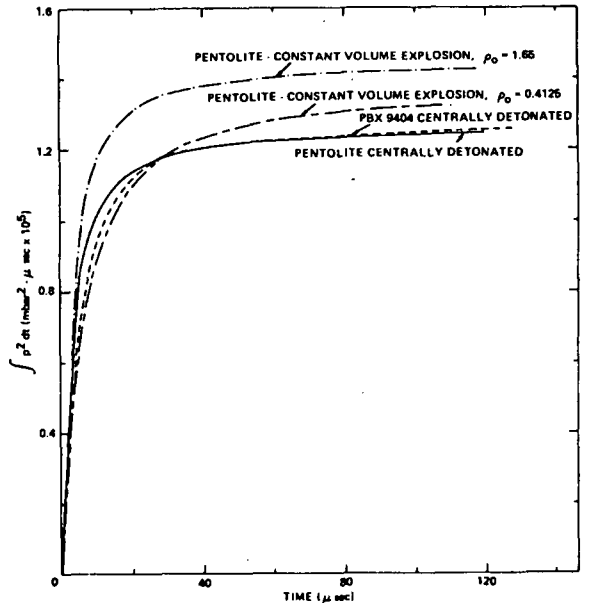

Fig 24 Calculated Integral of p²dt vs Time at 10 Charge Radii, for Explosions in Water

where the constant of integration u₁(t) is the velocity for r=1 and may depend on time. The radial velocity in noncompressive flow thus falls off as the inverse square of the distance from the origin, as is, of course evident from elementary principles. With this result the second of Eqs (8.1) becomes

$$(8.3) \quad \frac{1}{r^2} \rho_0 \frac{du_1}{dt} + \frac{1}{2} \rho_0 \frac{\partial u^2}{\partial r} + \frac{\partial P}{\partial r} = 0$$

Integrating from the surface of the gas sphere, for which $r=a$, $u_a=da/dt=u_1 a^2$, $P=P_a$, to infinite distance where $P=P_0$ and $u=0$, gives

$$\frac{\rho_0}{a} \cdot \frac{d}{dt} \left(a^2 \frac{da}{dt} \right) - \frac{1}{2} \rho_0 \left(\frac{da}{dt} \right)^2 - (P_a - P_0) = 0$$

Integrating with respect to time leads to the result

$$(8.4) \quad \frac{1}{2} \rho_0 a^3 \left(\frac{da}{dt} \right)^2 + \frac{1}{3} P_0 a^3 - \int_0^t P_a a^2 da = C'$$

where C' is a constant of integration. Except for a factor 4π , the integral over a is easily seen to represent the work done by the pressure P in expanding the sphere to its radius $a(t)$, as the element of volume is $dV=4\pi a^2 da$, and the integral must therefore equal the decrease in internal energy of the gas to $E(a)$ from its initial value. Absorbing this initial value into a new constant of integration Y gives after rearrangement

$$(8.5) \quad \frac{3}{2} \left(\frac{4\pi}{3} \rho_0 a^3 \right) \left(\frac{da}{dt} \right)^2 + \frac{4\pi}{3} P_0 a^3 + E(a) = Y$$

Written in this form, it is easily seen that the first time integral of the equation of motion is merely the expression of conservation of energy as the first term is readily shown to be the kinetic energy of radial flow outside the boundary, and the second term is the work done against hydrostatic pressure

If the products of explosion behave as ideal gases with a constant ratio of specific heats γ and are further assumed to undergo adiabatic changes, the pressure-volume relation is $P(V/W)^\gamma = k$, where W is the mass of explosive products in grams and k is a constant. The internal energy $E(a)$ is then given by

$$E(a) = \int_{V(a)}^{\infty} PdV = \frac{P_a V(a)}{\gamma-1} = \frac{kW}{\gamma-1} \left(\frac{W}{V(a)} \right)^{\gamma-1}$$

From the last expression, it is evident that $E(a)$ decreases rapidly with increasing volume (proportional to a^3), and at sufficiently expanded stages of the motion represents a negligible fraction of the initial energy of the products."

Cole shows that for TNT the fraction F of the remaining energy Y which is present as internal energy at any state of expansion is

$$F = \frac{E(a)}{Y} = 0.166 P_a^{1/5} = 0.42 \left(\frac{W}{a^3} \right)^{1/4}$$

where P is in psi, W in lbs, and a in ft. An estimate is that it is less than 25% of the total energy over more than 70% of the oscillations. Thus at first approximation one can neglect internal energy

Then according to Eq 8.5 the max radius a_m obtains when $da/dt=0$ and

$$(8.6) \quad Y = \frac{4\pi}{3} P_0 a_m^3$$

This relation thus furnishes an experimental method for determining, to a rather good approximation, the total energy Y associated with the radial flow of water in terms of the maximum radius a_m of the bubble and the hydrostatic pressure P_0 at the depth of the expln

Neglecting the internal energy in Eq 8.5 makes possible separation of the variables, and using Eq 8.6 to eliminate Y leads to an expression for t which cannot be solved analytically. Numerical solutions with neglect of a_0 (initial radius) with respect to a_m gives the $\frac{1}{2}$ period of oscillation T as:

$$T = \frac{2}{3} a_m \left(\frac{3\rho_0}{2P_0} \right)^{1/2} B_1 \left(\frac{5}{6}, \frac{1}{2} \right) = 1.83 a_m \left(\frac{\rho_0}{P_0} \right)^{1/2}$$

and in terms of the total energy Y , one obtains the so-called *Willis formula*

$$T = 1.14 \rho_0^{1/2} \frac{Y^{1/3}}{P_0^{5/6}}$$

In spite of the various approximations used in obtaining the above expression, the Willis formula in the form of:

$$T = \frac{KW^{1/3}}{(H+H_0)^{5/6}}$$

gives an accurate representation of measured bubble periods in free water (see Sect VI). A further check on the above theory is provided in Fig 24a, where measured bubble radii are compared with computed radii

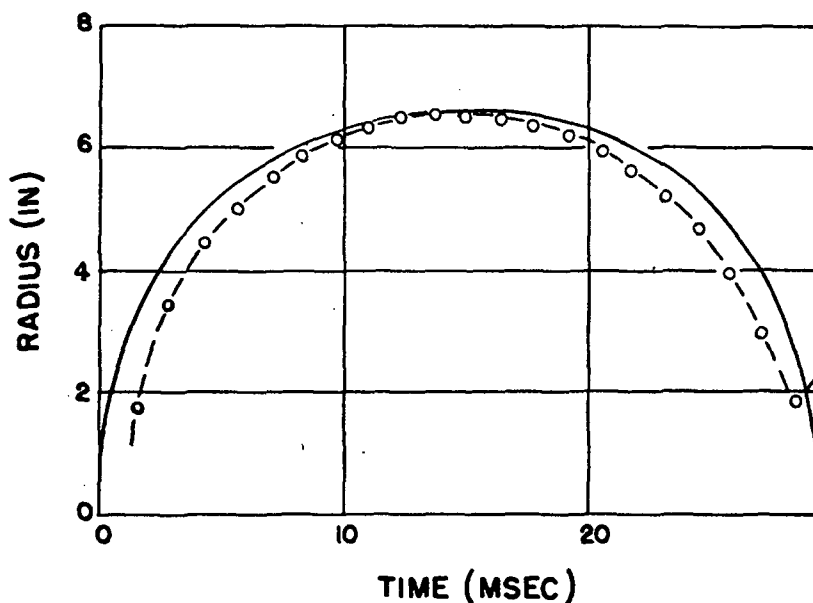

Fig 24a Measured and Calculated Radius of the Gas Sphere from a Detonator One Foot Below the Surface

VIII. Energy Partition and Useful Work of Underwater Explosions

From a practical point of view, it is important to determine how the chemical energy of an underwater expln is partitioned at various distances from the charge and how much useful work can be realized from such an expln. The pioneer efforts to answer these questions are summarized by Cole (Ref 1, Chaps 4 & 8). In Table 12, computed and measured TNT *shock wave energies* are compared. Also included are "measured" *afterflow energies*. Unfortunately there are no measured data close to the charge, but computations indicate shock wave energy is dissipated rapidly within about 5 charge radii and more slowly thereafter. Measured energies (including afterflow) are some 10–15% lower than those theoretically calculated. In part this difference is due to the arbitrary cut-off of 6.7θ in the measured energies

The calculated shock energy of 561 cal/g at one charge radius is to be compared with the measured bubble energy (Y in Eq 8.6 of the previous section) of 480 cal/g. The sum of these two energies of 1041 cal/g is remarkably close to the calorimetrically measured heat of detonation of TNT of 1090 cal/g (see Vol 7, H42 (Table 1))

Based on the measurements of Khristoforov

(Ref 2) we obtain the following comparison of shock and bubble energies (in cal/g) with the heat of detonation for 1.6g/cc PETN and Pb Azide:

	Shock Energy at $R/R_0=1$	Bubble Energy	Sum	Calorimetric Heat of Detonation
PETN	840	617	1457	1490
Lead Azide	155	209	364	390

As in the case of TNT, the sum of the shock and bubble energies for these two expls agrees closely with measured heats of detonation

In the preceding section (Figs 22 thru 24) we noted the possibly unexpected behavior of increased shock impulse and energy for low density charges whose peak pressures are appreciably lower than those of higher density or more "powerful" expls. These results are explained on the basis that in expls with large detonation pressures (PBX 9404), shock energy is rapidly dissipated as heat in the surrounding water, whereas in low detonation pressure expls (eg, Pentolite at 0.4125g/cc) this dissipation is much less pronounced (Ref 12). The following plots (Figs 25a–d) also from Ref 12, show how energy is partitioned. For example, in centrally detonated PBX 9404 (Fig 25b) at 10 charge

Table 12
Energy Dissipation in the Spherical Shock Wave from TNT

Distance (charge radii)	Peak Pressure (lb/in ²)		Shock Wave Energy (cal/gm)		
	Calculated	Measured	Calculated Total	Measured ¹ to 6.7θ	Afterflow ² to 6.7θ
1	460,000	—	561	—	—
2	167,000	—	495	—	—
3	91,460	—	449	—	—
5	42,800	—	396	—	—
7	26,600	—	366	—	—
10	16,400	16,250	340	255	43
15	9,670	9,640	316	250	30
20	6,720	6,720	302	246	23
25	1,090	1,090	293	244	19

¹ Computed from the integral $\frac{4\pi R^2}{\rho_0 c_0} \int_0^{6.7\theta} P^2 dt$

² Computed from the integral $\frac{4\pi R}{\rho_0} \int_0^{6.7\theta} P \int_0^t P dt' dt$

radii, 48% of the HE energy goes into heating the water; 29% into kinetic energy of the water; 13% is still in the bubble and 10% is in nondissipated internal energy of the water. Furthermore, com-

parison of Figs 25b and 25d shows that in PBX 9404, 48% of the energy is dissipated at 10 charge radii, whereas in 0.4125g/cc Pentolite only 6% of the energy appears as water heat

Fig 25 Calculated Energy Partition vs Position of the Main Shock, for Explosions in Water

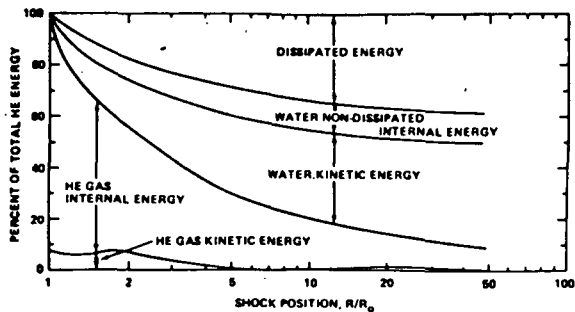

Fig 25(a) Pentolite, Centrally Detonated

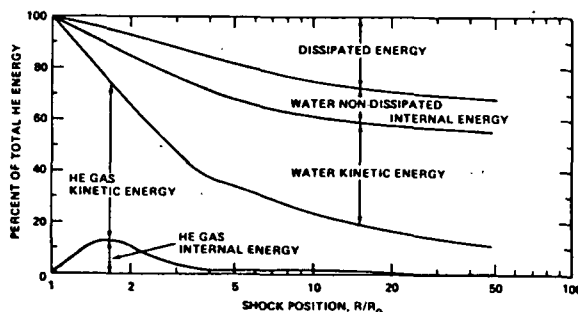

Fig 25 (c) Pentolite Constant Volume Explosion, $\rho_0 = 1.65$

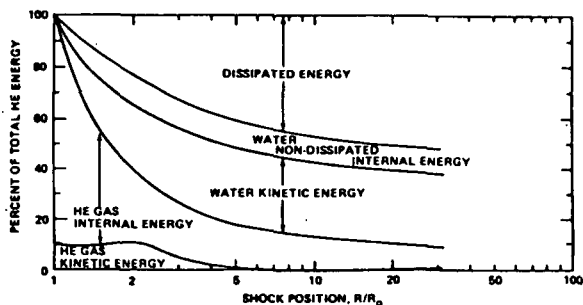

Fig 25 (b) PBX 9404, Centrally Detonated

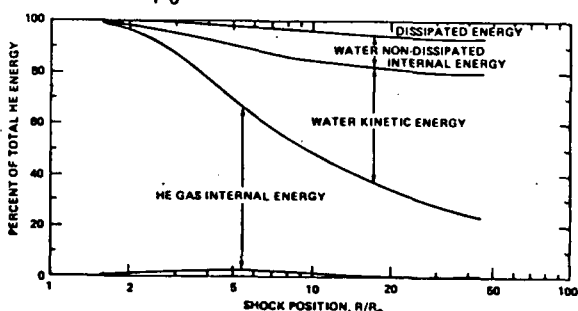

Fig 25 (d) Pentolite Constant Volume Explosion, $\rho_0 = 0.4125$

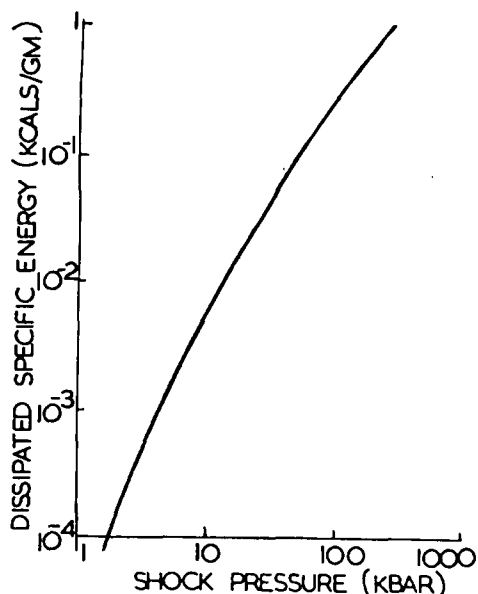

Fig 26 Variation of Energy Dissipation with Shock Pressure

Hicks (Ref 11) performed a series of calculations to investigate the "efficiency" of underwater expls. The calculations were based on idealized isentropes for the expln products to investigate the changes which can be caused in the pressure effects in water by variations in the energy distribution under the isentropes. The results show that modest gains are achievable for the impulse, flux and bubble energy, but that current expls are probably already quite close to the optimum for energy flux

Hicks, in agreement with other investigators, presents an approximate relation (Fig 26) which shows how energy dissipation is increased with initial shock pressure of the HE. His main conclusions for TNT are summarized in Table 13. Energy partition at the various shock radii are in reasonable accord with those of Ref 12

Table 13
Overall Energy Balance for TNT

Shock Front Radius	5	10	15	20	25	30
Fraction of energy lost as heat in water	0.287	0.328	0.346	0.357	0.364	0.369
Fraction of energy remaining in bubble	0.322	0.249	0.207	0.187	0.173	0.160
Fraction of energy in water in mechanical form	0.392	0.423	0.447	0.457	0.463	0.471
Fraction of energy in "shock wave"	0.232	0.229	0.209	0.201	0.205	0.207

Table 14
Comparison of Energy Distributions at 6 Charge Radii

	Penney and Dasgupta	Sternberg and Walker	MCCOY Calculations
Explosive	TNT $\rho_0 = 1.5$	Pentolite $\rho_0 = 1.65$	Q = 1000 $\gamma = 3.0$ $\rho_0 = 1.6$
Water KE	33%	34%	34%
Water IE (Shock htg) (Compressive)	27% 14%	34%) 13%)	65%
Bubble IE	25%	25%	< 1%

Lambourn (Ref 14) used the polytropic equation of state in a hydro-code called *McCoy* to examine energy partition of underwater expls. His time profiles of the energy distribution are shown in Fig 27 for a hypothetical expl described in its caption

Lambourn compares energy distributions computed by three different methods in Table 14. Note that water kinetic energy is found to be independent of the methods of computation. The computed internal energy of the water differs considerably for the different computational methods. The *McCoy* method produces a bubble internal energy which is much smaller than that computed by the other two methods

Additional conclusions of the Lambourn study are: (1) Initial shock pressure in the water increases with detonation pressure P_{cj} ; (2) In the body of the water the shock pressure depends mainly on the detonation energy Q and little on the adiabatic exponent γ of the detonation products. At 10 charge radii, the shock pressure increases by 20% for a 50% change in Q ; (3) Pulse width depends mainly on γ and not on Q , when the shock has reached 10 charge radii. A 20% increase in γ produces a 6% reduction in pulse width; and (4) The calculations suggest that about 30% of the available energy remains as internal energy of the water initially between the charge and $1\frac{1}{2}$ charge radii; and that when the shock has reached 14 charge radii, about 70% of the available energy is in the form of internal energy of the water

In Section II it was stated that measured underwater bubble energy is being used to estimate performance of commercial expls. Indeed, several publications have had this as their major objective (Refs 6, 7, 18, 20 & 21). Satyavratam and Veda (Ref 20) measured the underwater energy of a number of commercial expls (including *Slurries*). Their correlation of underwater energy with *Trauzl* Lead Block Values is shown in Fig 28. They also demonstrate that variations in measured shock wave energy of a non-aluminized *Slurry* are distributed in non-Gaussian fashion, while bubble energy variation follows a Gaussian distribution. This is shown in Fig 29

Satyavratam and Vedam also make the important point that the theory of underwater energy measurements was developed for relatively far-field effects, whereas the performance of commercial

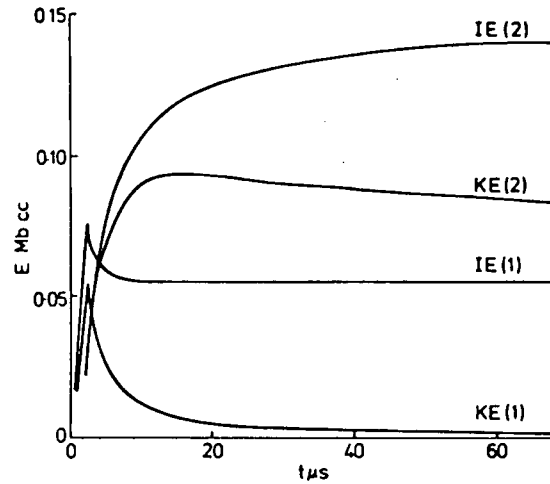

Fig 27 Energy History in Water Region (1) ($R < 1.5\text{ cm}$) and Region (2) ($R > 1.5\text{ cm}$) $\rho_0 = 1.6\text{ g cm}^{-3}$, $Q = 1000\text{ cal g}^{-1}$, $\gamma = 3.0$

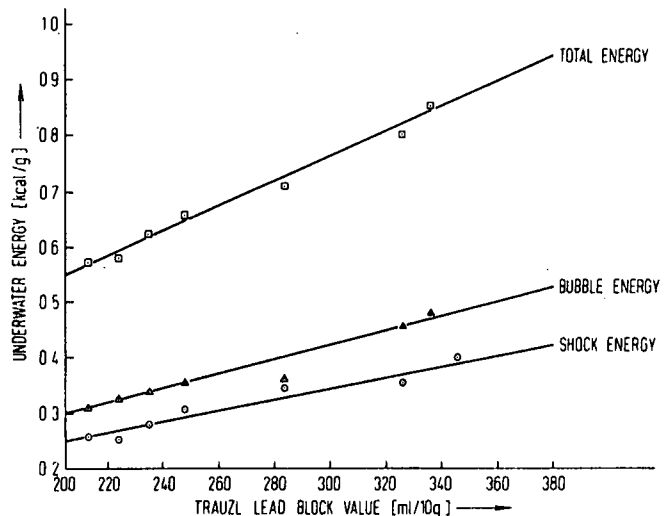

Fig 28 Correlation Between the Underwater Values and the Trauzl Lead Block Values

expls in mining and construction should be determined at distances close to the charge. Consequently they suggest a reevaluation of the eqns used in underwater energy measurements to include near-field perturbations

A correlation between measured bubble energy and computed expansion work, E_{wk} , is presented in Fig 30 (Ref 16). The quantity E_{wk} is obtained from theoretical considerations. Usually it is less than the heat of detonation

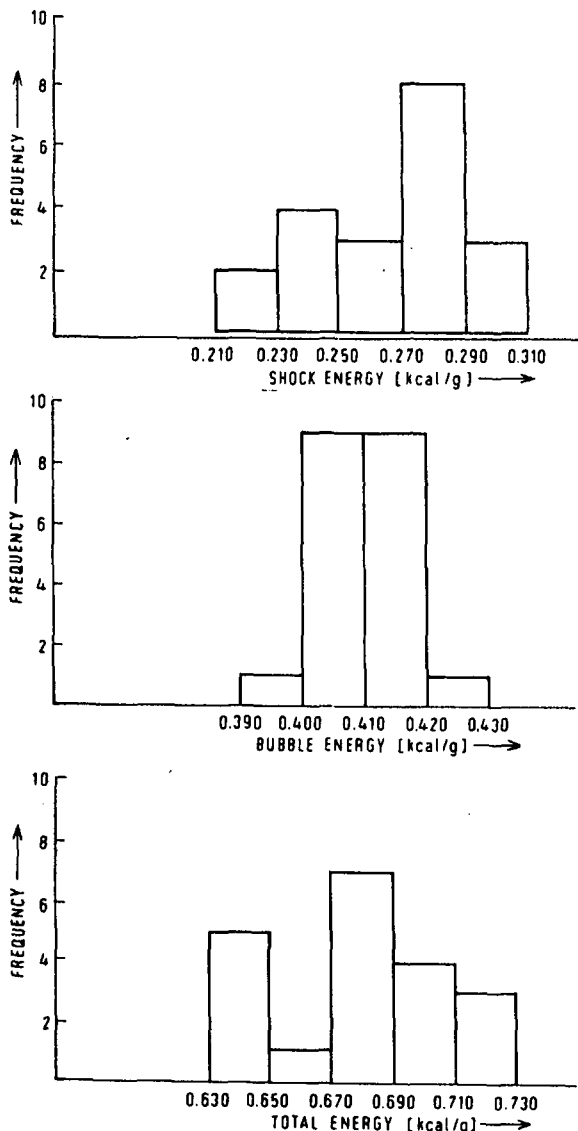

Fig 29 Histogram of the Underwater Energies

Bjarnholt and coworkers (Refs 13 and 21) used a semi-empirical approach to estimate the "useful" energy of HE via underwater expln energy measurements. In essence, their approach involves computation of a *shock loss factor*, $\mu > 1$, to estimate the shock energy at the HE/water boundary from measured shock energies at some distance from the HE. This is coupled with the assumption that the measured bubble energy at some distance from the HE equals the bubble energy at the HE/water boundary. Then the total underwater expansion work per unit mass of HE, A_0 , is given by:

$$A_0 = K_f(\mu e_s + e_b)$$

where:

- K_f = Charge geometry factor
- μ = Shock loss factor
- e_s = Primary shock energy at the gage per mass unit of expl
- e_b = Bubble energy per mass unit of expl

The loss factor is claimed to correlate with a rather crude estimate of detonation pressure (usually an underestimate) as shown in Fig 31

Usually $A_0 \approx Q$ as shown in Table 15, from Ref 21

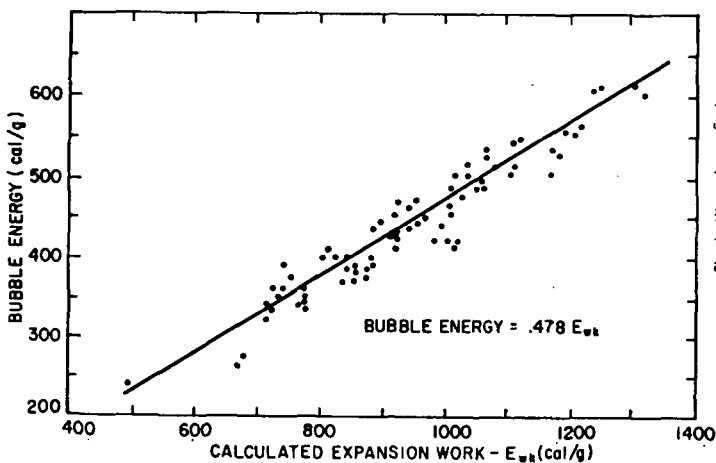

Fig 30 This chart shows the correlation between the calculated expansion work (represented by E_{wk}) and measured underwater bubble energy

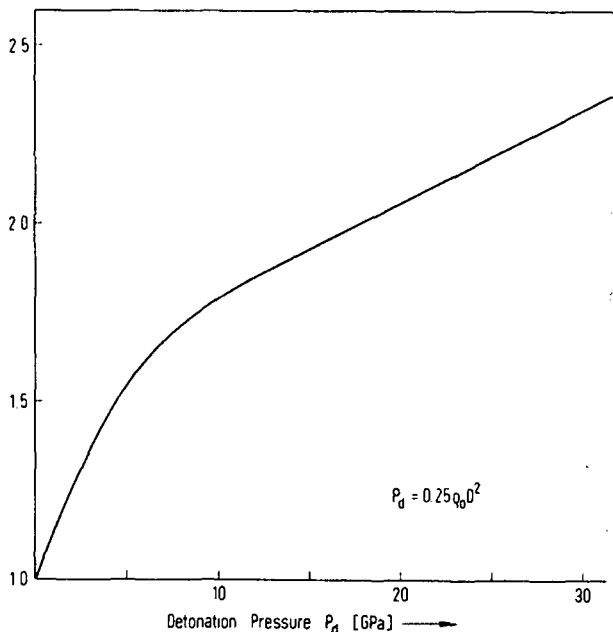

Fig 31 Shock Wave Loss Factor μ as a Function of Detonation Pressure P_d of the Explosive (Ref 2)

Table 15
Comparison of Experimental Underwater Expansion Work A_0 and Heat of Detonation
as Measured in a Detonation Calorimeter

Explosive	ρ_0 (kg/m ³)	Detonation Pressure P_d (GPa)	A_0 (MJ/kg)	Q (MJ/kg)	A_0/Q
PETN	1000	7.3	5.54	5.73	0.97
Nitromethane	1130	11.2	4.45	4.44	1.00
HMX	1190	13.4	5.09	5.13	0.99
TNT	1580	18.8	4.09	4.27	0.96
Comp B	1690	25.7	4.78	4.69	1.02

Table 16
Composition and Properties of Explosives

Explosive	Composition (Weight %)	Density (g/cm ³)	Oxygen Balance (%)
Oxygen Balanced CHNO Explosives			
Pentanex	45 PETN/37 AN/2 Glycol 15.5 H ₂ O/0.5 Guar	1.48	-0.3
EGDN	100 EGDN	1.48	0.0
ANFO	94.6 AN/5.4 FO	0.90	0.1
Oxygen Deficient CHNO Explosives			
PETN	100 PETN	1.00	-10.1
HMX	100 HMX	1.20	-21.6
NM	100 NM	1.13	-39.3
Hexotol 60/40	59 RDX/40 TNT/1 Wax	1.69	-46.4
86 PETN/14 FO	86 PETN/14 FO	1.08	-57.4
TNT	100 TNT	1.58	-74.0
Aluminized Explosives			
ANFOAL 10	87.4 AN/2.6 FO/10 Al	0.90	-0.5
WG 2	MMAN sensitive wattergel expl. 7% Al (60 μ m)	1.34	-0.3
WG 4	MMAN sensitive wattergel expl. 13% Al (60 μ m)	1.36	-0.5
Hexotonal 15	42.1 RDX/42.1 TNT/0.8 Wax/ 15 Al (30 μ m)	1.76	-56.3

EGDN – Ethylene Glycol Dinitrate
MMAN – Mono Methyl Amine Nitrate
AN – Ammonium Nitrate Prills
FO – Fuel Oil No 1

Table 17
Experimental and Calculated Data on Explosives

Shot No †	Explosive	Charge Weight (kg)	Charge Shape*/ Initiat	Charge Shape Factor k_f	Shock Energy (MJ/kg)	Bubble Energy (MJ/kg)	Deton Press (GPa)	Loss Factor μ	Exper. Expans. Work A_0 (MJ/kg)	$(-\Delta H_d)$ BKW Code# (MJ/kg)	$(-\Delta U)$ Nitrodynne Code (MJ/kg)
Oxygen Balanced CHNO Explosives											
31L	Pentanex	1.72	C/d + 5	1.08	0.85	1.79	17.0	1.99	3.76	3.90	4.00
40L	Pentanex	1.48	B/d + 23	1.00	0.97	1.86	18.0	2.02	3.82	3.90	4.00
43L	Pentanex	7.26	B/d + 23	1.00	0.99	1.88	18.0	2.02	3.88	3.90	4.00
201	EGDN	0.392	E/d + 12	1.02	1.50	2.77	19.7	2.07	5.99	6.70	6.82
203	EGDN	0.190	E/d + 12	1.03	1.47	2.74	19.7	2.07	5.96	6.70	6.82
88	ANFO	0.360	E/d + 19	1.02	0.92	2.01	2.0	1.25	3.22	3.78	3.89
38L	ANFO	2.30	E/d + 95	1.02	0.92	2.08	2.8	1.34	3.31	3.78	3.89
36L	ANFO	2.07	C/d	1.10	0.98	1.90	2.3	1.28	3.47	3.78	3.89
37L	ANFO	2.03	C/d + 95	1.10	1.00	1.92	2.3	1.28	3.52	3.78	3.89
41L	ANFO	1.48	B/d + 23	1.00	0.67	1.73	2.0	1.25	2.55	3.78	3.89
45L	ANFO	4.93	B/d + 140	1.00	1.08	2.39	2.3	1.28	3.77	3.78	3.89
46L	ANFO	10.05	B/d + 140	1.00	1.12	2.43	2.3	1.28	3.86	3.78	3.89
47L	ANFO	9.91	B/d + 23	1.00	0.82	2.22	2.0	1.25	3.25	3.78	3.89
Oxygen Deficient CHNO Explosives											
235	PETN	0.313	E/d	1.02	1.44	3.00	7.3	1.69	5.54	5.76	5.88
281	HMX	0.340	E/d + 6	1.02	1.40	2.33	13.4	1.90	5.09	5.76	5.28
199	NM	0.294	E/d + 20	1.02	1.16	2.23	11.2	1.84	4.45	5.43	4.82
254	Hexotol 60/40	0.426	E/d + 12	1.01	1.19	2.08	25.7	2.23	4.78	5.70	5.60
253	86 PETN/14 FO	0.298	E/d + 12	1.02	1.11	2.19	8.2	1.74	4.20	5.22	4.53
272	TNT	0.255	S/d + 2	1.00	1.02	2.06	18.8	2.04	4.14	5.33	4.95
4L	TNT	1.97	S/d + 2	1.00	0.97	2.11	18.8	2.04	4.09	5.33	4.95
7L	TNT	4.99	S/d + 2	1.00	0.97	2.11	18.8	2.04	4.09	5.33	4.95
35L	TNT	2.34	C/d + 20	1.08	0.96	1.91	18.8	2.04	4.18	5.33	4.95

(continued)

Table 17 (continuation)
Experimental and Calculated Data on Explosives

Shot No †	Explosive	Charge Weight (kg)	Charge Shape*/ Initiat	Charge Shape Factor k_f	Shock Energy (MJ/kg)	Bubble Energy (MJ/kg)	Deton Press (GPa)	Loss Factor μ	Exper. Expans. Work A_0 (MJ/kg)	($-\Delta H_d$) BKW Code# (MJ/kg)	($-\Delta U$) Nitrodyne Code (MJ/kg)
Aluminized Explosives											
53	ANFOAL 10 (30)**	0.364	E/d + 19	1.02	1.27	2.93	2.0	1.25	4.61	5.45	5.56
66	ANFOAL 10 (120)	0.380	E/d + 19	1.02	1.27	2.93	2.0	1.25	4.61	5.45	5.56
81	ANFOAL 10 (600)	0.356	E/d + 19	1.02	1.13	2.80	2.0	1.25	4.19	5.45	5.56
289E	ANFOAL 10 (60)	2.20	C/d + 150	1.10	1.50	2.65	2.5	1.31	5.08	5.45	5.56
1E	WG 2	10.12	C/d + 360	1.08	1.17	2.38	7.4	1.70	4.72	—	4.71
8E	WG 4	9.74	C/d + 360	1.08	1.26	3.00	6.4	1.65	5.49	—	6.09
255	Hexotonal 15	0.255	E/d + 12	1.01	1.35	2.89	25.7	2.23	5.96	7.61	7.60

*See Fig 7; d = detonator No 8; d + x = detonator No 8 + x grams of pressed phlegm PETN. Cylindrical charges had a diameter of 75mm

†Shots with an L or E after the shot No were shot at 10m charge depth, 15m from the gage

#CJ values

**Mean aluminum particle size (μm)

In Ref 13, A_0 values are also given for several commercial expls. The expl compns are shown in Table 16 and the A_0 data in Table 17

In general, A_0 is slightly less than Q_{code} for oxygen balanced expls (EGDN strangely enough is an exception), A_0 is appreciably less than Q_{code} for appreciably oxygen deficient expls as well as for aluminized expls

According to Bjarnholt (Ref 21), "Noren has tried to correlate rock fragmentation in bench blasting with measured underwater bubble energies for some watergel explosives. The heat of explosion for the explosives was varied mainly by different amounts of aluminium. He found that bubble energy is no definite indicator of an explosive's fragmentation performance in competent rocks like granite and limestone."

Bjarnholt suggests that, to break and fragment competent rock, comparison of rock blasting capacity relative to a reference explosive(r) be made as follows:

Bench blasting

Equal explosive weight comparison

$$B_p = \frac{(\mu e_s + 0.6e_b)}{(\mu e_s + 0.6e_b)_r}$$

Equal explosive volume comparison

$$b_p = \rho_0 B_p / (\rho_0 B_p)_r$$

Crater blasting

Equal explosive weight comparison

$$B_p = \frac{(\mu e_s + 0.2e_b)}{(\mu e_s + 0.2e_b)_r}$$

Equal explosive volume comparison

$$b_k = \rho_0 B_k / (\rho_0 B_k)_r$$

The above may be overestimates if there is excessive crushing of the rock around the bore-hole

IX. Shock Interactions

Detailed discussion of shock interactions between multiple underwater charges, interactions with the surface or with solid obstructions are beyond the scope of this article. Only a cursory overview of these phenomena will be presented

Coleburn & Roslund (Ref 8) studied *Mach wave* formation by the interaction of spherical shock waves in water. The abstract of their paper reads as follows: "High-speed framing

camera techniques were used to study underwater shock wave interactions and the associated spherical flow from simultaneous detonation of twin, separated explosive spheres. Critical angles for Mach wave formation varied from 36° to 41° for incident pressures between 6.5kbar and 1.62kbar. Predicted critical points for the onset of Mach formation were calculated using oblique shock reflection theory and an energy-dependent form of the Hugoniot equation-of-state for water." Their schematic of the formation of a Mach bridge is shown in Fig 32

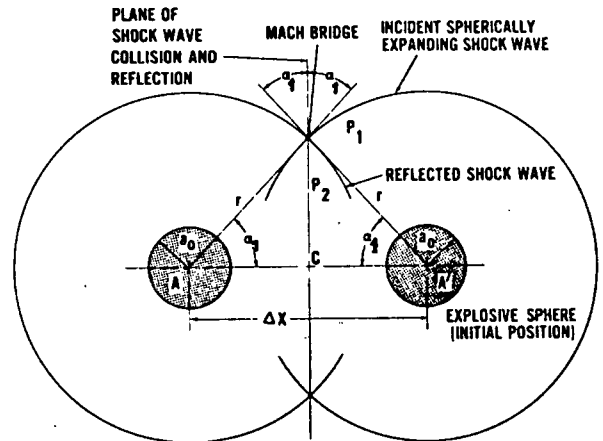

Fig 32 The Separated Charge Arrangement and a Sketch of Shock Wave Positions at the Point of Mach Wave Formation

A comprehensive investigation of spherical expln shock waves in water was made by Enig (Ref 15). He summarized his findings as follows: "Numerical solutions have been obtained for the unsteady phenomena of regular and Mach reflection occurring when two identical spherical explosive charges of pentolite, of radius a_0 and center-to-center separation distance $2l$, are simultaneously detonated underwater. Calculations have been performed for $3.0 \leq 2l/a_0 \leq 11.1$ with an equation of state of water due to Sternberg and Walker (S-W). Good agreement has been obtained between the numerical results and the existing experimental shadowgraphs for the motion of the shock waves and the development of the Mach stem. The characteristic properties of water have been analyzed in detail with the aid of oblique shock theory. The von Neumann simple three-shock solution does not

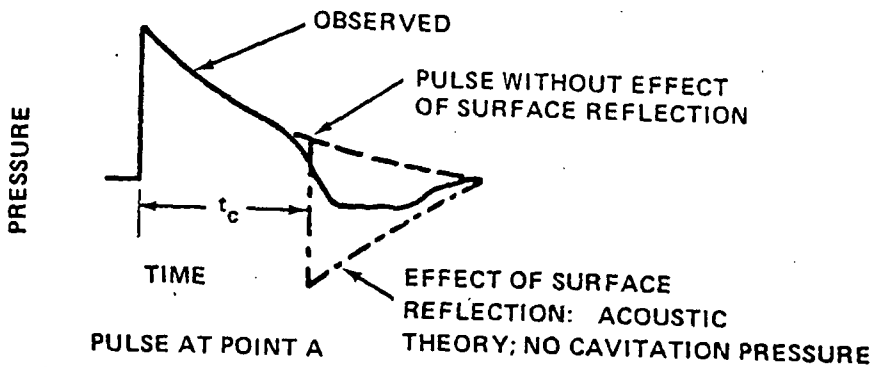
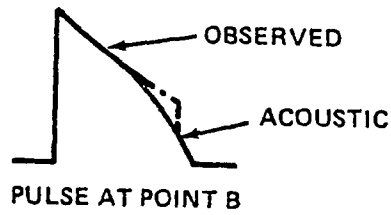
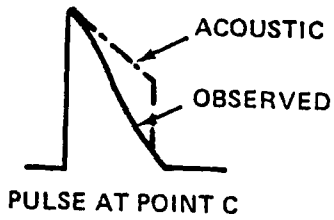
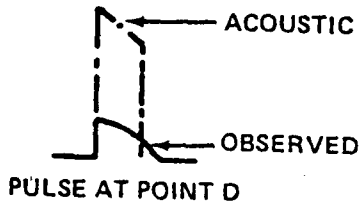
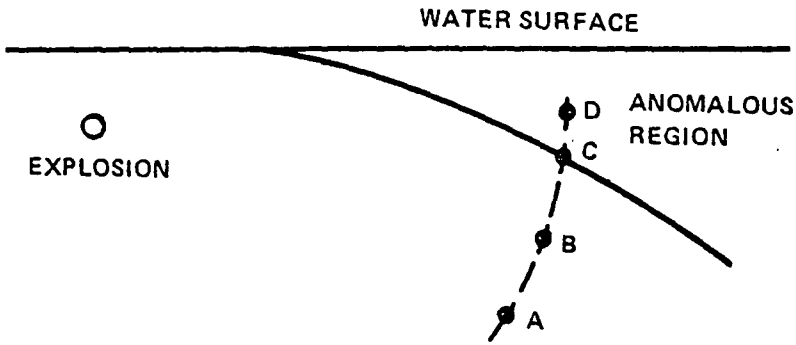

Fig 33 Typical Pressure Pulses Affected by Surface Reflection

occur for incident shock pressures below 5 kilobars if the S-W or the HOM equations of state are used to represent water. The use of the S-W and HOM equations in oblique shock theory correctly predicts the Mach stem pressure at the critical shock angle while a γ -law type does not."

The S-W equation of state is given in Ref 4, while the HOM equation of state is based on a one-dimensional hydrodynamic code developed at LASL

Fig 33, from Ref 17, is a schematic representation of the effects of a nearby surface on pressure pulse shapes at various distances below the water surface. It also shows the expected pulse shapes for acoustic rather than shock waves

A shock wave in water will be reflected as a rarefaction wave when it encounters another medium less dense than water, eg, a water/air boundary. The rarefaction wave, generated by the reflection of the primary shock wave from the surface, propagates downward and relieves the pressure behind the primary shock wave. If the shock wave is treated as a weak (acoustic) wave, this interaction instantaneously decreases the pressure in the primary shock wave to a negative value, as shown by the broken line in Fig 33 (Ref 17), Point A. Cavitation occurs in seawater when its pressure decreases to a value somewhat above its vapor pressure. The pressure of the primary shock wave is, therefore, reduced to a value which is usually so close to ambient water pressure that the shock wave pulse appears to have been truncated

For a strong primary shock wave, the reflected rarefaction wave propagates into water that has already been set in motion. Consequently, the rarefaction wave arrives earlier than predicted from the acoustic approximation, which ignores the particle velocity. Thus the pressure cutoff is not instantaneous. This effect typically gives a pulse shape shown by the solid line for Point A of Fig 33. The shallower the point at which pressure measurements are made, the sooner the primary shock pulse is truncated and the shorter its duration (see Fig 33, Point B). At shallow enough locations, the rarefaction wave interacts with the shock front and reduces the peak pressure (see Fig 33, Points C and D). The region in which the peak pressure is reduced is known as the "anomalous region"

The effects of surface reflection decrease

rapidly with increased depth of either the expln or the point of measurement. Conversely, as the depth of burst is decreased (or the yield increased for a given depth of burst), the effects increase. The size of the anomalous region increases with decreased depth of burst until, for a surface burst, the anomalous region includes all points beneath the water surface except those close to the expln and directly under it

A thin target impacted by a strong enough underwater shock will deform, and in so doing the water in front of the target will experience a negative pressure and *cavitate*. However, diffraction waves due to presence of the target will tend to counteract cavitation. A cavitation criterion proposed by Kirkwood (discussed by Cole in Ref 1, Chapt 10) is that diffraction time at the center of the target (plate) must exceed the cavitation time. According to Cole (Ref 1, Chapt 10): "This cavitation time depends of course on the motion of this part of the plate, but an approximation to the initial motion is obtained by assuming the center to act as an element of an infinite free plate of mass m per unit area. If cavitation occurs when the resultant pressure on this element first becomes zero, the time after arrival of an exponential pressure wave is the Taylor cavitation time θ_c obtained in section 10.4, which is

$$\theta_c = \frac{\theta}{\beta - 1} \log_e \beta, \text{ where } \beta = \frac{\rho_0 c_0 \theta}{m}$$

Kirkwood's criterion may therefore be expressed for a circular plate by the proposition that if θ_d exceeds θ_c cavitation will occur. Corresponding estimates for other types of target and incident pressure wave can be formulated in a similar way by suitable estimate of diffraction time from the dimensions of the structure and its response to pressure.

Although the simple criterion of comparing the diffraction and free plate cavitation times is admittedly rough, its usefulness and approximate validity has been well established experimentally for small circular plates." And: "It has also been found that positions of the cavitation boundary calculated by similar methods are in good agreement with observed values, and the simple cavitation criteria thus furnish a quite reliable guide for analysis. The cavitation time is smaller for thin plates and short durations of

the incident wave, and the diffraction time increases with the lateral dimensions. Cavitation therefore occurs for relatively thin plates, or short durations of shock wave pressure."

Some of the kinetic energy of the cavitated water can be delivered to the target (plate or diaphragm) and enhance its deformation. According to Cole: "A mechanism for providing this reloading has been suggested and examined by Kirkwood. The physical basis of the theory lies in the fact that, as the diaphragm decelerates, the pressure in front of it increases in a manner calculable from its equation of motion. When this pressure becomes larger than the cavitation pressure, the cavitation is destroyed and a reflected wave of compression moves back into the cavitated regions. The water between the plate and the front of recompression is moving with the plate in the noncompressive approximation, and the kinetic energy of both this layer and the plate is ultimately dissipated as plastic work. If the reloading wave is idealized to be a plane wave front, moving into the cavitated water with forward velocity at essentially zero pressure, its velocity and hence the thickness of the reloading layer of water can be computed from the pressure behind the front and the Rankine-Hugoniot condition at the front.

Kirkwood's application of these considerations gives the result that the deformation predicted by Eq. (10.23) should be increased by a factor $(1 + \beta/4)^{1/2}$, his equation being

$$z_c(t_m) = \frac{P_m a}{\rho_0 c_0} \sqrt{\frac{2m}{\sigma_0 h}} \beta^{1-\beta} \left(1 + \frac{\beta}{4}\right)^{1/2}$$

Here Z_c is the deformation of the diaphragm, a its radius, h its thickness and σ_0 its yield strength. This Eqn is of importance in metal forming by expls (Ref 3)

Written by J. ROTH

Refs: 1) R.H. Cole, "Underwater Explosions", Dover Publications, NY (1948) 2) B.D. Khristoforov, ZhPriklMechiTechnFiz No 4, 118 (1961) 3) J. Roth, TransactASM 56, 850 (1963) 4) W.A. Wolker & H.M. Sternberg, 4th Deton Symp (1965), 27 5) T.P. Liddiard, Ibid, 487 6) C.W. Eilo, Explosives Engineer No 1, 14 (1968) 7) E.K. Hurley, Ibid No 2, 2 (1970) 8) N.L. Coleburn & L.A. Roslund, 5th Deton Symp (1970), 581 9) L.W. Hantel & W.C. Davis, Ibid, 599 10) Anon, EngrgDes-

Hndbk, "Principles of Explosive Behavior", AMCP 706-180 (1972), Chapt 13 11) J.A. Hicks et al, ERDE Tech Rept 164 (1974) 12) H.M. Sternberg & H. Hurwitz, 6th Deton Symp (1976), 528 13) G. Bjarnholt & R. Holmberg, Ibid, 540 14) B.D. Lambourn, Ibid, 561 15) J.W. Enig, Ibid, 570 16) Anon, "Blasters' Handbook", E.I. duPont de Nemours & Co, Wilmington (1977) 17) M.M. Swisdak, NSWC/WOL TR 76-116 (1978) 18) P. Wollert-Johansen, Proplnts & Expls 5, 54 (1980) 19) W. Christman & P. Lingens, Ibid, 59 20) P.V. Satyavratam & R. Vedam, Ibid, 62 21) G. Bjarnholt, Ibid, 67

Underwater Mines. See under "Mines (Military)" in Vol 8, M131-R to M133-L

Underwater Storage of Smokeless Powder.

Based on favorable reports from abroad on the underwater storage of smokeless powder, a program was conducted at PicArns in which proplnt grains of various calibers stored in perforated containers, were submerged 3 ft below the surface of Picatinny Lake. After six months it was claimed that no changes had taken place (Ref). The advantages of underwater storage include prolonging the stability of the powder, the almost complete elimination of danger from fire and expln, and a reduction in the extent of supervision required over storage areas
Ref: F. Olsen, ArmyOrdn 4, 372 (1924) & CA 18, 2250 (1924)

Unibel. Brit permitted expl, used in coal mine blasting, contg NG (+ NGk) 10.0-12.0, NC 0.1-0.6, Amm nitrate 46.5-49.5, Na chloride 34.5-36.5, and other ingredients 0.25-1.25%; d 1.15g/cc; strength (% that of of Blasting Gelatine) 40

Refs: 1) J. Taylor, "Detonation in Condensed Explosives", Clarendon Press, Oxford (1952), 20 2) J. Taylor & P.F. Gay, "British Coal Mining Explosives", G. Newnes Ltd, London (1958), 103

Unicell-100. DuPont code name for 1,5-Endomethylene-1,3,5,7-tetraaza-2,4,6,8-cyclooctane. See Vol 5, E90-R to E91-R

Unifrax. Brit permitted expl, used in coal mine blasting, contg NG (+ NGk) 11.2–13.2, Amm nitrate 48.4–51.4, Na chloride 29.0–32.0, plant fiber 6.2–8.2, and other ingredients 0.21–2.26%; d 0.8g/cc; strength (% that of Blasting Gelatine) 46

Ref: J. Taylor & P.F. Gay, "British Coal Mining Explosives", G. Newnes Ltd, London (1958), 101 & 105

Unigel. Brit permitted expl, used in coal mine blasting, contg NG (+ NGk) 26.3–28.3, NC 0.4–1.4, MNT 0.2–2.2, Amm nitrate 29.5–32.5, Amm chloride 28.3–30.3, china clay 3.3–5.3, oat husk meal 0.4–2.4, diammonium phosphate 0.1–1.1, barytes 3.3–5.3, and other ingredients 0.002–0.11%; d 1.7g/cc; deton vel 2500m/sec; expln temp 3080°; strength (% that of Blasting Gelatine) 44 (Ref 1)

Meyer (Ref 2) states that *Unigel* is the trade name of a semigelatinous industrial expl distributed in the USA by Hercules with a d of 1.26g/cc and a wt strength of 67%. Under the same name, a gelatinous permitted expl is marketed by I.C.I. in the U.K. with a d of 1.55g/cc and a wt strength of 42%

Refs: 1) J. Taylor & P.F. Gay, "British Coal Mining Explosives", G. Newnes Ltd, London (1958), 100 & 104 2) R. Meyer, "Explosives", Verlag Chemie, NY (1977), 310

Unigex. Brit permitted expl, used in coal mine blasting, contg NG (+ NGk) 15.7–17.7, NC 0.1–1.1, Na nitrate 43.5–46.5, Amm chloride 28.0–30.0, china clay 3.0–5.0, woodmeal 1.0–3.0, wheat flour 0.5–1.5, and other ingredients 0.6–2.6%; d 1.3g/cc; deton vel 2100 m/sec; expln temp 2580°; strength (% that of Blasting Gelatine) 42 (Refs 1 & 2)

Meyer (Ref 3) states that *Unigex* is the trade name of a semigelatinous permitted expl distributed in the U.K. by I.C.I., belonging to Brit classification group P3, with a d of 1.35g/cc and a wt strength of 47%

Refs: 1) J. Taylor & G.P. Sillitto, *TrInstMining-Engrs(London)* 110, 355–60 (1951) & CA 45, 8771 (1951) 2) J. Taylor & P.F. Gay, "British Coal Mining Explosives", G. Newnes Ltd, London (1958), 99 & 104 3) R. Meyer, "Explosives", Verlag Chemie, NY (1977), 310

Unikol. Brit permitted expl, used in coal mine blasting, contg NG (+ NGk) 9.0–11.0, Amm nitrate 35.1–37.1, Na nitrate 12.5–14.5, Na chloride 28.9–31.9, diammonium phosphate 9.0–11.0, and other ingredients 0.05–2.0%; d 0.8g/cc; strength (% that of Blasting Gelatine) 39

Refs: 1) J. Taylor, "Detonation in Condensed Explosives", Clarendon Press, Oxford (1952), 20 2) J. Taylor & P.F. Gay, "British Coal Mining Explosives", G. Newnes Ltd, London (1958), 101 & 105

Unionite. A smokeless powder, patented in 1898 by Schratzenhaller of Austria, prepd by nitration of filter paper sheets, washing the sheets with w, and soaking for 3–4 hrs in a 5% ammonia soln. The resulting NC was dried at 22°

Ref: Daniel (1902), 779

Uniperox 60. A proprietary mixt of cyclic hydrocarbon hydroperoxides contg 6 to 8 C atoms. Its avg mw is 130, which corresponds to the empirical formula $C_7H_{13}O_2H$. The commercial product, manufd by the R.T. Collier Corp, Los Angeles, Cal, is a water-white liq contg 60–65% by wt of hydroperoxide in admixt with alcs and ketones of about the same boiling range. Its d is 0.96g/cc; mp -80° ; bp (decompn at 110°); flash pt 80° ; sol in w 0.5% by wt; and is completely miscible with alcs, ethers, ketones, esters and petroleum fractions

Uniperox 60 is very reactive as an oxidizing agent, as well as a polymerization catalyst. It is stable in storage to temps of about 90° , but it decompn noticeably at 100° within a few hrs. At $100-115^\circ$, an exothermic decompn occurs, accompanied by gas evolution and a sudden rise in temp up to 200°

Its expl props were detd at PicArSn (Ref 2), which indicate it is a mild expl:

Brisance. In the Sand Test 16.0g of sand crushed vs 49.0 for TNT

Explosion temp. Smokes at 140°

Impact Sensitivity. BuMines app, 2-kg wt, 100+cm

Toxicity. The undiluted peroxide produces mild burns if left on the skin for any length of time.

Dilute solns are practically harmless. Four grams of Uniperox 60, emulsified with water, was found to be lethal to rabbits when administered orally, while one gram proved to be non-toxic

Refs: 1) Anon, pamphlet from R.T. Collier Corp, Los Angeles, Ca (May 1947) 2) W. Anderson, PicArnsChemLabRept No 127153 (1949)

Uniprof. Trade name of a powdery permitted expl distributed in the U.K. by I.C.I., belonging to Brit classification group P3, with a d of 1.23g/cc and a wt strength of 50%

Ref: R. Meyer, "Explosives", Verlag Chemie, NY (1977), 310

Unirend. Brit permitted expl, used in coal mine blasting, contg TNT 10.7–12.7, Amm nitrate 49.1–52.1, Na chloride 36.2–39.2, and other ingredients 0.002–0.11%; d 1.2g/cc; deton vel 3000m/sec (1¼" diam); expln temp 2830°; strength (% that of Blasting Gelatine) 42
Ref: J. Taylor & P.F. Gay, "British Coal Mining Explosives", G. Newnes Ltd, London (1958), 98 & 103

Unit Deflective Charge (U.D.C.). See under "U.D.C. (Unit Deflective Charge)" in this Vol

United States Bureau of Alcohol, Tobacco and Firearms. See under "Tagging of Explosives" in Vol 9, T3-L ff

United States Naval Friction Fuse Composition. A nineteenth century formulation contg K chlorate 45.00, Sb sulfide 20.75, amorph P 5.75 and charcoal 28.50%

Ref: Daniel (1902), 779

United States Naval Smokeless Powder. A nineteenth century proplnt formulation contg NC (12.75% N) 80, Ba nitrate 15, K nitrate 4 and Ca carbonate 1%. It was prepd by thoroughly mixing sol (12% N) and insol (13% N) NC with Ca carbonate, and then with concd K nitrate and Ba nitrate solns in boiling w. After drying the mass at 48°, the NC was gelatinized by thorough stirring with ether-alc (2:1), followed by grainng and drying

Ref: Daniel (1902), 779–80

United States Smokeless Powders (San Francisco). Patented at the close of the nineteenth century, with typical formulations contg Amm Picrate, Amm nitrate and NG (1892) or Amm Picrate, K or Na picrate and Amm bichromate (1898)

Ref: Daniel (1902), 780

Unité MB. See under "Coefficient de viscosité des nitrocelluloses industrielles" in Vol 3, C390-R

Universal Explosive Destructor, M10. A HE charge in an assembled metal device initiated by means of blasting caps or mine activators with standard firing devices. The destructor has booster cups contg Tetryl pellets. The chief function of the destructor is the conversion of loaded projectiles and bombs to improvised demolition charges and the destruction of abandoned ammo (Fig 1)

Refs: 1) Anon, "Demolition Materials", TM 9-1375-200 (1964), 41–44 2) Anon, "Explosives and Demolitions", FM 5-25 (1971)

Universal Italiana. See under "Italian Explosives and Related Items" in Vol 7, I181-R

Universal Powder Co. Chlorate Explosive. Two samples of proprietary Chlorate expls submitted by the Universal Powder Co were studied at PicArns, and their expl, stability, and physical characteristics determined. These samples had about the same sensitivity to impact as TNT when tested on the BuMines impact app using a 2-kg hammer. They behaved satisfactorily in

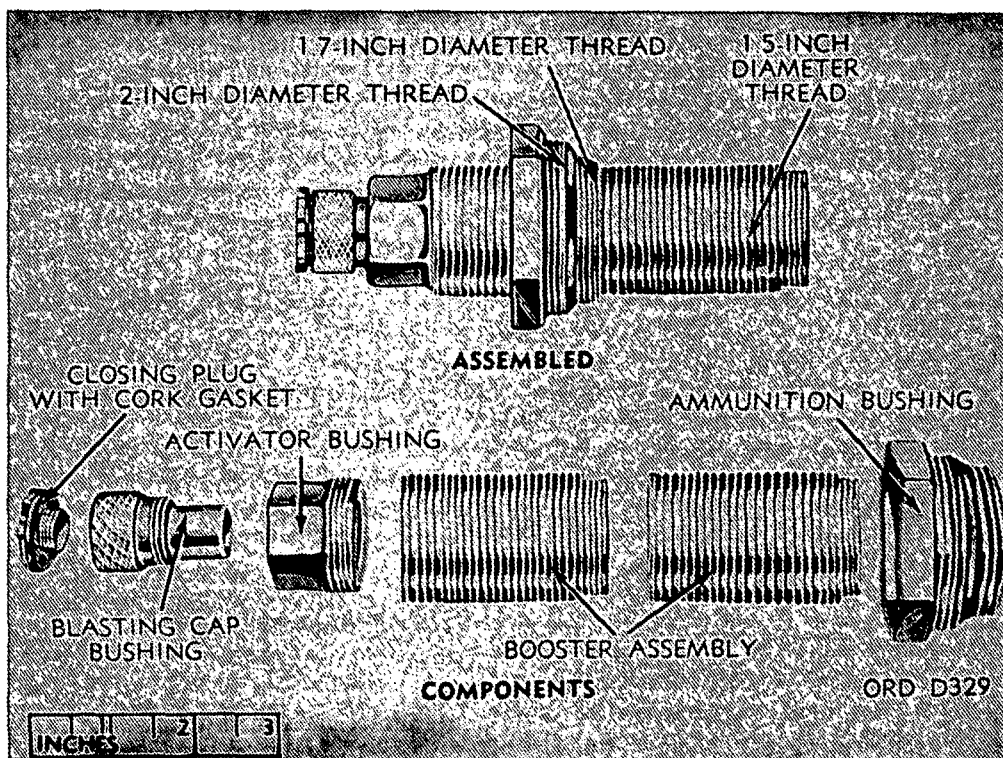

Fig 1 Destructor, Explosive, Universal, M10

the Expln Temp test, the Vac Stab test, and the 100° Heat test, being comparable to acceptable military expls

The brisance of the Chlorate expls was found to be less than that of TNT or the then standard Nitrostarch Demolition Expl. The samples were much more sensitive to rifle bullet impact and friction than TNT, and somewhat more sensitive in these tests than the Nitrostarch Demolition Expl. They were quite hygroscopic at 90% RH at 30°, and contained a liq constituent even at room temp which would tend to exude upon storage or use of the expl at elevated atm temps

It was concluded that the Chlorate expl offered no promise for use in military ammo
 Ref: W.R. Tomlinson, "Chlorate Explosives Developed by the Universal Powder Company", PATR 1230 (1943)

Unloading and Recovery of Ammunition Contents. See in Vol 9 under "Reclamation of Energetic Material Components from Ordnance Ammunition" (R146-R) and "Renovation of Ammunition" (R156-R)

Unsymmetrical Dimethyl Hydrazine (UDMH). See in Vol 5, D1344-L to D1346-R under "Dimethylhydrazine and Derivatives", and in this Vol under "UDMH"

"Up-and-Down" Method. See in Vol 3, C376-L to C376-R under "Coal Mining Explosives, Testing for Permissibility"; in Vol 7, I36-R to I37-L under "Impact, Initiation of Explosion By"; and in Vol 8, P378-L to P379 (Table 1) under "Primers"

Uracil [2,4(1H,3H)-Pyrimidinedione]

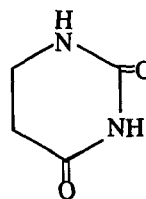

$C_4H_4N_2O_2$; mw 112.09; N 24.99%; white ndles; mp 335°, 338° (sep values).
 V sol in hot w; sol in aq ammonia; sl sol in cold w, eth and ethanol. Prepn is by hydrolysis of nucleic acids

5-Nitro Uracil [5-Nitro-2,4-dioxotetrahydropyrimidin (Ger)]

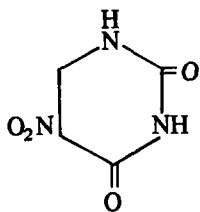

$C_4H_3N_3O_4$; mw 157.09;
N 27.85%; OB to CO_2
-58.3%; gold ndles (from
ethanol); mp $> 300^\circ$ (explds).
V sol in hot w; sol in hot
ethanol. Prepn is by nitra-
tion of uracil with concd
nitric acid at $50-60^\circ$

Refs: 1) Beil **24**, 320, (313) & [171]
2) Merck (1976), 1264 (No 9506) 3) ChemRub-
Hndbk (1978), C-536

Uraform-Ammonium Nitrate. See in Vol 1,
A366-L & R under "Ammonium Nitrate, Fer-
tilizer Grade (FGAN)"

Uranium. U; at no 92; at wt 238.03; silvery
white metal, tarnishes in air; mp $1405.3^\circ K$; bp
 $4091^\circ K$; d 19.05g/cc

Max allowable concn $7 \times 10^{-11} \mu Ci/ml$ in air,
sol natural U; $5 \times 10^{-4} \mu Ci/ml$ in water, sol
natural U (Ref 33)

U, the highest member of the naturally occur-
ring elements, possesses a number of chemical
and physical properties which make it of po-
tential interest for non-nuclear military applica-
tions. These properties derive from its high
density, its pyrophoricity and its great tendency
to form useful alloys with other elements. At
the same time, the emergence of U as the pri-
mary nuclear expl dominates all other considera-
tions. As a nuclear expl, it has found application
in the generation of ultra-high shock pressures
(Refs 28 & 31) for the study of the properties
of matter in that regime

U is a member of the actinide series of ele-
ments which, together with the rare earths and
the transition elements, possess a high heat of
oxidation, a low oxide density compared with
that of the metal, and the presence of an unfilled
d shell in its electronic structure. While the
reasons for the high pyrophoric potential of U
are not clearly understood, they are thought to
be related to these aforementioned properties
(see under "Pyrotechnics" in Vol 8, P511 and
"Pyrophoric Incendiary Agents", P503-L)

U is a ubiquitous element. Th, U and its
decay product (see Table 2), Pb, are present in
igneous rock to a greater extent (11.4, 4 and
16g/ton, respectively) than any other heavy

metal except W (Ref 1). Igneous and meta-
morphitic rocks constitute 95% of the weight of
the outer 16 km of the earth's crust. The pre-
sence of U in granite pegmatites can be rationa-
lized by applying the geochemical principles of
Goldschmidt (Ref 1). According to his views,
as the molten earth cooled, elements possessing
the most stable oxides were concd in the litho-
sphere (crust). This explains why oxides of U are
found with those of Th, Ta, Nb, Zr, Hf and the
rare earths. Many secondary reactions occurred
after the primary deposition of the ores from the
magma. Aq extracts at high pressures, for in-
stance, result in "hydrothermal" vein deposits
(pitchblende) which also contain Cu, Bi, Ag,
Au, and Sn. Therefore, uranite ore (carnotite,
 UO_2) is found only in feldspar deposits with
significant quantities of Th and rare earths.
Pitchblende (U_3O_8) contains no Th and only
traces of the rare earth

Although U is not a rare element, relatively
few deposits are found which are worth working.
The most important sources are those at Great
Bear Lake in Canada, Katanga in Zaire, Jachymov
(joachimsthal) in Czechoslovakia, and the region
between Colorado and New Mexico. The high
concn of U in petrified wood suggests the
possibility that microorganisms may play a part
in the concn of U from dilute solns (Ref 1).
U is also found in the Soviet Union where there
are sources in Karelia, near Dnepropetrovsk, the
Kirghiz Soviet Republic and in Transcaucasia

Whereas once U ores were processed for their
Ra content, Ra has now lost its commercial
importance and it is considered a contaminant.
Only two U ores have been processed extensively,
pitchblende and carnotite. The general proce-
dure is to solubilize the U with an acid, convert
the ion to a complex carbonate (thereby remov-
ing the Fe, Al and Mn), ppt the Pb and Cu as the
sulfide, and finally, to recover the U as the am-
monium uranate and hence, as the oxide

U metal can be obtained from the oxide or
the halide by reduction with alkali metals or
alkaline earth metals. U, being highly electro-
positive, cannot be deposited electrolytically
from aq solns. Thermal decompn of the tetra-
iodide is possible (Ref 1)

The thermodynamic properties of U are
shown in Table 1 (Ref 19). The boiling point is
given to be $4407^\circ K$ and the vapor pressure at
 $2000^\circ K$ is reported to be 1.75×10^{-7} atm

Table 1
Thermodynamic Properties of Uranium (from Ref 19)

T, °K	Condensed Phase				Gas Phase, U (g)			
	C _p	H _T -H _{st}	S _T -S _{st}	G _T -H _{st} T	C _p	H _T -H _{st}	S _T -S _{st}	G _T -H _{st} T
298.15	6.61	0	0.00	12.02	5.663	0	0.000	47.724
400	7.10	698	2.01	12.28	5.724	582	1.677	47.947
500	7.65	1434	3.65	12.80	5.665	1151	2.913	48.370
600	8.31	2231	5.10	13.40	5.593	1714	3.975	48.842
700	9.08	3099	6.44	14.03	5.559	2271	4.834	49.313
800	9.99	4050	7.71	14.66	5.580	2828	5.577	49.766
900	11.02	5103	8.94	15.29	5.658	3389	6.238	50.197
941 (α)	11.47	5563	9.44	15.55	5.704	3622	6.491	50.366
941 (β)	10.26	6230	10.15	15.96	5.789	3961	6.841	50.604
1000	10.26	6836	10.78	16.29	5.866	4241	7.114	50.791
1048 (β)	10.26	7327	11.26	16.68	5.964	4549	7.401	50.990
1048 (γ)	9.15	8464	12.34	17.39	6.172	5155	7.928	51.356
1100	9.15	8939	12.78	18.05	6.404	5784	8.431	51.706
1200	9.15	9854	13.58	18.66	6.652	6436	8.915	52.041
1300	9.15	10769	14.31	18.69	6.664	6469	8.939	52.059
1400	9.15	11684	14.99	19.34	6.907	7114	9.382	52.364
1405 (γ)	9.15	11730	15.02	19.34	6.907	7114	9.382	52.364
1405 (δ)	11.45	13766	16.47	20.00	7.116	7880	9.911	52.720
1500	11.45	14854	17.22	20.60	7.346	8680	10.441	53.076
2000	(11.45)	(20579)	(20.51)	(22.24)	8.116	10880	11.541	53.825
2500	(11.45)	(26304)	(23.07)	(24.56)	8.999	15174	13.453	55.108
3000	(11.45)	(32029)	(25.15)	(26.50)	9.573	19827	15.148	56.263
3500	(11.45)	(37754)	(26.92)	(28.15)	9.984	24720	16.656	57.317
4000	(11.45)	(43479)	(28.45)	(29.60)	10.328	29800	18.012	58.286
4407	(11.45)	(48139)	(29.56)	(30.66)	10.572	34054	19.025	59.022
4500	(11.45)	(49204)	(29.80)	(30.88)	10.622	35040	19.246	59.184
5000	(11.45)	(54929)	(31.00)	(32.04)	10.836	40408	20.377	60.020

$$T_{\alpha \rightarrow \beta} = 941^{\circ}\text{K} \quad \Delta H_{\alpha \rightarrow \beta} = 667 \quad \Delta S_{\alpha \rightarrow \beta} = 0.709$$

$$T_{\beta \rightarrow \gamma} = 1048^{\circ}\text{K} \quad \Delta H_{\beta \rightarrow \gamma} = 1137 \quad \Delta S_{\beta \rightarrow \gamma} = 1.09$$

$$T_m = 1405^{\circ}\text{K} \quad \Delta H_m = 2036 \quad \Delta S_m = 1.45$$

Units: C_p, cal/moleK - H, cal/mole - G, cal/mole - S, cal/moleK

Table 2
Decay History for the Uranium-Radium Family

${}_{92}\text{U}^{238}$ (α) 4.5×10^9 y	\rightarrow	${}_{90}\text{Th}^{234}$ (β) 24.1d	\rightarrow
${}_{91}\text{Pa}^{234}$ (β) 1.1m	\rightarrow	${}_{92}\text{U}^{234}$ (α) 2.5×10^5 y	\rightarrow
${}_{90}\text{Th}^{230}$ (α) 8×10^4 y	\rightarrow	${}_{88}\text{Ra}^{226}$ (α) 1620y	\rightarrow
${}_{86}\text{Rn}^{222}$ (α) 3.8d	\rightarrow	${}_{84}\text{Po}^{218}$ (α) 3.05m	\rightarrow
${}_{83}\text{Bi}^{214}$ (β) 19.7m	\rightarrow	${}_{84}\text{Po}^{214}$ (α) 1.6×10^{-4} m	\rightarrow
${}_{82}\text{Pb}^{210}$ (β) 22y	\rightarrow	${}_{83}\text{Bi}^{210}$ (β) 5d	\rightarrow
${}_{84}\text{Po}^{210}$ (α) 140d	\rightarrow	${}_{82}\text{Pb}^{206}$ stable	

U, being dense and capable of being strengthened by alloying, has been utilized for applications other than nuclear such as radiation shielding, penetrators, incendiary munitions and aircraft counter weights (Refs 4, 6, 9, 11 & 16). The metallurgy of U has been extensively investigated and surveyed (Refs 7, 12, 13 & 25)

U, being a heavy metal, is inherently toxic. The handling of U does not usually present a problem except, perhaps, for personnel manufg U contg components for shielding or penetrators. The principle concern is with the radiological hazard which is associated with the ore, the natural element and the contaminated metal encountered in fuel recycling. Whereas naturally occurring U, chiefly U^{238} , has an extraordinarily long half life (4.51×10^9 y), the decay products (Pa, Rn, Ra) have accumulated in geologically long time frames and give rise to a significant hazard. The decay scheme for U^{238} is shown in Table 2. During the early 1970s several large studies were undertaken to assess the probable environmental effects of continued and accelerated reliance on nuclear power sources (Refs 20 & 23). Since, however, this projected commercial development did not take place, and as no updated studies have been undertaken, the status of the actual environmental hazard is somewhat uncertain

The time required for attainment of equilibrium in natural U and U ores which are not subject to leaching, is approximately one million years. The isotopic abundance is 99.28% U^{238} , 0.0057% U^{234} and 0.71% U^{235} . The activity of U^{238} is $334.8 \mu\text{Ci/kg}$. At equilibrium, each daughter will have the same activity giving rise to an activity of $2678 \mu\text{Ci/kg}$ (U) for the eight alpha emitters, and $2000 \mu\text{Ci/kg}$ (U) for the five beta emitters. Eighty-five percent of this activity will end up in the mill waste and it is the source of the principle toxicological concern (Ref 23)

Studies of the long term consequences of exposing the ground surface to natural and depleted U which is dispersed during expls tests has been investigated at the Los Alamos Scientific Laboratory and at Eglin Air Force Base (Ref 27). Soil samples at LASL were selected for an intensive study of U redistribution during the 33-year history of the use of this test site. The highest surface soil (0–2.5cm depth) concns occurred 0 to 10m from the detonation point and averaged 4500ppm. Concns in surface soil 50 to 200m from the firing point was less than 700ppm. At depths of up to 30cm U showed up to a significant degree. At a distance of 2.8km the U concn was about twice the background concn. The total quantity of U expended in this manner during the years from 1943 to 1973 was 64400kg. The principle mechanism for U transport was by surface water drainage over a terrain where water flow is sparse and highly seasonal (Ref 27)

There has been for many years a growing conviction that radiation emitted by radon inhaled for long periods or emitted from radioactive deposits in the lungs will cause bronchogenic carcinoma (Ref 22). This opinion is based on the fact that primary carcinoma of the lung accounted for about 50% of the deaths of miners at Joachimsthal, a finding known in the Middle Ages when miners' wives often were married 5 or 6 times. Respiratory cancer, not surprisingly, also afflicts miners of the base metals, Fe, Au, Zn and fluorspar. It is now known that the risk of pulmonary disease is markedly reduced by ventilation in the mines (Ref 22)

Separation of Uranium Isotopes

Unlike fossil fuels, U must undergo complicated processing. An essential step which accounts for about 30% of the total fuel cost is the enrichment of the newly mined U from its natural concn of 0.7% U^{235} to 2–4% for power applications, and to much higher concns for use as an expl (see Fig 1). Two processes will be briefly described, the gaseous diffusion process which is the original one and the one used mainly in the USA for the production of all enriched U, and the high speed centrifuge process which is favored in Europe and which is thought to be more economical in terms of energy requirements

The separative capacity of a diffusion stage

operating at a low and high pressure of p_b and p_f respectively on a molar flow rate of L is:

$$\Delta U = 0.480L(1-p_b/p_f)^2(\alpha - 1)^2 \quad (1)$$

where α is the corrected separation factor $(M_2/M_1)^{1/2}$, M_2 and M_1 being the molecular weights of the isotopic compds. For the U hexafluoride (the only practical gaseous U compd) the limiting separation factor is small, 1.00429. Thus $\alpha-1$ is small and L must be large in order to achieve a given overall separation. The capacity is improved by a large pressure differential, necessitating much pumping and cooling per stage, consuming much power. Consequently, gaseous diffusion plants tend to be large. The design of the US plants has been published (Ref 18)

The current gas centrifuge process goes back to a study by Gernot Zippe (Ref 5). According to theory, the maximum separative work which a gas centrifuge can produce per unit time is:

$$\Delta U = \frac{\pi Z c D}{2} \left(\frac{\Delta M V^2}{2RT} \right)^2 \quad (2)$$

where ΔU = separative capacity per stage (moles/unit time)

Z = length of centrifuge

c = molar density

D = diffusivity of process gas

ΔM = mass difference between the isotopic compds

V = peripheral velocity of the centrifuge

T = Temperature

R = gas constant

It will be noted that the separation effect is proportional to the mass difference compared with the quotient for gaseous diffusion. The centrifuge equation indicates the desirability of operating at low temps with long bowls at high speeds. G. Zippe, with a centrifuge 30cm in length rotating at a peripheral speed of 350m/sec at 33°C, obtained separation factors of 1.1–1.2 compared with a maximum of 1.004 for diffusion. Thus, only relatively few centrifuges need be connected in series to achieve substantial changes in concn. But, because flow rates attainable in centrifuges are much lower than in diffusion stages, large numbers of centrifuges operating in parallel are required (Ref 21)

Power consumption of a full size diffusion plant is required to operate it. A centrifuge

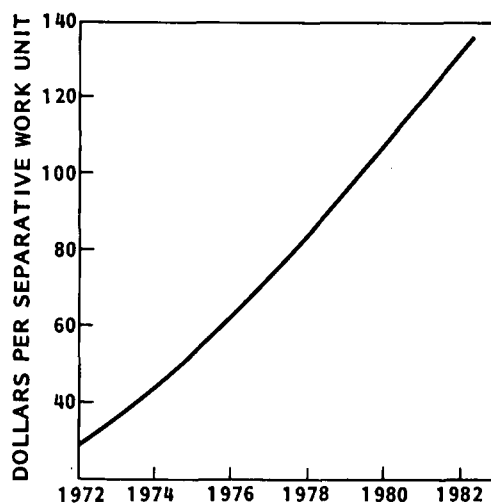

Fig 1 Price Structure of Enriched Uranium (from Ref 32)

operation of similar capacity consumes only 10% to 15% as much power so that as power costs increase, the cost difference between the two processes looms ever larger

The demand for U has fluctuated during the last two decades, whereas the price for enriched U, with small interruptions, has seen a steady increase (Ref 32). Fig 1 shows the price of 3% enriched U in terms of "separative work units" of which approx four are required to produce one kilogram of enriched U fuel. The sixfold price increase during the last decade is, no doubt, related to the steep increases in power costs associated with the US diffusion process, prompting a search for alternatives. Canada has initiated the design of the CANDU nuclear reactor which uses deuterium oxide to moderate natural U, circumventing thereby the problem of enrichment, albeit at the expense of managing large quantities of heavy water

Reactor Fuel Cycles

The source of energy in the nuclear fuel cycle is the neutron induced fission of U or Pu in a nuclear reactor or expl device, each fission releasing about 200Mev and several neutrons. The useful fissile isotopes are U^{235} , U^{233} and Pu^{239} , although only U^{235} is naturally occurring to the extent of about 0.7% of the natural U. The other fissile isotopes can be bred by neutron capture:

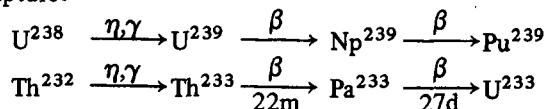

These fuel cycles are but two of many which offer resource extension because U^{238} and Th^{232} are common in nature. A breeder reactor is one which by such processes produces more fissile material than it consumes. All nuclear reactors depend in some way on a reprocessing facility. There the Pu and U would be separated, typically by an ion exchange process, from the fission products and from each other. The waste product stream, containing the radioactive fission products, must then be concd and stored in holding facilities. The inevitability of loss of containment before safe decay of the activity has prompted the current search for acceptable methods of disposal. Incorporation in a solid matrix (as in borosilicate glass), storage in subterranean cavities, etc, has attracted most attention

Nuclear power is the major component in the future energy supply plans of the world's major powers. In addition to offering abundant power, nuclear energy raises the potential for contributing to the acquisition of nuclear weapons by nations and by terrorists. The above breeder cycle schemes show that no special sophistication is required for obtaining, by an inexpensive chemical route, fissile material of sufficient purity and quantity for the production of weapons. One source of concern is the widespread deployment of isotopic enrichment technologies, such as gas centrifuges (see above). Another arises from the anticipated shift to Pu fuels. Fissile materials which can be used to make nuclear expls are present in all fuel cycles. Fig 2 shows the surprisingly small quantities of fissile material which constitutes a critical mass, considering that the amount of fissile material present in commercial power plants is many times greater than the amount required to make expls

Organizations which wish to develop weapons could use such commercial power plants as a cover for the time and labor consuming phase of a weapons program, the acquisition of weapons grade fuel. The scale of a weapons program fed by fissile material from a commercial fuel cycle could be much greater than one which derives from a weapons systems facility. Many countries have moved very close in time and skill to weapons without having to acknowledge the appropriate political decisions. The transition to a credible weapons status can take place within days or weeks. This "latent" proliferation al-

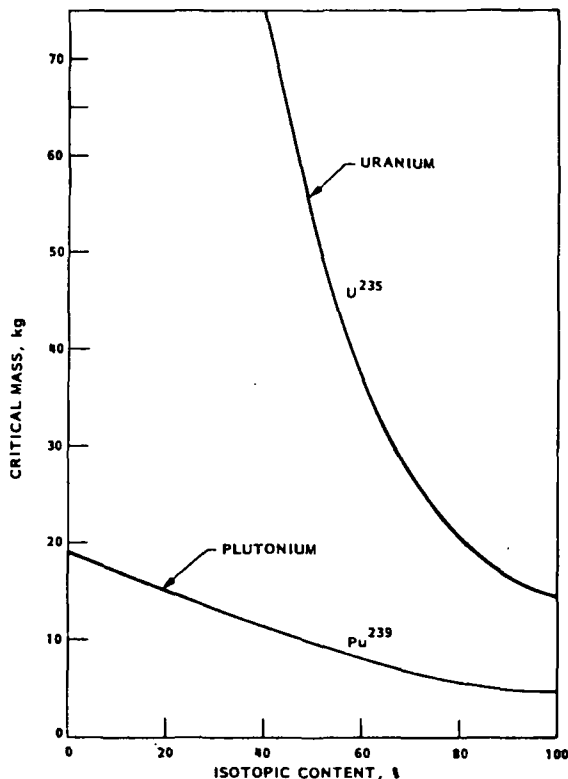

Fig 2 Critical Masses of Uranium and Plutonium (Data from Ref 24 as cited in Ref 29. The rapid increase in its critical mass makes isotopically dilute U unusable as an expl. This is not true for Pu, making it a greater proliferation hazard)

ready has had adverse effects in international affairs and the potential of access to nuclear expls may play into the hands of terrorists. The yield of primitive weapons is not relevant as long as their existence is credible. On the other hand, there is no credible preventive. As with commercial nuclear power, society must accept a measure of risk and be willing to mete out assured retaliation for breach of obligations (Ref 29)

Non-Nuclear Applications of Uranium

Depleted U (DU) has been used as a pyrophoric spark generator for spotting rifle projectiles (Ref 16) by adding 50 wt % of 20–60 mesh DU particles to mixts of $KClO_4$, $Ba(NO_3)_2$, or NH_4NO_3 and Al:Mg alloy. "Kinetic Energy Penetrators" were developed for the US Air Force rapid fire gun (GAU 8/A) from DU alloyed with 0.75% Ti (Ref 26). It was found that such

low Ti alloys imparted significant corrosion resistance to U so that cladding was not required (Ref 26), whereas extensive studies of the corrosion resistance of U in moist nitrogen and moist air were performed as well (Ref 25). It was found that corrosion resistance was profoundly affected by the microcrystalline structure of DU, the most corrosion resistance being attained when the DU was hot worked between 1500° and 1550°F, and the least when the hot work took place between 1150° and 1200°F

The ignition of U fragments has likewise been the subject of extensive investigation (Refs 2, 3 & 15). It was found that ignitability is affected by particle size and shape, that data can be correlated in terms of specific surface area, but that environmental factors arising from shock heating, etc, are not clearly understood. Self-heating may take place for considerable periods before the occurrence of ignition, although self-heating is not necessarily the preliminary to ignition. Inter-metallic compds of U such as UBi, UBi₂, U₃Sn₄, U₃Sn₅, UPb and UPb₃ are pyrophoric as fragments

The ignition temp as function of specific area(s) is given by the following expression (Ref 15)

$$\frac{C_p}{s} \cdot \frac{dT_m}{dt} = BA \exp(-Q/RT_m) - Q' \quad (3)$$

where s = specific area, a/m, m²/g

Q = 54–104 kjoules in air

Q' = heat lost by convection and radiation

T_m = metal temp, °K, and

A+B are constants

U is a powerful reducing agent and it reduces all metallic oxides except CaO, BeO and ThO₂; Al₂O₃, Li₂O and MgO are reduced at high temps. U is more reactive than Th. It reacts with air even at room temp, the oxide film being adherent and protective. Heating the massive metal in air can bring about ignition, usually above 700°C. Below 600°C steam is more corrosive than air, although many alloys have been prepared which impart corrosion protection to U (Refs 25 & 26). U reacts with water, especially gas-free water, the activation energy for hydrogen soaked water being about 18kcal/mole, typical corrosion rates being 1 g/cm²/hr at 230°C and 10⁻⁴ g/cm²/hr at 50°C. Nitrogen does not react with U below 300°C and can be used as a protective atm. U reacts readily with hydrogen,

even at ambient temps in powder form. There is little reaction at low temps in CO₂ but above 350°C the reaction becomes rapid with ignition above 800°C in dry gas, and at even 300°C when the gas is moist and contains oxygen. U is attacked by acids, but not by alkalis, unless an oxidizer is present (Ref 25)

Nuclear Rocket Engines

The fall from grace of U for power generation is paralleled by the history of nuclear rocket propulsion. In the 1960s several concepts were actively being investigated (Refs 14 & 17). Nuclear rocket engines could be categorized by the physical state of the fissionable fuel. Solid core engines involve no drastic departure from the state-of-the-art heat exchanger design because the nuclear fuel is immobile and imbedded within a solid. Performance of a solid-core engine is determined by the maximum temp of the fuel element. In principle, a gaseous fuel engine could raise the propellant (ie, hydrogen) to temps above the temp attained in solid fuel cores. Specific impulse values as high as 2500sec have been projected compared with 800sec for a solid core engine. The problems associated with gaseous nuclear rocket engines are chiefly those of materials compatibility as temps of 11000°K and pressures of 500atm were considered (Ref 10)

Thermodynamic Properties of Uranium Compounds

The thermodynamic properties of the common high temp reactions with U are shown in Table 3 (Ref 8)

Shock Properties of Uranium and its Alloys

Considerable effort has been devoted to the determination of the shock Hugoniot data which were recently published (Ref 30). These are reproduced for both U and several of its alloys in Table 4

Military Specifications for Uranium Alloys

Two US military specifications currently exist for U alloys: "Uranium Alloy for Body Section Center of Ammunition Components", MIL-U-46126 (28 June 1968), and "Uranium Alloy, Wrought, Bars, Billets and Tubular Shapes", MIL-U-46045C (24 June 1974)

Written by A. P. HARDT
Lockheed Missiles and Space Company

Table 3
Thermodynamic Properties of Uranium Compounds (from Ref 8)

Compound	H_{298}° kJ/mole	S_{298}° J/mole/K	M.P. °K	B.P. °K	H_M kJ/mole	H_V kJ/mole	Density g/cm ³
UO ₂	-1084.5	77.95	3000	—	—	—	10.96
U ₃ O ₈	-3571.0	276.1	1950 (d)	—	—	—	8.30
UO ₃	-1220.0	98.6	925 (d)	—	—	—	7.29
UF ₄	(-1853.5)	151.2	1309	1690	23.85	240.6	6.70
UF ₆	-2163.1	227.8	337 (subl)	—	47.82 (subl)	—	4.68
UO ₂ F ₂	- 269.9	135.5	—	—	—	—	—
UCl ₃	- 891.2	158.9	1108	2000	37.66	171.5	5.44
UCl ₄	-1051.0	259.4	863	1060	43.09	138.1	4.87
UCl ₅	(-1096.6)	(259.4)	600	800	35.56	(75.3)	3.81
UCl ₆	(-1139.7)	285.8	452	550	(20.92)	(46.0)	—
UOCl ₂	-1095.0	138.3	—	—	—	—	—
UO ₂ Cl ₂	-1255.2	150.5	—	—	—	—	—
UBr ₃	(- 711.3)	(205.0)	1025	(1840)	46.02	188.3	6.53
UBr ₄	(- 820.0)	(242.7)	792	1039	30.12	129.7	5.35
UOBr ₂	-1033.0	157.6	—	—	—	—	—
UI ₄	(- 531.4)	(272.0)	779	1032	62.76	128.4	5.6
UC	- 179.9	(64.4)	2550	—	—	—	—
UN	- 334.7	(75.3)	2900	—	—	—	14.31

() estimated value, (d) decomposes, (subl) sublimes

Table 4
Shock Hugoniot Data for Uranium and Its Alloys

Material, wt % data	Shock Velocity, U_s km/s	Density, ρ_0 g/cm ³	Grueneisen constant, γ
U	2.51 + 1.51 u_p	18.930	—
U + 2% Mo	3.35 + 1.12 u_p	18.580	—
U + 3% Mo	2.56 + 1.54 u_p	18.447	2.03
U + 8.3% Mo	2.66 + 1.51 u_p	17.312	—
U + 4.7% Nb	3.11 + 1.24 u_p	17.650	—
U + 6% Nb	2.56 + 1.56 u_p	17.411	—
U + 1% Rh	2.56 + 1.50 u_p	18.825	—
U + 5.4% Rh	2.67 + 1.49 u_p	18.326	—
U + 13.4% Rh	2.74 + 1.49 u_p	17.204	—
U + 0.6% Ti	3.03 + 1.27 u_p	18.650	—
U + 2.5% Nb + 1.3% Ti	3.32 + 1.13 u_p	17.750	—

- Refs: 1) J.J. Katz & E. Rabinovich, "The Chemistry of Uranium", Part 1, McGraw Hill, NY (1951), 70 2) J.T. Weber, US Atomic Energy Comm Rept **LA 1524** (1952) 3) B.R.T. Frost & J.T. Muskrey, *JIM* **82** (1), 171 (1953) 4) H.W. Nelson & R.L. Carmichael, "Potential Non-Nuclear Uses for Depleted Uranium", US AEC **TID 8203** (1960) 5) G. Zippe, "The Development of Short Bowl Ultra-Centrifuges", **EP-4420-101-60V**, Univ of Virginia (1960) 6) G.D. Chandley, D.G. Fleck & B.W. Crocker, "Spotting Rounds, First Success with Cast Uranium", *ModCast* **40**, 41-44 (1961) 7) Anon, "Uranium Alloys for Critical Ordnance Components", **WAL-MS-19**, Watertown Ars Labs (1961) (AD 609896) 8) C.E. Wicks & F.E. Block, "Thermodynamic Properties of 65 Elements: Their Oxides, Halides, Carbides and Nitrides", US BuMines Bull **605** (1963) 9) M.S. Farkas, "Review of Uses for Depleted Uranium and Non-Energy Uses for Natural Uranium", **DMIC Memo 165**, Battelle Mem Inst (1963) 10) K.O. Kessey & R.A. Gross, *AIAAJ* **2** (8), 1461-64 (1964); also see: K. Thom et al, "Physics and Potentials of Fissioning Plasmas for Space Power and Propulsion", *Acta Astronautica* **3**, 505-16 (1976) 11) C.W. Semple, "High Density Alloys for Shell Fragments", **AMRA-TR-64-46** (1964) (AD 461787) 12) H.P. Tardif, "The Heat Treatability and Properties of Uranium Alloys", *Canadian Mining & Metallurgical Bull* (Nov 1965), 1167 13) S.M. Wolf & F.J. Rizzitano, "Properties of Several Structural U-Mo-Cb-V-Ti Alloys", **TRAMRA 67-18** (1967) 14) L.F. Donovan et al, "Heat and Mass Transfer Characteristics of an Axial Flow Liquid Core Nuclear Rocket Employing Radiation Heat Transfer", *NASA TND 4127* (1967) 15) R.J. Pearce, "Ignition of Uranium", **RD/B/N 1134**, Berkeley Nuclear Labs (1968) 16) T. Stevenson, "Depleted Uranium Pyrotechnic Compositions for Spotting Rifle Projectiles", *USP 3389027* (1968) 17) T.S. Latham, "Nuclear Studies of the Nuclear Light Bulb Rocket Engine", **NASA-CR-1315** (1969) 18) Anon, US AEC Comm Rept **ORO-658** (1968) & **ORO-668** (1969) 19) R. Hultgren et al, "Selected Values of Thermodynamic Properties of Metals and Alloys", Supplements, Univ of Calif (1970) 20) Anon, "Environmental Analysis of the Uranium Fuel Cycle", Part 1, Fuel Supply (Oct 1973) (PB-235804); *Ibid*, Part 2, Nuclear Power Reactors (Nov 1973) (PB-235805); *Ibid*, Part 3, Nuclear Fuel Processing (Dec 1973) (PB-235806) 21) R.H. Perry & C.H. Chilton, Eds, "Chemical Engineer's Handbook", 5th Ed, McGraw Hill, NY (1973) 22) F.T. Cross et al, "Evaluation of Methods for Setting Occupational Health Standards for Uranium Miners", Battelle-Pacific Northwest Laboratories (1974) (PB-237744) 23) R.S. Kerr, "State of the Art - Uranium Mining, Milling and Refining Industry (1974) (PB-235557) 24) T. Taylor, *AnnRevNuclSci* **25**, 407 (1975) 25) S. Orman, "Oxidation of Uranium and Uranium Alloys", in J.J. Burke et al, Eds, "Physical Metallurgy of Uranium Alloys", Brookhill Publ Co (1976); also see: J.C. Bailer et al, Eds, "Comprehensive Inorganic Chemistry", Vol 5, Pergamon Press, Oxford (1973), 40-42 26) L.J. Weirick, "Corrosion Testing of the General Electric Mantech Gau 8/A Penetrator", **SANDIA 76-8055** (1977) 27) W.C. Hanson & F.R. Miera, Jr, "Continued Studies of Long Term Ecological Effects of Exposure to Uranium", **AFATL-TR-77-35** (1977) (ADA 061727) 28) C.E. Ragan II, "Shock Compression of Molybdenum to 2.0TPa by Means of a Nuclear Explosion", *JApplPhys* **48**, 2860-70 (1977) 29) E.J. Moniz & T.L. Neff, "Nuclear Power and Nuclear Weapons Proliferation", *Physics Today* (April 1978), 42-51 30) S.P. Marsh, "LASL Shock Hugoniot Data", Univ of Calif Press, Berkeley (1980) 31) C.E. Ragan II, "Ultra High Pressure Shockwave Experiments", *Phys-RevA* **21** (2), 458-63 (1980); see also: "Hugoniot Measurements Near 50MBar", in Vodar & Marteau, Eds, "High Pressure Science and Technology", Pergamon Press, NY (1980) 32) A.J. Large, "Why the Price of Atomic Fuel Keeps Rising", *Wall Street Journal* (July 2, 1981), 25 33) Anon, "US Nuclear Regulatory Commission Rules and Regulations, Title 10", Chapt 1 (March 27, 1981), p 20-18

Uranium Compounds

Uranium Borohydride [Uranium (III) tetrahydroborate]. $U(BH_4)_3$; mw 282.58; green pyrophoric crystals, volatile at RT; mp $>70^\circ$ (22mm Hg); bp, explds on heating. Reacts with water and methanol. Prepn is by reacting U (IV) fluorides with an excess of Al borohydride

General Note on Toxicity: Sittig (Ref 5) considers U and its compds to be highly toxic by ingestion, inhalation, and/or radiation. The primary effects of ingestion are on the kidneys and liver. Dust inhalation can lead to chronic poisoning with prolonged exposure giving chest findings of pneumoconiosis, pronounced blood changes and generalized injury. Radiation effects are similar to those produced by ionizing radiation, ie, cancer of the lung, osteosarcoma and lymphoma

The US Federal permissible exposure limits are: U, soluble compds, $0.05\text{mg}/\text{m}^3$; U, insoluble compds $0.25\text{mg}/\text{m}^3$; according to NIOSH. ACGIH (1978) cites $0.2\text{mg}/\text{m}^3$ for both soluble and insoluble natural U compds

Refs: 1) Gmelin, Syst Nr 55 (1940) 2) H.I. Schlesinger & H.C. Brown, "Uranium Borohydride and its Alkyl Derivatives", in J.J. Katz & E. Rabinowitch, Eds, "Chemistry of Uranium—Collected Papers", TID 5290, Book 1, USAEC, TISE (1958), 145–46 3) K.N. Semenenko et al, "Covalent Tetrahydroborates", RussChem-Rev 42 (1), 1–13 (1973) & CA 78, 105441 (1973) 4) Bretherick (1979), 246 5) M. Sittig, "Hazardous and Toxic Effects of Industrial Chemicals", Noyes Data Corp, Park Ridge, NJ (1979), 437–38

Uranium Dicarbide. UC_2 ; mw 262.05; metallic crystals; mp $2350\text{--}2400^\circ$; bp 4370° ; d $11.28\text{g}/\text{cc}$ at 16° . Decompd by dil inorg acids, and v violently by w. Prepn is by heating a mixt of U oxide and sugar charcoal at 1370° in a C crucible by means of an electric furnace for 5 to 10 minutes. The compd emits brilliant sparks on impact, and ignites on grinding in a mortar or on heating in air to 400° . In particle sizes of less than 40 microns, it is spontaneously flammable. The dicarbide reacts with incandescence with halogens or N_2 above 300°

Refs: 1) Gmelin, Syst Nr 55 (1940), 159 2) Mellor 5 (1946), 890–01 3) H.S. Kalish & R.B. Holden, "Nuclear Fuel Research Fuel Cycle Development Program—Quarterly Progress Report for April 1 to June 30, 1960", NYO-2689, Olin Mathieson Chem Corp, New Haven, Contract AT-(30-1)2374 (1960), 15–17 4) E.G. Kayser & C. Boyars, "Spontaneously Combustible Solids—A Literature Survey", TES-20-75-1 (1975), 21 (PB 244046)

Uranium Hexafluoride (Uranyl hexafluoride). UF_6 ; mw 352.02; colorless, deliq monoc crystals; mp $64.5\text{--}64.8^\circ$; bp, subl at 56.2° ; d $4.68\text{g}/\text{cc}$ at 21° . Sol in liq Br, Cl_2 , C tetrachloride, sym-tetrachlorethane and fluorocarbons. Reacts with extreme violence with benz, ethanol, toluene, w or xylene. Prepn is by reaction of dried, powdered U_3O_8 with F gas above 600° . Product purification is by vac sublimation in a quartz appar. The vapor behaves as a nearly perfect gas. The compd has a ΔH_f of $2197.7 \pm 1.8\text{KJ}/\text{mole}$. It is used in the gaseous diffusion process for the sepn of U isotopes

Refs: 1) Gmelin, Syst Nr 55 (1940), 124–31 2) G. Brauer, "Handbook of Preparative Inorganic Chemistry", Academic Press, NY (1963), 262 3) CondChemDict (1977), 904–05 4) ChemRubberHndbk (1978), B-173 5) Bretherick (1979), 908 6) G.K. Johnson, "The Enthalpy of Formation of Uranium Hexafluoride", JChemThermodyn 11 (5), 483–90 (1979) & CA 91, 63538 (1979)
Addnl Refs not used above: A) R.A. Ebel et al, "Recovery of Uranium Hexafluoride from a Process Gas Stream by Absorption-Distillation Techniques Employing a Liquid Fluorocarbon Medium", K-1366, Union Carbide Nuclear Co, Oak Ridge, Contract W7405-eng-26 (1959) B) R. DeWitt, "Uranium Hexafluoride: A Survey of the Physico-Chemical Properties", GAT-280, Goodyear Atomic Corp, Portsmouth, Contract AT-(33-2)-1 (1960) C) L.S. Allen, "A Parametric Survey of Criticality-Limited Fast Reactors Employing Uranium Fluoride Fuels", TR32-198, Jet Propulsion Lab, Contract NAS-7-100 (1962) D) C.A. Geffen et al, "Assessment of the Risk of Transporting Uranium Hexafluoride by Truck and Train", Battelle, Richland, Contract EY-76-C-06-1830 (1978)

Uranium Hydride. UH_3 ; mw 241.05; blk-brn pyrophoric cubic crystals or powder; d 10.95; 11.42g/cc (separate values). Sl sol in dil HCl; insol in acet, ethanol and liq ammonia. Prepn is by passing H_2 over coarsely ground U at 250° ; the yield is quant. The hydride ignites spontaneously in air, and must be stored and handled under N_2 or CO_2 . It reacts very violently with w, and explosively with organic halides. The hydride is also violently attacked by halogens to form U halides

Refs: 1) Gmelin, Syst Nr 55 (1940) 2) D.T. Hurd, "An Introduction to the Chemistry of the Hydrides", J Wiley & Sons, NY (1952), 170–80 3) J.J. Katz & E. Rabinowitch, Eds, "Chemistry of Uranium—Collected Papers", TID 5290, Book 1, USAEC, TISE (1958), 141–44 4) G. Brauer, "Handbook of Preparative Inorganic Chemistry", Vol 2, Academic Press, NY (1965), 1434–35 5) J.R. Gibson & J.D. Weber, "Handbook of Selected Properties of Air and Water-Reactive Materials", RDTR 144, US Naval Ammo Depot, Crane (1969), 106–07 6) CondChemDict (1977), 904–05 7) ChemRubberHndbk (1978), B-173 8) Bretherick (1979), 989

Uranium Nitride. UN; mw 252.04; v pyrophoric brn powder; mp ca $2630 \pm 50^\circ$; d 14.31g/cc. Insol in hydrochloric or sulfuric acids. Prepn is by reaction of U hydride with ammonia at 250° . The finely divided powder is extremely pyrophoric in air at RT

Refs: 1) Gmelin, System Nr 55 (1940), 107 2) D.T. Hurd, "... Chemistry of Hydrides", J. Wiley & Sons, NY (1952), 180 3) ChemRubberHndbk (1978), B-173 4) Bretherick (1979), 1069

Uranium-Zirconium Alloy Explosions. An intermetallic compd, UZr_3 (mw 511.69), exists in which $\alpha\text{-U}$ and $\alpha\text{-Zr}$ have limited solid solubility. According to the ref, this solid soln is designated as the *epsilon phase*, and has approx lower and upper limits of 41 to 53 wt % Zr. Hence, lesser or greater fractions of finely divided epsilon phase exist in a matrix of $\alpha\text{-U}$. On treatment with nitric acid for the purposes of etching, dissolution or pickling of the U-Zr alloy, the $\alpha\text{-U}$

matrix is rapidly dissolved and the epsilon phase is slowly oxidized. This oxide is a solid soln of urania and zirconia in a mole ratio of approx 1/3. In the course of such acid treatment (or subsequent to), the unoxidized particles of the epsilon phase may undergo a rapid oxidation with expl violence. The addn of fluoride ion is recommended as a means of preventing such explns, this addn increasing the rate of soln of the minor phase

Ref: R.P. Larson et al, "A Study of the Explosive Properties of Uranium-Zirconium Alloys", ANL-5135, Argonne Natl Lab, Lemont, Contract W-31-109-eng-38 (1954)

Uranyl Acetate. $\text{UO}_2(\text{C}_2\text{H}_3\text{O}_2)_2 \cdot 2\text{H}_2\text{O}$; mw 422.19; yel rhomb crystals; mp 110° ($-2\text{H}_2\text{O}$); bp 275° (decompn); d 2.893g/cc at 15° . V sol in ethanol; sol in w. Prepn is by reacting Na acetate with U nitrate. The acetate has been suggested by DeMent (Ref 2) for use in a pyrot radioactive smoke formulation. The compn consists of U acetate 3, Na chlorate 8, S 4 and amm acid fluoride 4.5p, which upon ignition burns in a flameless reaction generating a grey smoke

Refs: 1) Gmelin, Syst Nr 55 (1940), 163–64 2) J. DeMent, USP 2995526 (1960) & CA 55, 25100 (1961) 3) ChemRubberHndbk (1978), B-173

Uranyl Boron Cobalt Perchlorate.

$[\text{UO}_2\text{BCo}](\text{ClO}_4)_2 \cdot x\text{H}_2\text{O}$; yel solid; mp, explds on heating. Prepn is by reacting Co perchlorate with uranyl boride in abs ethanol at RT

Ref: M. Vidali et al, "Uranyl Complexes as Chelate Ligands Toward Transition Metal Ions", JInorgNuclChem 37, 1715–19 (1975) & CA 83, 157119 (1975)

Uranyl Nitrate. See in Vol 8, N39-R to N40-L, and the following *Addnl Refs:* 1) J.D. Hopper, "... Study of Explosive Mixtures Containing Uranyl Nitrate", PATR 373 (1933) [This investigation reports on attempts to produce a HE compn for shell loading using the nitrate and Al powder. It was found that the optimum mixt of the ingredients, uranyl nitrate 15.2 and Al

7p, has a very high heat of reaction and an impact sensy of 12" using a 2-kg wt. However, the compn is only mildly expl under confinement, and does not compare with such standard expls as Tetryl or TNT] 2) R.J. Jackson & W.L. Johns, "Explosive Nature of Uranium-Base Niobium Alloys after Immersion in Nitric Acid", RFP-1575, Dow Chemical Co, Golden, Contract AT(29-1)-1106 (1970) & CA 75, 52253 (1971) [The expl behavior is related to a finely divided, 2-phase microstructure, and to a high C content. In the first instance, the nitric acid selectively attacks the alpha-U phase, leaving behind a finely divided Nb-rich gamma-phase which can oxidize with expl violence. In a second situation, Nb carbide inclusions accumulate at the surface and are likewise subject to rapid oxidation. It is reported, however, that the most violent explns occur with slow-cooled, slab-cast, high C alloys having a casting scale of UO and UO₂. It appears that the nitric acid dissolves the casting scale and leaves a reactive surface layer of finely divided gamma-U, Nb carbide, and the expl uranyl nitrate. When this layer (dry or wet) is struck or sparked, a violent decompn occurs which rapidly produces large quantities of gases and heat]

Uranyl Perchlorate. See in Vol 8, P169-R

Urate, Ammonium. Lansdorf, at the end of the nineteenth century, patented a Dynamite contg 75p NG which was absorbed by a mixt of 20p kieselguhr and 5p amm urate. He also patented a BlkPdr contg 75p K nitrate, 5p amm urate, 9p S and 9p charcoal

Ref: Daniel (1902), 403

p-Urazine. See in Vol 1, A272-L under "4-Aminourazole . . ." and the following *Addnl*

Ref: Anon, "Fire Protection Guide on Hazardous Materials", 7th Ed, Natl Fire Protection Assn, Boston (1978), 491M-437 [A brisant expln of the material while being manipulated in a glass container is reported. The expln is attributed to a possible nitrogen-contg by-product]

Urbański, Tadeusz (1901—). Polish Professor and organic chemist, best known as author of "Chemistry and Technology of Explosives" in 3 vols; Polish edn 1954-55; also in Czeck, Ger and Engl edns. Professor of organic chemistry, Tech Univ of Warsaw 1933-72; Professor Emeritus from 1972. Author of over 450 original papers and 50 review articles; holder of over 30 patents. Honors include: Natl Prizes for Sci Work, Poland 1949 and 1952; J. Sniadecki Medal of Polish Chem Soc, 1964; and Cmdr, Order of Polonia Restitute with star, 1971. Address: c/o Chemical Faculty, Technical University (Politechnika), 00-662, Warszawa, Poland

Ref: E. Kay, Ed, "Dictionary of International Biography", Melrose Press Ltd, Cambridge, Engl (1974), 1816-17

Urea (Carbamide, Carbonyldiamide, Aquadrate, Ureaphil or Ureophil). (NH₂)₂C:O, CH₄N₂O; mw 60.06; N 46.65%; colorl tetr prisms; develops the odor of ammonia, cooling (saline) taste. CA Registry No [57-13-6]

History. A product of protein metabolism, urea was first discovered in urine in 1773 by Rouelle and more fully investigated by Fourcroy, Vanquelin and Prout. In 1824 F. Wohler (1800-1882) heated an aq soln of amm sulfate and set it aside. Four years later in 1828 he examined the mixt and found in it crysts of urea (Ref 2). This prepn not only marked the first synthesis of urea, but also the first synthesis of an organic compd from inorganic materials. Prior to this discovery scientific thinking held that organic compds and compns could only be obtd from plants or animals, and that a "vital force" was necessary for their prepn. Since then many other methods of prepn of urea have been developed, and most of them are mentioned in Beil (Ref 1). Several of these procedures are worthy of discussion at this point. One of the first direct methods of prepn of urea was that of Basaroff (or Bassarow). He heated amm carbamate in sealed tubes between 130° and 140°, obtaining urea in good yields by dehydration (Ref 3). A rapid lab procedure was developed by Schmidt (Ref 4). It consisted of treating cold concd ammonia with an excess of carbon oxy-

sulfide (carbonyl sulfide or COS), followed by shaking the mixt with an aq suspension of Pb white (basic Pb carbonate) while filtering off the ppt and evapg the filtrate. Datta and Choudhury (Ref 4a) prepd pure urea in quant yield by evapg on a water bath the filtrate obtbd on interaction of the semicarbazide hydrochloride and Ag nitrite. Of the more than several industrial preps used in the early twentieth century two are of interest in this review. The first method consists of pumping ammonia and carbon dioxide into an autoclave where they are heated together under pressure while more of each gas is pumped in. The following reaction takes place:

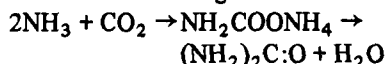

The second method is by action of carbon dioxide on Ca cyanamide suspended in water:

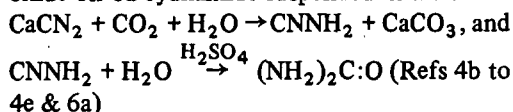

Preparation. The current basic comml procedure, the "once-through" process (Fig 1), uses liq ammonia and liq carbon dioxide at 1750 to 3000psi and 160–200°. These constituents react to form amm carbonate which is decompd at about 80psi to urea and w. Several variations of the process include a partial recycle process and, the most commonly used technique, the total recycle process. Fig 2 is a diagram of the latter process as adapted for use by the Chemical

Construction Corp (USA). According to Ref 13 the system is operated as follows, "... The urea synthesis reactor is operated at about 220 atm pressure, at about 190°C, and at an overall NH₃ to CO₂ molar ratio in the reactor of about 4 to 1. Under these operating conditions about 64–67% of the carbamate present in the reactor is converted to urea. The unconverted carbamate and the excess NH₃ are recovered in a two-pressure staged decomposition and recovery sections. See Figure 2. The first decomposition and absorption stage operates at about 20 atm pressure. The reactor effluent, let down in pressure from 220 atm is heated in the first decomposition stage at about 155°C to decompose and strip from the urea product solution most of the unconverted carbamate and excess NH₃. The recovered gas is cooled in the first absorption stage; all the CO₂ is reacted with the stoichiometric amount of NH₃ to carbamate and dissolved in water along with some of the excess NH₃. The remaining portion of the excess ammonia gas is separated from the aqueous carbamate solution, purified from the last traces of CO₂ in a bubble cap column, and condensed to liquid with cooling water. The liquid ammonia is recycled back to the reactor along with the stoichiometric amount of fresh makeup of NH₃. The recovered ammoniacal aqueous solution of ammonium carbamate, containing about 25 wt % of water, together with the stoichiometric amount of fresh gaseous CO₂

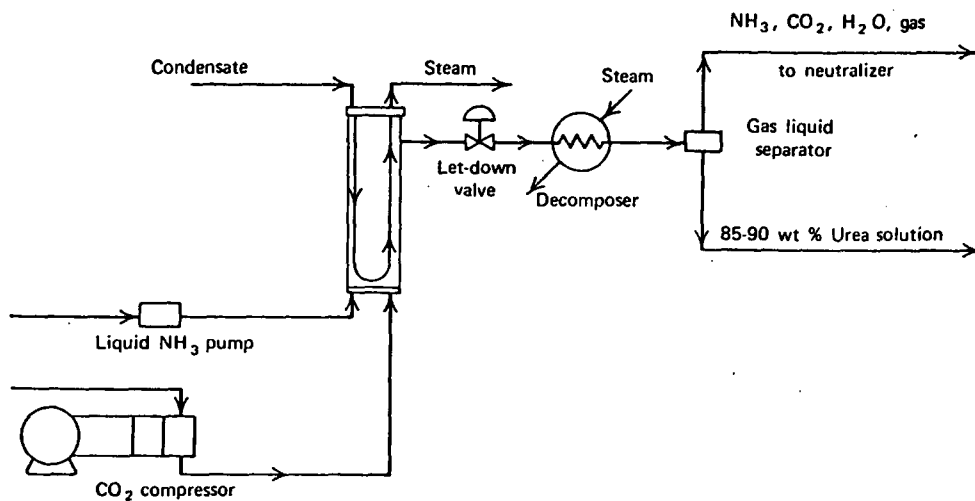

Fig 1 Once-Through Urea Process (Ref 13)

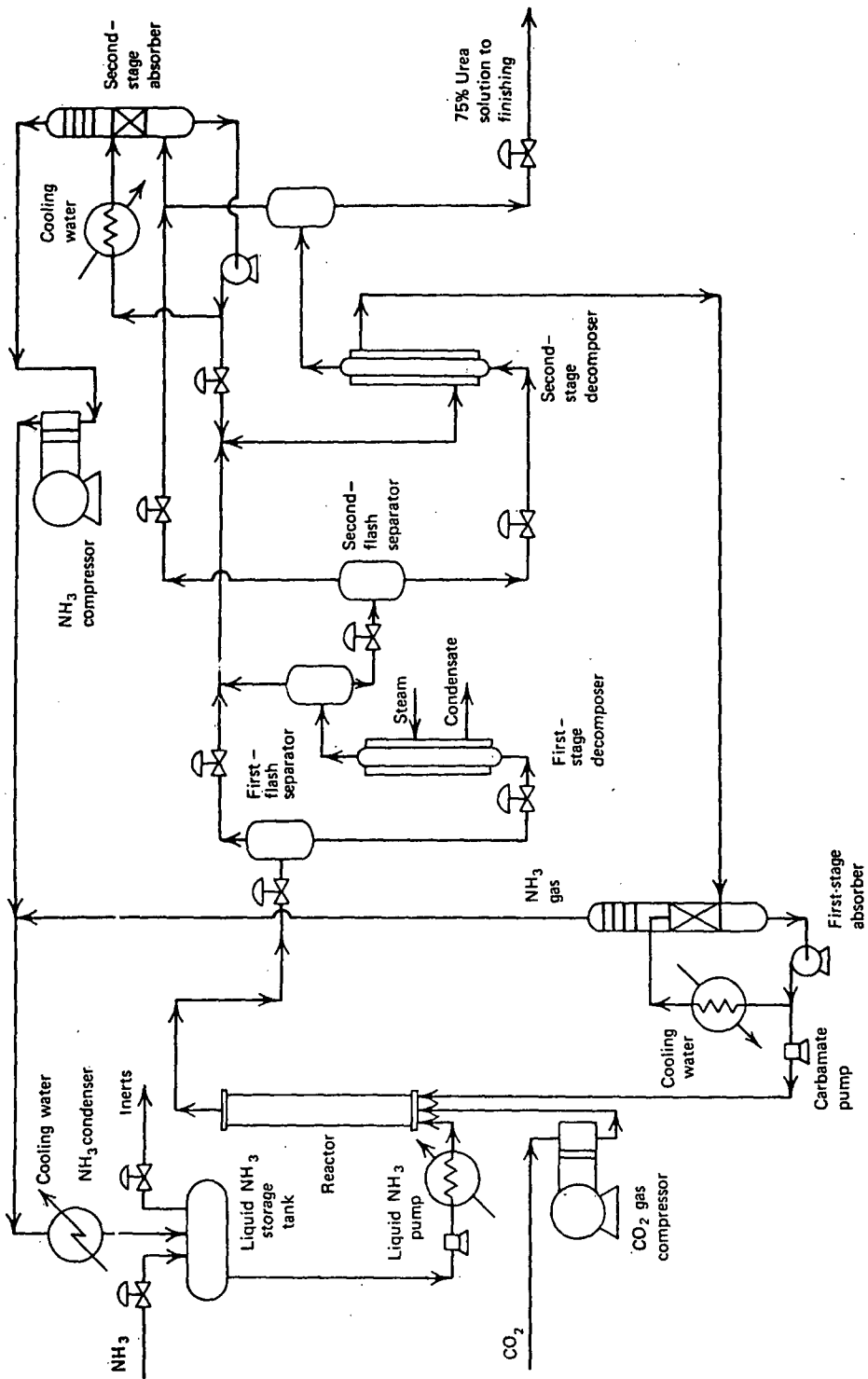

Fig 2 Chemico Total-Recycle Urea Process (Ref 13)

are introduced into the reactor.

The urea-product solution, leaving the first decomposition stage and still containing some unreacted carbamate and excess NH_3 , is let down in pressure and steam heated in the second-staged decomposition section, which operates at about 2 atm and 120°C . Practically all of the residual carbamate is decomposed and stripped from the urea-product solution together with the residual excess ammonia. The 74–75 wt % urea solution thus obtained is further processed to solid urea. . .

The NH_3 and the CO_2 gas, recovered from the second decomposition stage, is cooled in the second absorption stage where all the CO_2 is reacted to carbamate and dissolved in water along with some of the excess NH_3 . The solution thus obtained is pumped back to the first absorption stage and thence to the reactor for total recovery. Only part of the excess ammonia is dissolved in the solution recovered from the second absorption stage. The remaining portion of the excess ammonia gas is separated from the aqueous carbamate solution, purified from the last traces of CO_2 , in a bubble cap column, compressed to about 20 atm, condensed to

liquid with cooling water, and pumped back to the reactor. A tight overall water-balance control system, within the urea-synthesis section, ensures a relatively high conversion in the reactor. Heat is internally recovered in the second-stage decomposer by utilizing part of the heat of carbamate formation in heat exchange with the urea-product solution undergoing NH_3 and CO_2 degassing . . .”

However, these processes have been found to be dangerous in that explns have occurred for one reason or another. Attempts to eliminate traces of hydrogen in the gas stream (one cause of explns) have led to the use of a Pd catalyst (Ref 28). Other attempts to keep the gaseous mixt below the use of a gas-absorbing solvent (Ref 40). Standard precautions now include sufficient maintenance procedures to eliminate plugged weep holes and corroded piping and reactor shells (Ref 41)

Properties.

Chemical. Urea acts as a monobasic substance and forms salts with acids. In the presence of a strong base urea forms metal salts,

Table 1
Properties of Urea

Property	Value	Refs
Boiling Point, $^\circ\text{C}$	decompn	30a
Bulk density, g/cc	0.74	13
Cryst density, g/cc	1.3230	30a
Free energy of formation at 25° , cal/g-mole	-47, 120; 47, 131 (separate values)	5; 13
Heat of combstn, kg-cal/mole	150.97	5; 30a
Heat of crystn; 70% aq urea soln, cal/g	110 exothermic	13
Heat of fusion, cal/g	60 exothermic	13
Heat of soln, in w, cal/g	58 endothermic	13
Index of refraction, N_D^{20}	1.484; 1.602 (separate values)	13; 30a
Melting point, $^\circ\text{C}$	132.7; 135 $^\circ$ (separate values)	13; 30a

such as with Ag nitrate in the presence of NaOH to form (Ag)₂ urea. With alcohols, urea usually forms carbamic acid esters called urethanes. Urea reacts with formaldehyde and forms compds such as monomethylolurea, dimethylolurea, and others including urea-formaldehyde resins. The product depends upon the molar ratio of formaldehyde to urea and upon the pH of the reactant solns (Ref 13)

Physical. Again according to Ref 13, "... urea has the remarkable property of forming crystalline complexes or adducts with straight chain organic compounds. These crystalline complexes consist of a hollow channel, formed by the crystallized urea molecules; in which the straight-chain hydrocarbon is completely occluded. Such compounds are known as clathrates. The type of hydrocarbon occluded, on the basis of the length of its carbon chain, will be determined by the temperature at which the clathrate is formed. This property of urea clathrates is widely used in the petroleum refining industry for the production of jet aviation fuels . . . the clathrates are broken down by simply dissolving urea in water or in alcohol and by decanting the hydrocarbons from the urea solution . . ." (also see Refs 7 & 10)

Urea is v sol in ammonia, ethanol, benz (?), methanol and w; sl sol in eth; insol in C tetrachloride (Refs 13, 29a & 30a). Table 1 lists the general physical and physicochemical properties of urea

Uses

Explosives: Notably, urea has been used as a precursor along with AN in a synthesis of Nitroguanidine (see in Vol 6, G155-L). However, Anderson (Ref 9) points out that the handling of Urea-AN solns is dangerous since several explns have occurred in fabrication plants. In this area, Leach (Ref 38) reports that the facility-associated critical diameter for the mass detonation by expl shock of urea-AN reactants and products involved in the process for the manuf of Guanidine nitrate and Nitroguanidine are 1.5" for the reactor feed stream and 1" for the evaporator outlet. Use of urea as a fuel in expl compns includes the following: Phillips (Ref 6) reports on an expl compn which can be cast at 103° for use as a bursting charge for shells and bombs contg AN (60.5), Na nitrate (18.0), grade A Al

(1.0), grade B Al (10.0) and urea (10.5%), that has a drop test value of 38" (2-kg wt) and an expln temp of 294°. Urea along with Na chloride are used as antifreeze agents in expl gels invented by Arbie (Ref 8). A typical mixt is reported as contg AN (18.50), Na chloride (8.00), w (15.00), Na nitrate (17.78), TNT (35.00), polyamide (0.62), Al sulfate (0.10) and urea (5.00%). The inventor claims that the gels remained fluid for over 60 days at -15°F. Gordon (Ref 11) uses urea as a fuel along with Al and AN to provide a blasting gel with a deton rate of 9300ft/sec. Thus, AN (43.5), Na nitrate (14.0), guar gum (1.5), perlite (5.6), urea (8.7), w (added at bp) (23.2), flake Al (1.9), S (1.9) and Na borate (0.5%) are blended together to form the desired gel. Similarly, Jardin and Travers (Ref 14) suggest the use of urea as a fuel in a typical, insensitive-when-unconfined, compn: AN prills (74), Na nitrate (2), w (16), urea (5.5), guar gum (0.4), Zn chromate (0.1), and naphthalene (2.0%). Francis (Refs 15 & 16) claims the use of urea primarily as a crystallization inhibitor for compns which when detonated in 2" and 3" diam schedule 40 steel pipe, using from 10 to 25g of C-4 compn as the initiator, yielded deton velocities in the range of from 4663 to 6126m/sec. Typically, a mixt comprising urea (4), AN (21.3), guar gum (0.7), Na nitrate (19), ball powder (30), w (20) and Al powder (5%) forms a cohesive pourable blasting slurry. Forshey and Lisotto (Ref 18) suggest the use of urea as a synergistic stabilizer in their patented series of cap-sensitive gels. For example, a mixt of AN (43.7), Na nitrate (3.5), w (30), Na chloride (10), Al flakes (8), K dichromate (1), urea (0.3), guar gum (2.5), sugar (0.7), and a 1:20 Na hydroxide/K hydrogen phosphate mixt (0.3p) yields a gelled blasting agent of d 1.29 g/cc, having a deton velocity of 3500m/sec, a TNT equivalency value of 77%, a 3.5" air gap sensy, and a 06 electric blasting cap sensy. After 1.5 years of storage the inventors report no sensy change, gas evoln or swelling, and minimum syneresis

In Mason and Forshey's invention (Ref 19) 0.25 to 2.0% powdered urea is added to act as a base in order to neutralize any acid formed in a typical AN-fuel expl compn, which causes decompn of the mixt above 250°F. To illustrate their claim, the inventors made a comparison of

the decompn temps of dry, wet, and acidified compns before and after urea addn. Thus, a 90:10 AN-6% fuel oil/pyrite oil mixt, as compared to the std compn plus 5% w, and a std compn plus 5% acid (0.34% sulfuric acid soln). The decompn temps of these compns were detd as 240°, 205° and 150°F, respectively. Addn of 0.5% urea to each compn increased these temps to 400°, 250° and 250°F. In the expls patented by Kluensch et al (Refs 20 & 21) urea forms part of a eutectic mixt with other constituents which retains its liquidity to -30°. Typically, an expl mixt consisting of AN (52.5), Na nitrate (3.0), Al (22.0) and the gelatinizing eutectic (22.5%) contg methylamine perchlorate (16.0), methylamine nitrate (16.0), ethanolamine nitrate (45.0), urea (12.0), AN (11.0) and guar flour (2.5p) was fabricated which gave Trauzl test values of 500 to 550cc/10g and an impact sensy of 2.1kg-m. Clark (Ref 23) has made use of urea as a fuel in an expl paste compn which he claims can be prepd in the cold and detonated at low temps and high pressures. Thus, a slurry contg AN (46.2), Na nitrate (15.4), urea (15.4) and w (7.7p) was prepd, and its density adjusted by addn of glass microballoons. The inventor reports successful detonation at 21.1° and -1.1°. In another invention, that of Tezuka (Ref 24), urea is used as both a fuel and a gelatinizing agent. Thus, a slurry expl made from Na montmorillonite gel (w content 88%) (28), urea (3), AN (62) and powdered Al (7 wt p) was detonated and found to have a deton vel of 3900m/sec when freshly prepd. The same mixt after storage for 20 days at 20° had a deton vel of 3800m/sec. Sakai and Yamamoto (Ref 25) invented a slurry type expl using urea as a fuel which they claim has high storage stability, deton vel and detonator initiability. Thus, AN (73), urea (7), formaldehyde (9), w (10), guaiac gum (0.5) and Zn (0.5p), when mixed and heated at 50° for 10 minutes are reported to have produced a slurry expl having a sp grav of 0.92 and a deton vel of 4000m/sec. The inventors state that the expl could be detonated using a detonator having a 50g Dynamite primer. In the same vein, the team of Sakai, Takeuchi and Hanake (Ref 25a) claim in their invention a stable slurry incorporating urea with a deton vel range of from 2570 to 4160m/sec when initiated by 50g of Dynamite. Thus, AN

(68.7), urea (4.0), S (3.0), coal (0.9), ethylene glycol (1.4), guar gum (1.0), w (20.0) and Na dodecylidiphenyl ether disulfonate (1 wt %) are mixed to obtain the expl

Barnett (Ref 27) claims in his patent that the addn of urea retards the dissociation of hydroxyl-alkyl nitrate sensitizer expls by continuously buffering the pH above 4. Ethylene oxide vapor is treated with excess aq nitric acid and neutralized to pH 7 with ammonia to form the basic expl slurry contg w (175), ethylene glycolmononitrate (496), ethylene glycol (48) and AN (253p). The inventor states that addn of urea (5p) retards the time for the pH to drop to 4 at 70° from 1 day to 36 days. In McCallum's invention (Ref 29), urea is used to bind >75% of the available oxygen and decrease the generation of hydrochloric acid in a mine safety expl. Such a compn is reported as contg NG (5-20), AN (20-55), Na chloride (0-60), amm chloride (5-40), urea (2-10) and fillers (0-10%). Tezuka (Ref 31) uses urea as a fuel-gellation agent along with Na Montmorillonite to increase w content and maintain a high deton vel in his patented (unspecified) slurry expl. Thus, 28p Na montmorillonite-w gel (montmorellonite-w ratio 12/88) is stirred with urea (3) and the resulting mixt incorporated with AN (62), Al powder (5) and urea (2p) to produce a slurry expl with the claimed deton vel. In the same vein, Barnett (Ref 32) claims an expl, liq at -10° to 90°, using urea as a gellation-fuel constituent. Thus, urea (1750), AN (8180), a comml thickening agent (25), Na nitrate (5), diesel oil (70), and Zn hydroxychromate (10p) are stirred together at 50° to 60° to yield a fluid compn which when cooled to a solid has a d of 1.25g/cc and a deton vel of 4800m/sec. Lownds and Healy (Ref 34) claim a cap sensitive expl contg urea. A mixt of urea (4.5), AN (40.0), Na nitrate (26.20), atomized Al (4.0), tapioca flour (2.0), thiourea (0.1), w (14.0), guar gum (0.6), glycol (1.3), K antimoniate (0.165), paint-fine Al (1.5) and polyvinylchloride (5.5 unidentified units) forms a compn which can be initiated with a cap contg 45mg of PETN. Keith and Murray's patent (Ref 35) suggests an expl suspension using urea as the fuel, AN (60-85 wt %) as the expl in a w (3-25p) soln, guar and acacia gums as thickening agents, with animal or vegetable fibers (\geq 3%) acting as a suspension aid

Propellants. Satriana and Bracuti (Ref 30) claim the use of pyrolyzed urea as a ballistic modifier which when incorporated in a double-base plastisol proplnt produces a burning rate plateau. Thus, PbSnO_3 (90) and urea, acet and w (10g) are sintered for one hr at $500\text{--}50^\circ$, cooled, screened, molded and cured for use in a plastisol proplnt contg 30% HMX. Leach (Ref 37) reports that ballistic and other test results indicate that there is no significant difference between M30 proplnt contg Nitroguanidine prep'd by the urea/AN process and that prep'd by the standard British fusion process.

Specification. The requirements of the US Armed Forces are described in Military Specification **DOD-U-10866D** (17 April 1979) entitled "Urea, Technical (Metric)" (Ref 36) and are shown for Class 1 urea (a white crystn material free from visible impurities and foreign matter; suitable for manufacturing) in Table 2:

Table 2
Chemical and Physical Specification Requirements for Urea

Characteristic	Value	
	Min	Max
Nitrogen, % by wt ^a	46.0	46.7
Ash, % by wt ^b	—	0.003
Initial MP, °C ^c	132.0	133.0

Footnotes to Table 2:

a-In accordance with ASTM E258 using 0.5N acid procedure and a specimen wt of 0.50 to 0.60g

b-Gravimetrically by difference in wt after ign at 800° of a 50g sample

c-In accordance with ASTM E324

Refs: 1) Beil 3, 42–52, (19–24) & [35–43]
2) F. Wohler, PoggAnn 12, 253 (1828)
3) A. Basaroff, JPraktCh 7 (2), 283 (1870)
4) E. Schmidt, Ber 10, 191–93 (1877)
4a) R.L. Datta & J.K. Choudhury, JACS 38, 2737 (1916) 4b) J.E. Bucher, IEC 9, 250 (1917) 4c) N.W. Kruse & W.L. Grady, IEC 14, 611 (1922) 4d) R.S. McBride, ChemMet-Engrg 32, 791 (1925) 4e) Ullman, Vol 6 (1930), 104 5) H.M. Huffman, "... The Heats of Combustion of Urea ... and ... Standard Free Energies of Formation", JACS 62, 1009–11 (1940) & CA 34, 4332 (1940)

6) A.J. Phillips, "Develop Low-Melting Ammonium Nitrate Explosive", PATR 1106 (1941)
6a) E.F. Degering, "An Outline of Organic Nitrogen Compounds", Univ Lithoprinters, Yipsilanti (1945), 413–37 7) L.F. Fieser & M. Fieser, "Reagents for Organic Synthesis", J. Wiley & Sons, NY (1967), 1262–70 8) J.A. Arbie, "Explosive Gel Compositions", USP 3321344 (1967) & CA 67, 66206 (1967)
9) J.F. Anderson, "Explosions and Safety Problems in Handling Urea-Ammonium Nitrate Solutions", SafyAirAmmoniaPlants 9, 70–72 (1967) & CA 68, 41755 (1968) 10) R.J.E. Williams, "Investigations of Crystal Modification of Urea", ERDE-TR-13/M/67 (1968) (AD 670421) 11) W.E. Gordon, "Ammonium Nitrate Blasting Compositions", USP 3347722 (1967) & CA 68, 4593 (1968) 13) Anon, "Urea and Urea Derivatives", Kirk & Othmer, Vol 21, 37–56 (1970) 14) N.M. Jardine & R. Travers, "Ammonium Nitrate Explosive Compositions", SAfricanP 6807253 (1970) & CA 74, 143987 (1971) 15) J.W. Francis, "Ammonium Nitrate-Nitromethane Blasting Agents Containing Urea as a Crystallization Inhibitor", USP 3546034 (1970) & CA 74, 128370 (1971) 16) Ibid, USP 3546035 & CA 74, 128371 (1971)
17) not used 18) D.R. Forshey & E.C. Lisotto, "Urea-Stabilized Gelled Slurry Explosives", USP 3713918 (1973) & CA 78, 126469 (1973)
19) C.M. Mason & D.R. Forshey, "Urea-Modified Ammonium Nitrate-Fuel Oil Explosives", USP 3708356 (1973) & CA 78, 9993 (1973)
20) M. Kluensch et al, "Ammonium Nitrate Safety Explosives", GerP 2126922 (1972) & CA 78, 45855 (1973) 21) Ibid, "Energy-Delivering Eutectic Mixture for Explosives", GerP 2126921 (1972) & CA 78, 45856 (1973)
22) R.W. James, "Propellants and Explosives", Noyes Data Corp, Park Ridge (1974), 279–80 & 317–18 23) W.F. Clark, "Explosive Composition", FrP 2201269 (1974) & CA 82, 75175 (1975) 24) H. Tezuka, "Slurry Explosive", JapP 7531013 (1975) & CA 83, 100325 (1975)
25) H. Sakai & Y. Yamamoto, "Slurry Explosive with Improved Storage Stability", JapP 7601613 (1976) & CA 84, 166918 (1976) 25a) H. Sakai et al, "Stable Slurry Explosives", JapP 7588205 (1975) & CA 84, 166913 (1976)
26) K. Shiino et al, "Stable and Soluble Oxidizing Agents for Liquid Explosives", JapP

7571809 (1975) & CA 84, 108022 (1976)
 27) G.H. Barnett, "Nitratealkanol-Containing Compositions for Stabilizing Explosives", GerP 2555335 (1976) & CA 85, 145418 (1976)
 28) S.M. Song, "Improvement of the Process for Urea Manufacture", HwahakKonghak 14 (4), 215-21 (1976) & CA 86, 16275 (1977)
 29) G.H. McCallum, "Safety Explosive Compositions", GerP 2553055 (1976) & CA 86, 57653 (1977) 29a) CondChemDict (1977), 905
 30) D.R. Satriana & A.J. Bracuti, "Ballistic Modifier", USP 4082584 (1978) & CA 89, 45946 (1978) 30a) ChemRubrHdbk (1978), C-536 31) H. Tezuka, "Slurry Explosives. . .", JapP 7859014 (1978) & CA 90, 57495 (1979)
 32) G.H. Barnett, "Explosive Composition", BrazilianP 7707703 (1978) & CA 90, 57497 (1979) 33) T.A. Ryzkova et al, "Results of Studies of Explosive Systems Based on Urea", VzryvnDelo (80-37), 14-21 (1978) (Russ) & CA 90, 40983 (1979) (no English translation available - not used) 34) C.M. Lownds & N.A. Healy, "Explosive Blasting Compositions", SAfricanP 7706117 (1979) & CA 91, 177538 (1979) 35) D.G. Keith & R.S. Murray, "Explosive Composition in Suspension", BrazilianP 7804002 (1979) & CA 91, 159890 (1979)
 36) Anon, "Urea, Technical (Metric)", DOD-U-10866D (1979) 37) J.W. Leach, "Ballistic Evaluation of M30 Propellant Containing Nitroguanidine Derived from Urea/Ammonia Nitrate Process", ARLCD-TR-78063 (1978) (AD-E 400284) & CA 91, 195396 (1979) 38) J.W. Leach, "Detonation of Guanidine Nitrate and Nitroguanidine Manufactured Via U/AN and BAF Process", ARLCD-TR-78062 (1979) (AD-E 400346 & AD-A 075338) & CA 92, 200430 (1980) 39) not used 40) K. Konoki & M. Nobue, "Elimination of Explosiveness of Tail Gas in the Process of Urea Production", JapP 79151917 (1979) & CA 92, 163578 (1980)
 41) T. Jojima, "Urea Reactor Failure", AmmoniaPlantSafy 21, 111-18 (1979) & CA 92, 220190 (1980)

Urea Addition Compounds and Salts

Urea Calcium Nitrate. $6(\text{NH}_2)\text{C}:\text{O} + \text{Ca}(\text{NO}_3)_2$; mw 524.46; N 5.34%; OB to CO_2 -36.61%; cryst (from ethanol); mp, explds on rapid heating (Ref 1, p 56)

Urea Chromi-Hexaurea Chlorate.

$[\text{Cr}(\text{CNH}_2)_2\text{C}:\text{O}]_6(\text{ClO}_3)_3$; mw 662.72; N 25.39%; OB to CO_2 -21.75%; grn crystals; mp, expl mildly with evoln of flame when heated. Fairly sol in w, sl sol in ethanol; insol in benz, chl and eth. Prepn is by reacting a hot concd soln of chromihexaurea chloride with Na chlorate and then cooling the mixt rapidly in ice-w (Ref 1, p [46])

Urea Chromi-Hexaurea Sulfatochlorate.

$[\text{Cr}(\text{CNH}_2)_2\text{C}:\text{O}]_6(\text{SO}_4)(\text{ClO}_3) + \text{H}_2\text{O}$; mw 591.87; N 28.41%; OB to CO_2 -48.66%; grn ndles; mp, detonates mildly with flame on heating. Sl sol in w; not sol in org solvents (Ref 1, p [46])

Urea Hexakis Gallium (III) Triperchlorate.

$[\text{Ga}(\text{CNH}_2)_2\text{C}:\text{O}]_6^{++++} \cdot 3\text{ClO}_4^-$; $\text{C}_6\text{H}_{24}\text{Cl}_3\text{GaN}_{12}\text{O}_{18}$; mw 728.43; N 23.08%; OB to CO_2 -14.8%; small colorl ndles; mp 179°; bp, detonates mildly on strong heating. Decompd on contact with w. CA Registry No [31332-72-6]. Prepn is by mixing 1 mole of Ga triperchlorate with 6 moles of urea in ethanol, evapn of the soln until crystals are formed, and then recovery of the crystals from warm ethanol (Refs 1, p {107}, 10a and 17a)

Urea Nitrate (Acidogen nitrate).

$\text{O}=\text{C}\begin{array}{l} \text{NH}_2 \\ \text{NH}_2 \end{array} \cdot \text{HNO}_3$, $\text{CH}_5\text{N}_3\text{O}_4$; mw 123.06; N 34.14%; OB to CO_2 - 6.5%; colorl monocl lfts; mp 140°, 152°, 157°, 160-62° (separate values); d 1.59g/cc. V sol in hot w; sol in ethanol; sl sol in w; insol in benz, chl, and eth. CA Registry No [124-47-0]. Prepn is by adding an excess of nitric acid to a concd aq soln of urea and then chilling the mixt. The quantity of product is increased by allowing subsequent crystn to occur in the reacted soln for several hrs. Markalous et al (Ref 21) suggest that by treating urea with

65% nitric acid in the presence of phosphoric acid, a product is obtd which they claim is expln safe in storage and transport even when absol dry

Urea nitrate has a deflagration pt of 186°; a deton rate of 3400m/sec (at d 0.85g/cc in a 30mm diam paper tube when driven by 1.5g of MF), and 4700m/sec (at d 1.20g/cc in a 30mm diam steel tube when driven by 1.5g of MF); friction sensy of up to 36kp pistol load with no reaction; gas evolution of 896l/kg on deton; heat of combstn at constant vol of 1071.7cal/g; heat of expln of 639kcal/kg, ΔH_f of 1090 kcal/kg; hygry at 25° of +0.76% at 90% RH and +23.2% at 100% RH; 100° heat test of not acid and no expln in 300 minutes; 135° heat test of acid in 30 minutes but no expln in 300 minutes; an impact sensy of up to 5kpm = 49Nm with no reaction; power by BalMort of 92% TNT and by Trauzl test of 270cc/10g, a sensy comparable with TNT; and satisfactory storage stability when dry (Refs 1 thru 12, 14 thru 17 & 17b)

The compd, according to Perez-Ara (Ref 13), has been used in some expl mixts for the purpose of lowering the expln temp. It was also incorporated in some smokeless powders to serve as a stabilizer. Also, the expls patented by Cook & Ursenbach (Ref 18) are of interest. They claim an expl slurry in which urea nitrate is formed on mixt of the slurry's ingredients. The nitration effect of the nitric acid constituent is restricted to that of adduct formation by the use of refrigeration and the addn of endothermic salts such as AN to the mixt. Typically, a blasting compn prepd from concd nitric acid (39), AN (26), urea (13), ground gilsonite (6.5), w (15.5) and guar gum (0.05p by wt), although strongly acid, is reported to be of acceptable viscosity and to have detonated with "good" blasting power. In their invention, Lazarov et al (Ref 19) claim a new safety expl with good w-resistance based on urea nitrate. Urea nitrate (73), K nitrate (22) and TNT (5%) are mixed together to form the patented compn). In Ref 20, Lazarov et al discuss the manuf of urea nitrate, its use in expl compns, and the expl properties of urea nitrate compns with AN, Na nitrate, K nitrate and TNT, incorporated either individually or in concert. In summing up their work they report that the best mining expls are comprised of mixts of urea nitrate and K nitrate. Bakharevich & Kukib

(Ref 22) report that their work in an exptl mine with various combinations of urea nitrate, K chloride, various nitrate esters and AN did not produce the desired combination of detonation ease and high vel safety and workability expected of mine expls. Kai et al (Ref 27) suggest the use of urea nitrate as a sensitizing agent in their patented expl slurry. Additionally, they claim improvement in fluidity, ign sensy and deton vel over other compns. Thus, powdery urea nitrate (28), w (18), Na laurylsulfate (0.3), AN (51.8), guar gum (0.4) and perlite (1.5p) are mixed at 85° to obtain an expl slurry with a sp grav of 1.09, deton vel of 3600m/sec, and good fluidity

Sax (Ref 16a) considers the nitrate to be a slight local irritant. However, no information is available on acute or chronic system effects

Urea Perchlorate.

$$\text{O}=\text{C}\begin{array}{l} \nearrow \text{NH}_2 \\ \searrow \text{NH}_2 \end{array} \cdot \text{HClO}_4, \text{CH}_5\text{ClN}_2\text{O}_5; \text{mw } 160.52; \text{N } 17.46\%; \text{OB to CO}_2 \text{ +4.98\%; v hygroscopic and unstable white crystals; mp, expls on heating without burning. V sol in w. CA Registry No [1872-07-6]. Prepn is by the interaction of equimolar amounts of urea and perchloric acid in acetic acid followed by solvent evapn. Its impact sensy is comparable to that of TNT (Refs 1 and 17a)$$

The perchlorate has been incorporated into more than several expl compns. Shiino et al claim in their patent (Ref 23) that a liq expl of high deton vel can be made by dissolving solid aromatic nitro compds into aq urea perchlorate. Thus, PA (5) is dissolved in 85% aq urea perchlorate (95 wt p) to obtain a liq expl having a d of 1.6g/cc and a deton vel of 6520m/sec. In the invention of Fujiwara et al (Ref 24) an expl slurry of improved stability is claimed consisting of a mixt of combustible solids in aq urea perchlorate soln. Typically, powdered K perchlorate (30) and powdered ferrosilicon (30) are added to 85% aq urea perchlorate (50 wt p) to form a slurry-like expl having a d of 1.71g/cc and a deton vel of 3700m/sec, as well as high stability. In another patent, Shiino et al (Ref 25) claim a process for the prepn of the expl perchlorate, per se. Thus, 430g of urea are added slowly to 1000g of 71% aq perchloric acid at <20° to give the 1:1 urea perchlorate salt

crysts. The patent shown in Ref 26 suggests the use of the perchlorate in an underwater blasting slurry when incorporated with materials such as PA. The claimed impact sensy is >60cm (5-kg wt from 60cm resulting in 0/6 trials). Fujiwara et al, as a result of their work (Refs 29 & 30) with aq urea perchlorate solns mixed with various organic substances, report that with detonatable materials such as PA, the solns formed are impact insensitive but powerful expls exhibiting two distinct deton modes: low vel deton (LVD) (~1900m/sec) and high vel deton (>6000m/sec). Mixts with nondetonatable substances as nitrobenzene or dimethylformamide show only LVD, requiring an extremely high critical initiation pressure of approx 40kbar

Urea Picrate (or Urea + 2,4,6-Trinitrophenol).

$$\text{O}=\text{C}\begin{array}{l} \text{NH}_2 \\ \text{NH}_2 \cdot \text{HO} \cdot \text{C}_6\text{H}_2(\text{NO}_2)_3, \text{C}_7\text{H}_7\text{N}_5\text{O}_8; \\ \text{mw } 289.19; \text{N } 24.22\%; \text{OB to CO}_2 \text{ } -52.56\%. \end{array}$$
 The compd has two isomers whose prepn and properties are shown in Table 3

Urea Sodium Nitrate

$$\text{O}=\text{C}\begin{array}{l} \text{NH}_2 \cdot \text{H}_2\text{O} \\ \text{NH}_2 \cdot \text{NaNO}_2, \text{CH}_6\text{NaN}_3\text{O}_4; \text{mw } 141.09; \\ \text{N } 29.79\%; \text{OB to CO}_2 \text{ } -11.34\%; \text{prisms; mp,} \\ \text{expls on heating. Sol in w (Ref 1, p 55)} \\ \text{Refs: 1) Beil } 3, 54-59, (25-27), [45-48] \& \\ \{107\} \quad 2) \text{ S.M. Tanatar, JRussPhysChemSoc} \\ 40, 378 (1908) \quad 3) \text{ Ibid, JCS } 94\text{I}, 399 (1908) \end{array}$$

4) G. Barbieri, AttiAL (5) 22, I, 867-70 (1913) & CA 7, 3937 (1913) 5) E. Werner, "The Chemistry of Urea", Longmans, London (1923)
 6) J.R. Booer, JSCI (Chem/Ind) 44, 1137 (1925)
 7) T.L. Davis et al, JACS 51, 1798 (1929)
 8) S. Micewicz, PrzemyslChem 10, 56-58 & 136-37 (1926) & CA 25, 3964 (1931) 9) E. Wilke-Dürfurt & K. Niederer, ZAnorgChem 184, 147-53 (1929) 10) A. Stettbacher 1, 298 (1933) 10a) D.J. Lloyd & W. Pugh, JCS, 77 (1943) 11) Davis (1943), 372 11a) Blatt, OSRD 2014 (1944) 12) V.M. Slater, Chem&Ind, 42-46 (1945) 13) A. Pérez-Ara (1945), 613-14 14) L.C. Smith & E.H. Eyster, OSRD 5746 (1945) 15) ADL II (1947), 259 15a) R.A. Ongley, "Isomeric Form of Urea Picrate", Nature 159, 812 (1947) & CA 41, 5771 (1947) 16) L. Médard & M. Thomas, "Calorimetric Measurements Concerning Eighteen Organic Nitrate Derivatives", MP 31, 173-96 (1949) & CA 46, 11684 (1952) 16a) Sax (1968), 1220 17) L. Médard, "Explosive Properties of Urea Nitrate . . .", MP 33, 113-23 (1951) & CA 47, 5683 (1953) 17a) O.W. Kolling, AnalChem 40, 956 (1968) 17b) Urbański 2 (1965) 469-70 18) M. Cook & W. Ursenbach, "Urea-Nitric Acid Addition Product Explosives", USP 3457127 (1969) & CA 71, 72519 (1969) 19) Sl. Lazarov et al, "Creation of New Explosives Based on Urea Nitrate", Vughlishta 26 (7), 12-16 (1971) & CA 74, 131265 (1971) 20) S. Lazarov et al, "Production of New Urea-Nitrate Explosives", TrMinniYaNauchnoizsledProektKonstrInst 11, 38-91 (1972) & CA 79, 94169 (1973)

Table 3
Preparation and Properties of the Isomeric Forms of Urea Picrate
(from Refs 11a & 15 a)

Forms and Crystalline Type	Preparation	Solubility	Melting Point, °C	Impact Sensitivity
A; monoclinic or triclinic (?)	Mixing solns of Picric Acid and Urea	Hot ethanol	142°; 144° (separate values) decompn at 270°	156cm (86% TNT)
B; orthorhombic	Recrystallization of form A from ethanol, or by chromatography of form A in ethanol	Hot ethanol	275°	323cm

21) F. Markalous et al, "Phlegmatous Urea Nitrate", CzechP 152080 (1974) & CA 81, 48861 (1974) 22) N.S. Bakharevich & B.N. Kukib, "Use of Urea Nitrate in Permissible Explosives", Vzryvnoe Delo 72, 20-24 (1973) (Russ) & CA 82, 75122 (1975) 23) K. Shiino et al, "Liquid Explosives", JapP 7525720 (1975) & CA 83, 134504 (1975) 24) S. Fujiwara et al, "Explosive", JapP 74134813 (1974) & CA 83, 100319 (1975) 25) K. Shiino et al, "Stable and Soluble Oxidizing Agents for Liquid Explosives", JapP 7571809 (1975) & CA 84, 108022 (1976) 26) Anon, "Explosive Compositions", BritP 1429282 (1976) & CA 86, 45350 (1977) 27) H. Kai et al, "Slurry Explosive with Improved Fluidity and Explosion Velocity", JapP 7542016 (1975) & CA 84, 152902 (1976) 28) Meyer (1977), 312-13 29) S. Fujiwara et al, "Homogeneous Liquid Explosives Containing Urea Perchlorate", ACR-221, Proc 6th Symp (Int) Deton, 450-54 (1976) & CA 91, 159856 (1979) 30) Ibid, "Studies on the Detonation . . . Liquid Explosives Containing Urea Perchlorate", KogyoKayaku 40 (2), 117-21 (1979) & CA 92, 79028 (1980)

Urea Condensation and Polycondensation Products (Resins)

Of initial interest here are the *Urea-Formaldehyde Resins*. These are products of a condensation type reaction primarily between urea and formaldehyde. Prepn of the resins requires a two-stage process conducted in the presence of pyridine, ammonia or various alcohols, employing heat and controlled pH to form intermediates such as methylolurea or dimethylolurea which are then mixed with fibers to produce molding powders. These are converted to thermosetting resins by further controlled heating in the presence of catalysts. These resins are among the most widely used in plastics and have found application in the field of energetic materials; viz, in *expls* as a desensitizing medium for NG (Refs 3 & 4), and as an *expl* fuel and w-resistant binder (Refs 5, 11 & 12); in *proplnts* as a means of adjusting compn density and burning rate (Refs 6 & 7); in *pyrots* as a fire-starting compn's fuel-binder system (Refs 8, 9 & 10). Also, see

in Vol 6, F164-L to F165-L under "Formaldehyde Polymers"

An example of an *expl* resin formed from urea and formaldehyde is entered in Vol 5, D1337-R under "Dimethylene Peroxide Carbamide". In Vol 6, F165-R it is mentioned under "Formaldehyde and Derivatives". The information on this *expl* is updated in Vol 9 under "Tetramethylene-Diperoxide Dicarbamide"

Other urea resins of interest are "The Polyurea Polymer of 3,3-Dinitro-1,5-Pentane Diisocyanate and 3,3-Dinitro-1,5-Pentanediamine" entered in Vol 8, N144-R to N145-L and "The Post Nitrated Polyurea Polymer of 3-Nitro-3-Aza-1,5-Pentane Diisocyanate and Water", also to be found in Vol 8, N145-L

Refs: 1) Beil 3, 27, [48] & {112} 2) C.E. Schildknecht, "Polymer Processes . . .", Interscience, NY (1956), 296 ff 3) K.E. Ripper, "Explosives", USP 2334149 (1944) & CA 38, 2824 (1944) 4) L. Maljucskova et al, "Granulated Ammonium Nitrate Explosive", HungP 1121 (1970) & CA 74, 128373 (1971) 5) Y. Wakazono & Y. Ohtsuka, "Slurry Explosive Compositions", JapP 7034958 (1970) & CA 75, 8105 (1971) 6) C. McCulloch et al, "Propellant and Consumable Cartridge", USP Appl 473456 (1974) & CA 85, 179850 (1976) 7) K. Kishore, "Combustion Behavior of Some Cross-Linked Synthetic Resins", ColloidPolym-Sci 255 (2), 180-81 (1977) & CA 86, 107303 (1977) 8) K. Bitter, "Igniters for Coal", EGerP 122688 (1976) & CA 87, 104313 (1977) 9) D. Neil & D.M. Seager, "Fire Igniter Composition", GerP 2645872 (1977) & CA 87, 87728 (1977) 10) T.F. Smith & A. Timmons, "Fuel Composition", GerP 2631038 (1977) & CA 87, 70821 (1977) 11) P.F. Donachue & K.A.W. Mitchell, "Explosive Composition", BrazP 7707795 (1978) & CA 90, 89641 (1978) 12) Ibid, "Immobilized Explosive Component in Foamed Matrix", USP 4151022 (1979) & CA 91, 59637 (1979) 13) CondChemDict (1977), 905 14) Kirk & Othmer 2 (1978), 440-69 [I.H. Updegroff et al, "Amino Resins and Plastics"]

Urea Derivatives Formed by Partial Substitution

There are a great many in vivo as well as synthetic derivatives of urea. Presented next are urea derivatives which are of use in the area of energetic materials:

N-Alkyl-N'-(5-Tetrazolyl)-Ureas and N,N-Dialkyl-N'-(5-Tetrazolyl)-Ureas. See in Vol 1, A132-R to A133-L

N-Allyl-N',N'-Diphenylurea. See in Vol 1, A137-R

Aminoethylureas and Derivatives. See in Vol 1, A209-L & R

Aminoethylpropylureas and Derivatives. See in Vol 1, A206-L

Bis Diphenylurea. See in Vol 2, B142-L

Bis (Phenyl)-Urea and Derivatives. See in Vol 2, B155-R to B156-L

Bis (2,2,2-Trinitroethyl)-Urea (BTNEU). See in Vol 5, D1254-R to D1255-R under "Diethylurea and Derivatives"

Bis (1,1,1-Trinitro-Isobutyl)-Urea. See in Vol 2, B160-R

Biurea. See in Vol 2, B164-L

Carbamylurea and Derivatives. See in Vol 2, B164-L & R under "Biuret and Derivatives"

Centralites. See in Vol 2, C126-R to C140-R and the following *Addnl Ref*: Anon, "Nitrocellulose Propellant", BritP 1190317 (1971) & CA 75, 142432 (1971) [The patent claims that by applying dibutylphthalate and various Centralites to the surface of tubular NC proplnt grains the combstn rate of the proplnt is increased, therefore increasing the ballistic efficiency. Several stages of treatment are required using dibutylphthalate in ethanol as the first stage, followed by the second stage which requires that either Centralite-1, -2, or -3 be dissolved in ethanol and applied to the proplnt's surface. Thus, di-

butylphthalate (30-40 wt %) in ethanol is sprayed onto the surface of the tubular NC proplnt grains and air-dried for 10 hrs at 42-45°. The second surface treatment involves an ethanolic soln of one of the Centralites (20-30 wt %) which is heated to approx 40° and applied in two equal steps at one hr intervals. The treated proplnt is then allowed to air dry at RT for 3 hrs]

Dibutylurea and Derivatives. See in Vol 5, D1200-L & R

N,N'-Dibutyl-N,N'-Diphenylurea. See in Vol 2, C140-L & R under "Centralite, Butyl"

N,N'-Diethyl-N,N'-Diphenylurea. See in Vol 2, C127-L to C137-L under "Centralites"

Diethylurea and Derivatives. See in Vol 5, D1254-R to D1255-R

Dihydrodiacetoneurea. See in Vol 1, A403-R to A404-L

N,N'-Dimethyl-N,N'-Diphenylurea. See in Vol 2, C137-L to C139-L under "Centralite 2"

Dimethylphenylurea and Derivatives. See in Vol 5, D1366-R to D1367-L

Dimethylurea and Derivatives. See in Vol 5, D1378-R and the following *Addnl Ref*: B.D. Allan, "Gelled Monomethylhydrazine Thixotropic Fuel", USP 4039360 (1977) & CA 88, 63822 (1978) [The inventor suggests the use of dimethylurea as a constituent of the gellant used in his thixotropic rocket proplnt. He claims that a low quantity gellant is required because the compds used, a hydroxypropyl cellulose called "Klucel" plus the dimethylurea, suspend the metal fuel particles in such a manner that they will not separate or settle out of the fuel mixt even when the proplnt is subjected to 500g's of force. He further claims that the patented fuel has both a high density and a high specific impulse. Typically, "Klucel" (1.4), dimethylurea (0.1), 6 to 10 micron Al (60.00), and Monomethylhydrazine (38.5 wt %) are mixed to form the patented proplnt]

1,5-Dinitrobiuret, Salts. See in Vol 5, D1385-R.
Note: This compd by a stretch of nomenclature could be called 1,5-Dinitrocarbamyurea

N,N'-Dinitro-N,N'-Trimethyleneurea. See in Vol 7, H76-R

Diphenylacetyleneurea and Derivatives. See in Vol 5, D1461-R to D1462-L under "Diphenylglycoluril and Derivatives"

N,N'-Diphenyl-Iminourea; See in Vol 5, D1462-L

N,N'-Di (2-Phenyl-5-Tetrazolyl)-urea. See in Vol 4, D1482-R

asym-Diphenylurea. See in Vol 1, A7-R to A8-L under "Acardite . . ."

sym-Diphenylurea and Derivatives. See in Vol 2, B155-R to B156-L and in Vol 5, D1487-L

Dipropylurea and Derivatives. See in Vol 5, D1501-L & R

N,N'-Di (Tolyl)-Ureas and Derivatives. See in Vol 5, D1520-L and R

Diurea. See in Vol 1, A472-L under "4-Amino-Urazole" and in Vol 5, D1523-L

Ethanol Diphenylurea. See in Vol 6, E182-R

Ethylenebisurea and Derivatives. See in Vol 6, E233-L & R

Ethyleneurea and Derivatives. See in Vol 6, E291-R to E292-R

N-Ethyl-N'-Methyl-N,N'-Diphenylurea. See in Vol 2, C139-R under "Centralite 3"

Ethylphenylureas and Derivatives. See in Vol 6, E322-R to E323R

N-Ethyl-N'-Tolyl-N,N'-Diphenylurea. See in Vol 2, C140L under "Centralite 4"

Ethylurea and Derivatives. See in Vol 6, E337-L & R

Guanylurea and Derivative. See in Vol 5, D1217-R to D1218-L under "Dicyandiamidine and Derivatives", and the following *Addnl Ref:* on **GuanylNitrourea:** S. Helf, "Long Range Research Leading to the Development of Ideal Propellants . . .", PATR 1752 (1949) [The author reports that the compd was found to be unstable at both 100 and 120°; comparatively stable at below 100° and compatible with NC. The following properties are also reported; N 47.7%; OB to CO and H₂O -27%; mp >250°; d 1.93 g/cc; impact sensy 40+" (2-kg wt); expln temp 185°; 12.1g sand crushed using 0.2g Tetryl plus 0.2g LA as initiator; heat of combstn -298 kcal/mole; heat of expln 422cal/g; relative energy -312cal/g; and mean heat capacity 0.354cal/°C]

Guanylurea Nitrate.

$$\text{O}=\text{C} \begin{array}{l} \text{NH}_2 \cdot \text{HNO}_3 \\ \text{NH} \\ \text{HN}-\text{C}-\text{NH}_2 \end{array}$$
 $\text{C}_2\text{H}_7\text{N}_5\text{O}_4$; mw 165.14, N 42.4%; OB to CO₂ -33.91%; crysts; mp 216° (decompn); d 1.54g/cc. Sol in w. Prepn is by the quant reaction of guanidine with nitric acid at 90-100°

The salt is compatible with NC; has an expln temp of 320°; a hygry at 30° and 90% RH of 0.1%; an impact sensy of 58" (2-kg wt); a 100° heat test of 0.17% wt loss in 48 hrs; a 120° vac stab test result of 1.54ml of gas/5g in 40 hrs; a heat of combstn of 296kcal/mole; a heat of expln of 364cal/g; and a relative energy of 460cal/g

Helf (Ref 2) considers the compd a suitable substitute for Nitroguanidine in proplnts as a flash and smoke suppressant

Refs: 1) Beil, not found 2) S. Helf, "Long Range Research Leading to the Development of Ideal Propellants . . .", PATR 1752 (1949)

Glycolurea and Derivatives. See in Vol 7, H188-L & R under "Hydantoin and Derivatives"

N,N-Mesoxalyl Urea. See in Vol 1, A134-R

N'-Methyl-N-N-Diphenylurea. See in Vol 1, A8-L ro A11-L under "Acardite II . . ."

Nitrourea (NUR or N-Nitrocarbamide).

$$\text{O} = \text{C} \begin{array}{l} \text{NH.NO}_2 \\ \text{NH}_2, \text{CH}_3\text{N}_3\text{O}_3; \text{mw } 105.06; \text{N } 39.98\%; \\ \text{OB to CO}_2 \text{ } -7.61\%; \text{colorl platelets (from} \\ \text{ethanol plus eth); mp } 158.4\text{--}8^\circ \text{ (decompn).} \\ \text{Freely sol in acet, acetic acid and ethanol; sol} \\ \text{in hot w (forms cyanic acid and nitroamide); sl} \\ \text{sol in benz, chl f and petr eth. CA Registry No} \\ \text{[556-89-8]. Prepn is by dehydration of Urea Ni-} \\ \text{trate with concd sulfuric acid. The compd can be} \\ \text{detonated but is not sensitive to percussion or} \\ \text{heating (Ref 7)} \end{array}$$

NUR has an energy of formation of -614.3 kcal/kg; an enthalpy of formation of -639.7 kcal/kg; a heat of combstn of 133.56 kcal/mole at const vol; a heat of expln of 789 kcal/kg; an impact sensy of incomplete expln at $18''$ (using a 2-kg wt in a PA app where $\text{TNT}=14''$, giving NUR a FI of 99% PA); power and brisance by Pb block expansion of 310cc (or 94% PA); a sand test value of 0.4g of NUR crushing $28\text{--}30\text{g}$ of sand; a specific energy of 93.0mt/kg ; and a vol of deton gases of 853l/kg

According to the patent listed as Ref 2, NUR alone or in a compn can be detond by a No 8 (strong) MF cap with great brisance. Typically, a compn consisting of NUR (83) and K nitrate (17%) is suggested which is claimed to be insensitive to ordinary percussion or heat. Davis (Ref 3) reports that NUR is a cool expl which he considers quite suitable for use in an expl or proplnt compn if it were not for the fact that it tends to decomp sponty in the presence of moisture. According to Urbanski (Ref 6) the Ag and Hg (ic) salts of NUR are more sensitive to impact than Nitrourea itself, however, they have no initiating properties

According to Sax (Ref 6a) NUR presents a severe expln hazard when shocked or exposed to heat, and a disaster hazard since it emits highly toxic fumes of nitrogen oxides when heated to decompn. Also, NUR can react vigorously with oxidizing materials

Refs: 1) Beil 3, 125, (59) & [99] 2) Anon, "Explosive", BritP 142303 (1919) & CA 14, 2713 (1920) 3) Davis (1943), 373-74 4) Blatt, OSRD 2014 (1944) 5) ADL, Part 1 (1947), 111 6) Urbanski 3 (1967), 33-34 6a) Sax (1968), 976 7) Merck (1976), 863 (No 6471) 8) Meyer (1977), 200

Phenylurea and Derivatives**Phenylurea (or Phenylcarbamide).**

$$\text{O} = \text{C} \begin{array}{l} \text{NH.C}_6\text{H}_5 \\ \text{NH}_2, \text{C}_7\text{H}_8\text{N}_2\text{O}; \text{mw } 136.17; \text{N } 20.58\%; \\ \text{monoclinic cryst from w; mp } 147^\circ \text{ (decompn at} \\ \text{160}^\circ\text{); bp } 238^\circ\text{; d } 1.302\text{g/cc. Sol in hot ethanol,} \\ \text{hot eth and hot w; sl sol in eth. CA Registry No} \\ \text{[64-10-8]. It yields more or less expl compds} \\ \text{on nitration as shown below. The compd also} \\ \text{forms salts such as the Nitrate, } \text{C}_7\text{H}_8\text{N}_2\text{O.HNO}_3\text{;} \\ \text{cryst; decomp at } 131\text{--}35^\circ \\ \text{Refs: 1) Beil 12, 346, (230) \& [204] 2) A.H.} \\ \text{Blatt \& H. Gilman, Eds, "Organic Synthesis",} \\ \text{Coll Vol 1, John Wiley, NY (1944), 453 (T.L.} \\ \text{Davis \& K.C. Blanchard) 3) Merck (1976),} \\ \text{952 (No 7126) 4) ChemRubHndbk (1978),} \\ \text{C-539} \end{array}$$

Mononitrocompounds of Phenylurea.

$\text{O}_2\text{N.C}_6\text{H}_4.\text{NH.CO.NH}_2, \text{C}_7\text{H}_7\text{N}_3\text{O}_3; \text{mw}$
 $181.44; \text{N } 26.46\%; \text{OB to CO}_2 \text{ } -127.89\%.$ CA Registry No [1932-32-7]

2-Nitrophenylurea. Yel cryst from w; mp $181\text{--}84^\circ$ (Refs 1, p (343) and 2, p 46)

4-Nitrophenylurea. Yel cryst; mp $232\text{--}38^\circ$ (decompn). CA Registry No [556-10-5] (Refs 1, p 723, (353) & [392], and 2, p 46)

2,4-Dinitrophenylurea.

$(\text{O}_2\text{N})_2\text{C}_6\text{H}_3.\text{NH.CO.NH}_2, \text{C}_7\text{H}_6\text{N}_4\text{O}_5; \text{mw}$
 $226.8; \text{N } 24.71\%; \text{OB to CO}_2 \text{ } -84.66\%; \text{yel}$
 $\text{ndles from ethanol; mp, starts to melt at about}$
 $176^\circ \text{ and decomps at } 194\text{--}200^\circ \text{ (Refs 1, p (363)}$
 $\& [410], \text{ and 2, p 42)}$

N'-Nitro-N-2,4-Dinitrophenylurea [called 2,4-Dinitrophenylnitroharnstoff (Ger) by Giua].

$(\text{O}_2\text{N})_2\text{C}_6\text{H}_3.\text{NH.CO.NH.NO}_2, \text{C}_7\text{H}_5\text{N}_5\text{O}_7; \text{mw}$
 $271.62; \text{N } 25.96\%; \text{OB to CO}_2 \text{ } -55.96\%; \text{orange-}$
 $\text{red lefts from ethanol; mp, violent decompn at}$
 $142\text{--}57^\circ.$ Prepn is either by nitrating phenylurea (Ref 2) or by treating dinitrophenylcyanamide with fuming nitric acid (Ref 2). Easily sol in acet; sl sol in eth; insol in petr eth or benz. Termed by Ref 4 as an expl of rather low power as compared to PA, but with a sl

greater sensy to friction and impact than PA
Refs: 1) Beil **12**, 694, 706 & 723; (343, 348,
 353 & 363); [380, 392 & 410] 2) J.F.L.
 Reudler, *Rec* **33**, 35–49 (1914) & *CA* **8**, 2373–
 75 (1914) 3) M. Giua & R. Petronio, *JPrakt-*
Chem **110** [2], 300 (1925) 4) J.L. McVeigh
 & J.D. Rose, "N-Nitro-N'-2,4-Dinitrophenylurea
 . . .", *JCS*, 621–22 (1945) & *CA* **40**, 320 (1946)

2,4,6-Trinitrophenylurea (or *Picrylurea*). See in
 Vol **8**, P299-L & R under "Picrylurea"

N-Trinitroethyl-N-(3,4-Dinitrophenyl)-Nitrourea.
 $(\text{O}_2\text{N})_2\text{C}_6\text{H}_3.\text{N}(\text{NO}_2).\text{C}:\text{O}.\text{NH}.\text{CH}_2.\text{C}(\text{NO}_2)_3$;
 $\text{C}_9\text{H}_6\text{N}_8\text{O}_{13}$; mw 434.23; N 25.81%; OB to CO_2
 –29.48%; d 1.78g/cc. Prepn is by nitration with
 mixed acid of N-Trinitroethyl-N'-phenylurea.

The compd has a 50% pt impact sensy of 45cm
 (BuMines machine, 2-kg wt). The authors note
 in the ref that at NOL the compd failed to de-
 tonate at a drop height of 320cm

Ref: W.F. Sager & D.V. Sickman, "Second
 Report on . . . New Chemical High Explosives",
NAVORD 483 (1952), 19

Urethanes and Derivatives. See in Vol **2**, C40-R
 to C42-L under "Carbamic Acid Ethyl Esters or
 Urethanes", and C43-R under ". . . Picrylure-
 thane"; in Vol **5**, D1487-R to D1488-L under
 "Diphenylurethane and Derivatives"; in Vol **6**,
 E337-R to E338-L under "Ethylurethane and
 Derivatives", and G116-R to G117-L under
 "Glycolurethanes and Derivatives"; and in Vol **8**,
 P410-L to P411 (Table 8) under "Propellants,
 Solid"; and the following *Addnl Refs:* 1) A.P.
 Glazkova & P.P. Popova, "Possibility of Prepar-
 ing Safety Explosives with Decreased Combustion
 Tendency", *VzryvnoeDelo* **68/25**, 265–71
 (1970) & *CA* **73**, 79063 (1970) [The authors
 studied the effectiveness of ammonia salts
 (oxalate, citrate, tartrate, carbonate, and fluoride)
 and urethane as combustion inhibitors for AN
 safety expls by measuring the combstn rates of
 various ammonite-type expls with and without
 the additives as a function of pressure (up to
 1000kg/cm²). They found that the addn of
 from 5 to 10% of either NaF or urethane to be
 the most effective of the combstn inhibitors] 2)
 A.P. Glazkova & O.K. Andreev, "Decreasing
 the Combustibility of Ion-Exchange Explosives",

VzryvnoeDelo **75**, 204–09 (1975) & *CA* **84**,
 76529 (1976) [The authors report on their
 work to reduce the combustibility of ion-
 exchange expls by addn of either amm oxalate
 or 10% urethane and measuring the burning rate
 as a function of pressure. The study used an expl
 compn contg NG (9.5), K nitrate (47.5) amm
 chloride (30.75), urethane (10), Si dioxide
 (0.65) and NC (1.6%). This mixt without
 additives burned at low pressure with combstn
 starting at 100kg/cm². At $\leq 700\text{kg/cm}^2$, the
 expl burned more rapidly than Ammonite 80-20.
 Addn of urethane caused an increase of the
 inhibition coeff to ≤ 1.83 at 200kg/cm² and
 1.7 in the 800–1000kg/cm² pressure range]

–**Uril, Glycol and Derivatives.** See in Vol **1**,
 A65-L to A66-L, Vol **6**, G117-L to G118-L,
 and the following *Addnl Refs:* 1) J. Boileau et
 al, "Tetranitroglycoluril for Explosives", *GerP*
 2435651 (1975) & *CA* **83**, 30483 (1975) [A
 90% yield prepn is claimed consisting of a one-
 step nitration of Dinitroglycuril with nitric acid
 contg 20.4 to 43.8% N_2O_5 at $< 10^\circ$. Also
 claimed is use of the compd in detonating cord,
 ie, 6.21g/m giving a deton vel of 9073m/sec] 2)
 Meyer (1977), 79–80 [Listed are the follow-
 ing properties for Dinitroglycoluril (or *Dingu*)
 and Tetranitroglycoluril (or *Sorguyil*):

Property	Dinitro- glycoluril	Tetranitro- glycoluril
Form	Colorl crystals	Colorl crystals
Gross formula	$\text{C}_4\text{H}_4\text{N}_6\text{O}_6$	$\text{C}_4\text{H}_2\text{N}_8\text{O}_{10}$
Molecular wt	232.1	322.1
Oxygen balance, %	–27.6	+5.0
Nitrogen, %	36.21	34.79
Density, g/cc	1.94	2.01
Detonation velocity, m/s	7580	9150
	at d 1.75g/cc	
Deflagration pt, °C	225–250	237
	(decompn begins at 130°)	
Impact sensitivity, kg m	0.5–0.6	0.15–0.2
Friction sensitivity, kg pistil load	20–30	–

3) J. Boileau et al, "Dinitroglycoluril-Based Explo-
 sives", *GerP* 2462330 (1976) [A prepn is claimed
 consisting of reacting glyoxal with urea followed

by nitration in fuming nitric acid contg 5–50 wt % N_2O_5 at -5 to 50°] 4) J.P. Kehren, "New Glycoluril Explosives", InstChemTreibExplos-Fraunhofer-GesPfungtal, Ger, 47–58 (1976) & CA 89, 113423 (1978) [Prepn of Tetranitroglycoluril is reported which consists of nitration of glycoluril in a sulfuric acid-free nitric acid- N_2O_5 mixt followed by washing in dichloromethane. The product has a density of 2.01g/cc, deton vel of 9150m/sec, and is reported as having properties comparable to the dinitro derivative]

Urushiodimethyletherozonides. See in Vol 8, O72-R

Utilization of Condemned or Surplus Military Explosives, Propellants and Pyrotechnics. See under "Reclamation of Energetic Material Components from Ordnance Ammunition" in Vol 9, R146-R, and "Renovation of Ammunition", R156-R

UZI. Israeli 9mm submachine gun. During the Arab Israeli War of 1948, immediately after the British mandate in Palestine ended, the Israelis found themselves without a reliable sub-machine gun. In 1949, Major Uziel Gal (for whom the UZI is named) of the Israeli Army started work on a weapon of this type intended for use by all branches of the armed forces of his country

The UZI is a blowback-operated gun using the system of advanced primer ignition in which the round is fired while the bolt is still traveling forward. This produces a reduced impulse to the bolt, and as a result this component can be designed to weigh less than half the amount that would be required for a static firing breech-block

For any given weapon the minimum overall length is the sum of the barrel length plus the length of the breech block behind the chamber plus the compressed return spring length. The UZI is 44.5cm long from the muzzle to the rear of the breech casing. This is less than the average length for a weapon of this type. The UZI also has a very pronounced advantage in that in its short length it achieves a 26cm barrel. This is managed by wrapping the bolt around the chamber and putting the breech face, not on the front face of the bolt, but 9.5cm further back. Thus, at the moment of firing, the bolt completely surrounds the rear end of the barrel except for a cut-out section on the right hand side which allows ejection of the fired case. A further advantage of this design is that if a round is fired early or a hang fire occurs, the soldier is protected from the effects of the bursting of the unsupported case by the wrap-around bolt

The magazine is inserted into the pistol grip. This has the advantage of making magazine changing very easy in the dark and also giving positive support to the magazine over a greater length than is usual. This makes for greater rigidity and more precise location. The gun stops firing with the bolt to the rear, and when the trigger is operated the bolt goes forward, collects a round from the top of the 25-round magazine, and feeds it over the bullet guide into the chamber. The cartridge is held in the magazine at an angle with the nose slightly elevated so that it does not line up with the fixed firing pin on the breech face until the cartridge case enters the chamber. At any time thereafter it can be fired when the frictional force between the case and the chamber wall produces the required resistance (Refs 2 & 3)

The characteristics of the UZI submachine gun are as follows (Ref 1):

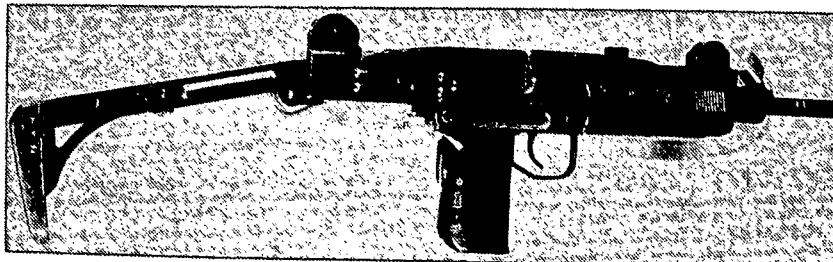

Fig 1 UZI 9mm Submachine Gun

Caliber. 9mm Parabellum

System of operation. Blowback, selective fire

Weight. 8.9 lbs w/loaded 25-round magazine and metal butt; 8.8 lbs w/loaded 25-round magazine and wooden butt

Length, overall. 25.2" (wooden-butt model, and metal-butt weapon with stock extended)

Barrel length. 10.2"

Feed device. 25, 32 or 40-round detachable, staggered box magazine

Sights. Front-truncated cone with protecting ears; Rear-L-type with setting for 100 and 200 yds

Muzzle velocity. 1310fps with 8 gram 9mm

Parabellum bullet

Cyclic rate. 650rpm

The UZI is manufd by Israeli Military Industries, Tel Aviv, Israel and Fabrique Nationale d'Armes de Guerre, Herstal, Liège, Belgium. It has also been reported as being in production in Rhodesia. It is in service in Belgium, Iran, Israel, The Netherlands, Rhodesia, Thailand, Venezuela, West Germany and elsewhere (Refs 2 & 3)

Refs: 1) E.C. Ezell, "Small Arms of the World", 11th Ed, Stackpole Books, Harrisburg, Pa (1977), 375

2) D.H.R. Archer, "Jane's Infantry Weapons", 4th Ed, Franklin Watts, NY (1978), 80-82

3) J. Weeks, Ibid, 5th Ed (1979), 71-72

V

V-1. Abbrev for *Vergeltungswaffe-eins*, Ger for "Revenge Weapon-One". A Ger WWII robot bomb provided with wings, a horizontal stabilizer, a vertical stabilizer, a rudder and elevators. Also called the "FZG-76" by the Ger and "buzz bomb" by the Brit. The V-1, first landed across the English Channel on 13 June 1944, was powered by a pulse-jet engine mounted on its back. Its overall length was 25'4", and its greatest diameter was 2'7". This missile was provided with complicated control devices and was kept on course by an automatic pilot. It had a speed of about 360 mph, a range of 150 miles, and it flew at a height of between 2000 and 3000 ft. Some 2000 of these robot bombs were directed against England in WWII, most of them against London

V-2. Abbrev for *Vergeltungswaffe-zwei*, Ger for "Revenge Weapon-Two". A large Ger liq-fueled rocket developed as a ballistic missile in WWII. Also called the "A-4" by the Ger. The V-2, first launched against England on 8 Sept, 1944, developed 60000 lbs of thrust from its rocket engine. From nose to exhaust tail, it measured 46 ft, and its diameter was about 5 ft. Shaped like an artillery projectile, it was without wings, but was subject to some guidance thru movable panels built into the four tail fins and thru graphite vanes extending into the exhaust stream. Launched vertically, it quickly reached a speed of 3600 mph and was then tilted in the direction of its target. It exhausted its fuel supply of 9 tons in 60 seconds, but reached an altitude of 60 miles with a range of 200 miles, and plunged earthward at about 1500 mph. Some 1115 V-2's were sent across the Channel in the last months of WWII

At first, both the V-1 and V-2 used mixts of TNT and Amm nitrate in their warheads. These were replaced by Amatol 39 (Dinitrobenzene 50, Amm nitrate 35 and RDX 15%) or Amatol 40 (Dinitroanisole 50, Amm nitrate 35 and RDX 15%). While Amatol 40 was suitable for cast-loading, the Amatol 39 gave occasional cavities when cast-loaded alone. In order to eliminate these cavities, the Amatol 39 was poured over pieces of *Biscuit Mixture A*, which consisted of Amm nitrate 50, technical Ca nitrate 25, PETN 10 and RDX 15%. Still later in the war, when the shortage of aromatic compds became acute, it was proposed that non-nitro-

aromatic mixts be employed, viz, technical Ca nitrate 55, powdered peat 5, Al powder 10 and 30% of a 90/10 mixt of Methylnitrate and benzene (Myrol)

Refs: 1) L.E. Simon, "German Research in World War II", J. Wiley & Sons, NY (1947), 31-35 2) B.T. Fedoroff, "Dictionary of Explosives, Ammunition and Weapons (German Section)", PATR 2510 (1958), 213-15 3) J. Quick, "Dictionary of Weapons and Military Terms", McGraw-Hill, NY (1973), 484 4) C. Chant, Ed, "How Weapons Work", Henry Regnery Co, Chicago (1976), 239-41

Vacuum Stability Test. See in Vol 1, "Introduction", IV & XXVI, and under "Stability and Instability of Explosives" in Vol 6, E438-R
Addnl Refs: 1) A.J. Clear, "Standard Laboratory Procedures for Determining Sensitivity, Brisance and Stability of Explosives", PATR 3278 (Rev 1) (1970), 18-28 2) R. Meyer, "Explosives", Verlag Chemie, NY (1977), 313 ["This test, which has been developed in the USA and has been adopted by several countries, is a modification of the Taliani test (see Vol 1, XXIV & XXV), in which the gaseous products of the reaction are determined volumetrically rather than by manometry. The test, which is carried out at 100°C (212°F) for single base propellants and at 90°C (194°F) for multiple based propellants, is terminated at the end of 40 hours, unlike the Taliani test, which is interrupted after a given pressure or a given volume has been attained. The vacuum test is used for compatibility testing, applied as a so-called reactivity test. The compatibility between the explosive and the contact material (adhesive, varnish, etc) is tested by determining the gases liberated by the explosive alone, by the contact material alone, and by the two together. The measure of compatibility (reactivity) is the difference between the sum of the gas volume liberated by each component separately, and the gas volume obtained after storing the explosive and the contact material together. If this difference is between 3 and 5 ml, the compatibility is considered 'uncertain'; above 5 ml, the two materials are incompatible."]

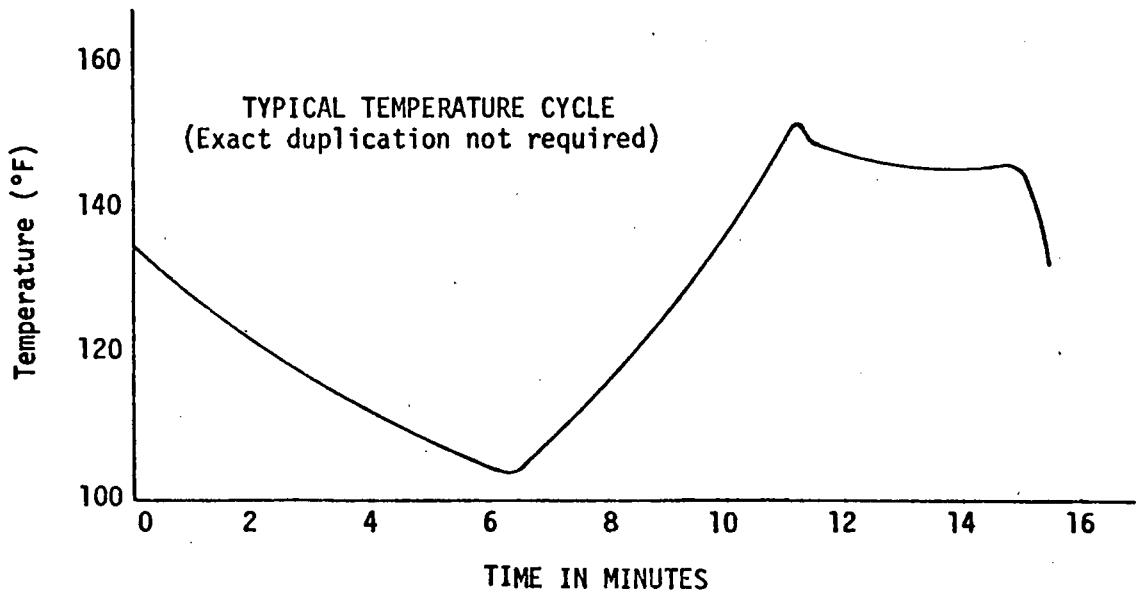
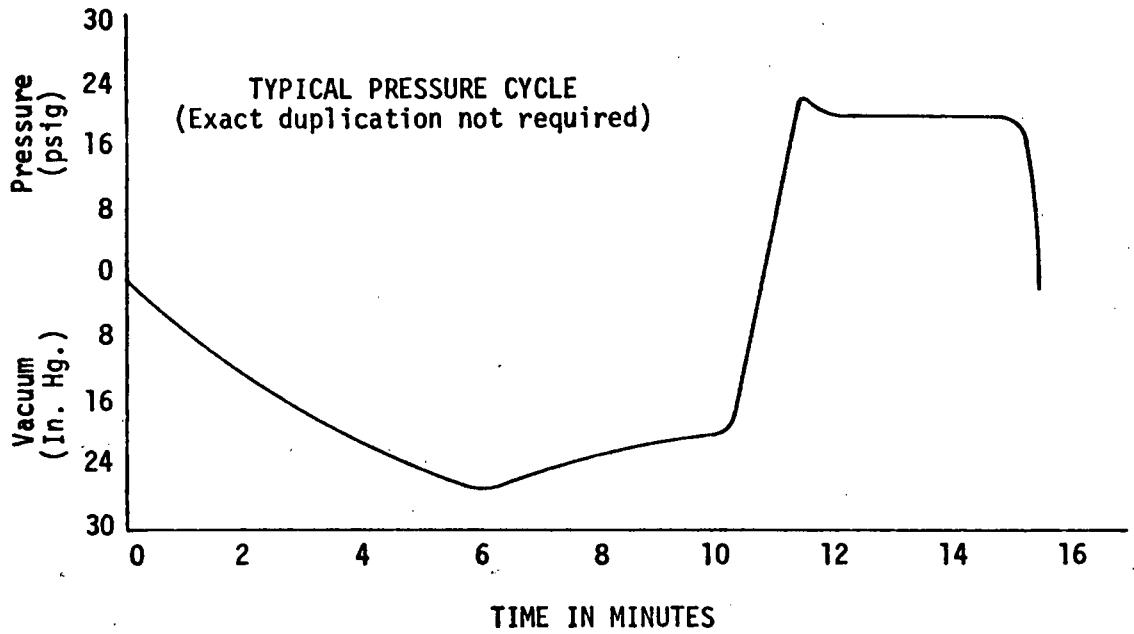

Fig 1 Typical Test Curves of Pressure and Temperature Versus Time

Vacuum-Steam-Pressure Test. A special aging test which has been used successfully in the USA to accelerate aging to produce the effects of 6-month tropical exposure on certain types of sealed fuzes. It is primarily a development test which can be used during production

The test consists of subjecting bare fuzes to 1000 fifteen-minute consecutive cycles in a vacuum-steam-pressure environment. The 1000 cycles takes about 10 days of continuous running time. The basic cycle consists of temperature-humidity cycling superimposed on pressure cycling in a test chamber with a salt laden atmosphere. Representative curves of temperature and pressure are shown in Fig 1

This test is designed to accelerate the aging and failure-mode processes of bare fuzes by (1) using increased levels of pressure and vacuum beyond those encountered in normal service use, and (2) decreasing the time elements by using an environmental cycle of fifteen minutes, continuous to a total of 1000 cycles. This accelerated test achieves the same end-failure-modes (for certain types of sealed fuzes) which are experienced in a normal 6 months of tropical storage or ready use conditions. The types of fuzes for which this test is applicable are non-breathing sealed designs (soldered, welded, brazed, adhesive sealed) which are made of case materials that have structural yield points beyond the force levels exerted by the vacuum-pressure range applied by the test conditions

The fuzes must be safe and operable following this test. Breakdown, inspection, and static tests, together with engineering judgment, are usually the basis for the decision

Ref: Anon, "Military Standard: Fuze and Fuze Components, Environmental and Performance Tests for", MIL-STD-331A (15 Oct 1976)

Valve, Explosive Calculations. In the past, explosively actuated valves have been designed on an empirical basis because the interactions and forces involved in a valve operation were not fully understood. However, this design approach was satisfactory in that the size and design of the valves permitted a more than adequate amount of expl to be used to ensure proper operation of the valves. That is, the driving force available from the extra expl pro-

vided a "design cushion" that helped compensate for variations in the unknown parameters. Eventually, however, systems were proposed which required valves of smaller size and different design that could not tolerate excessive amounts of expls

The first analytical effort was *MAVIS*, a computer program which modelled all the interactions present in a valve and calculated the forces and velocities involved. The data used to confirm *MAVIS* were some preliminary data acquired in 1968 on a valve design of that era. A part of the expts had been performed on actual valve hardware. However, modifications were required on those valves in order to record the data, and were such that they also affected the actual operation of the valves. Therefore, even though data were available for comparison with *MAVIS*, they were (1) related to the earlier, larger valves, and (2) obtained from modified hardware configuration. Data were therefore needed which would supply both basic information on the operation of the mini-valve as well as the needed data for correlation with *MAVIS*

Ref 1 describes a technique based upon the **Velocity Interferometer System for Any Reflect- or (VISAR)** with which the plunger velocities were measured in actual unperturbed hardware. The monitoring of the plunger velocity would give a direct indication of the forces involved at each valve interaction, since the forces influence the velocity of the plunger. These expts proved the capability of measuring valve interactions by means of a *VISAR* and provided empirical information and data for analytical studies (Ref 2)

Refs: 1) R. Ng, "VISAR Measurements of Velocities in Explosive Valves", **SAND 76-8048**, Sandia Laboratories, Albuquerque, NM (1976)
2) G. Cohn, Ed, *Expls & Pyrots* 10 (no 11) (Nov 1977)

Vanadium. V; at w 50.94; at no 23; valences 2, 3, 4, 5; two naturally occurring isotopes: ^{51}V (99.75%), ^{50}V (0.25%), the latter is radioactive ($T_{1/2} = 6 \times 10^{15}$ yrs); artificial isotopes: 46-49 and 52-54; lt grey or white lusterous powder, body-centered cubic cryst; mp 1917°; bp 3380°; d 5.96g/cc; RI 3.03. Reacts with hot sulfuric acid, hydrofluoric acid, nitric acid and aqua regia; not sol in w. CA Registry No [7440-62-2].

V occurs to the extent of 0.01% abundance in the earth's crust in ores such as patronite, roscoelite, carnotite and vanadinite. Prepn is either by redn of V pentoxide with Ca (99.8+ % yield) or by electrolytic refining using a molten salt electrolyte contg V chloride

V has a ΔH_f of 100kcal/g-mole, and a sp heat of 0.12cal/g/°C at 20 to 100° and 38.50J/mole/°K at 1850°K

Some use has been made of V ores in pyrot smokes (Ref 5). V is the parent element of the expl and energetic compds entered below. Metallic V is non-toxic (Refs 1, 6, 7, 13, 14, 15, 16 & 18)

Divanadium Dedecarbonyl. $V_2(CO)_{12}$, $C_{12}O_{12}V_2$; mw 438.06; dk blue volatile liq which readily sublims at RT and atm pressure. Sol in eth and hydrocarbons. Prepn is by reaction of V ditoluene with C monoxide. The compd is pyrophoric (Ref 8, p 47)

A word here on the *toxicity* of V compds: The compds act chiefly as irritants to the conjunctivae and respiratory tract, turning the tongue green. Exptl biochemical studies show that V compds inhibit cholesterol synthesis and the activity of the enzyme cholinesterase. Prolonged exposure to V compds may lead to fatal pulmonary involvement. The Threshold Limiting Values of these compds, in particular the highly toxic pentoxide, are dust, 0.5mg/CM; fumes, 0.05mg/CM (Refs 7, 16 & 18)

Vanadium Bis Cyclopentadienyl Acetylacetic-acid Ethyl Ester Perchlorate. $[(C_5H_5)_2V(C_6H_9O_3)] \cdot ClO_4$, $C_{16}H_{19}O_7ClV$; mw 409.74; OB to CO_2 -134.72%; olive grn ndles. Prepn is by reacting V cyclopentadienyl dichloride with Ag perchlorate and reacting the product with the ethyl ester of acetylacetic acid at 45°. The yield is vac filtered and w washed. Gmelin terms the perchlorate a high expl (Ref 1, *Erganzungswerk*, p 39)

Vanadium Bis Cyclopentadienyl Isoselenocyanate. $(C_5H_5)_2VKCNSe$, $C_{11}H_{10}NKSeV$; mw 325.22; OB to CO_2 -132.83%; grn-brn crysts. Sol in trichlormethane. Prepn is by reacting V cyclopentadienyl dichloride with K isoselenocyanate

in acet-eth (1 to 1) at boiling, and then cooling the reaction mixt to -70°, thus pptg the product in 80% yield. Upon ign the compd explds with great brisance (Ref 1, *Erganzungswerk*, p 44)

Vanadium Hydride. $VH_{0.40}$ to 0.70; lustrous metallic grey cryst. Prepn is by thoroughly degassing V at red heat in a vac and then heating it in an atm of extremely pure H_2 . Accdg to Gmelin (Ref 1, Teil B, Lief 1, p 8), contact with w, C dioxide, chlorinated hydrocarbons and similar common solvents lead to brisant explns (Refs 1, 2 & 6). For more information on hydrides see in Vol 7, H211-R to H212-R

Vanadium Trinitrate Oxide. $VO(NO_3)_3 \cdot NO_{10}V$; mw 224.95; grn-blue ndles. Prepn is by reacting V pentoxide with either oxalic acid in dil nitric acid at 80-90°, or with N pentoxide. Accdg to Bretherick (Ref 19), this powerful oxidizing and nitrating agent ignites hydrocarbons and organic solvents on contact, and acts like fuming nitric acid with paper, rubber, and wood (Refs 1, 4 & 19)

Vanadyl Azide Dichloride. $VO(N_3)Cl_2$, Cl_2N_3OV ; mw 179.88; solid. Reported as being an expl by Bretherick (Ref 19)

Vanadyl Azide Tetrachloride. $V(N_3)Cl_4$, VCl_4N_3 ; mw 244.78; brn solid. Prepn is by bubbling a mixt of Chlorine azide and nitrogen thru a soln of V tetrachloride in C tetrachloride at RT. The compd is not only very sensitive to friction and impact, but also explds on thermal shock (Ref 17)

Vanadyl Azide Trichloride. $VO(N_3)Cl_3$, Cl_3N_3OV ; mw 215.33; cryst. Sol in V oxytrichloride. Prepn is by bubbling a mixt of chlorine azide and nitrogen thru V oxytrichloride at RT. The compd deflagrates with great vigor on being subjected to thermal shock (Ref 17)

Vanadyl Trichloride. (or Vanadium oxytrichloride). $VOCl_3$; mw 173.32; violently hygroscopic yel liq which emits red fumes on exposure to moist air; mp -77± 2°; bp 126.7°; d 1.829g/cc. Sol in acetic acid, liq Br_2 , ethanol and eth. CA Registry No [7727-18-6]. Prepn is by ign of V tetrachloride (Ref 9). Accdg to Ref 8, the

compd forms orange smoke when in contact with atmos moist; the smoke density is increased by addn of Ti tetrachloride; it also reacts with sulfuric acid to yield $\text{VOCl}_3 \cdot \text{SO}_3$ which with moist air forms a dense white smoke. The compd has a ΔH_f° of -177kcal/mole

Bachusky and Levesque suggest in their patent (Ref 10) the use of VOCl_3 to form an intense orange smoke by releasing a mixt of VOCl_3 (70 to 90) and V_2O_5 (10 to 30%) into the atm by means of a 10-gauge shotgun shell. They claim that the smoke will persist until normally dispersed by the atm. Similarly, Wall (Ref 12) reports that the best pyrot spotting charge developed using VOCl_3 for use in practice bombs is the undiluted V oxytrichloride. The smoke generated will persist as an orange cloud at RH's below 75% for 15 secs or more, but at higher RH's the orange color fades to white within 7 secs (Refs 3, 8, 9, 10, 11, 12, 15 & 19)

Vanadyl Triperchlorate (or Vanadyl perchlorate).

$\text{VO}(\text{ClO}_4)_3$, $\text{Cl}_3\text{O}_{13}\text{V}$; mw 356.29; golden yel crystals; f pt $21-22^\circ$. Decompd by C tetrachloride. Prepn is by reacting V pentoxide with Cl_2O_6 at 5° . The golden yel liq product is then distld off under high vac at 33.5° , and allowed to crystallize at $21-22^\circ$. The compd is a powerful oxidant. It ignites org solvents on contact and explds with great violence above 80° (Refs 1, 4 & 19)

Refs: 1) Gmelin, Syst No 48, Teil A & Teil B (Lieferung 1 & 2) (1967); Teil A (Lieferung 1) & Teil A (Lieferung 2) (1968); & Erganzungswerk (Band 2) (1971) 2) D.T. Hurd, "... Chemistry of the Hydrides", John Wiley & Sons, NY (1952), 185 3) F.A. Cotton, ChemRevs 55, 560 (1955) & CA 49, 10873 (1955) 4) M. Schmeisser, AngChem 67, 495 & 499 (1955) & CA 49, 15590 (1955) 5) J. DeMent, "Composition for Smoke Production", USP 2995526 (1961) & CA 55, 25100 (1961) 6) G. Brauer, Ed, "Handbook of Preparative Inorganic Chemistry", Vol 2, 2nd Ed, Academic Press, NY (1965) 7) Sax (1968), 1222 ff 8) J.R. Gibson & J.D. Weber, "Handbook of Selected Properties of Air- and Water-Reactive Materials", RDTR 144, USNAVAMMDEP, Crane (1969) 9) I. Laszlo et al, "Continuous Production of Vanadyl Chloride", HungP 3587 (1972) & CA 76, 156246 (1972) 10) W.J.

Bachusky & R.J. Levesque, "Packaged Composition for Generating Colored Smoke", CanP 883774 (1971) & CA 76, 5470 (1972)

11) J.C. Bailer et al, Eds, "Comprehensive Inorganic Chemistry", Vol 3, 507-09, Pergamon Press, Oxford (1973) 12) R.H. Wall, "The Effect of High Relative Humidities on Orange Spotting Charges Based on Vanadium Oxytrichloride", DREV-TN-1077/73, ARDE, Canada (1973) 13) C.W. Beckett, "Thermodynamics of Chemical Species Important to Rocket Technology", AFOSR-TR-75-0596, Contract ISSA-74-0001, NBS, Washington (1974) 14) M. Farber, "Thermodynamic Properties of Rocket Combustion Products and Nozzle Materials", AFOSR, Contract F44620-69-C-0071 (1974) [AD-777180] 15) Merck (1976), 1273 (No 9575) 16) E.R. Plunkett, "Handbook of Industrial Toxicology", Chemical Publishing Co, NY (1976) 17) H.D. Fair & R.F. Walker, Eds, "Energetic Materials—Physics and Chemistry of the Inorganic Azides", Vol 1, 43, Plenum Press, NY (1977) 18) M. Sittig, "Hazardous and Toxic Effects of Industrial Chemicals", Noyes Data Corp, Park Ridge (1979), 439-40 19) Bretherick (1979), 1160

Vandal. The US Navy's interim supersonic target for ship defense against *Cruise* missiles. It is a modification of the *Talos* naval missiles, and will serve as a low-cost target into the early 1980's. The modification to the normal *Talos* round includes the provision of a new tracking beacon, a radar altimeter, an on-board command receiver, plus air frame and fuel system modifications to simulate a variety of threat altitudes and speeds

A pre-production contract was started in Sept 1977, with full production following in 1978. Deliveries will continue from 1979 until 1983. The manufacturer is the Bendix Corp, Aerospace Systems Division, Mishawaka, Indiana, USA

Ref: R.T. Pretty, Ed, "Jane's Weapon Systems, 10th Ed, 1979-80", Franklin Watts, NY (1979), 182

Van Pittius Explosives. See under "Pittius Explosives" in Vol 8, P305-R

Vapor Explosions

I. Introduction

This title is somewhat misleading. The following article is primarily concerned with expl reactions of fuel mists (and/or vapors) with oxygen of the air. The article does not include consideration of *flash vaporizations* that occur when very hot substances (molten Al for example) come into contact with a "volatile" liquid (eg, water), nor does it concern itself with "steam-boiler" type explns. Thus the subject matter of this article deals with rapid fuel oxidations with the oxidant usually provided by the oxygen of the air, though reactions of *monopropellant* type mists will also be considered. Most of the fuels of interest are liquids at ordinary ambient conditions

There is a two-fold motivation for studying these explns. From a military point of view, *deliberately produced* fuel/air explns can be very destructive to a variety of targets. Furthermore, this destruction can cover a wide area, yet the payload can be only a fraction of that required for bombs using conventional high explns. On the other hand, *accidental* fuel/air explns (eg, in chemical plants handling combustible liquids) can be just as destructive, and understanding of the nature and consequences of these explns is needed to prevent loss of life and property. The common ground between these divergent points of view is of course the potential destructiveness of vapor explns. In military applications, ways and means to produce and enhance the destructiveness are sought, whereas in industrial applications ways and means of suppressing these explns are critically important

As implied above, this article will concern itself with the nature and destructiveness of reactions of fuel mists and oxidants. Two aspects of such reactions will be examined, namely deliberately established and accidental. Numerous studies have been devoted to elucidating the establishment and enhancement of deliberate vapor explns because of military interest in this subject. Some of the results of such studies are obviously applicable to accidental explns, which have been examined primarily in a phenomenological fashion. Consequently, in what

follows, we will first describe the common ground between deliberate and accidental vapor explns and then consider their specific aspects

II. Initiation Stimuli of Vapor Explosions

Little needs to be said concerning the initiation stimuli of vapor explns. In most respects, the initiation stimuli for combustible fuel/air clouds are similar to those of gaseous or condensed explns. These are: *Sparks, Flames, Other Explns, Hot Surfaces* and *Compression Heating*. The latter refers to compression without generation of a shock that can trigger vapor explns. It is the initiation mechanism used in diesel engines. All of these stimuli can cause *accidental* vapor explns. In *deliberate* vapor explns the initiation stimulus is almost invariably the detonation of a condensed expl. There is an additional means of initiation which appears to be specific to fuel/air explns. Small scale expts (to be described subsequently) indicate that *dispersion of strong oxidizing agents* (eg, ClF_3) into a fuel/air cloud can initiate expln of the cloud. The mechanisms of initiation will be discussed in Section V

III. Damage Potential of Vapor Explosions

Before proceeding with a quantitative description of these effects, we will examine the subject of potential damage by vapor expln in a qualitative manner. Once initiated, a fuel mist-air expln produces effects that are similar to gaseous detonations. Thus the equilibrium pressure is of the order of 20 atm, which is comparable to gaseous detonation, but about ten-thousand-fold less than the CJ pressure of a condensed expl. As in the case of gaseous detonations, this large difference is accounted for by an initial density difference of about one-thousand-fold for fuel/air mists vs condensed expls, and by the non-ideal behavior of the product gases of condensed expls as compared to the nearly ideal behavior of fuel/air expln products. Why then, might one ask, are fuel/air explns so destructive when the pressures they generate are so much lower than those of condensed expls? The answer lies in the dimensions of most fuel/air explns, which usually are much larger than those of condensed expls. Whereas at some ten or so charge radii from its original position the pressure in air generated by a condensed expl has decayed to a small fraction of

its initial value, at a comparable distance the pressure in air generated by a fuel/air expln is close to its initial value. Furthermore, the pressure pulse duration of fuel/air explns is generally longer than that of condensed expl detonations. Thus the impulse created by the former can be appreciably greater than that of the latter

The heats of reaction, Q , on a per unit weight basis, are roughly comparable for condensed expls and fuel/air explns, *provided the weight of air* involved is taken into account. When fuel droplets are dispersed in air to create a mist and then detonated, the air is, in effect, furnished gratis, in that it does not have to be carried along as part of the expl device. On this basis (air-free) the heat of reaction Q' of fuel/air explns can be appreciably greater than that of condensed expls. This is an important consideration in military applications of fuel/air explns

We now turn to quantitative aspects of the destructiveness of fuel/air explns. Fishburn (Ref 9) used numerical solutions based on the von Neumann-Richtmeyer *artificial viscosity* technique to determine flow fields of fuel/air detonations. He was then able to construct dimensionless charts of overpressure, static and dynamic impulse, and specific internal energy, in air, at various distances from the expldg cloud. In all cases, the flow was assumed to be adiabatic and inviscid, and the reactants, products and surroundings were assumed to be ideal gases. Three situations were examined: 1) centrally initiated CJ detonations; 2) edge-initiated spherical implosions; and 3) constant volume energy release followed by sudden venting to the atm. To follow Fishburn's results we need definitions for the notation that he used and the parameters he presents. These are shown in Table 1, taken from Appendix A of Ref 9:

Table 1

Nomenclature

D_{CJ}	scaled C-J detonation Mach number = $\gamma_0^{1/2} M_{CJ}$
E_{final}	final total internal energy of explosion products
E_t	total explosion energy
I_d	dimensionless dynamic impulse

$$I_d = \frac{\left(\gamma_1 \frac{V_1}{P_0}\right)^{1/2}}{\left(\frac{4}{3}\pi R_c^3 \frac{Q}{P_0 V_0}\right)^{1/3}} \int_0^\infty \frac{1}{2} \frac{u^2}{V} dt$$

I_s dimensionless static impulse

$$I_s = \frac{\left(\gamma_1 \frac{V_1}{P_0}\right)^{1/2}}{\left(\frac{4}{3}\pi R_c^3 \frac{Q}{P_0 V_0}\right)^{1/3}} \text{Max} \int_0^\infty (P - P_0) dt$$

P pressure

ΔP dimensionless overpressure = $\frac{P}{P_0} - 1$

Q exothermic energy of the combustion process per unit mass

R radius

R_c initial charge radius

R_t final radius of explosion products

T dimensionless time = $t/R_c/\sqrt{P_0 V_0}$

e_{final} final specific internal energy of explosion products

e_0 initial energy of explosive reactants =

$$Q + \frac{P_0 V_0}{\gamma_0 - 1}$$

t time

V specific volume

γ adiabatic exponent

λ dimensionless distance based on energy = $(R/(E_1/P_0))^{1/3}$

Subscripts

0	initial values within the charge ($P_0 = 1$ atm)
1	values in the surroundings
2	values in the explosive products
CJ	values at the C-J plane
CV	values for constant volume explosion

for the conditions: $\gamma_2 = 1.253$

$$\frac{Q}{P_0 V_0} = 36.35, \quad \frac{V_{CJ}}{V_0} = 0.5693$$

$$D_{CJ} = 6.511$$

and $\gamma_1 = 1.377$; $V_1 = V_0$, Fishburn's results for overpressure, static impulse and dynamic impulse are shown in Figs 1, 2 and 3, respectively. The same symbols are used thruout, and in each figure the blast effects of a point source detonation (at the same level of energy release as the fuel/air expln) are given for comparison

The characteristic feature of such gaseous explns is that the peak pressure of the air blast wave, which has an initial pressure at $R/R_c = 1$ of 18.1, decays rapidly near the edge of the charge, approximately as the inverse radius to the tenth power. The decay is gradual at farther distances. Static impulse also decays rapidly near the cloud



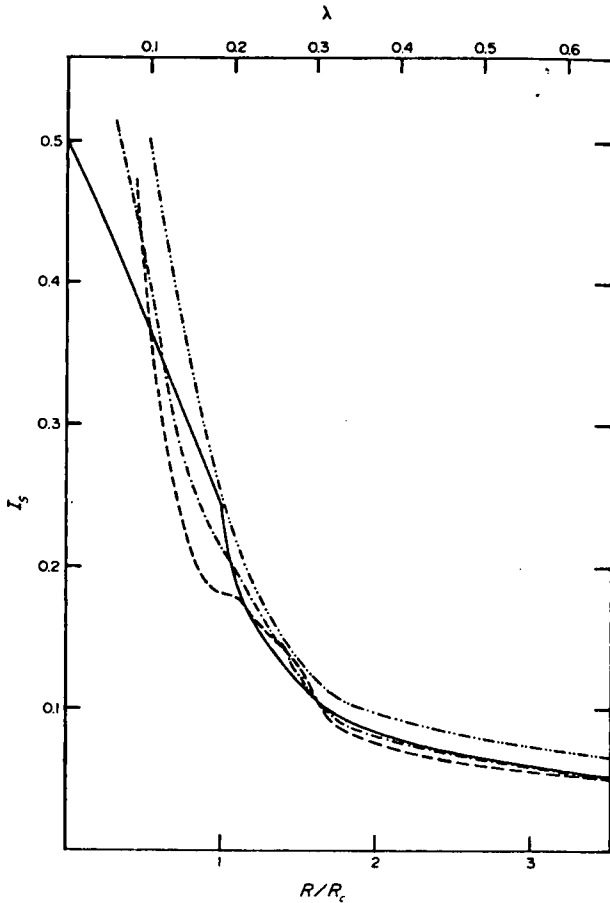

Fig 1 Calculated Peak Overpressure vs Dimensionless Radius for Calculations with $Q/P_0 V_0 = 36.35$. Calculations model centrally initiated detonation (solid line), implosion (dashed line), high pressure sphere (chain dotted) and ideal point source (double chain dotted)

Bruceton tests and statistical analysis as both normal and logistic distributions (Ref 8) and more gradually at larger radii. Dynamic impulse reaches a maximum at the edge of the charge and decays slowly with distance

In an implosion, the detonation becomes strongly overdriven in the neighborhood of the origin. With a finite diameter charge the detonation products vent into the surroundings before the detonation reaches the origin. Thus the resulting blast wave is composed of both the original expanding shock and the wave reflected from the center. Implosion generates low peak pressures near the charge, but these become slightly greater than those generated by an expln for $R/R_c \geq 2$ (see solid and dashed

curves in Fig 1). Computed static impulses for expln and implosion are quite similar for $R/R_c \geq 1$ (see Fig 2). Computed dynamic impulse is greater for implosions than expln though the difference is small for $R/R_c \geq 1.5$ (see Fig 3). In all three figures the point source parameters are greater than either the expln or implosion parameters. However, since comparisons are made at a given R/R_c , the dimensions of the "point source" must be very large indeed to be comparable with the dimensions of a fuel/air cloud. For $R/R_c \geq 1$, the behavior of the constant volume energy release suddenly vented into the surroundings is quite similar to that of an expln

The energy distribution of the products when the shock front is at $R/R_c = 6$ is shown in Fig 4 for the same initial conditions and symbols as above. The work done in all three situations is substantially the same

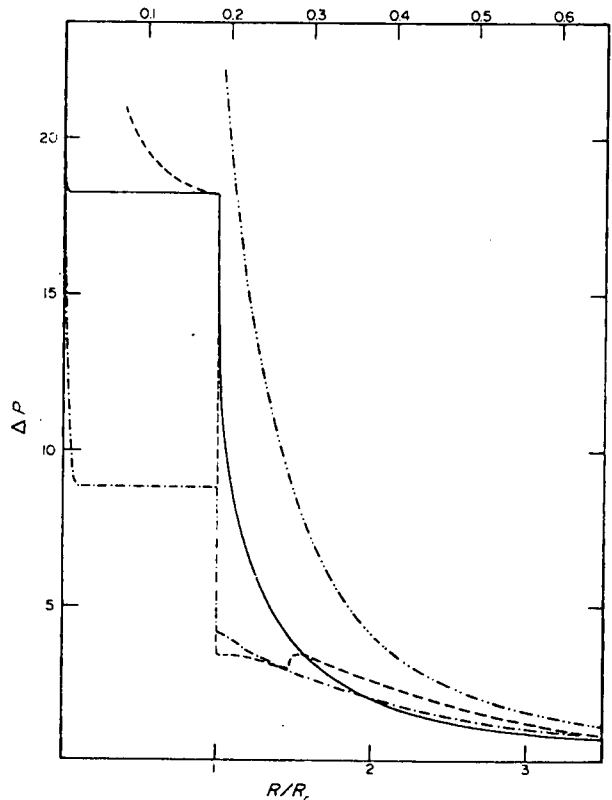

Fig 2 Calculated Static Impulse vs Dimensionless Radius for Calculations $Q/P_0 V_0 = 36.35$

N
P
B
B

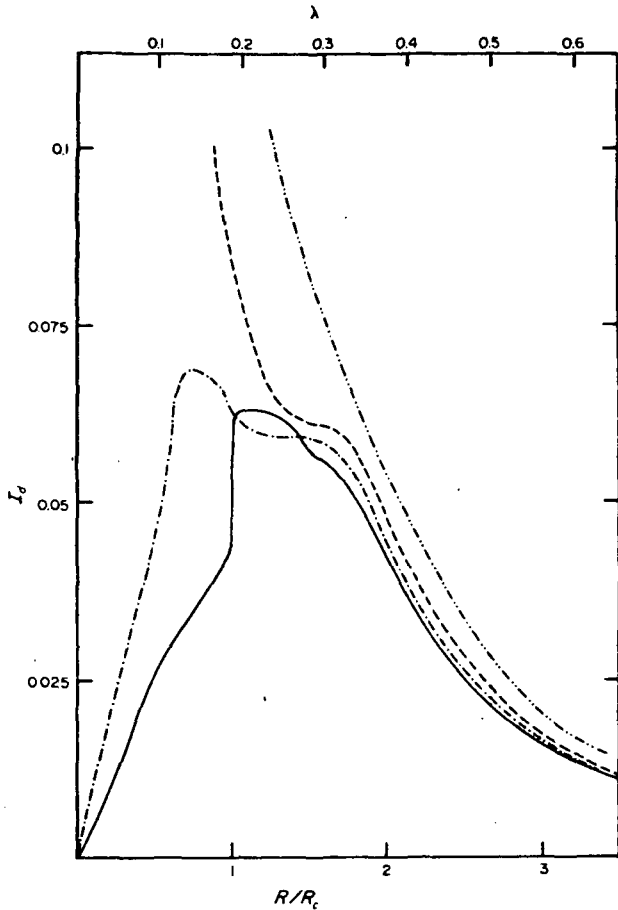

Fig 3 Calculated Dynamic Impulse vs Dimensionless Radius for Calculations with $Q/P_0V_0 = 36.35$

Fishburn also computed peak overpressures for large-scale and small-scale deflagrations. His initial conditions were:

CH4

$$\frac{Q}{P_0V_0} = 72.61, \frac{D_{CJ}}{V_0} = 0.5439 \text{ and } D_{CJ} = 6.291$$

The deflagration cannot be scaled in terms of charge size since the flame constantly accelerates. A computation was carried out for the large charge only, so that the dimensionless flame position was described by

$$\frac{R}{R_c} = 0.22824T^{1.36}$$

By contrast the flame position for the small charge would be given by

$$\frac{R}{R_c} = 0.179168T^{1.36}$$

Results are shown in Fig 5. The exptl deflagration data are for H_2/O_2 deflagrations (Ref 3a). Fishburn suggests that the exptl large-scale deflagration may in fact be a partial detonation

For the above conditions, Fishburn's computed static impulses for detonation and deflagration are shown in Fig 6. Note that impulses are essentially identical for $R/R_c \geq 2$

Additional examination of the damage potential of FAE (fuel/air expl) clouds was made by Slagg et al (Ref 5). They used the same computational methods as those of Ref 9. Their results for ethylene oxide FAE's are presented in Figs 7, 8 and 9

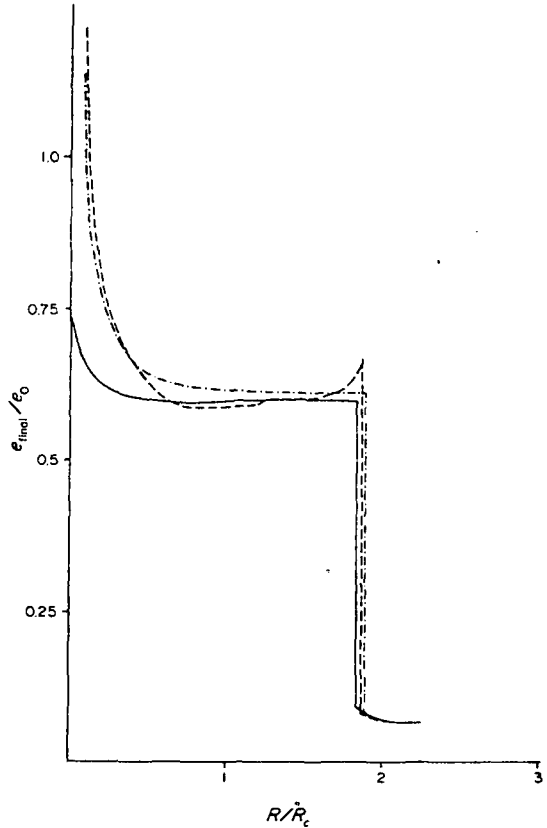

Fig 4 Calculated Final Energy Distribution of the Product Cloud vs Dimensionless Radius for Calculations with $Q/P_0V_0 = 36.35$

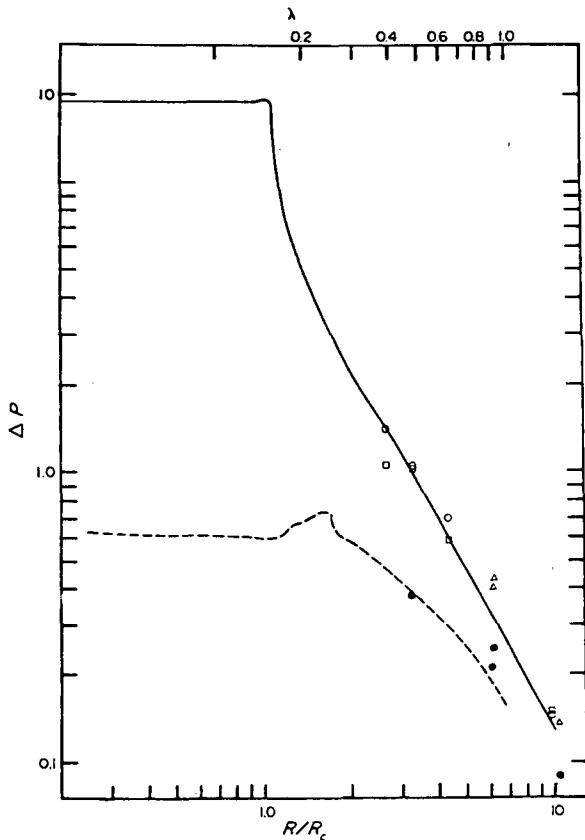

Fig 5 Calculated Overpressure vs Dimensionless Radius for Detonation (solid line) and Deflagration (dashed line) of Large Hydrogen-Oxygen Charge with Large Detonation (O), Small Detonation (Δ), Large Deflagration (\square) and Small Deflagration (\bullet) (data from Ref. 3a).

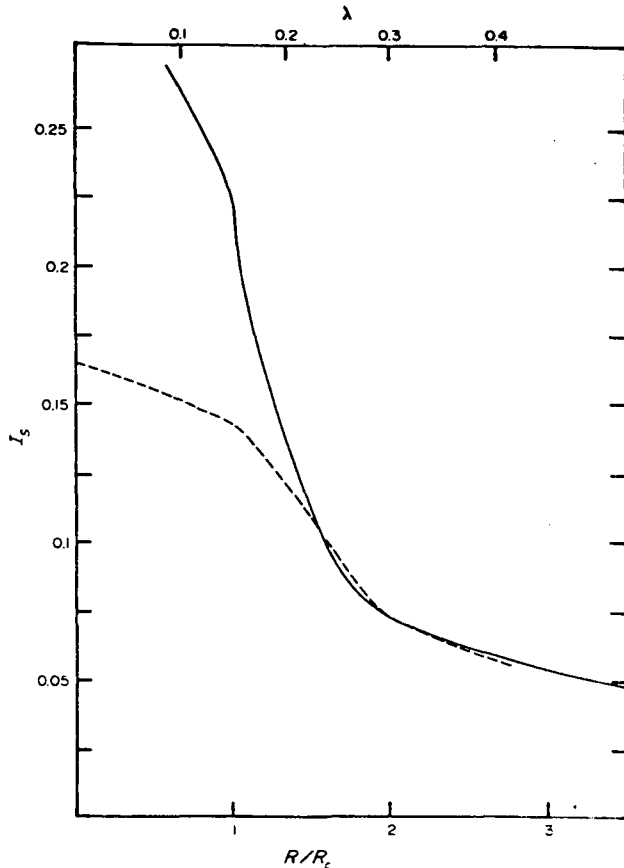

Fig 6 Calculated Static Impulse vs Dimensionless Radius for Detonation (solid line) and Deflagration (dashed line) of Large Hydrogen-Oxygen Charge

Fig 7 illustrates the propagation of a detonation thru a fuel/air cloud. Upon reaching the edge of the cloud the detonation ceases and a blast (shock) wave propagates into the surrounding air. The curvature of the detonation is due to rarefaction waves which reduce the strength of the detonation wave by altering the flow. It is the shock waves associated with the detonation and blast that are capable of causing damage

Fig 8 shows that on an *equal weight basis* the ethylene oxide (EO) FAE generates a considerably larger overpressure than Pentolite, but as in Fig 1, Pentolite generates much greater overpressures on an *equal energy basis*

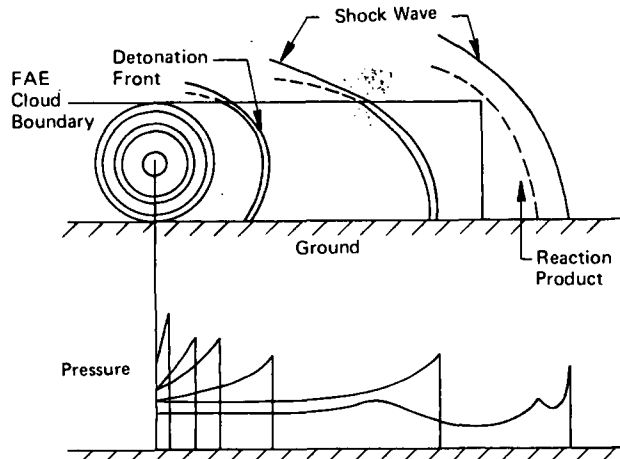

Fig 7 The Time Dependent Histories of the Detonation Wave Front Shape and Pressure

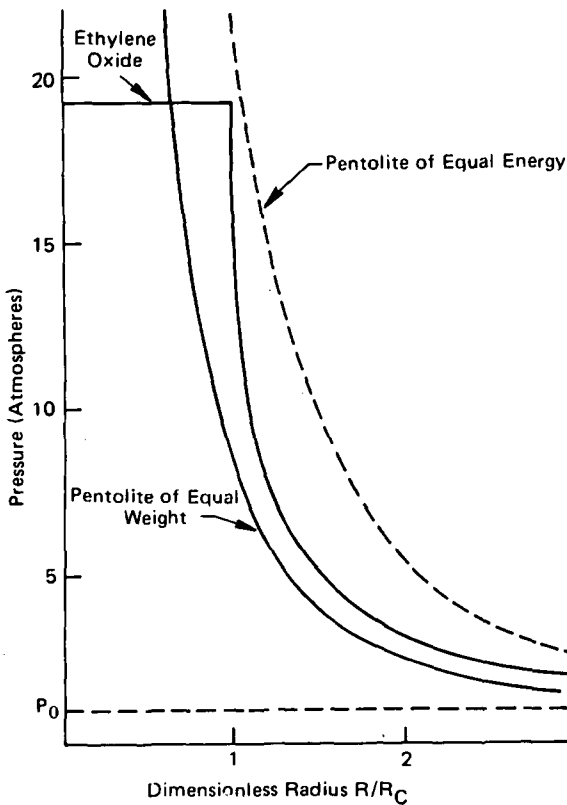

Fig 8 Peak Pressures Produced by Ethylene Oxide and Pentolite Detonations. (Cloud Radius = R_C)

Fig 9 presents static and dynamic impulses of spherical and cylindrical EO FAE's and compares them (on an equal energy basis) with Pentolite and point source detonations. Note the greatly enhanced impulses generated by cylindrical FAE's, as well as the greater impulses of FAE's vs Pentolite or point source detonation for $R/R_C \leq 1.5$

Slagg et al point out that theoretical performance of FAE clouds may not be realized in practice: "The available energy of a fuel-air explosive may not be realized due to the rarefaction wave (Fig 7) which can alter the flow field and thereby remove energy from the blast or detonation wave. At present, theoretical calculations cannot be performed taking this factor into consideration due to the lack of a realistic physical model. In addition, comparisons between calculations of theoretical outputs and experiments are difficult at this time because the fuel-

oxidizer ratio as a function of location is not sufficiently defined. Only when the parameters of cloud geometry and stoichiometry are known can the validity of a theoretical model be tested"

A dramatic illustration of the damage produced by fuel/air explns is provided in Table 2, taken from Ref 15. A similar tabulation is also given in Ref 10. The key to Table 2 is as follows: Tox = Toxic; FB = Fireball; BLEVE = Boiling Liquid Expanding Vapor Expln; Det = Detonation; CVE = Confined Vapor Expln; UCVE = Unconfined Vapor Expln. It is the last three designations (Det, CVE, and UCVE) that are of particular interest to us. Of even greater interest are the catastrophic events marked by us with an "X". These events leave no doubt about the enormous damage potential of fuel/air explns

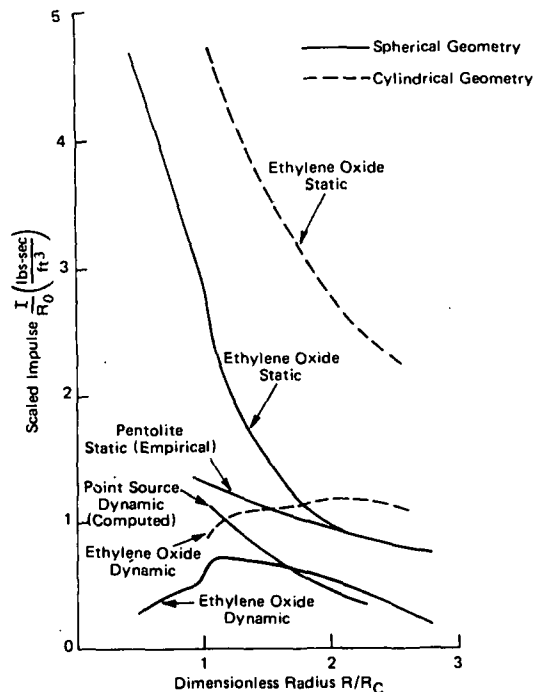

Fig 9 Impulses Produced by Detonations from Spherical and Cylindrical Clouds of Ethylene Oxide, Equivalent Energy of Pentolite and a Point Source. (Cloud Radius = R_C)

Table 2
Accidental Fuel/Air Explosions (from Ref 15)

Place	Date	Material Involved	Damage	Key
Hull, UK	1921	Hydrogen	Windows were broken in a 2-mile radius. The blast was felt in a 5-mile radius and tremors for 50 miles	CVE
Cleveland, USA	1944	LNG	136 killed, surrounding streets swept with burning gas. Windows broken, pavements raised up and manhole covers blown over buildings. Fire engine blown into the air	FB CVE X
Ludwigshafen, Germany	1948	Dimethylether	245 killed, 2500 injured. Railcar ruptured alongside a dimethyl plant followed by an explosion and fire (Damage £8M)	UVCE
Warren Petroleum, Port Newark, USA	1951	Propane	No record	UVCE
Wilsum, Germany	1952	Chlorine	7 people died when 15 tonnes were released from a storage tank	TOX
Whiting, Indiana, USA	1955		2 died, 30 injured following a detonation in a hydroformer. Storage tanks punctured by shrapnel buried for 8 days (£8M)	DET
New York, USA	1956	Ethylene	40,000 cu ft of ethylene was released into the atmosphere causing aerial explosion	UVCE
Niagara Falls, New York State, USA	1958	Nitromethane	200 injured when a rail tanker car detonated forming a large crater (£0.5M)	DET
Signal Hill, California, USA	1958		2 killed when vapor from a frothing tank which overflowed ignited and damaged 70% of the process area	FB
La Barre, Los Angeles USA	1961	Chlorine	1 died in the cloud of 27.5 tonnes released from a rail tank car	TOX
Kentucky, USA	1962	Ethylene oxide	Explosion equal to 18 tonnes of TNT, 1 killed and 9 injured	UVCE X
Buffalo, New York USA	1962	Propane	No record	UVCE
Louisiana, USA	1963	Ethylene	Fire of long duration	CVE
Texas, USA	1963	Propylene	£3M damage from a fire and explosion in a low pressure polypropylene polymerization unit	CVE
Texas, USA	1964	Ethylene	Fire and explosion from a release of gaseous ethylene (£1.5M)	FB CVE

(continued)

Table 2 (continuation)

Place	Date	Material Involved	Damage	Key
Massachusetts, USA	1964	VCM	Leaking sightglass ruptured on tightening under pressure. Escaping gas ignited and exploded. 7 killed, 40 injured (£2.5M)	CVE
Louisiana, USA	1965	Ethylene	12 injured following a fire and explosion of ethylene from a ruptured pipe (£1.5M)	CVE
Texas, USA	1965	Propylene	Pipeline failure in polypropylene polymerization plant caused £3M damage in an explosion and fire	FB CVE
Feyzin, France	1966	Propane	Frozen valve during sampling from storage sphere allowed a vapor cloud to form and explode killing 16, injuring 63	UVCE X
La Salle, Canada	1966	Styrene	11 died following an explosion after sight glass failure (£2M)	CVE X
West Germany	1966	Methane	3 killed, 83 injured	CVE
Santos, Brazil	1967	Coal gas	300 injured, 80 buildings of various sizes within a 2-km radius were either destroyed or damaged	CVE
Hawthorne, New Jersey, USA	1967		2 people killed, 16 injured. Explosion rocked buildings over a four block area	
Buenos Aires, Argentina	1967	Propane	100 people injured. Fire destroyed 400 surrounding houses	
Antwerp, Netherlands	1967	VCM	4 people killed and 33 injured. Fire burned for 3 days	
Lake Charles, Louisiana, USA	1967	Isobutane	7 people died when a leaking 10-inch gate valve liberated a cloud which exploded. Fires and secondary explosions continued for two weeks (£1M)	UVCE X
Bankstown, New South Wales	1967	Chlorine	Evacuation of large area of town. 5 people overcome by fumes	TOX
Perris, Netherlands	1968	Light hydrocarbons from stops tank	2 people killed, 75 injured. Blast shattered windows 1 mile away (£11M)	UVCE
East Germany	1968	VCM	24 people killed	
Paris, France	1968	Petrochemical plant	400 people evacuated. Explosion rocked houses in area	CVE
Hull, UK	1968	Acetic acid	2 people killed, 13 injured	CVE
Rjukan, Norway	1968	Gas	Shop and car windows broken	CVE
Soldatna, Alaska, USA	1968	LPG	2 seriously injured	

(continued)

Table 2 (continuation)

Place	Date	Material Involved	Damage	Key
Tarrytown, USA	1968	Propane	3500 people evacuated	
Lievin, France	1968	Ammonia	(AIChE 112, p 17)	TOX
Teesside, UK	1969	Cyclohexane	2 killed, 23 injured	FB
Libya	1969	LNG	12 people injured	
Puerto la Cruz	1969	Light hydrocarbons	5 people killed. Extensive glass and ceiling damage in the town	
Long Beach, California, USA	1969	Petroleum	Lid of 600-gal tank was blown into suburban area. 1 person killed and 83 injured	CVE
Escombreras	1969	Petroleum	4 killed, 3 injured. Shock waves broke windows for miles around, 5000 people evacuated	UVCE
Repesa, Spain	1969	LPG	An LPG leak ignited causing a refinery fire which burned for 6 days	FB
Crete, Nebraska USA	1969	Ammonia	6 died after 64 tonnes of ammonia were released from a rail tank car	TOX
Basle, Switzerland	1969	Nitro-liquid	3 people killed, 28 injured. Blast shattered windows hundreds of yards away	DET
South Philadelphia, USA	1970	Oil refinery	5 people killed, 27 injured. Blast	
Mitcham, Surrey, UK	1970	Propane/butane	Destruction to residential property nearby was widespread. Roofs were pierced, windows smashed, fences toppled and rooms burnt out. Two cars destroyed	CVE
St. Thomas Island	1970	Natural gas	Explosion rocked virtually the entire island. 25 injured	CVE
New Jersey, USA	1970	Oil refinery	40 people injured. Shock waves shattered windows over 60 sq mile area	UVCE
Port Hudson, Missouri, USA	1970	Propane	No fatalities, window breakage up to 18km	UVCE
Crescent City, Illinois, USA	1970	Propane	Derailment of rail tank car, business section of town destroyed	BLEVE
Emmerich, Germany	1971	—	4 people killed, 4 injured. Numerous buildings in area damaged	CVE
Holland	1971	Butadiene	8 people killed, 21 injured	
Arkansas, USA	1971	Ammonia	Livestock and fish killed. Scorched leaves in 10,000 acres of forest	TOX

(continued)

Table 2 (continuation)

Place	Date	Material Involved	Damage	Key
Holland	1972	Hydrogen	4 people killed, 4 injured	CVE
Brazil	1972	LPG	38 people killed, 75 injured. Shattered window panes in a 15km area	UVCE X
East St. Louis, USA	1972	Propylene	230 people injured, window pane damage up to 3km from rail tank car shunting accident	UVCE
West Virginia, USA	1972	Gas	21 people killed, 20 injured. Entire island sealed off	CVE FB
Japan	1973	VCM	1 killed, 16 injured	UVCE
Lodi, New Jersey, USA	1973	Methanol	Relieved vapors from a reactor exploded. Evacuation of hundreds of people within a radius of several 'blocks'. 7 died. (£1M damage)	UVCE X
Gladbeck, Ruhr, West Germany	1973	Cumol	1000 people evacuated	
Sheffield, UK	1973	Gas works	4 people died, 24 injured. Blast damaged buildings within a wide radius and blew in hundreds of windows. Cars were showered with debris and crushed by huge pieces of concrete	CVE
Saint-Acimand les Eaux, Nord France	1973	Propane	LPG truck overturned, 4 people killed, 2 missing. 37 injured	UVCE
Tokuyama, Japan	1973	Ethylene	1 killed, 4 injured (£12M)	UVCE
California, USA	1973	VCM	55 gallon steel drums of chemicals were hurled into the air and came down on houses, fields and the bay. Thousands of windows were smashed and at least 8 small houses badly damaged. The shock was felt 50 miles away	
Cologne, Germany	1973	VCM	Flange rupture released 10 tonnes VCM	UVCE
New York, USA	1973	LPG	40 people killed	UVCE X
Potchefstroom, South Africa	1973	Ammonia	38 tonnes released. Cloud (initially) 20m deep by 150m diameter) drifted to adjacent town. 18 people killed, 6 outside boundary fence, 65 injured	TOX
Falkirk, UK	1973	Flammable liquid	Destruction of tar distillery	FB
Texas, USA	1974	Isoprene	12 people injured. Shattered windows in wide area	UVCE

(continued)

Table 2 (continuation)

Place	Date	Material Involved	Damage	Key
Los Angeles, California, USA	1974	Organic peroxides	A leaking road tanker of organic peroxides exploded causing £25M damage	DET
Beaumont, Texas USA	1974	Isoprene	2 died and 10 people were injured after a vapor cloud explosion following a large spill of isoprene (£8M)	UVCE X
Czechoslovakia	1974	Ethylene	14 people killed, 79 injured	UVCE
Flixborough, UK	1974	Cyclohexane	28 people killed, 104 injured. 3000 people evacuated. River Trent closed to shipping, 100 homes damaged	UVCE X
Rotterdam, Netherlands	1974	Petrochemicals	Large fire	FB
Rumania	1974	Ethylene	1 killed, 50 injured	UVCE
Nebraska, USA	1974	Chlorine	500 people evacuated. Clouds of poisonous fumes spread over area	TOX
Florida, USA	1974	Propane	Destroyed 2 warehouses. Crushed cars and broke windows in a 4 block area	UVCE
Wenatchee, Washington, USA	1974	Monomethylamine nitrate	2 died, 66 injured in rail tank car explosion	DET
Holland	1975	Ethylene	4 people killed and 35 injured	UVCE
Marseilles, France	1975		1 killed, 3 injured. Blast shattered windows in large area around complex	CVE
South Africa	1975	Methane	7 people killed, 7 injured. All gas supplies cut off to city for two days	
Antwerp, Belgium	1975	Ethylene	Ethylene leakage from compressors exploded. 6 killed, 13 injured. Widespread structural damage to the plant	UVCE
Philadelphia, USA	1975	Crude oil	Vapors from a storage tank exploded in a boiler house when filling a marine tanker. 8 died, 2 injured (£5M)	CVE X
Holland	1975	Propylene	14 people killed, 104 injured	UVCE
Seveso, Italy	1976	TCDD	Complete evacuation from area up until present time (1978)	TOX
Beek, Netherlands	1976	Naphtha	14 died, 30 injured when a leakage ignited and blast shattered windows of shops and houses (£10M)	UVCE X
Baton Rouge, Louisiana, USA	1976	Chlorine	Mississippi closed 50 miles northward. 10,000 people evacuated	TOX

(continued)

Table 2 (continuation)

Place	Date	Material Involved	Damage	Key
Sandefjord, Norway	1976	'Flammable liquid'	Pipe rupture ignited, exploded, killing 6 people and causing £ 10M damage	FB CVE
Bracehead, UK	1977	Sodium chloride	Fire and explosion	DET
Mexico	1977	Ammonia	2 people died, 102 treated for poisoning. Gas entered sewer system	TOX
Umm Said, Qatar	1977	LPG	7 people died, many injured. Explosion scorched villages a mile away. Doha International Airport closed for 2 hours	FB
Mexico	1977	VCM	90 people injured	
Taiwan	1977	VCM	6 people killed, 10 injured	
Cassino, Italy	1977	Propane/butane	1 killed, 9 injured	CVE FB
Jacksonville	1977	LPG	2000 people evacuated	
Gela, Italy	1977	Ethylene oxide/ glycol	1 killed, 2 injured	CVE
India	1977	Hydrogen	20 people injured. Blast rocked nearby fertilizer plant, oil refinery and village	CVE
Italy	1977	Ethylene	3 people killed, 22 injured, shattered shop windows and doors. Car lifted several meters in air	UVCE
Colombia	1977	Ammonia	30 people killed and 22 injured. Nearby villagers suffered from effects of gas	TOX
Baltimore, USA	1978	Sulfur trioxide	Fumes drifted 10 miles away. More than 100 people treated for nausea	TOX
USA	1978	Grain dust	—	CVE
Waverly, Tennessee, USA	1978	Propane	12 dead and at least 50 injured when a derailed tank car exploded	BLEVE
Youngstown, Florida, USA	1978	Chlorine	8 people died and 50 were injured when gas escaped from a rail tanker involved in a crash	TOX

IV. Detonation Parameters of Vapor Explosions

Computed parameters for stoichiometric mixts of *gaseous* fuel/air detonations are presented in Table 3 (from Ref 12)

The last two columns in Table 3 are flammability limits. In general, detonability limits are narrower than flammability limits and vary somewhat with the mode of initiation. Note that

the detonation parameters for all the *stoichiometric* fuel/air mixts shown in Table 3 are quite similar. However, when one considers *non-stoichiometric* mixts, differences in detonation parameters do appear. This is illustrated in Fig 10 (Ref 12). Vertical lines in these graphs are flammability limits. Exptl measurements confirmed the validity of the above calcns as shown

Table 3
Calculated Detonation Properties

Fuel	Composition, ^a %	Temperature, ^b °K	Pressure, ^b Bars	Velocity, ^b m/s	LEL, ^c Volume %	UEL, ^c Volume %
Ammonia	21.8	2820	17.0	1880	15.0	28.0
Butadiene	3.67	3100	19.0	1840	2.0	12.0
Ethylene	6.53	3100	17.8	1840	2.7	36.0
Ethylene oxide	7.73	2950	18.4	1830	3.6	100.0
Methane	9.48	2780	16.3	1810	5.0	15.0
Propane	4.02	2820	17.5	1800	2.1	9.5
Vinyl chloride	12.2	2820	19.2	1810	3.6	33.0

a- Stoichiometric composition assuming H₂O, CO₂ products, percent by volume

b- Calculated temperature, pressure and velocity at the stoichiometric composition

c- Experimentally determined lower and upper flammability limits from "Flammability Characteristics of Combustible Gases and Vapors", by G. Zabetakis, Bureau of Mines Bulletin 627 (1965)

Table 4
Measured Detonation Properties

Fuel	Concentration, Volume %	Experimental		Calculated	
		Pressure, Bar	Velocity, M/s	Pressure, Bar	Velocity, M/s
Methane (90g booster)	5.0	5.4	950	11.2	1490
	6.0	5.6	950	12.6	1590
	7.0	6.5	1010	14.0	1675
	8.0	5.4	1030	15.2	1730
	9.0	7.0	1030	16.0	1780
	10.0	7.8	1050	16.5	1820
	11.0	7.1	950	16.6	1830
	12.0	6.6	910	16.4	1820
Propane (90g booster)	3.0	13.7	1710	15.2	1675
	3.6	15.2	1800	16.6	1750
Ethylene oxide (5g booster)	5.4	15.5	1770	15.5	1700
	9.7	17.0	1840	19.6	1880
	19.9	19.5	1810	19.9	1900

in Table 4, with the exception of methane/air which apparently is difficult to detonate

Based on theoretical considerations, Fuget (Ref 1) concludes that fuel/air mists with fuel droplets of less than 940 microns should behave as essentially homogeneous gas phase detonations. More recent computational studies by Gubin et al (Ref 14) indicate a much smaller droplet size (ca 10 microns) is necessary to attain

the same detonation velocity D as that of a homogeneous detonation. Their curves for D as a function of droplet diameter d_0 for stoichiometric kerosene/oxygen mixts is shown in Fig 11. Points 1, 2, 3 are exptl for droplet diameters of 190, 900, and 2600 microns, respectively

When stoichiometric kerosene/oxygen mixts are diluted with nitrogen, D decreases when the nitrogen level exceeds about 40%. This is shown

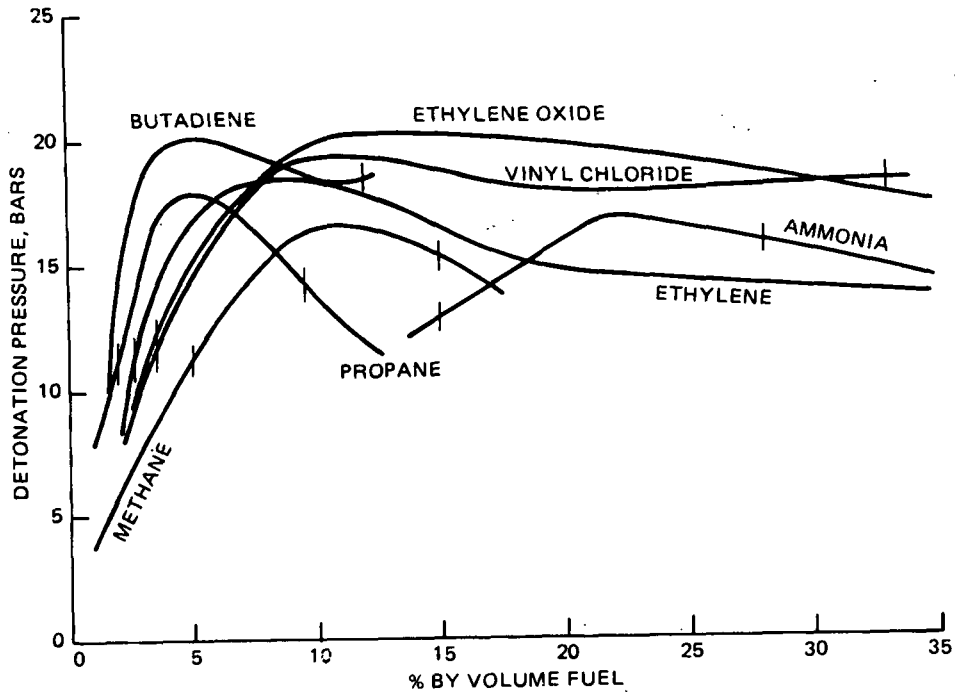

Fig 10 Calculated Detonation Pressure

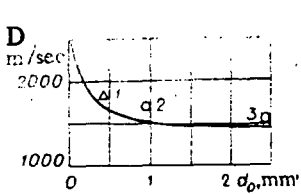

Fig 11

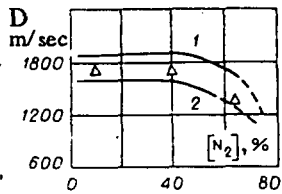

Fig 12

in Fig 12, where curve 1 is for $d_0 = 100$ microns, and curve 2 is $d_0 = 1000$ microns. The points shown are exptl. According to Gubin et al (Ref 14) the reaction zone in a stoichiometric mixt of 70/30 N_2/O_2 with 1000 micron kerosene droplets is 45mm, which is 20mm larger than the reaction zone in the corresponding oxygen/kerosene mixt

Theoretical models developed by Mitrofanov et al (Ref 18) also indicate that fuel droplet/oxygen detonations approach the steady CJ velocity of homogeneous gas detonations

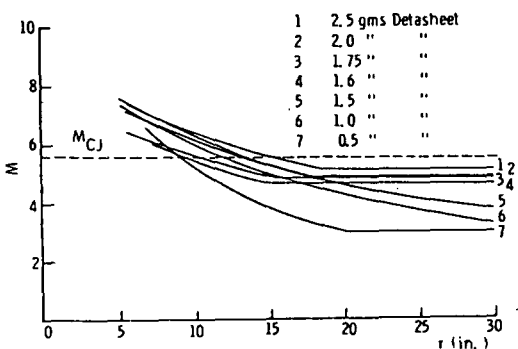

Fig 13 Experimental Mach Number—Radius Data—9.7% MAPP-Air

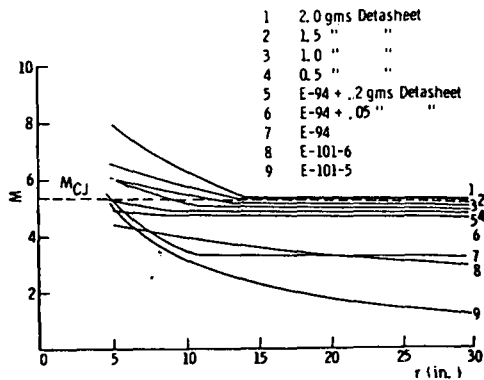

Fig 14 Experimental Mach Number—Radius Data—4% MAPP-Air

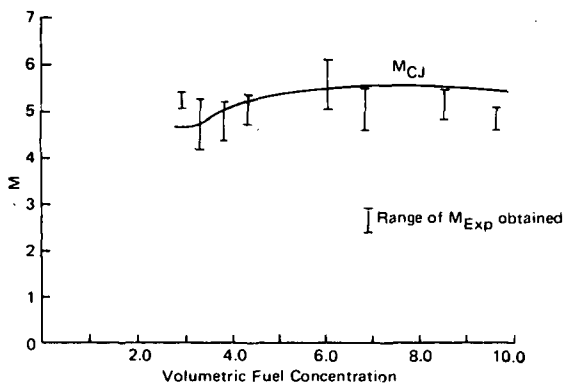

Fig 15 M_{Exp} and M_{CJ} as Functions of MAPP Concentrations

Fry & Nicholls (Ref 6) studied the expln of MAPP/air vapor clouds. MAPP is a mixt of 51/26/23% methylacetylene/propane/propadiene. Results of their expts in terms of Mach numbers for the propagation velocity are shown in Figs 13, 14 and 15. In Figs 13 and 14 initiation sources are indicated. Obviously, weak initiation results in low propagation velocity. The abscissa in Figs 13 and 14 is the distance (inches) from the initiation source. Fig 15 shows the mean values of the measured Mach numbers for detonations of various fuel/air compns. It also establishes the detonability range of these mixts of about 2.4 to 10 volume % of fuel. Inci-

dentally, their results (Table 5) show that detonation limit measurements are strongly influenced by the strength of the initiator used, and to a lesser extent by the apparatus in which the measurements are made

Vanta et al (Ref 2) determined the *detonation limits* of propylene oxide/air mixts to be 2.7 to 14.4 volume %, or much narrower than the *flammability* limits of ethylene oxide/air (see Table 3). They also measured the lower detonation limit for n-propyl nitrate/air and found it to be 2.2 volume %

Lu et al (Ref 16) used lab and field tests to examine the effects of additives on the detonability of fuel/air mixts. Fuel droplet size was also investigated. We quote: "The effect of the propyl nitrate and butyl nitrite on the detonability of a heptane drop-air mixture can be seen in the 1400 μ m drop mixture wave velocity history vs tube length shown in Figure 4. For comparison purposes, the blast wave velocity in an empty tube is also shown

The wave speed decays in both heptane, and heptane + 10% normal propyl nitrate (NPN) air mixtures, but more slowly when NPN is present. In all other cases the wave speeds all reach a steady state after a transition region, which indicates the establishment of selfsustained detonations

It is interesting to speculate on the cause of

Table 5
Detonation Limits of MAPP-Air Mixtures By Volume

Method	Initiator	Lower Limit	Upper Limit
Crawshaw-Jones apparatus	1g PETN	4.1	7.8
Crawshaw-Jones apparatus	10g PETN	2.4	13.7
Crawshaw-Jones apparatus	100g PETN	—	≥ 30
Bag test	800g C-4 (672g PETN equivalent)	2.9	10.2
Bag test	386g PETN	2.9	9.1
Sector chamber	2g Detasheet 'C' (1.57g PETN equivalent)	2.9	10.5 ^a

^a Extrapolated from test results taken up to 97% by volume

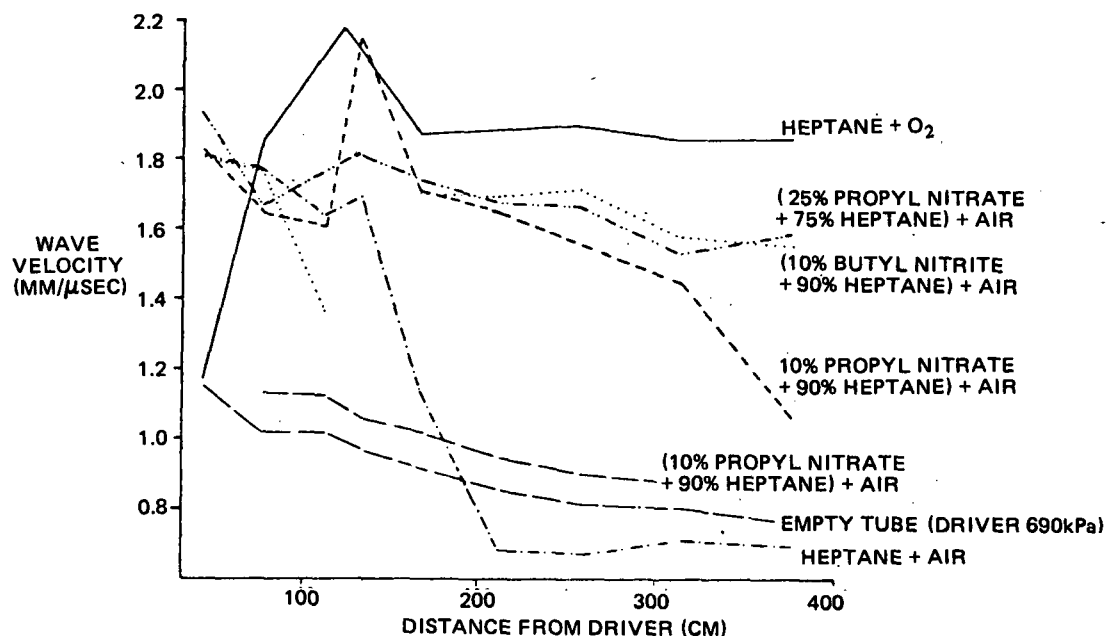

Fig 4 The Effect of Additives on the 1400 μ m Heptane Drop Mixtures Wave Velocities (from Ref 16)

Table 2
Effects of Additives and Drop Sizes on the Detonability of Heptane-Air Mixtures (from Ref 16)

Fuel	Drop Size		
	1400 μ m	700 μ m	Fog (\sim 10 μ m)
Heptane + 25% NPN	detonation	—	—
Heptane + 20% NPN	—	detonation	detonation
Heptane + 10% NPN	no detonation	detonation	detonation
Heptane	no detonation	no detonation	detonation "

the differences in detonability of the mixtures mentioned above. In the case of heptane-oxygen mixtures, it is obvious that the pure oxygen atmosphere is a significant factor in the detonability. It has been reported by Kauffman that the increase of oxidizer concentration by a factor of 3 will decrease the ignition delay time of shock ignited fuel drops by a factor of 4. It is believed that due to the short ignition delay time, the energy released by the burning fuel drops is better able to couple with and support the incident shock. In the cases of 90% heptane + 10% butyl nitrite and 75% heptane + 25%

NPN mixtures in air, the picture is less clear. One possibility is that only the reduction of ignition delay time caused by the addition of nitrite and nitrate improves the coupling between the shock front and combustion zone. In addition, it is also possible the nitrite and nitrate, through the formation of the RO, NO₂, and NO radicals, lead to new chain reaction paths which increase the overall rate of energy release from the burning drops. This would improve coupling between the shock wave and combustion zone to an even greater extent. One or both of these possibilities may be occurring

The effect of the fuel drop size on the detonability of heptane – additive – air mixtures can be seen in Table 2. Because of the high vapor-pressure of heptane and its additives, most fuel drops in the fog mixture probably vaporize prior to detonation

V. Mechanisms of Fuel/Air Explosions

The desirability of producing a viable *single-stage FAE III* (to be described in the next section) has provided the impetus for a considerable effort at elucidating the mechanisms involved in the expln of fuel/air mixts. In spite of these efforts, there is still no clearly defined scheme of the steps involved and there is still controversy amongst investigators as to the importance of the various steps proposed.

A mechanism for fuel/air detonations which has gained appreciable support (Refs 5, 16 & 18) is as follows:

Inside the reaction zone there occur:

- 1) Deformation and acceleration of fuel droplets
- 2) Breakup of droplets at the instant that a critical deformation stage has been attained
- 3) Boundary layer stripping and possible evaporation of the fuel.
- 4) Ignition of the micro-mist thus formed
- 5) Energy transfer from these localized ignitions to the shock front

There is disagreement about the mode of energy transfer in step 5 above. Gubin et al (Ref 14) postulate that the detonation velocity of a fuel/air mixt is determined by the amount of liquid that has broken away from the original fuel droplet at the time of mixt ignition. Consequently, according to this model and in accord with observation, D is independent of the amount of liquid fuel in the system. When the mixt is depleted of liquid, the detonation velocity begins to fall because of the accumulation in the reaction zone of a considerable amount of gaseous oxidizing agent that is not participating in the reaction. This also increases the discrete distribution of the energy sources and the associated energy losses in the emission of compression waves in the detonation products. Analogous variation in the detonation velocity is observed for constant fuel/air ratios when the mixt is diluted with inert gas (see Fig 12)

An additional stabilizing effect is claimed (Ref 14) to arise from retardation of gas flow and consequent increase in temp for high fuel concns in the reaction zone. The temp rise is accompanied by a reduction in the ignition lag, which leads, in turn, to a decrease in the mass of fuel igniting at time t_1 and conversely. Reduction in liquid concn leads to a smaller temp rise in the reaction zone and hence to an increase in ignition lag. Increase in the lag means increase in the degree of drop breakdown at ignition. Therefore, over a certain range of concns in the kerosene-oxygen-nitrogen mixt, the amount of fuel that accumulates prior to ignition is found to be practically constant, which means that the detonation velocity is also constant. When the mixt is diluted with more than 40% nitrogen, the decrease in the degree of drop breakdown before ignition and the detonation rate decreases (see Fig 12)

Gubin et al (Ref 14) claim that from their model it is possible to determine the effect of the mixt compn (or of dilution of the mixt with inert gas) on the velocity of two-phase detonations. Thus the detonation velocity is determined mainly by the amount of liquid that has broken away from the drop at time t_1 . Therefore, over a broad range of initial concn, the velocity of the two-phase detonation is independent of the amount of liquid in the system. Curves 1, 2 and 3 in Fig 16 are for $d_0 = 290, 900$ and 2600 microns. Curve 4 is for vapor (no liquid). The abscissa α indicates the ratio of oxygen to fuel. Thus a $\alpha = 1$ is the stoichiometric mixt, $\alpha > 1$ is oxygen rich, and $\alpha < 1$ is fuel rich. At $\alpha < 0.5$, D decreases with a further decrease in α . According to Gubin et al, this is primarily due to interactions between neighboring fuel droplets

In summary, Gubin et al state: "Thus, on the basis of a model of a detonation wave in which the position of the Chapman-Jouguet plane coincides with the region of ignition of the cloud of secondary particles after breakdown, it is

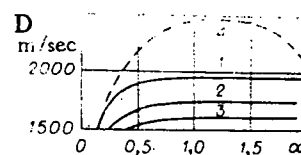

Fig 16 (from Ref 14)

possible to describe several important properties of heterogeneous detonation associated with variation in the drop size and the dilution of the mixture with an inert gas. The model gives an understanding of the causes of the greater stability of two-phase detonation in comparison with gaseous detonation in the region where the combustion of the fuel is very incomplete. Any decrease in the detonation velocity is associated with an increase in the ignition lag, which leads to an increase in the amount of mixture ready for combustion behind the wave front. This means that the leading edge of the wave front is accelerated as a result of the increase in the amount of fuel involved in the reaction."

In theoretical and exptl studies of shock-loaded fuel drops, Slagg et al (Ref 5) emphasized the importance of the chemistry of the fuel. For example, for incident shocks of Mach 3.3 on a drop of fuel in a purely oxygen atm, only ethyl or propyl nitrate ignited and expld. Under the same condition, no ignitions were obtained with nitromethane, 1- or 2-nitropropane, nitrobenzene, butyl alcohol, heptane and decane. Slagg et al point out that the RO-NO₂ bond in the nitrate esters is much weaker than R-NO₂, R-H, R-OH, and ϕ -NO₂ bonds of the species that did not ignite. Furthermore, their observations showed that drop shattering is not necessary for ignition of ethyl or propyl nitrate drops. Ignition occurs in the boundary layer within ca 7 microseconds after shocking. A schematic representation of fuel drop breakup is shown in Fig 17

Later studies by the above authors (Ref 16) demonstrated that the detonability of heptane/air mixts is greatly enhanced by the addition of about 20% of n-propylnitrate or n-propylnitrite. This further emphasizes that the chemistry of the fuel (or more properly fuel/additive) mixts

cannot be ignored in considerations of the mechanism of fuel/air explns. Another important observation of this study was that Schlieren photographs showed no evidence of blast waves in the wake of shocked single drops of fuel or in the reaction zone of propagating fuel/air detonations. This contradicts the hypothesis that had appeared in the literature that such blast waves are necessary to maintain fuel/air detonations

Lee and coworkers (Refs 11, 13 & 20) have applied a new name and some fairly extravagant claims to a concept that is at least 30 years old. Their SWACER mechanism (Shock Wave Amplification by Coherent Energy Release) which they claim to be operative in the initiation and propagation of fuel/air explns, appears to be an adaptation of a DDT mechanism proposed by Kistiakowsky in the late 40's. Since then, similar considerations have been applied to shock initiation processes in heterogeneous solid expls (see article on *Shock Sensitivity of Explosives* in Vol 9, S 58-R to S83-R). In particular, shock amplification by coalescing microshocks, critical run-up distances and more rapid reactions at sites that have received earlier or stronger external stimulation (shock, radiant energy, etc) are all concepts that have repeatedly appeared in the expl literature prior to the enunciation of the SWACER mechanism. Thus, though Lee and coworkers have made valuable contributions to the understanding of free radical involvement in fuel/air explns, their claims for the discovery of a "universal initiation mechanism" are unjustified. In their studies external flash sources were used to initiate detonation (eg, in a mixt of H₂ and Cl₂) photochemically. The primary step in such initiation is the production of free radicals. Subsequently, as quoted from Ref 13: "Due to the exponential decay of free radical concentration away from the window of incident UV radiation, the layer of gas immediately next to the window has the shortest induction delay and explodes first. The shock wave generated then propagates into the next layer of gas which is first on the verge of exploding, since its induction delay is slightly longer than the layer next to the window. The shock then triggers the explosion and the resultant energy release enhances the shock and it becomes stronger as it advances to the next layer. This layer again is on the verge of exploding and the shock now

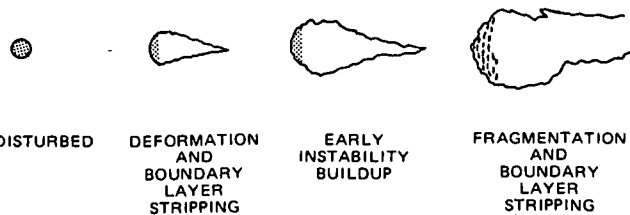

Fig 17 Phenomena Associated With Breakup of Fuel Drops in a Two Phase Detonation (from Ref 5)

triggers it and the subsequent energy release further enhances the shock. In this manner, the concentration gradient provides the means whereby energy can be released in phase with the shock. This coherent energy release gives rise to a very rapid amplification of the shock leading to the formation of detonation. This amplification of the shock wave by coherent energy release is analogous to the principle of a laser where stimulated emission triggered by the light wave provides coherent energy release to the light wave and gives rise to its amplification. Thus we may refer to the mechanism of photochemical initiation as the SWACER mechanism representing "Shock Wave Amplification by Coherent Energy Release" in analogy to LASER

which denotes "Light Amplification by Stimulated Emission of Radiation."

Lee and coworkers distinguish between subcritical, critical and supercritical external flash intensities to produce photochemical reaction. For *subcritical* intensities, free radical production is too low to produce the sequence of events described above. *Critical* intensities do create these events. At very high, *supercritical* flash intensities, free radical production thruout the gas volume is so large and subsequent reactions are so rapid that the entire gas volume *explodes* in what amounts to a constant volume expln

Urtiew et al (Ref 7) studied the reaction between silane (SiH_4) and tetrafluorohydrazine (N_2F_4) with cis-2-butane as an inhibitor. The

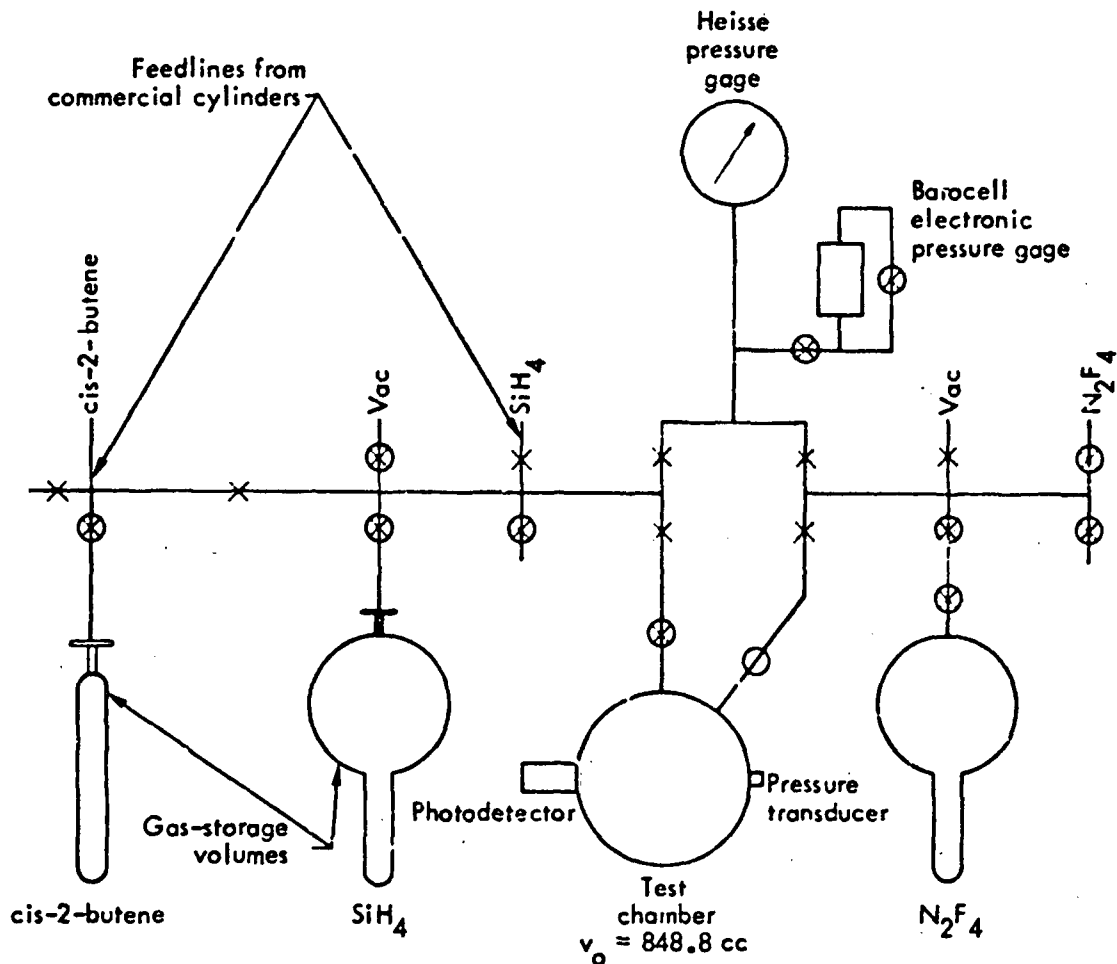
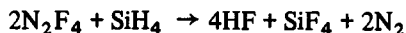

Fig 18 Experimental Setup in a Vacuum System for Testing the Delayed Ignition of Spontaneously Ignitable gases (from Ref 7)

reaction was carried on at room temp in an evacuated stainless steel chamber with photo-detector and pressure transducer monitoring (see Fig 18)

The reaction proceeds via F radicals and its net result can be represented as



The net inhibition reaction is:

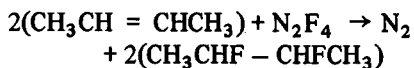

Depending on the amount of inhibitor used, initiation of detonation could be delayed for as long as 30 to 45 minutes! As pointed out by Wilson (Ref 26) such long delays are quite inconsistent with the so-called SWACER mechanism

Von Elbe and Hale (Refs 29 & 30) showed that very rapid dispersal of interhalogen compds (eg, ClF_3 or BrF_3), acting as free radical sources, into hydrocarbon/oxygen mixts can produce detonation. Tests were made with Diesel fuel or heptane in oxygen, air or nitrogen mixts. For the oxygen mixts, detonations or near-detonations were obtained. For air, the reaction was less violent but appreciable overpressures were generated. In nitrogen there was no reaction. It was found that the strength of the fuel/air blast thus initiated depends primarily on the effectiveness and rate of free radical source dispersement thruout the vapor cloud. All these observations are not in accord with the claimed "universality" of the SWACER mechanism. A broad-brush reaction mechanism based on competition of chain branching and chain breaking is presented

An interesting analysis by Gerstein (Ref 19) suggests the wide applicability of controlled mixing of a variety of highly reactive components to produce fuel/air explns. We quote: "When a spontaneously flammable fuel is added to air, the resulting fuel-air mixture exhibits lean and rich flammability limits for spontaneous ignition in exactly the same manner that a normal fuel-air mixture does for spark or hot surface ignition. The addition of non-spontaneously flammable substances, such as hydrocarbons, acts as a diluent (changing the limits) just as an inert changes the flammability limits of a conventional fuel-air mixture

Through the use of liquids of different volatility (e.g. trimethyl aluminum and decane) and varying liquid compositions, the time to ignition can be controlled or programmed. The effect is shown in Fig 19 where the partial pressure of trimethyl aluminum (TMA) is shown as P_A and of decane as P_B . Concentrations of TMA in decane from 1% to 50% are shown. Raoult's law was assumed to apply to the vapor pressure for the evaporation calculation. When the solid curve crosses the dashed curve (flammable envelope), ignition occurs. The numbers near the circles represent time in seconds. At the time when the composition corresponding to the intersection of the two curves occurs, a homogeneous ignition should occur throughout the spray cloud. Some edge effects are to be expected at the periphery of the cloud."

Some preliminary studies of FAE clouds were made by de Longueville (Ref 20) using propylene oxide fuel dispersed in air by the detonation of an HE charge. Observations were made with a moderate speed framing camera. He noted a first phase showing a very fast expansion of the liquid propylene oxide contained in the canister, essentially characterized by a Gurney-type energy transfer (see article on "Velocity of Fragments" in this Vol), and a following phase occurring a few tenths of a millisecond after the bursting charge detonation, and consisting of a slow evolution of the cloud dimensions which can be defined by the average values of height and diameter as functions of time

Falling speed of the canister hardly affects cloud dimensions, but the mass ratio of HE/fuel, canister volume and ambient temp control cloud dimensions

A more detailed study of fuel cloud dispersion, though one lacking direct exptl verification, was made by Rosenblatt et al (Ref 23). The purpose of their study was to develop and use physically based numerical simulation models to examine the cloud dispersion and cloud detonation with fuel mass densities and particle size distributions as well as the induced air pressures and velocities as the principal parameters of interest. A finite difference 2-D Eulerian code was used. We quote: "The basic numerical code used for the FAE analysis was DICE, a 2-D implicit Eulerian finite difference technique which treats fluid-particle mixtures. DICE treats par-

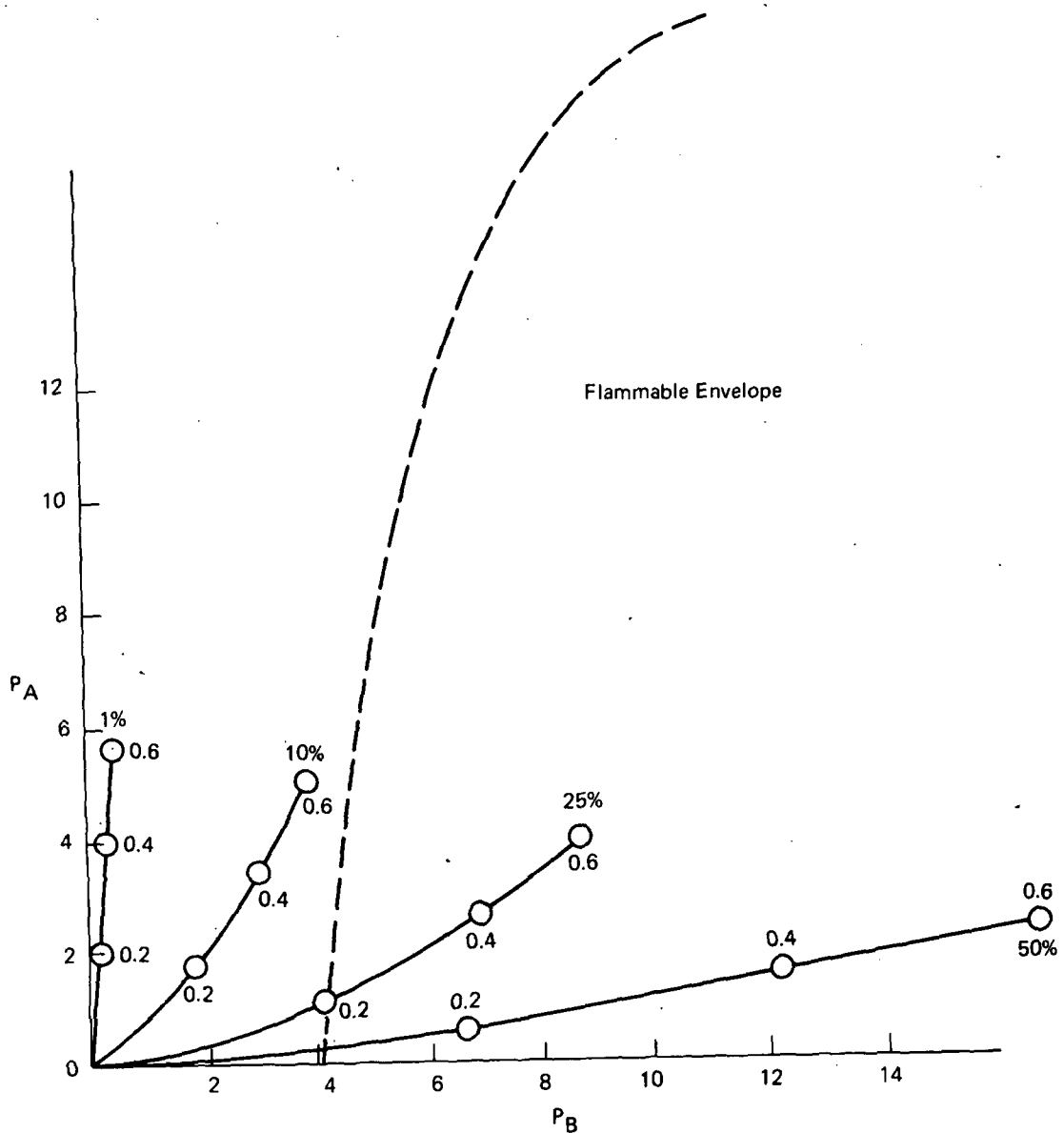

Fig 19 Ignition Curves for TMA-Decane Mixtures (from Ref 19)

ticle size groups which can flow independently through the Eulerian grid. Mutual momentum and thermal interactions between the particles and the gases are treated through drag and heat exchange models. Phase changes (solid-liquid-vapor) can take place

For application to FAE analyses, adaptations were made in the basic DICE code to allow treatment of, (1) stripping or breakup of liquid drops into smaller droplets as they are acted on by aerodynamic forces, and (2) burning of the fuel, with development of a detonation wave if the

local energy release rate is sufficiently high

Using the DICE-FAE code, solutions were generated of both the fuel cloud dispersal and detonation phases for an FAE device, the BLU-73. The cloud dispersal analysis started with initial conditions representing the fuel mass and burster products just after canister breakup, and followed the subsequent cloud dispersal until 60 msec

The cloud detonation analysis started with the cloud characteristics at 60 msec and with second event initiation by a centrally-located

explosive charge at that time. This analysis extended through cloud detonation and to 77 msec."

The principal conclusions of their study are:

(a) The flow field within the expanding fuel cloud leads to severe variations in the fuel density. Rapid radial expansion of the fuel mass near the meridian plane of the device causes vortices to form above and below this plane.

Fuel within the vortices cannot escape because of circular flow. Consequently, these are regions of high fuel concn. Fuel between the vortices is swept to larger radii by the rapid flow. This causes an accumulation of fuel at the larger radii, forming a third region of high fuel concn. Large fuel (vapor and liquid particles) gradients persist to the end of the dispersal phase

(b) Cloud dimensions predicted by DICE-FAE at the end of the fuel dispersal phase compare favorably with exptl observations

(c) Fuel drop breakup by aerodynamic shattering is effective in reducing all but the very largest fuel drops to small droplets. By 10msec, all fuel drops with initial diameters smaller than 1 cm have been completely shattered into 0-0.2cm droplets (0.01cm mean particle size). At the time of the second event initiation (60-msec), 90% of the fuel mass in the cloud consists of 0-0.2cm droplets. About 3 lbs of the fuel has impacted the ground

(d) A relatively large, centrally-located second event initiator charge is required to detonate the cloud, since fuel concns near the axis are relatively low at 60msec. A 70gm initiator proved inadequate, and the detonation would not propagate thru the cloud. A 350gm initiator was then used, and the cloud was successfully detonated in the numerical simulation

(e) During cloud detonation, fuel droplets are first vaporized as the detonation shock arrives; detonation then occurs until the locally available fuel or oxygen is exhausted. After 60msecs there is rapid vaporization of fuel droplets during the period from 60 to 63msecs. The detonation is complete by about 67msecs

(f) The maximum pressure experienced on the ground during the FAE detonation was 200psi at about 10-ft radius; impulse delivered to the ground was a maximum at the axis and dropped sharply with increasing radius

Dabora (Ref 21) investigated the behavior of

single fuel drops in quiescent air or oxygen, when activated by a Ruby Laser beam. We quote: "In each experiment a drop (1.5mm) hanging from a wire is subjected to a ruby laser beam. The laser can be operated in either the Q-switched mode or the pulsed mode and in most of the experiments the original laser beam is split in two beams which are focused from opposite directions on the droplet. The resulting phenomenon is observed interferometrically and monitored by a pressure transducer placed at 5cm below the droplet

It was found that when the laser is operated in the Q-switched mode, the droplet (Propyl-nitrate or heptane) appears to break up or evaporate without ignition; however, a blast wave due to energy addition via gaseous break down is always present. When the laser is operated in the pulsed mode with two pulses at 100 μ sec apart, the first pulse serves to break up the drop and the second to ignite it. In this case explosive combustion is often observed in oxygen whereas a non-explosive ignition takes place if air is used."

Meister (Ref 17) stated: "A reflected shock tube technique has been used to measure the ignition delay time for propylene oxide-oxygen-nitrogen mixtures in the temperature range of 900 to 1250°K. Mixture equivalence ratios * ranging from $\phi = 0.8$ to $\phi = 1.25$ were used. Ignition delay times were measured by using both streak schlieren and pressure gauges mounted on the back wall of the shock tube. A regression analysis indicated that the delay time multiplied by the propylene oxide concentration to the 0.8 power and the oxygen concentration to the -1.2 power yielded a best fit when plotted as a logarithm against the reciprocal temperature. This regression analysis also indicated that the nitrogen concentration had no effect on the ignition delay time. The apparent activation energy for the reaction was found to be approximately 19kcal or 1.6×10^6 joule/mole."

No explanation is offered for the peculiar fractional power dependence of the ignition delay times on fuel or oxygen concn. Nor is there any comment on what appears to be a low

* A mixt equivalent ratio of 1 is a stoichiometric mixt, a ratio less than one is an oxygen-rich mixt, and a ratio greater than one is a fuel-rich mixt

activation energy. In general, results of kinetic studies in shock tubes are difficult to interpret. Incidentally, Meister determined that presence of nitrogen did not affect ignition delay. Most of the ignitions he observed he classified as "mild" ignitions

VI. Military Applications of Fuel/Air Explosions

The impetus for military interest in fuel/air explosions has been addressed in Sections I and III of this article, as well as the article on "FAE and FAX" in Vol 6, F3-L to F4-R

Liquid FAE (Fuel-Air-Explosive) devices are weapons which disperse a liquid fuel to form a relatively extensive cloud by using a small expl charge. After the cloud has expanded enough to provide a suitable fuel/air mixt ratio, it is detonated. The fuel is initially contained in a canister with the dispersing expl (burster charge) at the center. The detonation of the cloud (usually referred to as the second event, or SE) is initiated by one or more small expl charges injected into the cloud. Ideally, the dispersed fuel should be totally consumed in the FAE detonation. Fuel-rich areas (in which some of the fuel doesn't burn because the oxygen is exhausted) or fuel-lean areas (with low fuel/air ratios) within the cloud should be avoided

FAE is *presently* a two-step process: an expl burster disperses the fuel into a suitable fuel/air cloud, then a second-event expl, activated within an easily-detonable region of the cloud, initiates detonation of the entire fuel/air cloud. A single-event FAE can be produced by the simultaneous dispersal and detonation of the fuel/air cloud as it is being formed. Alternatively, a spontaneous FAE can be achieved by dispersing a pyrophoric fuel into an appropriate fuel/air cloud within the ignition induction period. Such a single-event system has decided advantages over the two-event FAE

Tullis (Ref 26) investigated both of these approaches to a single event FAE and proposed: "a concept best described as a one-step automatic two-event FAE. Here the second-event explosive is replaced by a very highly hypergolic oxidizer under the implosive dispersal mode. The technique is a one-step process since only one explosive charge need be detonated. The mechanism, however, proceeds via two events as the explosive charge causes a dual dispersal:

(1) the fuel is dispersed into a fuel-air cloud immediately and (2) the hypergolic oxidizer is dispersed somewhat later, after the implosion compression is relieved. It must be noted that for a true FAE to occur the fuel must be dispersed appropriately in air. This requires a small but finite amount of time. Whether the subsequent fuel-air detonation is achieved spontaneously, as in the case of pyrophoric fuels, or automatically, utilizing this implosion mechanism, a second event is nevertheless necessary. Automatic detonation requires only a small amount of hypergolic oxidizer, just enough to initiate the detonation of the fuel-air cloud." To date, exptl verification of this concept has not been achieved

A detailed description of the presently available FAE-II system is given by Robinson (Ref 4). We quote the abstract of his report: "Fuel air explosive (FAE) weapon systems require the formation of an aerosol cloud in the air above a target point and the subsequent detonation of this cloud. To maximize the explosive capacity of this cloud, the amount of fuel allowed to impact the ground must be minimized. Therefore, the fuel must be dispensed (forcibly) at some distance above the ground. The plan adopted for FAE development consisted of (1) the practicability of forming the aerosol cloud, with the fuel container static and in motion toward the ground, (2) the successful detonation of the resulting cloud, and (3) the formation of the aerosol cloud, above ground from a flight qualified store. The demonstrations were accomplished as follows: (1) static and dynamic cloud formation by means of a 2000 lbm FAE test body; (2) cloud detonation for the case of the munition in motion by means of a trailing tethered detonator package and a rearward firing mortar system; and (3) the provision of above ground fuel dispersion from a container in motion."

Further modification of the FAE-II bomb is presented by Miller (Ref 3). This report describes an aerodynamic decelerator as follows: "Applying a Ram Air Inflatable Decelerator (RAID) as the aerodynamic decelerator system to meet the air-delivery requirements for the 2000-lb fuel air explosive (FAE) bomb. The delivery approach considered is to allow the bomb to free-fall in an unretarded configuration until it reaches the vicinity of the target. At this

point the RAID is deployed, resulting in the bomb assuming the near-vertical flight path and the relatively-low velocity desired at ground impact. The delivery approach reduces wind effects and other flight factors which degrade bombing accuracy. It also lends itself to the incorporation of a guidance capability into the weapon. The ability of the RAID to structurally survive deployment in a high-dynamic-pressure environment and its insensitivity to Mach-number effects result in a superior performance for this application than could be provided by a conventional parachute. A nominal RAID configuration, including size, fabrication technique, materials, and attachment method, is presented. Trajectory performance, inflation characteristics, flight stability, and packaging.”

In addition to an airborne destructive device, the FAE system has been examined for use as a nuclear blast simulator. Messina & Summerfield (Ref 24) suggest the use of large balloons filled with an appropriate fuel/oxygen mixt. They describe this fuel/oxygen expl (FOE) as follows: “The need for a non-nuclear explosive source that can simulate quantitatively the blast overpressure and impulse of a nuclear weapon at a distance when it is detonated at the surface of the earth is important to those charged with designing defensive military structures, military vehicles, military weapons, etc. Various concepts for such a non-nuclear source have been considered in the past. In this paper, a concept is presented that has some striking advantages. The foremost advantage is that it requires no uncertain basic research; it makes use of known explosion characteristics and requires only straight-forward engineering. The second important advantage is that it is the least costly of the various alternatives examined by us, not only in the final full-size system but also in the initial developmental steps that may be needed, from first trial to the final system

Although the first inclination of the designer might be to scale up the design concept of an existing FAE weapon, that is, to make use of a similar monopropellant fuel (generally liquid), a similar expulsion and dispersion system, and perhaps even a similar type of fuel containment, it becomes evident upon reconsideration that the weapon-configured FAE is *not* the simplest way to do the job, that the complexities of that type

of system can be avoided when there is no need to *launch* the device. This leads almost directly to a simple balloon-contained oblate-hemispherical body of premixed gas, which for simplicity and cheapness is chosen to be natural gas and oxygen in exact stoichiometric proportions. The exactness of mixture ratio and cloud shape lead to precise control of the resulting blast signature

Balloons of the size needed to contain a 1-kton fuel-oxygen explosive source (FOE) are commercially available in today's market. (In fact, present large balloons, designed as warehouses, athletic stadiums, etc., are much too rugged for our purpose of one-time use, and yet they are cheap enough for the system.)”

Sedgewick & Pierce (Ref 26a) are developing a one-kiloton FAE simulator. They envision the formation of point-source initiated hemispherical FAE clouds by multiple nozzle fuel injection. They estimate that with propylene oxide fuel the minimum cloud diameter should be 142m

Yet another military application involves delivery of fuel to form a FAE by a flame thrower tank. This concept was examined by Kingery and Sullivan (Ref 22) whose report abstract we quote: “A large building was recently destroyed in a feasibility demonstration at the BRL using a spray-generated fuel-air explosion delivered by a flame thrower tank. The technical approach had been validated before by the Air Force Armament Laboratory. Behind such a test is Army concern that as countrysides become more developed, any future conflicts will unavoidably spill over into builtup areas. Tanks are presently relatively ineffective in cities since available Army rounds have not been optimized to attack buildings. The results of the firing test described here raises the possibility of increasing tank lethality in cities by equipping special tanks with a spray generating fuel-air device

The cloud of fuel was sprayed from a modified unmanned flame thrower tank. In four seconds the nozzle dispersed 100 pounds of propylene oxide into a cloud 100 feet long, 10 feet high, standing a foot off the front of the building. Three hundred milliseconds after spray cutoff, the explosion was initiated by firing two each, one pound high explosive charges pre-emplaced to be inside the cloud. The building's

dimensions were 40 x 20 x 16 feet, wooden framework covered by asbestos board. The fuel-air explosion left no identifiable framing members except for the floor joists. Good blast records were obtained which indicate the loading on the building and the environment inside the tank itself.

The measurements show that a tank crew would not have been hurt if hearing protectors were used. The test results indicate that a massive overkill of the structure took place, indicating the desired effect could be produced with less fuel sprayed."

VII. Accidental Fuel/Air Explosions

Lewis (Ref 25) examined conditions under which FAE accidents might occur. His conclusions are:

- No sizeable accidental FAE's have been discovered as having occurred during high wind conditions. A highly turbulent atm appears to disperse the fuel without giving it effective contact time with potential ignition sources

- Where the accidental fuel release is the result of an internal combustion or other reaction, the released fuel is at an elevated temp and contains a concn of free radicals derived from the internal reaction such that the ignition delay is short. (Also, the ignition can be characterized as multipoint where the blast effects approach that of a bursting pressurized sphere)

- Fuels can be divided into four categories according to their combustion character. The autodecomposable fuel category (acetylene, etc) is followed by a category typified by ethylene where the damage record is significantly more severe than the normal fuel category. Lastly, there is a sub-normal fuel category containing pure methane, ammonia, methylene chloride, etc, for which no expl behavioral incidents have been found (sic)

- Most important are the mechanisms of release, the release position relative to the surroundings, and atm conditions. These determine how the fuel mixes with air and its movement in the atm once a fuel/air cloud is formed. The conditions under which the fuel had been contained and its pressure-temp characteristics frequently determine if the cloud is predominantly a mist and whether it is dense or light compared to the atm

- There is the influence of potential ignition sources. These are minimal in non-built-up areas and differ in nature between industrial and residential areas. The result is that cloud drift tends to be larger in the more open areas, but that the larger time delay before ignition decreases the turbulence level in the cloud

Davenport (Ref 10) states: "Vapor cloud explosions have in recent years been the predominant cause of the largest losses in the chemical and petrochemical industry. Because of trends toward plants of larger capacity, higher pressures, higher temperatures and greater inventory holdup, these losses have been increasing both in frequency and severity"

He then goes on to outline methods to be developed to reduce these losses. These are primarily along the lines of data collection and data analysis. Apparently insurance companies have assessed the potential loss in chemical and petrochemical plants as follows (Ref 10): "For a number of years Industrial Risk Insurers has been using a calculation method to estimate the potential for probable loss in plants where a vapor cloud hazard exists that uses the following criteria:

1. The maximum credible spill is equal to the contents of the largest process vessel or train of vessels not readily isolated. Storage vessels and major supply or fuel pipelines are not considered.

2. The amount of material vaporized for hot flashing liquids is equal to a ratio of the superheat of the material ($C_p \Delta T$) to the heat of vaporization (ΔH_v). Materials with a boiling point below 70°F are assumed to vaporize 100%

3. The explosive yield is equal to 2% of the theoretical heat of combustion potential in the cloud and is expressed as an equivalent quantity of TNT using a heat of combustion of 2,000 B.t.u./lb. for TNT

4. A maximum peak overpressure from the explosion is 5 lb./sq. in."

Based on these criteria, estimated potential losses by product are shown in Table 6 (Ref 10)

Actual accidents are listed in Table 7 (Ref 10). According to Davenport, the data in Table 7 are in reasonable accord with the predicted data in Table 6

Table 6
Estimated Losses Using Industrial Risk Insurers' Calculation Method

<u>Material Spilled</u>	ΔH_c <u>B.t.u./lb</u>	<u>Weight of Material Spilled, lb</u>	<u>Total B.t.u.'s</u>	<u>Property Damage Loss Estimated \$ millions</u>
Propylene & Propane	19,750	342,000	6.8×10^9	29.6
Benzene	17,446	322,000	5.6×10^9	11.2
Ethylene Oxide	12,024	56,000	6.7×10^8	8.0
Propylene	19,683	46,000	9.1×10^8	17.0
Ethylene	20,276	66,000	1.3×10^9	33.2
Propylene	19,683	66,000	1.3×10^9	47.8
C ₄	19,484	39,000	7.6×10^8	15.2
Butadiene	20,200	42,000	8.5×10^8	13.5
Butadiene	20,200	10,400	2.1×10^8	5.0
Vinyl Chloride	8,239	9,000	7.4×10^7	8.5
Ethyl Chloride	8,822	180,000	1.6×10^9	13.8
Ethylene Oxide	12,024	70,000	8.4×10^8	16.4
Cyclo-hexane	18,846	26,000	4.9×10^8	11.8
Vinyl Chloride	8,239	24,000	2.0×10^8	12.3
Vinyl Chloride	8,239	61,000	5.0×10^8	12.0
Vinyl Chloride	8,239	26,000	2.1×10^8	9.8
Monochlorobenzene	11,754	4,000	4.7×10^7	9.0

Lind & Whitson (Ref 12) examined the expln hazards associated with spills of large quantities of flammable materials. Some of their results were discussed in Section IV of this article. Their additional findings (not all of them novel) were:

- Damaging pressure pulses can be produced by deflagrations (without DDT) but damage area is restricted to approximately the area of the vapor cloud
- Methane/air detonations are most difficult to initiate with HE boosters
- Under very light confinement in hemispherical geometry only deflagrations were observed when the fuels (see Table 3) were mixed with air and initiated by high-energy sparks. Flame propagation velocity was increased by turbulence

Their final conclusions were: "The unconfined burning characteristics have been investigated for premixed fuel-air mixtures using methane,

propane, ethylene, butadiene, ethylene oxide and acetylene fuels. Although attempts were made to optimize conditions for transition from burning to detonation in unconfined mixtures, no transition occurred. Flame accelerations did occur; however, the flames appeared to reach a constant velocity after an initial acceleration, and accelerations which would be expected to lead to a transition to detonation in larger clouds were not observed

A sustained detonation in unconfined methane-air mixtures is not produced with solid explosive boosters of up to 2kg. This implies that, if a detonation occurred in a confined space due to confinement, the exit of the detonation wave from the confinement would have to be through an opening over 2.3 meters in diameter, or the detonation would not be sustained. How much larger the opening would have to be was not determined."

Table 7
Selected Industrial Incidents

Year	Material	ΔH_c B.t.u./lb.	Weight of Material in Cloud, lbs.	Total B.t.u.'s	Actual Loss, \$ million	Corrected Loss to 1976 \$ million
1954	Acrolein	11,830	40,000	4.73×10^8	2	5.4
1961	Cyclohexane	18,676	8,500	1.59×10^8	0.7	1.47
1962	Ethylene Oxide	11,482	38,000	4.36×10^8	8	16.56
1964	Ethylene	20,276	200 to 500	4×10^6 to 1×10^7	3.2	6.5
1965	Ethyl Chloride	8,246	38,000	3.13×10^8	0.9	1.8
1966	Methane	21,502	600	1.2×10^7	4.8	9.4
1966	Butadiene	19,200	850	1.6×10^7	0.016	0.03
1967	Isobutylene	19,367	20,000	3.87×10^8	17.5	32.7
1968	$\leq C_9$	19,000	100,000 to 200,000	1.9×10^9 to 3.8×10^9	28	50
1969	Naphtha + H ₂	19,000	50,000	9.5×10^8	3.5	6
1970	$>C_{10} + H_2$	19,000	250,000	4.75×10^9	30	48
1971	Ethylene	20,276	8,000	1.62×10^8	2.6	3.9
1971	Ethylene	20,276	1,000	2.0×10^7	6.1	9.1
1971	Butadiene	19,200	27,000	5.18×10^8	0.245	0.365
1974	Cyclohexane	18,676	120,000	2.2×10^9	70	82.6
1974	$\geq C_5$ (Unsaturated)	19,000	16,800	3.192×10^8	13.2	15.6
1975	Ethylene	20,276	12,000	2.4×10^8	40	42.8
1975	H ₂	51,571	665	3.4×10^7	2.75	2.91

Written by J. ROTH

Refs: 1) C.R. Fuget, BRL Rept 1419 (1968), (AD-393-688) 2) E.B. Vanta et al, AFATL-TR-73-3 (1973) (AD-908-999L) 3) M.C. Miller, EC-TR-74029 (1973) (AD-919-923L) 3a) R.W. Woolfolk & C.M. Ablow, Proc Conf Mechanisms of Explosions & Blast Waves (1973) 4) W.J. Robinson, AFATL-TR-74-69 (1974), (AD-921-118L) 5) N. Slagg et al, "Experimental and Theoretical Modeling of Fuel-Air Detonations: The Distributed Blast Concept", Army Science Conf, West Point (1974) (AD-785-681/8SL) 6) R.S. Fry & J.A. Nicholls, AIAAJournal 12, 1703 (1974) 7) P.A. Urtiew et al, "Free Radicals and Fuel-Air-Explosion Initiation", AFATL-TR-76-21 and UCRL-52007, ERDA, Lawrence Livermore Lab (1976) 8) S.A. Saia, ChemEngProgr 72, 56 (1976) 9) B.D. Fishburn, ActaAstronautica 3, 1049 (1976)

10) J.A. Davenport, ChemEngProgr 73, 54 (1977) 11) R. Knystautas & J.H. Lee, "Photochemical Initiation of Detonation in Gaseous Explosive Media", McGill Univ, Montreal (1977), (AD-A041-504/2ST) 12) C.D. Lind & J.C. Whitson, "Explosive Hazards Associated with Spill of Large Quantities of Hazardous Materials", Naval Weapons Center, China Lake (1977), (AD-A047-585) 13) R. Knystautas & J.H. Lee, "Mechanisms of Initiation of Detonation in Explosive Vapor Clouds", McGill Univ, Montreal (1977), (AD-A051-854/8ST) 14) S.A. Gubin et al, CombustExplosShockWaves 14, 71 (1978) 15) T. Gadian, ChemInd(London) 1978, 293 16) P.L. Lu et al, "The Effects of Physical and Chemical Processes on Two-Phase Detonations" (1978), (AD-A056-464/1ST) 17) E.E. Meister, "An

Investigation of the Ignition Delay Times for Propylene Oxide-Oxygen-Nitrogen Mixtures", Air Force Office of Scientific Research (AFOSR), Bolling AFB, Washington, DC (1978), (AD-A072-623) 18) V.V. Mitrofanov et al, *Acta-Astronautica* 6, 281 (1979) 19) M. Gerstein, "AFOSR Contractors Meeting (1978) on Unconfined Fuel-Air Explosions (FAE) and other Combustion/Explosion Related Research" (1979), 30, (AD-A064-799/OST) 20) Y. de Longueville, *Ibid*, p 1 21) E.K. Dabora, *Ibid*, p 23 22) C.N. Kingery & J.D. Sullivan, *Ibid*, p 9 23) M. Rosenblatt et al, *Ibid*, pp 10-13 24) N.A. Messina & M. Summerfield, *Ibid*, p 52 25) D.J. Lewis, *Ibid*, p 55 26) A.J. Tullis, *Ibid*, p 18 26a) R.T. Sedgewick & T.H. Pierce, *Ibid*, p 50 27) I.O. Moen, "Report on AFOSR Workshop on FAE III" (1979), 1-38, (AD-A068-912/5ST) 28) W. Wilson, *Ibid*, p 54 29) G. von Elbe & E.T. Hale, *Ibid*, pp 40-51 30) *Ibid*, "Chemical Initiation of FAE Clouds", AFOSR, Bolling AFB, Washington, DC (1979), (AD-A082-610/7)

Vapor Phase Nitration. See under "Nitration" in Vol 8, N48-R & N56-L, and under "Nitromethane", M69-R

Vapor Pressure of Explosives

I. Introduction

The *Vapor Pressure* of a substance is the pressure of its gaseous phase in equilibrium with its condensed phase. Vapor Pressure is strongly dependent on ambient temp. Thus, the *boiling point* of a substance is the temp at which its vapor pressure equals that of the ambient atm. The heat required to change a unit weight of solid substance to vapor is known as the *heat of sublimation*, and that of a unit weight of liquid is known as the *heat of vaporization*

The impetus for the study of the *vapor pressure of expls* has been provided in the past by considerations of health and safety. For example, TNT vapors are toxic, while those of Nitroglycerin (NG) and Ethyleneglycoldinitrate (EGDN) produce severe headache. Consequently, to protect workers in manufacturing plants and

users in the field, it became necessary to measure vapor pressures of these and other expls in order to establish allowable vapor concn limits. Furthermore, there was justifiable concern about vapors of expl substances getting into electric light fixtures, being exposed to sparks, and generally providing a source of accidental explns or fires. In more recent years, as the kinetics of thermal decompn of expls began to be studied, questions arose whether partial vaporization and vapor phase decompn were important at temps well below the boiling point of the expl. Very recently, as criminal bombings became a matter of international concern, bomb detection schemes based on detection and identification of vapors of the expls used in such bombs were proposed. Expl vapor detection will not be addressed in this article (see under "Tagging of Explosives" in Vol 9). The interested reader is referred to a summary contained in Ref 25

In previous Encyclopedia volumes cursory mention of vapor pressure was made primarily in articles on important expls. Thus, there are some vapor pressure data for NG in Vol 6, G98-R; PETN, Vol 8, P86-R; Petrin, Vol 8, P85-L; Picric Acid, Vol 8, P286-R; and RDX, Vol 9, R120-R. The present article is primarily directed to the compilation of the *best available* vapor pressure data for expls. Also included in the article will be a discussion of the major techniques for measuring the vapor pressure of expls, since there is disagreement in results among some of these methods. Although a detailed description of the *thermodynamic* relations pertaining to vapor pressure is quite beyond the scope of the present article, a brief discussion of the Clausius-Clapeyron equation is given below because of the importance of this relation in vapor pressure measurements and in the interpolation and extrapolation of vapor pressure data

At equilibrium between two phases, the chemical potential of phase one equals that of phase two. If the temp of the system is changed slightly, and equilibrium is re-established, the pressure must change to maintain equality of the chemical potentials. For a pure substance this condition is met if:

$$dP/dT = \Delta S/\Delta V \quad (1)$$

where P and T are pressure and absolute temp, ΔS is the entropy change and ΔV is the volume

change for the phase transition. Because the phases are in equilibrium, for a reversible process

$$\begin{aligned} \Delta S &= \Delta H/T & \text{and} \\ dP/dT &= \Delta H/T\Delta V \end{aligned} \quad (2)$$

where ΔH is the enthalpy change for the transition. Equation 2 may be applied to any phase equilibrium. For vaporization or sublimation, where vapor pressures are low enough so that the vapors behave as nearly ideal gases and the molar volume of the condensed phase is negligible in comparison with the vapor volume, Eq 2 becomes

$$\begin{aligned} dP/dT &= P\Delta H/RT^2 & \text{or} \\ d\ln P/dT &= \Delta H/RT^2 & \text{or} \\ d\ln P/d(1/T) &= -\Delta H/R \end{aligned} \quad (3)$$

According to Eq 3, a plot of $\ln P$ vs $1/T$ should be a straight line of slope $-\Delta H/R$, provided ΔH is not a function of T . In practice ΔH does vary with T , but only slowly. Thus Eq 3 is a good approximation for the variation of vapor pressure with temp over small to moderate temp ranges. Over large temp ranges, the following empirical correlation is often used:

$$\ln P = A/T + B \ln T + CT^2 \quad (4)$$

where A , B and C are empirical constants

II. Methods of Measurement

A variety of methods has been used in measuring the vapor pressure of expls. In general these may be classified (in chronological order) as:

- Differential pressure measurements
- Weight loss measurements
- Boiling point measurements (under reduced pressure)
- Effusion methods (Knudsen apparatus)
- Direct measurement
- Langmuir method (refluxing liquids)
- Gas chromatography

Brief descriptions of these methods are given below:

a) The *differential method* is described in detail in Ref 1. Basically it consists of direct pressure measurement of an inert gas upon which is superimposed the vapor pressure of a small sample of the test material in equilibrium with its condensed phase. A sensitive pressure gage is required, eg, a McLeod gage, and the volume of the pressure gage must be small in comparison to the volume of the sample and inert gas container. Of course the entire system must be thermostatted. The system is calibrated by measuring the increase in pressure of the inert gas (without sample) with temp and comparing these measurements with calcs via the perfect gas law. This method gives erroneous results if the test material contains volatile impurities.

Furthermore, if the final pressure of inert gas plus vapor is little different from that of the inert gas by itself, there is the usual potentially large error in measuring the difference between two almost equal quantities

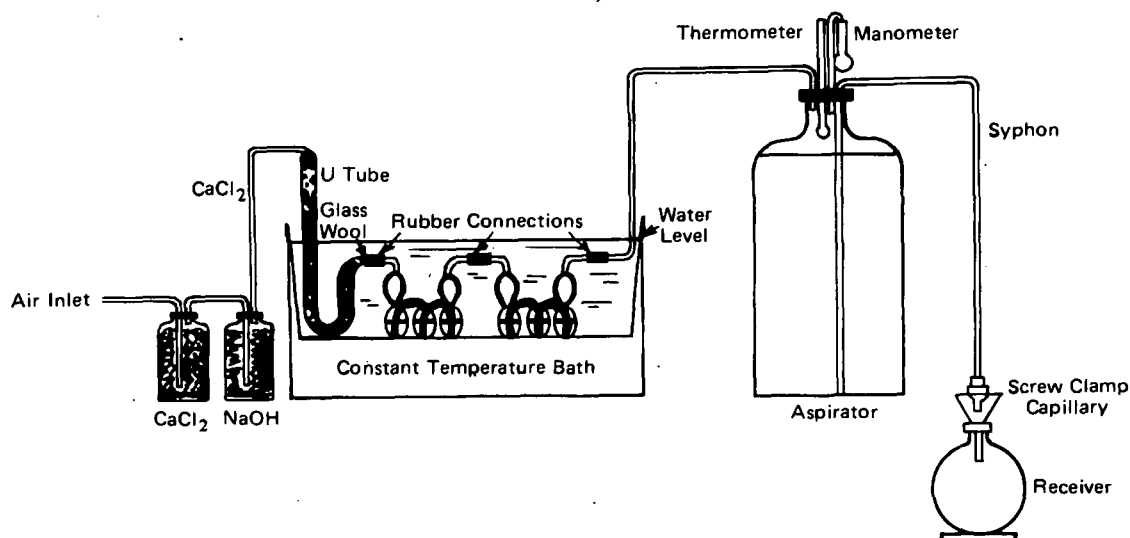

Fig 1 Weight Loss Measurement Technique

b) *Weight loss measurements* were used to obtain vapor pressures of *liquid* nitrate esters in Refs 2, 3, 4, 10 & 17d. A typical arrangement is shown in Fig 1, taken from Ref 3. Known quantities of pure dry air were bubbled thru the thermostatted test material and its loss in weight was determined. The test material was contained in two Geissler tubes. To prevent unsaturation of the air, flow was adjusted such that weight loss in the first tube was much greater (about one hundred-fold) than in the second tube. Tubes were weighed before and after air passage. A small correction is required to allow for the pressure drop in the air drying train (Ref 4). Similarly to method (a), this technique gives erroneous results if the sample contains volatile impurities, eg, moisture

c) Accurate temp measurement of *boiling points* at reduced ambient pressure is a viable method of measuring vapor pressure, *provided* the test material does not decompose or decomps slowly enough at these temps. This technique was used in Ref 5. The sample was rapidly introduced into a temp bath some 30° above the boiling point to be measured. The boiling point was determined by measuring the temp of the condensing vapor above but close to the sample surface. Volatile impurities should not affect the accuracy of these measurements, but rapid sample decompn could result in erroneous measurements

d) In the *effusion method* the loss of vapor thru a hole of diameter less than the mean free path of the vapor gives a measure of the vapor pressure. The loss in weight of a container (with a small diameter hole) plus sample is measured as a function of time at a fixed temp. The vapor pressure is estimated using

$$m^2/t^2 = p^2 A^2 M / 2\pi RT$$

where m is in g, t in sec, p in dyne/cm², A in cm², R in erg/deg and M is the molecular weight in g. This method was employed successfully in Refs 6, 9, 13, 15, 17 & 24. Since this appears to be a viable technique, a more complete description of the apparatus is appropriate. We quote from Edwards (Ref 6): "The apparatus used in the present experiments is shown in Fig 2. A pure liquid, the boiling point of which is known, was heated in the reboiler by passage of an electric current in the Nichrome coil A.

Vapour from the liquid passed in a rapid stream up the inside of the funnel B and down the outer annulus to the vapour condenser C. The condensate re-entered the boiler at the base by way of the return pipe D. The outer shape of the upper section of the reboiler was constructed to conform accurately to the B.S.S. Joint B₃₄³ and was fitted to the Pyrex glass vacuum chamber as shown, lubrication being effected by Dow-Corning silicone lubricant. Approximately 1 cm. above the heater and concentric with it was a Pyrex glass condenser with a deep recess of the same internal diameter (0.375 in.) as the box heating chamber. The box containing the trinitrotoluene could be retained in this by the rotatable arm E until the apparatus was fully evacuated. Evacuation was effected by a pumping system consisting of three stages of oil-condensation pumps backed by a two-stage oil rotary pump. This system reduced the pressure to less than 10⁻⁵ mm. Hg (ionization gauge).

The box used was of polished aluminium and could be fitted with one of three lids with holes 0.0568, 1.068 and 1.250 mm. diam. respectively. The overall diameter of the box was 0.370 in. and height 0.375 in., and its weight almost exactly 1 g.

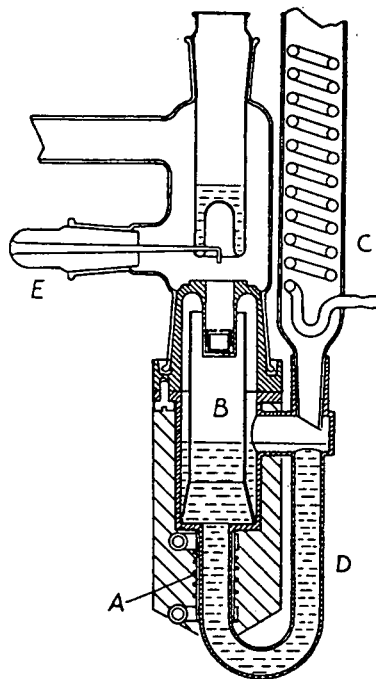

Fig 2 (From Ref 6)

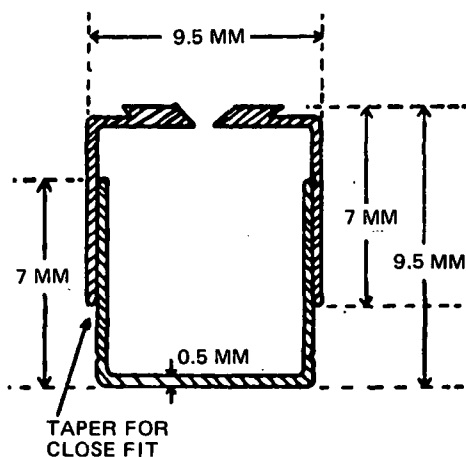

Fig 3 Effusion Cell (Vertical Section) (from Ref 17)

The mass of the box and trinitrotoluene were measured to 0.1 mg. on an analytical balance. The heater was removed from the glass vacuum chamber and the box pushed into the condenser recess and retained by the rotatable arm. The heater was brought up to its working temperature and inserted in the B_{34} joint of the vacuum chamber. Vacuum was applied and when conditions had stabilized the box was released from the condenser. The condenser was then charged with alcohol and powdered solid carbon dioxide. At the end of the test the vacuum was broken and the box removed for reweighing."

A sketch of the polished Dural effusion cell used in Ref 17 is shown in Fig 3. Two such cells were used with knife edge orifices of diameter 0.602 & 1.012mm and length of 0.1104 and 0.1132mm, respectively

e) *Direct measurements* using a manometric technique were made by Edwards (Ref 6) and Maksimov (Ref 11). The apparatus employed by Edwards is shown in Fig 4. Its use is described by Edwards as follows: "A manometer of suitable length is constructed with 15 ml bulbs in each limb, as shown, Initially one limb of the manometer is extended as shown at A. Two bulbs of about 15 ml capacity, each containing approximately 5 ml of the test substance, are fused on as shown at B and C. These are tilted backward (into the plane of the paper) as shown in the drawing D. The manometric liquid is introduced at A so that none enters the test substance bulb C. The apparatus is rotated into a horizontal position so that the manometric liquid flows

into the bulbs on the limbs while the test liquid is retained in bulbs B and C. A constriction is made in the tube A and the apparatus evacuated through this using a vapour diffusion pump and rotary oil pump with suitable cold-trap protection:

The whole apparatus is baked as efficiently as possible without evaporating large quantities of the manometric fluid or test substance, and is finally sealed off. The apparatus is returned to the vertical position and wholly immersed in a thermostatic bath. The level of the manometer liquid should be exactly equal under these conditions. The apparatus is then arranged as shown in the sketch with bulb B in solid carbon dioxide or liquid nitrogen. When equilibrium is attained the difference of level in the manometer limbs is observed with a cathetometer. The thermostat temperature is readjusted and the process repeated."

f) The *Langmuir method* measures rates of sublimation at constant temp. In this method, used in Refs 14 & 18, samples were heated in a vacuum and vapor pressures calcd from the following relationship:

$$P = 17.14G (T/M)^{1/2}$$

where P is the vapor pressure in torr, G is the observed weight loss in grams/cm²/sec, T is the absolute temp, and M is the molecular weight

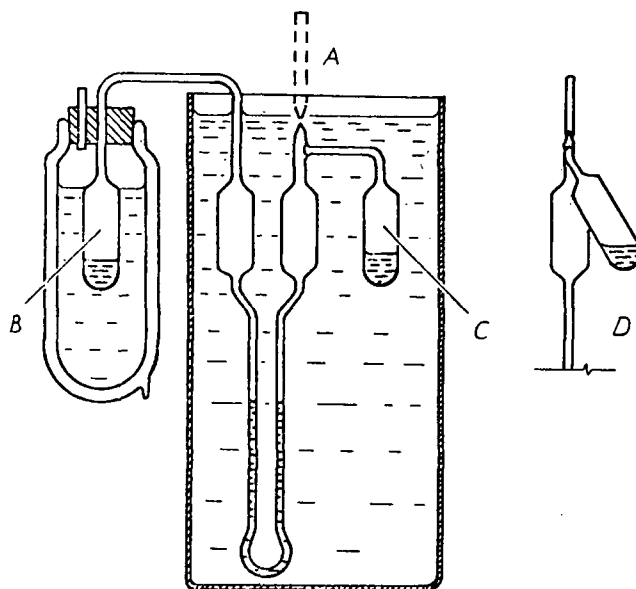

Fig 4 (from Ref 6)

Samples, after having been weighed, were placed in a jacketed section of a glass-vacuum apparatus. The apparatus was sealed and the system evacuated to approximately 5×10^{-7} torr. Constant temps were provided by a series of liquids (Table 1) maintained at the boiling point. The sample was heated by passing the vapors of a boiling liquid thru the jacket of the sample section. Two 500-ml round-bottomed flasks heated by electric mantles and located near the ends of the jacketed section were used for the boiling liquid, and the vapors were condensed by a single water-cooled condenser located at the center of the jacketed section. During the heating process, the jacketed section, as well as the necks and exposed regions of the flasks were covered with 1–2 layers of aluminum foil. A safety shield was placed around the vacuum apparatus. The shield consists of 1/4" thickness of tempered masonite across the back, and 1/4" thickness of Lexan plastic across the front and sides

Following the period of vacuum heating, the samples were re-weighed. Several of the samples were analyzed for chemical purity in order to determine the presence of decompn products

Table 1
Temperature of Reflux Liquids

Liquid	Boiling Temp. °C ^a	Temp in Vacuum Apparatus °C
Methyl acetate	57.4	55.7
Methanol	64.4	62.6 ^b
Benzene	80.1	78.2
n-Propanol- water azeotrope	87.3	85.3 ^b
Water	99.8	97.7 ^b
Toluene	110.3	108.1
n-Butanol	117.8	115.6
Chlorobenzene	131.8	129.3
m-Xylene	138.8	136.2
Anisole	152.7	150.0
Mesitylene	164.4	161.4 ^b
Phenetole	169.4	166.3
o-Dichlorobenzene	180.5	177.3
Benzonitrile	189.3	185.8
Nitrobenzene	210.3	206.3 ^b

^a At 755 torr atmospheric pressure

^b Temperatures determined by thermocouple measurements with external pressure of 755 torr

g) The *Gas Chromatography method* appears to be favored in recent studies, Refs 16, 20, 21, 22 & 23. It has the decided advantage that volatile impurities can be separated out in the Chromosorb column. The apparatus used in this method is illustrated in Figs 5 & 6, taken from Refs 20 & 21. It is somewhat over-elaborate since its main function was to act as a vapor generator. The UFC & DFC in Fig 5 represent upstream and downstream differential flow controls

Equilibrium vapor is generated by passing dry nitrogen over the expl sample dispersed on an inert support (Chromosorb) and placed in the thermostatted spiral glass tube shown in Figs 5 & 6. Flow rate of nitrogen was sufficiently slow (10–100ml/min) to allow saturation with the expl's vapor. The temp of the glass tube containing the expl was controlled so that the

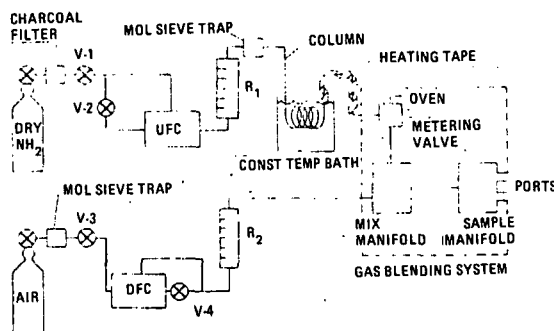

Fig 5 Schematic Diagram of Vapor Generator

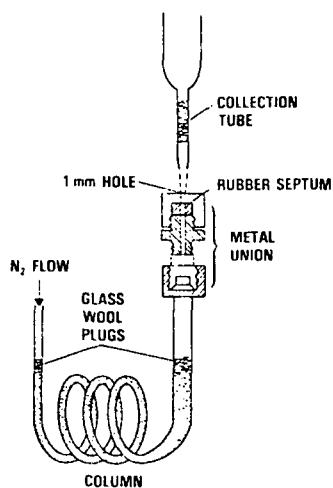

Fig 6 Collection of Equilibrium Vapor Concentrations (shown outside temperature bath)

equilibrium vapor concn could be varied. Temps were maintained constant within $\pm 0.05^\circ\text{K}$ and are accurate to within $\pm 0.1^\circ\text{K}$. To measure the mole fraction of vapor, a known volume of vapor is first collected on glass wool. The adsorbed expl is then eluted with a solvent. The mole fraction of the expl material in soln is measured by comparing the chromatographic peak area with that obtained from a standard solution. The vapor sample withdrawal technique is illustrated in Fig 6

Leggett et al (Refs 22 & 23) used a similar technique, except that their apparatus was "static". TNT samples were placed in a 125ml vial equipped with silicone rubber septum cap. The vial was thermostatted and the sample and its vapor were allowed to equilibrate for 2–4 weeks. Vapor was withdrawn from the "headspace" with a stainless steel syringe and injected into a gas chromatograph. The concn of TNT in the headspace vapor was determined by manual triangulation of the peak, giving peak area/volume, and dividing by the detector response factor (peak area/mass), as determined by injection of known quantities of TNT dissolved in benzene

Leggett (Ref 22) and Coates et al (Ref 16) used electron capture detectors. Leggett specifies his chromatographic conditions as follows:

Column, 1.8m stainless steel (316)

Packing, 10% Dexsil 300 GC on 100–120 mesh, Anakrom ABS (Analabs, North Haven, Conn, USA)

Carrier gas, specially purified nitrogen at 50ml/min

Temperatures, Injector, 250°C ; column, 190°C ; manifold, 200°C ; detector, 190°C

Detector, titanium tritide operated in the pulse mode at 50V amplitude, 1- μsec pulse width, and 100- μsec pulse interval

III. Vapor Pressure Data

TNT and EGDN are two expls whose vapor pressure has been measured more often than any other expls. They also serve to illustrate the degree of disagreement (TNT) and accord (EGDN) among various vapor pressure studies. Consequently, in what follows, the vapor pressure data for TNT and EGDN will be presented in greater detail than for other expls. Subsequently, vapor pressure data will be grouped, insofar as possible, according to expl type, eg, nitrate esters, nitramines, etc. Whenever adequate information is available, the actual data will be in the form of:

$$\log p = A - B/T \quad (5)$$

where A and B are constants, p is in Torr (mm of Hg) and T in $^\circ\text{K}$. Heats of vaporization or sublimation will be presented in the next section

Table 2 shows the vapor pressure of EGDN

Table 2
Vapor Pressure of EGDN (Torr)

Temp $^\circ\text{C}$	Marshall (Ref 3a)	Brandner (Ref 4)	Crater (Ref 3)	Rinkenbach (Ref 2)	Pella (Ref 20)
-5	—	0.004 (a)	—	—	0.004
0	—	0.0065 (a)	—	0.007	0.0067 (b)
15	—	0.031	0.023	—	—
22	—	0.058	0.053	0.057	—
25	—	0.078	0.071	—	0.075
35	—	0.196	0.219	—	—
40	0.26	—	—	—	0.28 (a)
45	—	0.448	0.443	—	0.427 (a)
50	—	0.648	0.652	—	—
60	1.3	—	—	—	1.3 (a)
80	5.9	—	—	—	5.0 (a)

(a) extrapolated

(b) interpolated

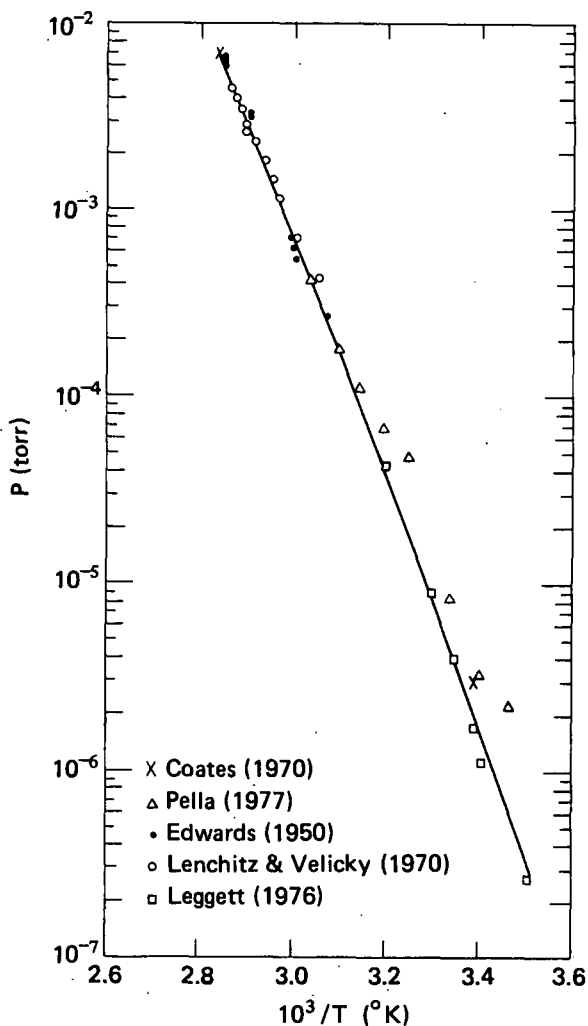

Fig 7 Vapor Pressure of 2,4,6-Trinitrotoluene

over the temperature range of -5 to 80°C . Accord among the five different sources is excellent. In three of these studies method (b) (see Section II) was used, method (g) was employed in one study, and the method for one source (Marshall) is not specified

Pella's empirical fit (Ref 21) appears to represent all the data in Table 2:

$$\log p = 10.55 \pm 0.08 - (3476 \pm 22) / T$$

The situation with TNT is not nearly so well defined. This is shown for solid TNT in Fig 7, taken from Ref 22, and additional datum points added by the writer. This disagreement between published values of the vapor pressure of TNT is further emphasized by the following empirical equations (p in Torr):

Pella (Ref 20) $\log p = 12.31 - 5175/T$
Wood's measurements (quoted in Ref 23) agree quite well with this fit

Lenchitz & Velicky (Ref 17)

$$\log p = 13.08 - 5401/T$$

Edwards (Ref 6) $\log p = 15.75 - 6318/T$

Leggett (Ref 22), over a range of 12 to 30°C

$$\log p = 19.25 - 7371/T$$

Nitta et al (Ref 7) $\log p = 13.90 - 5348/T$

Their values lie parallel but considerably above the line in Fig 7

At temps over which TNT is liquid the following empirical equations have been published:

Edwards (Ref 6) $\log p = 10.90 - 4960/T$

Robertson (Ref 5) $\log p = 9.11 - 3850/T$

Nitta (Ref 7) $\log p = 10.39 - 4086/T$

Obviously, as shown in the next section, these fits lead to discordant values of the heat of vaporization

The cause of the disagreement among the above studies is not clear. For example, both Edwards and Lenchitz & Velicky used the effusion method and covered about the same temp range in their measurements. Nitta et al also used the effusion method, and their temp range is within those of the above studies. Similarly, Pella and Leggett used the gas chromatography (GC) method, and their temp ranges overlap. Thus neither method of measurement nor temp range will explain the discord in published TNT vapor pressure data. Presence of volatile impurities might explain the high results of Nitta et al (although this is purely a supposition), but both Pella and Leggett used very pure TNT and their method (GC) should be unaffected by the presence of impurities

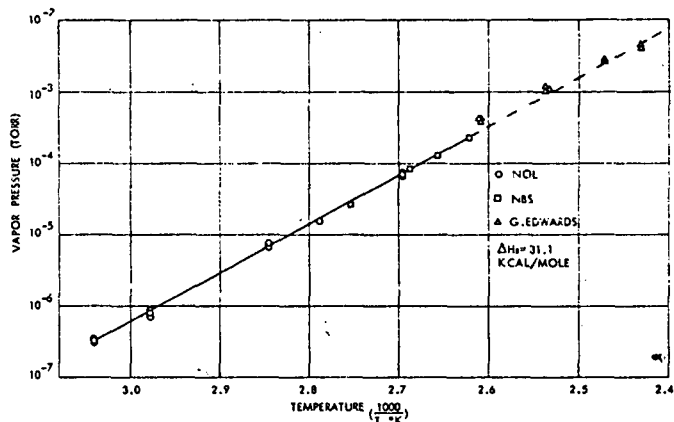

Fig 8 Vapor Pressure of RDX

We now present empirical equations for the vapor pressure of expls grouped according to type (all pressures in Torr and temps in °K):

Nitrate Esters	log p (Torr)	Ref
Methyl nitrate	7.85-1694/T	3b
EGDN	10.55-3476/T	21
NG	10.86-4186/T	4
NG	14.42-4962/T	10b
NG	13.28-4930/T	(a)
DEDGN	13.19-4975/T	10a
PETN(s)	17.73-7750/T	9
PETN	14.44-6352/T	15

(a) our "eyeball" best Eq 5 line thru all the published NG data

Obviously there is wide disagreement among published values of the vapor pressure of NG and PETN. We have attempted to select a "best" value for NG as (a) above

Nitramines	log p (Torr)	Ref
RDX	11.87-5850/T	9
RDX	14.18-6800/T	14
β -HMX	16.18-9156/T	14
δ -HMX	14.95-8446/T	19
Diethylnitramine(liq)	11.80-3650/T	17a
Dimethylnitramine	8.30-2595/T	17a

Combining the RDX data of Refs 14 & 9 with unpublished data from NBS, Rosen and Dickenson (Ref 14) draw the plot shown in Fig 8. The NBS data was obtained via the effusion method. According to Fig 8 the fit of Ref 14 is to be preferred to that of Ref 9

The differences in the HMX data of Refs 14 & 19 is probably due in part to differences in crystal structure. Over the temp range of Ref 14, HMX is primarily in the β form, while in Ref 19 it is mostly in the δ form. Of course there is also a difference in measurement methods - the Langmuir method in Ref 14 and the effusion method in Ref 19

Nitroaliphatics	log p (Torr)	Ref
Nitromethane	7.69-1800/T	3a
Trinitromethane (s)	8.727-2436/T	12
Trinitromethane (liq)	6.266-1702/T	12
Tetranitromethane (TNM)	8.23-2130/T	8
Hexanitroethane (HNE)	11.42-3704/T	13

Clearly there are relatively few data for polynitroaliphatics

Nitroaromatics	log p (Torr)	Ref
TNT	12.31-5175/T	21
TNT	13.08-5401/T	17
TNT	13.90-5438/T	7
TNT	15.75-63.8/T	6
TNT	19.25-7371/T	22
2,4 DNT	13.08-4992/T	21
2,4 DNT	12.59-5130/T	17
2,6 DNT	13.99-5139/T	21
TNB	11.83-5077/T	7
Trinitroanisole	17.25-6918/T	7
2,4 Dinitrophenol	13.95-5466/T	17a
2,6 Dinitrophenol	14.25-6451/T	17a
Trinitroaniline (TNA)	14.18-6054/T	14
DATB	13.73-7316/T	14
TATB	14.73-8789/T	14
HNS	14.19-9401/T	14

As already mentioned there is wide divergence of measured values of the vapor pressure of TNT. For DNT the two published values of the relation between p and T agree well. There appear to be no replicate vapor pressure measurements for the other expls listed above

Azides	log p (Torr)	Ref
HN ₃	8.20-1643/T	4a
Ethyl N ₃	8.01-1644/T	7a

Vapor pressure data on azides appear to be very scarce

IV. Heats of Sublimation and Vaporization

Both these quantities (also known as *enthalpies* of sublimation or vaporization) vary with temp, but usually only mildly. Ideally, comparisons among the heats of sublimation or vaporization of various compds should be made at some standard temp, eg, 25°C (298°K). Whenever possible, in what follows, we will use the values given in Cox & Pilcher (Ref 17a) since they are corrected to 25°C. These values will be marked with an *asterisk*. Heats not listed in Cox & Pilcher will be taken directly from the various publications. Often these are average values over the temp range studied. Because of their mild variation with temp, comparison of standard and average values appears to be permissible. Heats of sublimation or vaporization will be grouped as in the preceding section and will be given on both a per mole and per gram basis

In a homologous series of compds, one would

expect the specific heats of sublimation or vaporization (on a per gram basis) to be constant. This expectation is often verified. In many instances, however, the specific heats of sublimation or vaporization of rather similar compds differ appreciably. Such differences indicate differences in *intermolecular* forces, eg, different degrees of intermolecular hydrogen bonding. This subject will be further discussed in specific cases

Probably the most consistent set of values of heat of vaporization is that of *nitrate esters*. This is shown in Table 3

Included for comparison in this Table is the heat of vaporization of liq nitric acid. Omitting this value, 0.10Kcal/g is a good average for the entire grouping

It is of some interest to apply Trouton's rule (entropy of vaporization at the boiling point is a constant) to the above data. Unfortunately, boiling points are known only for nitric acid and some of the aliphatic nitrates. Their Trouton constants ($\Delta H_{\text{vap}}/T_{\text{bp}}$) are 20.2 and ca 22.8 entropy units, respectively. Thus they straddle the "normal" Trouton constant of 21 eu. This observation, coupled with the observed constancy of the specific heat of vaporization, suggests that intermolecular bonding in nitrate esters may be relatively weak, or at least consistent

Let us examine the heat of sublimation of

PETN obtained by Edwards (Ref 9). If we take 10 Kcal/mole as the heat of fusion (see Vol 8, P86-R), and 36.3Kcal/mole as the heat of sublimation (Ref 9), then, neglecting small temp corrections, the heat of vaporization is ~ 26.3 Kcal/mole or ~ 0.083 Kcal/g, which is somewhat less than the heats of vaporization of other nitrate esters (see Table 3). Crimmins (Ref 15) gives the heat of sublimation of PETN (at 298°K) as 29.0Kcal/mole. Thus the specific heat of vaporization, computed as above, would be substantially lower than 0.083Kcal/g. Crimmins is aware of Edwards' results, but provides no clue as to their disagreement even though the same techniques were used by Crimmins and Edwards. Incidentally, Crimmins appears to have recomputed Edwards' results to get a standard (at 298°K) heat of sublimation of 33.9Kcal/mole. Cundall et al (Ref 24) obtain 35.9Kcal/mole for the standard heat of sublimation, which is very close to the "average" heat of sublimation given by Edwards (Ref 9). Dinigar and Stammer (Ref 17d), using thermogravimetric weight loss measurements, obtained 35 ± 3 Kcal/mole for the heat of sublimation of PETN, in good agreement with Edwards or Cundall et al. They measured 25 ± 2 Kcal/mole for the heat of vaporization with some sample decompn. When they "correct" for sample decompn (in a more than somewhat debatable manner), they obtain 19 ± 2 Kcal/mole

Table 3
Heats of Vaporization of Nitrate Esters

	Kcal/mole	Kcal/gram	Ref
HNO ₃ (liq)	7.24	0.115	(a)
MeNitrate	8.15 *	0.106	17a
MeNitrate	7.75	0.101	3a
EtNitrate	8.67 *	0.095	17a
n-PrNitrate	9.70 *	0.092	17a
iso-PrNitrate	9.27 *	0.088	17a
EGDN	15.9	0.104	21
NG	23.9 *	0.105	17a
NG	22.6	0.100	(b)
DEGDN	22.3	0.103	10b
1,3 Dinitratopropane	17.8	0.107	10
1,3 Dinitratobutane	17.2	0.096	10
1,5 Dinitratopentane	18.8	0.097	10

(a) From Handbook of Chem and Physics, included for comparison

(b) "Average" of data of Refs 4, 10, 10b & 17b

Table 4
Heats of Sublimation and Vaporization of Nitramines

	Sublimation		Vaporization		Refs
	Kcal/mole	Kcal/g	Kcal/mole	Kcal/g	
RDX	31.1	0.140	22.6 (a)	0.102	14
RDX	26.8	0.121	—	—	9
RDX	32.1 *	0.145	—	—	24
β -HMX	41.9	0.142	—	—	14
δ -HMX	38.7	0.131	—	—	19
δ -HMX	38.5 *	0.130	—	—	24
Dimethylnitramine	16.7 *	0.185(?)	—	—	17a
Diethylnitramine	—	—	12.7 *	0.108	17a

(a) 31.1–8.5 where 8.5 = heat of fusion (see RDX, Vol 9, R123-L & Ref 17c)

Table 5
Heats of Sublimation and Vaporization of TNT

Investigator and Ref	Method	Temp Range (°C)	ΔH_{subl} Kcal/mole	ΔH_{vap} Kcal/mole
Leggett (22)	GC	12–40	33.7(b)	—
Pella (20)	GC	14–56.5	23.7	—
Lenchitz & Velicky (17)	Effusion	55–76	24.7	—
Nitta et al (7)	Effusion	67.7–88	24.5	18.7
Edwards (6)	Effusion	52–141	28.3	22.7
Wood (a)	?	28–59	25.6	—
Cundall et al (24)	Effusion	28–76	27.0 *	20.8 *
Robertson (5)	Boiling point	227–345	—	17.5

(a) quoted in Ref 22

(b) omitted in average

for the "heat of vaporization"

Heats of sublimation and vaporization of *Nitramines* are presented in Table 4. Note that heats of sublimation and vaporization on a per gram basis appear to be constant. Edwards' data (Ref 9) and those of Dimethylnitramine are probably in error. Also note that the specific heats of vaporization are close to those of the nitrate esters (Table 3)

Since the heat of sublimation and vaporization of TNT has been studied by numerous investigators, albeit with discordant results, these quantities are presented here in Table 5. Note that neither temp range of measurements nor method of measurement accounts for the variability of results

The heats of sublimation of mon-, di and trinitro aromatics are listed in Table 6. Consider the nitrobenzenes for which the specific heats of sublimation are 0.117, 0.115 and 0.109Kcal/g for the mono-, di- and trinitro derivatives, respectively. In this grouping, the specific heats of sublimation are essentially constant. This is not the case for the nitrotoluenes, for which the corresponding heats of sublimation are 0.138, 0.129 and 0.113Kcal/g. For the nitroanilines these values are 0.151 and 0.122Kcal/g for o-MNA and 2,4,6-TNA, respectively

The apparent near constancy of the specific heats of sublimation of the nitrobenzenes suggests a similarity in their intermolecular forces, eg, a

similar degree (or even absence) of hydrogen bonding between molecules. For the nitrotoluenes and nitroanilines, intermolecular forces appear to be greater for the mono- derivatives than for the di- or tri- compds. For the nitroanilines (and presumably for the nitrophenols),

Table 6
Heats of Sublimation of Nitroaromatics

	Kcal/mole	Kcal/g	Ref
MNB	14.4 (a)	0.117	11
p-MNT	18.9	0.138	17
o-MNA	20.9 *	0.151	17a
m-MNA	22.7 *	0.164	17a
p-MNA	25.5 *	0.185	17a
2,4 DNB	18.7 (b)	0.111	11
2,4 DNB	19.4 *	0.115	17a
2,4 DNT	22.9	0.126	21
2,6 DNT	23.5	0.129	21
2,4 DNPhenol	25.0 *	0.136	17a
2,6 DNPhenol	26.8 *	0.146	17a
DATB	33.5	0.138	14
DATB	34.3 *	0.141	24
1,3,5 TNB	23.2	0.109	7
1,3,5 TNB	23.0 (c)	0.108	11
1,3,5 TNB	25.6 *	0.121	24
2,4,6 TNT	25.0	0.113	(d)
2,4,6-m-TNC (g)	26.5 *	0.109	24
Picric Acid	25.1	0.110	24
2,4,6 TNA	27.7	0.122	14
TATB	40.2	0.156	14
2,4,6 Trinitroanisole	31.6	0.130	7
2,4,6 Trinitrophenethole	28.8	0.112	7
HNS	43.0	0.096	14
Tetryl (f)	32.0 *	0.111	24
Styphnic Acid	28.9 *	0.118	24
TNM (e)	24.8 *	0.097	24

- (a) Added 2.8Kcal/mole heat of fusion to heat of vaporization in Ref 11
 (b) Added 4.2Kcal/mole heat of fusion to heat of vaporization in Ref 11
 (c) Added 5.5Kcal/mole heat of fusion (assumed same as for TNT) to heat of vaporization in Ref 11
 (d) Average of values in Table 5
 (e) Trinitromesitylene
 (f) Also a nitramine
 (g) Trinitroresol

hydrogen bonding is the likely cause of these stronger molecular interactions. Bearing on this subject is an interesting discussion in Ref 14 on the causes of the decreasing specific heats of sublimation in the grouping TATB, DATB and TNA. Note that the specific heat of sublimation of HNS (in effect a "double" TNT) is lower but of the same magnitude as that of TNT. Probably most of this difference is explicably in terms of the much higher temp range over which the HNS data was obtained: midpoint temp ranges are 184°C for HNS and ca 60°C for TNT

The cause for the apparent difference in specific heats of sublimation of trinitroanisole, 0.130 Kcal/g, and trinitrophenethole, 0.112Kcal/g, is not clear. These are very similar compds with an -OCH₃ grouping for the former and an -OC₂H₅ grouping for the latter. According to Table 6, the "average" specific heat of sublimation of trinitro aromatic compds is about 0.11Kcal/g, *provided* intermolecular hydrogen bonding or other types of intermolecular association is absent

We were able to find heats of vaporization with measurements over an extended temp for only two polynitroaromatic compds, namely TNT and TNB. For the former (from Table 5) the specific heats of vaporization range from 0.077 to 0.100Kcal/g, while for the latter (from Ref 11) they are 0.082 to 0.087Kcal/g. From measurements over a narrow temp range, Nitta et al (Ref 7) obtain 0.90Kcal/g and 0.73Kcal/g for the heats of vaporization of trinitroanisole and trinitrophenethole, respectively. Thus a rough "average" value of the *specific heat of vaporization of polynitroaromatic compds* is about 0.08Kcal/g. This value is probably too low for polynitro phenols or polynitroanilines

Heats of vaporization of nitroalkanes are shown in Table 7. The specific heats of vaporization suggest a descending strength of intermolecular forces in going from NM to the higher nitroaliphatics with a nearly constant molecular interaction for nitroaliphatics of higher molecular weight than nitropropane

For the polynitroaliphatics there is a further dramatic decrease in the specific heat of vaporization down to about 0.05Kcal/g. This is understandable if the intermolecular forces are largely hydrogen bonding. Obviously hydrogen bonding cannot exist for TNM and HNE, neither of

which contains hydrogen. Trinitromethane (nitroform) is a strong acid. The "normal" value of Trouton's constant for nitric acid (an even stronger acid) suggests that intermolecular hydrogen bonding does not occur in strong acids. The slightly higher specific heat of vaporization of chloronitroform (0.059Kcal/g) may be rationalized by an increased polarity effect due to the presence of the chloro group

Table 7
Heats of Vaporization of Nitroalkanes

	Kcal/mole	Kcal/g	Ref
Nitromethane	9.17*	0.150	17a
Nitroethane	9.94*	0.133	17a
1-nitropropane	10.37*	0.117	17a
2-nitropropane	9.88*	0.110	17a
1-nitrobutane	11.61*	0.113	17a
1,1-Dinitropropane	14.93*	0.111	17a
Trinitromethane (Nitroform)	7.8	0.052	12
Tetranitromethane	9.7	0.050	8
Tetranitromethane	10.3	0.053	5a
Hexanitroethane (HNE)	~16.9— 3.2(a)	~0.050	13
Chlorotrinitromethane	10.86	0.059	11a

(a) 16.9Kcal/mole is the heat of sublimation; 3.2Kcal/mole is the heat of fusion of Trinitromethane (Ref 11) which we assumed to be equal to that of HNE

Table 8
Heats of Vaporization of Azides

	Kcal/mole	Kcal/g	Ref
Hydrazoic Acid	7.29 *	0.170	10a
Ethyl Azide	7.53	0.106	7a
Cyclopentyl Azide	~10 *	~0.090	17a
Cyclohexyl Azide	~11 *	~0.088	17a

There are very limited data for the heats of vaporization of *azides*. These are shown in Table 8

According to Ref 10a, Hydrazoic acid molecules are linked into an infinite zigzag chain by N—H...N hydrogen bonds. Thus its high value of specific heat of vaporization is not unexpected. A fairly reliable Trouton constant of 23.5 eu for hydrazoic acid also suggests a non-ideal associated liquid. The other three azides in Table 8 have specific heats of vaporization similar to those of nitrate esters and nitramines

Incidentally, it seems that weak acids, eg, hydrazoic, nitrophenols and nitroanilines (note their large values of the specific heats of sublimation in Table 6) tend to form intermolecular hydrogen bonds, whereas strong acids, as discussed above, do not

Unpublished NBS data (Refs 17b and 26) give the heat of sublimation of TNETB (see Vol 6, E217-L for its structure) as 31Kcal/mole. Also obtained was an approximate heat of fusion of 5Kcal/mole. Thus an approximate heat of vaporization is 26Kcal/mole or 0.067Kcal/g. The latter is somewhat higher, but close to the specific heat of vaporization of polynitroalkanes (see Table 7)

Cundall et al (Ref 24) give 34.1Kcal/mole for the heat of sublimation of Nitroguanidine, which leads to 0.329Kcal/g! This extraordinarily high value of the specific heat of vaporization suggests a very high degree of intermolecular hydrogen bonding in consonance with the four potential bonding sites on each Nitroguanidine molecule

For ready reference we also include a table of *standard* heats (enthalpies), entropies and heats of formation of a variety of explosives. This table is taken from Ref 24. All values are in KJoules. To obtain the more commonly used Kcals, divide by 4.184. TNX is 2,4,6-Trinitro-m-xylene; TNM (in this table *only*) stands for 2,4,6-Trinitromesitylene, and TNC is 2,4,6-Trinitro-m-cresol

Table 9
Standard Enthalpies, Entropies and Gibbs Free Energies of Sublimation *
of Various Explosive Compounds (298.15 K)

	ΔH° /kJmol ⁻¹	ΔS° /Jmol ⁻¹ K ⁻¹	ΔG° /kJmol ⁻¹
TNB	107.3±0.6	116.6±0.5	72.5±1.2
TNT	113.2±1.5	146.2±1.3	69.6±3.0
TNX	129.8±1.1	167.0±1.8	80.0±2.7
TNM	103.6±1.2	117.3±1.6	68.6±2.8
TNC	111.2±2.1	126.0±5.0	73.6±6.7
Picric Acid	105.1±1.6	99.1±1.8	75.6±3.8
Styphnic Acid	120.8±1.1	135.0±1.8	80.6±2.5
TNA	125.3±0.8	140.7±0.3	83.3±1.2
DATB	143.5±2.3	148.5±4.5	99.2±5.8
Tetryl	133.8±1.6	155.8±2.0	87.3±3.2
RDX	134.3±0.7	153.6±0.4	88.5±1.2
HMX	161.0±0.3	152.7±4.0	115.5±1.9
PETN	150.4±1.3	215.4±2.6	86.2±2.9
Nitroguanidine	142.7±2.0	116.8±3.4	107.9±4.6
TNT (liquid)	87.0±1.9		

* Evaporation for liquid TNT

Written by J. ROTH

Refs: 1) A. Marshall & R. Peace, *JChemSoc* **109**, 298 (1916) 2) W.H. Rinkenbach, *IEC* **18**, 1195 (1926) 3) W.DeC. Crater, *JSocChemInd* **24**, 674 (1929) 3a) A. Marshall, *JSocChem-Ind* **49**, 34T (1930) 3b) H.W. Thompson & C.H. Purkis, *TransFaradSoc* **32**, 675 (1936) 4) J.D. Brandner, *JSocChemInd* **30**, 681 (1938) 4a) K. Stewart, *TransFaradSoc* **41**, 663 (1945) 5) A.J.B. Robertson, *TransFaradSoc* **44**, 977 (1948) 5a) A.J.C. Nicholson, *JChemSoc*, 1554 (1949) 6) G. Edwards, *TransFaradSoc* **46**, 423 (1950) 7) I. Nitta et al, *JChemSoc-Japan* **71**, 378 (1950) & *CA* **45**, 6448 (1951) 7a) H.O. Spauschuss & J.M. Scott, *JACS* **73**, 208 (1951) 8) G. Edwards, *TransFaradSoc* **48**, 513 (1952) 9) G. Edwards, *TransFaradSoc* **49**, 152 (1953) 10) M.D. Kemp et al, *JPhys-Chem* **61**, 240 (1957) 10a) B.L. Evans et al, *ChemRevs* **59**, 549 (1959) 10b) J. Vacek & J. Stanek, *ChemPrumsyl* **9**, 286 (1959) & *CA* **54**, 10436 (1960) 11) Yu.Ya. Maksimov, "Teoriya VV Sb Statei" (1963) & *CA* **59**, 12206 (1963) 11a) M.F. Zimmer et al, *JChemEng-Data* **9**, 527 (1964) 12) E.A. Miroshnichenko et al, *ZhFizKhim* **41**, 1477 (1967) & *CA* **67**, 85584 (1967) 13) V.I. Pepekin et al, *ZhFiz-Khim* **42** (11), 1583 (1968) 14) J.M. Rosen

& C. Dickinson, *JChem&EngData* **14** (1), 120 (1969) 15) F.T. Crimmins, *UCRL* **50704** (1969) 16) A.D. Coates et al, *BRL* **1507** (1970) 17) C. Lenchitz & R.W. Velicky, *JChemEngData* **15**, 401 (1970) 17a) J.D. Cox & G. Pilcher, "Thermodynamics of Organic & Metallorganic Compounds", Academic Press, NY (1970) 17b) Anon, *EngrgDesHndbk*, "Explosives Series, Properties of Explosives of Military Interest", *AMCP* **706-177** (1971) 17c) P.G. Hall, *TransFaradSoc* **67** (Pt 2), 556 (1971) 17d) R.H. Dinigar & M. Stammier, *Explosivst* (1971), 14 18) D.F. Covell, *NOLTR-74-136* (1975) (AD-A008141) 19) J.W. Taylor & R.S. Crookes, *JChemSoc, FaradTrans* **2**, 723 (1976) 20) P.A. Pella, *AnalChem* **48**, 1633 (1976) 21) P.A. Pella, *JChemThermodyn* **9**, 301 (1977) 22) D.C. Leggett, *JChromat* **133** (1977) 23) D.C. Leggett et al, *CRREL Rept* **77-16** (1977) (AD-040632) 24) R.B. Cundall et al, *JChemSoc, FaradTrans* **74**, 1339 (1978) 25) G.N. Roberts, "Proc Symp on Detection and Identification of Explosives", Reston, Va (Nov 1978), 475 26) Private communication with M.E. Hill on unpublished NBS data (1981)

Vapor Taggants for Explosives. See under "Tagging of Explosives" in Vol 9, T13-L ff

VARICOMP. A method for evaluating the interface between fuze expl components in which it can be determined by statistical analysis and testing that the reliability and safety of a fuze expl train can be predicted at high-confidence levels with a small number of tests. This is done by varying the sensitivity of different expls that are then substituted into the expl train of interest to determine the safety and reliability limits under a *penalty test* situation

In a penalty test, a property of the system is modified to reduce the probability of the desired result. For example, to predict safety, a particular expl train interface may be tested with a standard donor and a "more sensitive" acceptor; conversely, to predict reliability, a "less sensitive" acceptor material is used. If this probability is reduced sufficiently, it is possible to obtain mixed responses (that is, some fires and some no-fires) with samples of reasonable size, and to develop data from which the mean value of the penalty and its standard deviation (as well as confidence limits) can be established. These estimates can be used in statistical extrapolation to estimate safety or reliability under the original design conditions. The term **VARI-COMP** (**VARI**ation of explosive **COM**position) was coined by J.N. Ayres for a method developed at the Naval Ordnance Lab, White Oak, in the 1950's and early 1960's (Ref 1)

Under contract with the Naval Weapons Center, R. Stresau Laboratory, Inc, completed the sensitivity calibration of various design expls and two different series of VARICOMP expls (desensitized RDX) (Refs 2 to 7). The work differed from earlier similar efforts in that each expl was calibrated using donors of three diameters (50, 100 and 200 mils). One of the VARICOMP mixes has a sensitivity to initiation nearly independent of diameter; the other has a sensitivity to initiation highly dependent upon diameter. Reported upon are (1) RDX/Calcium Stearate binary series (the same as used in the original work), (2) RDX/Calcium soap series, (3) CH-6, (4) PBXN-5, Type I, (5) PBXN-5, Type II, (6) HNS-1A, and (7) PETN. Calibrations were based on 30-shot

Refs: 1) J.N. Ayres et al, "VARICOMP, a Method for Determining Detonation Transfer Probabilities", NAVWEPS Rept 7411, Naval Ordn Lab, White Oak, Md (1961) 2) R.H. Stresau, "Development of the VARICOMP Method, Expansion of Applicability (To Determine Detonation Transfer Probabilities with Reduced Dependence Upon System Variables). Part 1. Calibration and Characterization of PBXN-5 as Design Explosive", R. Stresau Laboratory, Inc, Spooner, Wis (27 Dec 1972) [Rept RSLR 72-7 for the Naval Weapons Center, China Lake, Calif] 3) Ibid, "Ibid. Part 3. Calibration of RDX/Calcium Stearate Binary System for Use as VARICOMP Surrogates", Ibid (14 Feb 1973) [Rept RSLR 73-1 for the Naval Weapons Center, China Lake, Calif] 4) Ibid, "Ibid. Part 5. Calibration of PETN for Use as a Surrogate for PBXN-5 in Safety Tests", Ibid (8 May 1973) [Rept RSLR 73-2 for the Naval Weapons Center, China Lake, Calif] 5) Ibid, "Ibid. Part 2. Formulation of VARICOMP Mixtures with Minimum Dependence of Sensitivity Upon Donor Diameter", Ibid (14 June 1973) [Rept RSLR 73-3 for the Naval Weapons Center, China Lake, Calif] 6) Ibid, "Ibid. Part 1(C). Calibration of CH-6 as a Design Explosive", Ibid (1974) [Rept RSLR 74-1 for the Naval Weapons Center, China Lake, Calif] 7) Ibid, "Ibid. Part 4. Preparation and Calibration of VARICOMP Mixtures with Minimum Dependence of Sensitivity upon Donor Diameter", Ibid (21 Jan 1974) [Rept RSLR 74-2 for the Naval Weapons Center, China Lake, Calif] 8) J.E. Means, "An Expanded Vari-comp Method for Determining Detonation Transfer Probabilities", Naval Weapons Center Rept NWC-TP-5789 (Dec 1975) (AD-A021890)

VE₄. See under "Italian Explosives and Related Items" in Vol 7, I181-R

Vegetable and Animal Fats and Oils, Nitrated. See under "Fats, Fatty Oils, Tallows, Butters, Waxes and Fatty Acids" in Vol 6, F8-L to F9-L

Végétale, Poudre (Fr). See under "Castan (Explosif de) or Poudre Végétale" in Vol 2, C83-R

Velocity, Detonation

Detonation velocity (also called detonation rate) is the speed at which detonation progresses thru an expl. Commonly it is designated by the symbol D , and it is usually understood to be a steady velocity, and not a transient velocity such as that observed in build-up to detonation or in overdriven detonations. The contents of this article are limited to steady "high-velocity" detonations. Detonation velocity is the most easily and most accurately measurable detonation parameter (other detonation parameters are detonation pressure, particle velocity, temp, etc). Consequently there exists a large body of exptl and theoretical literature on this subject. Much of this literature, up to about 1965, was summarized in Vol 4, pp D223–224, 232–235, 242–245, 280, 352, 356, 362, 384–389, 460–461, 463–464, 629–637, 641–652, 657–660, 663–675 and 718–721. The present article is a selected review of published information on detonation velocity from 1967 to date

Measurement Techniques

Methods of measuring detonation velocity fall into two categories: *Optical* and *electronic*. Modern methods are reviewed in Ref 8 and apparatus and techniques of optical measurements are presented in Vol 7, H104–112

A novel technique that utilizes Schlieren

interferometry of Doppler-shifted laser light (Argon-ion laser) is described in Ref 10. Although this technique is best adapted to measuring detonation or shocks in gaseous media, it can also be used in condensed media. A schematic representation of the method is shown in Fig 1, followed by a simplified description quoted from Ref 10

"The frequency ν' of a beam deflected through a small angle θ by a phase object moving with a velocity u at right angles to the incident beam of frequency ν is given by

$$\nu' = \nu \left(1 + \frac{u\theta}{c} \right) \quad (1)$$

where c is the velocity of light. The Doppler-shifted beam A and the reference beam B pass through the appropriate apertures in the Schlieren blind, become spread as a result of diffraction, and overlap one another at the detector. The photodetector responds to the beat frequency $\nu_b = \nu' - \nu$ produced by the interference of these two beams. The velocity of the object is then given by

$$u = \frac{\nu_b \lambda}{\theta} = \frac{\nu_b \lambda f}{b} \quad (2)$$

It is claimed that the error in D measured over distances as small as 0.1 to 0.2 cm is around $\pm 20\%$

Campos (Ref 23) examined a measurement technique that uses a resistive wire probe to

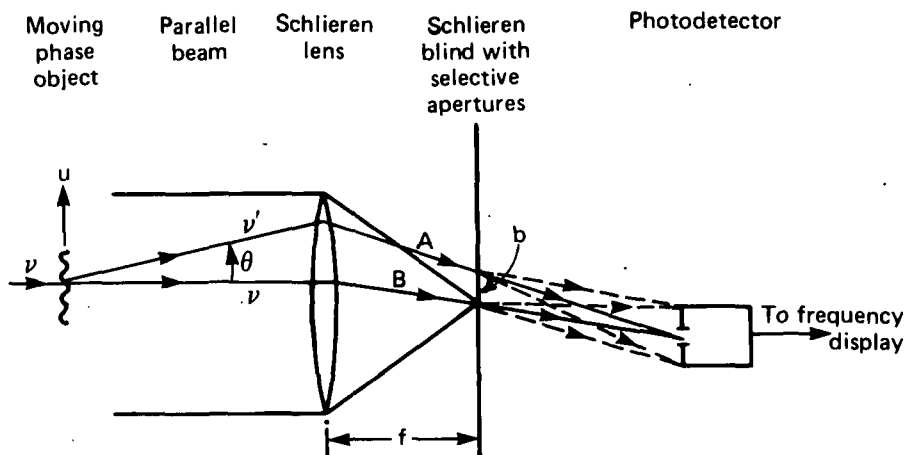
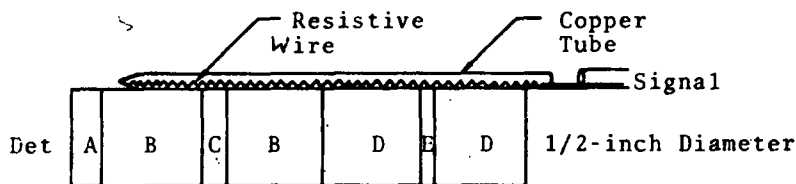

Fig 1 Optical arrangement for measuring the velocity of a moving phase object using Schlieren Interferometry of Doppler-shifted laser light. A is the Doppler-shifted beam, and B is the reference beam



Material: A = 12.7 mm PBX 9407 (used as booster)
 B = 38.1 mm TNT, $\rho = 1.63$ g/cc
 C = 10.16 mm LX-14, $\rho = 1.82$ g/cc
 D = 38.1 mm LX-14, $\rho = 1.82$ g/cc
 E = 3.05 mm Mück

(All pieces pressed in same direction)

Fig 2

obtain continuous records of detonation velocity. In this technique a partially insulated resistive wire is placed inside a thin-walled copper or brass tube. The arrangement used is sketched in Fig 2

The signal from this system is fed into a differentiating operational amplifier. According to Campos, D values obtained for TNT and LX-14 are about 10% larger than expected

Factors That Affect Detonation Velocity

Before presenting recent theoretical developments as well as actual data on detonation velocity, factors that affect D will be considered. Detonation velocity *does not* depend solely on the chemical compn of the expl. Indeed there are several factors that influence D more strongly than the chemical nature of the expl. Below we show a list of such factors, arranged in approximately descending order of influence:

1) Packing density (for solid expls); 2) Expl column diameter or confinement; 3) Chemical nature; 4) Particle size; 5) Binder content (in the 5 to 20% range; obviously a 20+% binder content can exert a very strong effect and could cause failure); 6) Strength of initiation (primarily in liq expls, where weak initiation can produce a quasi-stable "low velocity detonation"; in solid expls the strength of the initiator may affect run-up distance to stable detonation or even fail to initiate stable detonation)

Most of these factors interact. For example, in a "sensitive" expl such as PETN, column

diameter (or confinement), particle size and moderate binder content exert relatively little effect on D, whereas in an "insensitive" expl such as TNT, these factors can change D appreciably. The one factor that exerts a strong influence on D regardless of the chemical compn of the expl is *packing density*. Thus, for both PETN and TNT the variation in D from the lowest practicable packing density to near crystal density is more than two-fold

Theoretical Computation of Detonation Velocity

This subject was treated in Vol 4. However, since that time several new approaches have appeared. A recent equation of state (EOS) based on molecular interactions has been used to compute detonation parameters, including D. This so-called JCZ-3 EOS was briefly described in Vol 9, T212. Like most other EOS it leads to values of D in good agreement with exptl values of D in good agreement with exptl values (see Table I of Ref 19). Its virtue lies in that it uses no adjustable parameters to make the computations fit exptl data

A very recent development (Ref 27) is also based on an EOS obtained from considerations of intermolecular potentials of the detonation products. As in JCZ-3, detonation parameters are calcd without recourse to curve-fitting to exptl data. Agreement of computed and measured D is claimed to be within 2%

A useful semi-empirical approach was developed by Kamlet and Jacobs (Ref 2). Since

this approach is basically a simplification of the BKW EOS, detonation parameters computed by the Kamlet-Jacobs method are usually compared with parameters computed via the BKW EOS. For example, as far as computed D's are concerned, it is claimed that in some hundred cases agreement between Kamlet-Jacobs and BKW computations is to within 1%. Hardesty and Kennedy (Ref 19) have compared the Kamlet-Jacobs method with JCZ-3 and have also found good agreement. Additional comparisons between the BKW and Kamlet-Jacobs methods are made in Ref 11

The basic equations of the Kamlet-Jacobs method for CHNO expls with packing density $\rho_0 > 1$ are:

$$P = K\rho_0^2\phi,$$

$$\phi = NM^{1/2}Q^{1/2},$$

$$D = A\phi^{1/2}(1 + B\rho_0),$$

where:

- $K = 15.58,$
 $\rho_0 =$ initial density of HE [g/cm^3 (Mg/m^3)],
 $A = 1.01,$
 $B = 1.30,$
 $N =$ moles of gaseous detonation products per gram of HE (mol gas/g HE),
 $M =$ avg molecular weight of detonation product gas (g gas/mol gas),
 $Q =$ chemical energy of the detonation reaction (cal/g).

Values of N, M, and Q can be estimated from the $\text{H}_2\text{O}-\text{CO}_2$ decompn assumption:

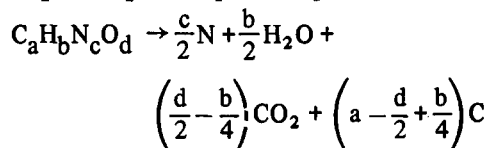

Table 1
Detonation Velocities of Explosives

Explosive	Formula	V, (g • atom)/g	OB, %	Q _v , kcal/kg	D _{1.60} , km/sec		
					calculation		Experiment
					formula (3)	RUBY program	
TNT	C ₇ H ₅ O ₆ N ₃	92.51	-74.00	44.05	7.03	6.867	6.97± 0.03
Tetryl	C ₇ H ₅ O ₈ N ₅	87.11	-47.39	-45.30	7.25	7.380	7.27± 0.02
Hexogen	C ₃ H ₆ O ₆ N ₆	94.59	-21.62	-90.59	8.03	8.033	8.01± 0.02
Octogen	C ₄ H ₈ O ₈ N ₈	94.59	-21.62	-84.90	8.03	—	8.08± 0.03
PETN	C ₅ H ₈ O ₁₂ N ₄	91.77	-10.13	379.75	7.86	7.825	7.78± 0.04
Trinitrobenzene	C ₆ H ₃ O ₆ N ₃	84.51	-56.34	-59.15	6.97	—	7.02± 0.03
Picric Acid	C ₆ H ₃ O ₇ N ₃	82.97	-45.41	208.73	6.94	7.050	7.01± 0.03
Trinitroaniline	C ₆ H ₄ O ₆ N ₄	87.71	-56.14	59.64	7.08	—	7.01± 0.04
Nitroglycerin	C ₃ H ₅ O ₉ N ₃	88.10	+ 3.52	369.60	7.80	—	7.74± 0.02
TNT/Hexogen 50/50	C _{22.18} H _{24.53} O _{26.73} N _{20.12} *	93.55	-47.82	-23.27	7.55	—	7.49± 0.03

*Arbitrary formula for 1 kg of mixt

Aizenshtadt (Ref 18) proposed a method of computing D based on the supposition that D , at a given density, can be expressed as a function of several parameters based on the chemical formula of the expl and its heat of formation. Thus for a density of 1.6g/cm^3 he obtains:

$$D_{1.60} = \sqrt{0.73V - 0.24|OB| - 0.0073Q_v} \quad (\text{km/sec}) \quad (3)$$

For an expl of the general form of $C_a H_b O_c N_d$,

$$v = a + b + c + d/u \cdot 10^3 \quad (\text{g} \cdot \text{atom/kg}),$$

$$|OB| = |16(c - 2a - b/2) / u \cdot 10^2| \quad (\%),$$

$$Q_v = -[\Delta H_f + 0.3(b+c+d)] / u \cdot 10^3 \quad (\text{kcal/kg}),$$

where ΔH_f is the standard enthalpy of formation of the explosive, with $T=298.15^\circ\text{K}$, kcal/mole; u is the molecular weight of the expl. Comparisons of Eq (3) with BKW calcns and with explt measurements are shown in Table 1 (from Ref 18)

Aizenshtadt also claims that for the usual dependence of D on initial density ρ_0 ($D_{\rho_0} = D_{1.60} + M(\rho_0 - 1.60)$) that $M = 4.00 \pm 0.25$ for $c \geq 2a + b/2$, $M = 3.50 \pm 0.25$, for $a + b/2 < c < 2a + b/2$, and $M = 3.00 \pm 0.25$ for $3(c < a + b/2)$

Borzykh & Kondrikov (Ref 22) developed a generalized dependence of D on ρ_0 (ρ_{00} in their notation). Starting with the usual relation

$$D = A + B\rho_{00}, \quad (4)$$

where D is the detonation rate; ρ_{00} is the charge density; and A & B are empirical constants; and introducing D_0 , the detonation rate for the given material at the *maximum density* ρ_0 attainable under ordinary conditions (the density of a perfect crystal or of a liquid in the absence of gaseous inclusions), Eq (4) may be brought to a dimensionless form suitable for the comparison of different expls

$$R = 1 - \alpha m, \quad (5)$$

where $R = D/D_0$ is the relative detonation rate; $m = (\rho_0 - \rho_{00}) / \rho_0$ is the porosity of the charge; $\alpha = B\rho_0/D_0$. The degree of compression of the expl can be characterized not only by the density but also by a dimensionless quantity called the relative charge density,

$$\delta = \rho_{00}/\rho_0 = 1 - m.$$

In terms of δ , Eq (5) takes the form

$$R = \alpha_1 + \alpha\delta, \quad (6)$$

where $\alpha_1 = 1 - \alpha$. Finally, setting $1 - R = (D_0 - D) / D_0 = F$, it is found that F is proportional to the porosity:

$$F = \alpha m \quad (7)$$

For pure expls they find that an average $\alpha = 0.74 \pm 0.02$. Thus $(D_0 - D) / D_0 \cong 0.74m$ and there is a direct relationship between D and porosity m . For expl mixts (Comp B, Octol, etc) α varies and is not a constant as for pure expls. The "average" α for mixts is about 0.68

Detonation Velocity Data

A compilation of recent detonation velocity data taking into account $D - \rho_0$ and D -Diameter effects is shown in Table 2, taken from Ref 25

Recently published detonation velocity data on other expls is summarized below.

Bolkhovitinov & Viktorov (Ref 16) present diameter effect data for a number of expls including Soviet commercial expls, as shown in Table 3. (Note: *Trotyl* is TNT.) D_{id} is D at infinite diameter d . The "calculated" (method of calcn not given) reaction zone width is a and the "observed" reaction zone width is a_0 ; δ is "mean square" (sic) deviation *presumably* of a . In column 8 are the highest observed values of D divided by the diameter of the charge

Lederman et al (Ref 20) studied the detonation behavior of AMATEX-30, nominally 40/30/30 TNT/RDX/AN, at an average density of 1.645g/cc . Their results of the diameter effect (in terms of R , the charge radius) are summarized in Fig 2. Detonation failed to propagate in column diameters of 10mm. As shown, the infinite diameter D is 7.318km/sec , as compared to 7.031km/sec for Amatex 20 (40/20/40 TNT/RDX/AN). They also examined the effect of AN particle size on D . Their results for Amatex 20 are shown in Table 4

Engelke (Ref 24) states that there is a qualitative difference in the diameter effect curves of homogeneous and heterogeneous expls. From his observations on the behavior of neat NM (homogeneous) and admixtures of NM and silica (heterogeneous) he ascribes this difference to absence of *hot spots* in the former and their presence in the latter. The different behavior of homogeneous and heterogeneous expls (curved vs linear) is shown in Fig 3. It should be noted that...

Table 2
Detonation Velocity Equations

Explosive	Equation ^a	Condition
AP	$D = 1.146 + 2.576\rho$ $D = -0.45 + 4.19\rho$	$0.55 \leq \rho \leq 1.0$ $1.0 \leq \rho \leq 1.26$
Baratol	$D = 4.96 - (0.454/R)$	27% TNT, $\rho \sim 2.60$, $2.5 < R < 10$
Boracitol	$D = 5.15 - (6.25/R)$	$R > 5$ (0.05)
BTF	$D = 4.265 + 2.27\rho$	--
Comp B, Grade A	$D = 7.99 - [(75.6 \times 10^{-3})/R]$ $\Delta D/\Delta T = -0.5 \times 10^{-3}$	$\rho = 1.715$
Cyclotol 75/25	$D = 8.298 - [(57.7 \times 10^{-3})/R]$	77% RDX, $\rho = 1.755$
DATB	$D = 7.52 - [(52.76 \times 10^{-3})/R]$ $D = 2.495 + 2.834\rho$	$\rho = 1.788$ --
HBX-1	$D_{\infty} = -0.063 + 4.305\rho$	--
HNAB	$D = 18.579\rho - 5.233\rho^2 - 9.033$	$1.40 < \rho < 1.65$
LX-01-0	$\Delta D/\Delta T = -3.8 \times 10^{-3}$	--
LX-02	$D = 7.44 - [(4.31 \times 10^{-3})/R]$	Brass confinement; varies with confinement
LX-04-1	$D = 1.733 + 3.62\rho$ $D_{\infty} = 8.46 - [(24.015 \times 10^{-3})/R]$ $\Delta D/\Delta T = -1.55 \times 10^{-3}$ $\Delta D/\Delta W = -38 \times 10^{-3}$	-- $\rho = 1.86$ -54 to 74°C (219-347°K) (W = wt% Viron)
LX-07	$\Delta D/\Delta T = -1.55 \times 10^{-3}$ $\Delta D/\Delta W = -35 \times 10^{-3}$	-54 to 74°C (219-347°K) (W = wt% HMX)
LX-08	$\Delta D/\Delta T = -3.56 \times 10^{-3}$	-36 to 23°C (237-296°K)
LX-09	$\Delta D/\Delta T = -3.31 \times 10^{-3}$	-54 to 74°C (219-347°K)

(continued)

Table 2 (continuation)

Explosive	Equation ^a	Condition
LX-13 (See XTX-8003)		
NM	$\Delta D/\Delta T = -3.7 \times 10^{-3}$	-20 to 70°C (253–343°K)
	$D = 6.268 - [(4.23 \times 10^{-3})(T - T_0)]$	--
	$\Delta D/\Delta P = 0.197 \times 10^{-3} \text{ mm}/\mu\text{s-atm}$	(19.96 km/s-Pa)
NQ	$D = 1.44 + 4.015\rho$	$0.4 \leq \rho \leq 1.63$
	$D = 8.48 - [(64.97 \times 10^{-3})/R]$	77% HMX, $\rho = 1.814$
Octol 75/26	$D = 2.843 + 3.1\rho$	--
	$D = 8.371 - [(10.16 \times 10^{-3})/R]$	$\rho = 1.781$
PBX-9010	$D = 2.41 + 3.44\rho$	--
	$D = 4.995 + (36.54 \times 10^{-3}V)$	(V = vol% RDX; $\rho = 97.5\%$ TMD)
PBX-9205	$D = 8.8 - [(24.12 \times 10^{-3})/R]$	--
	$D = 2.176 + 3.6\rho$	--
PBX-9404	$\Delta D/\Delta T = -1.165 \times 10^{-3}$	-54 to 74°C (219–347°K)
	$\Delta D/\Delta T = -0.4 \times 10^{-3}$	--
Pentolite 50/50	$D = 2.14 + 2.84\rho$	$\rho < 0.37$
PETN	$D = 3.19 + 3.7(\rho - 0.37)$	$0.37 < \rho < 1.65$
	$D = 7.92 + 3.05(\rho - 1.65)$	$\rho > 1.65$
Picric Acid	$D = 4.880 + 3.560(\rho - 0.8)$	$\rho = 0.4, 0.6$
	$D = 5.255 + 3.045(\rho - 1)$	--
RDX	$D = 2.56 + 3.47\rho$	$\rho > 1.0$
TATB	$D = 0.343 + 3.94\rho$	$\rho > 1.2$
	$D = 7.79 - [(16.8 \times 10^{-3})/R]$	$\rho = 1.876$

(continued)

Table 2 (continuation)

Explosive	Equation ^a	Condition
TNT	$D = 4.340 + 2.830(\rho - 0.8)$	--
	$D_{\infty} = 1.873 + 3.187\rho$	(1.873 + (3.187 x 10 ⁻³ ρ))
	$D_{\infty} = 6.763 + 3.187(\rho - 1.534)$ $-25.1(\rho - 1.534)^2$ $+ 115.1(\rho - 1.534)^3$	--
	$D_{\infty} = 1.67 + 3.342\rho$	(1.67 + (3.34 x 10 ⁻³ ρ))
XTX-8003	$D = 7.26 - [(3.02 \times 10^{-3})/R]$	--
	$D = 3.68 + (44.8 \times 10^{-3}W)$	--
	$\Delta D/\Delta T = -2.34 \times 10^{-3}$	--

^aSymbols and units are: D = detonation velocity in mm/μsec (km/s), ρ = density in g/cm³ (Mg/m³), R = charge radius in cm (m), W = composition in wt%. V = composition in vol%, T = temperature in °C (K). Values or equations in parentheses are in SI units. See Ref 25 for the compn of the LX, PBX & XTX mixts; NG is nitroguanidine

Table 3
Diameter Effect Data (from Ref 16)

Explosive	ρ_0 , g/cm ³	D_{id} , m/sec	a, mm	$\frac{2a}{d_{cr}}$	δ	$\frac{a_0}{d}$	$\frac{D}{d}$
1	2	3	4	5	6	7	8
Cast Trotyl	1.62	7110	1.111	0.139	0.0047	$\frac{1.27}{60}$	$\frac{6980}{60}$
Cast Trotyl (another sort of casting)	1.6	7126	2.087	0.152	0.0104	$\frac{1.43}{60}$	$\frac{6850}{60}$
Ground Trotyl (0.1mm particle size)	1	5141	1.416		0.0021	$\frac{1.33}{100}$	$\frac{5130}{120}$
Flaked Trotyl (0.5mm)	1	5177	3.195		0.079	$\frac{1.63}{100}$	$\frac{5080}{100}$
Trotyl (84% 0.5mm, 16% 0.1mm)	0.95	5207	2.151	0.191	0.0215	$\frac{1.91}{60}$	$\frac{5000}{60}$
Trotyl NB (0.43mm)	1	5664	3.879	0.235	0.0101	$\frac{3.38}{100}$	$\frac{5450}{100}$
Hexogen	1	6326	1.952		0.0183	$\frac{2.5}{40}$	$\frac{6000}{40}$
Ammonium nitrate ZhV (0.2mm)	0.9	2986	10.135	0.338	0.0182	$\frac{4.97}{130}$	$\frac{2520}{130}$
TNT/Hexogen-40	0.5	3888	1.207	0.274	0.0312	—	$\frac{3850}{28.8}$
Picric Acid	0.9	5225	1.128	0.434	0.0500	—	$\frac{4900}{32.6}$
TNT/Hexogen-40	0.9	5329	0.665	0.277	0.0251	—	$\frac{5350}{28.4}$
Hexogen	0.9	5577	0.364	0.140	0.0200	—	$\frac{5500}{10.2}$
TNT/Hexogen-35	1.71	8090	0.308	0.154	0.0158	—	$\frac{8000}{21.8}$
Excavated Ammonite No 1	0.95	4888	2.349	0.313	0.0378	$\frac{2.51}{100}$	$\frac{4940}{100}$
Ammonite VA-4	0.92	4416	2.858	0.381	0.0396	$\frac{2.53}{100}$	$\frac{4450}{100}$
Ammonite 6ZhV	1.7	5513	3.102	0.310	0.0061	$\frac{2.36}{100}$	$\frac{5490}{150}$
Ammonite 6ZhV	1.45	5575	5.038	0.336	0.0321	$\frac{4.7}{100}$	$\frac{5400}{150}$
Ammonite 6ZhV	1.00	4740	3.794	0.379	0.0102	$\frac{2}{100}$	$\frac{4600}{100}$

(continued)

Table 3 (continuation)

Explosive 1	ρ_0 , g/cm ³ 2	D_{id} , m/sec 3	a, mm 4	$\frac{2a}{d_{cr}}$ 5	δ 6	$\frac{a_0}{d}$ 7	$\frac{D}{d}$ 8
Ammonite 6ZhV (prepared by different technology)	1.00	4759	2.320	0.232	0.0025	$\frac{1.58}{100}$	$\frac{4720}{120}$
Ammonite PZhV-20	1.00	4569	3.318	0.255	0.0151	—	$\frac{4540}{120}$
"Zernogranulite" 80/20	1.00	4297	13.574	0.2262	0.0387	$\frac{3.42}{130}$	$\frac{4080}{300}$
"ifzanite" T-60	1.50	5800	17.764	0.237	0.0628	—	$\frac{5660}{400}$
Tritonal 80/20	1.00	3905	2.02	0.270	0.015	—	$\frac{3900}{80}$
Hexogen/TNT/Al 45/30/25	1.15	4649	1.18	0.118	0.003	—	$\frac{4600}{100}$
Tritonal 80/20	1.75	6820	1.85	0.123	0.003	—	$\frac{6700}{150}$
Composition V-AS	1.59	7591	1.11	0.111	0.004	—	$\frac{7550}{100}$
Ammatol 50/50	1.53	6650	5.28	0.264	0.022	—	$\frac{6400}{200}$
Sodatol 50/50	1.83	6056	3.087	0.154	0.005	—	$\frac{6000}{200}$
TNT (-4+6)	1.00	5273	6.112	0.245	0.031	—	$\frac{5000}{170}$
DNT (-65+100)	0.95	3939	7.933	0.317	0.013	—	$\frac{3900}{200}$

Table 4
Collection of Amatex Detonation Velocities (from Ref 20)

Shot No	Explosive	Diam (mm)	Detonation Velocity (mm/ μ sec)	Density (Mg/m ³)	Confinement (mm OFHC copper) $\rho = 8.920\text{Mg/m}^3$	Detonation Velocity Corrected to $\rho = 1.615\text{Mg/m}^3$
E-3983	Amatex/20 GR/C	17.0	6.030	1.614	None	6.033
E-3817	Amatex/20 GR/C	25.4	6.542 \pm 0.001	1.616	None	6.539
E-3819	Amatex/20 GR/C	50.8	6.833 \pm 0.001	1.611	None	6.845
E-3823	Amatex/20 GR/C	101.6	6.937 \pm 0.002	1.613	None	6.943
E-3999	Amatex/20 GR/P	25.4	6.804 \pm 0.001	1.620	None	6.789
E-3998	Amatex/20 GR/P	50.8	6.845 \pm 0.003	1.615	None	6.845
E-4007	Amatex/20 SF/P	25.4	6.905 \pm 0.002	1.620	None	6.890
E-4006	Amatex/20 SF/P	50.8	7.023 \pm 0.001	1.613	None	7.029
E-4033	Amatex/20 PR/C	25.4	6.143 \pm 0.006	1.627	None	6.107
E-4034	Amatex/20 PR/C	50.8	6.766 \pm 0.003	1.628	None	6.727
C-4317	Amatex/20 GR/C	50.8	6.857 \pm 0.002	1.613	5.20	6.863
C-4321	Amatex/20 GR/C	101.0	6.951 \pm 0.001	1.613	10.35	6.957
C-4397	Amatex/20 PR/C	101.0	6.805 \pm 0.003	1.572	10.35	6.934
C-4389	Amatex/40 GR/C	101.0	7.510 \pm 0.001	1.652	10.35	7.399
C-4374	Composition B Grade A/C	101.0	7.915 \pm 0.002	1.701	10.35	7.657
C-4430	Composition B Grade A/C	25.4	7.867 \pm 0.007	1.696	2.60	7.624
C-4432	Amatex/20 GR/C	25.4	6.810 \pm 0.004	1.601	2.60	6.852
C-4433	Amatex/20 SF/P	25.4	6.941 \pm 0.004	1.618	2.50	6.932

PR is Prilled ammonium nitrate (AN) with mean particle size of approximately 2000 μ m

GR is Ground AN with mean particle size of approximately 500 μ m

SF is Superfine AN with mean particle size of approximately 10 μ m

C is Cast

P is Pressed

confinement has essentially no effect on the variation of D with R for NM. Fig 4 compares neat NM with NM containing silica. Note the great similarity of the latter curve with that of PBX-9404 shown in Fig 3

Additional data on density and diameter effects is provided by Kegler (Ref 4) for RDX/TNT and HMX/TNT mixts. Fig 5 shows the variation of D (V_D in Kegler's notation) with initial density ρ with charge diameter ϕ as a parameter. Fig 6 shows the variation of D with $1/\phi$ (Eyring plot) with initial density as a parameter. Also shown are reaction zone widths as computed by the Eyring method

That ambient temp or pressure have little influence on D was shown by O'Barr & Campbell

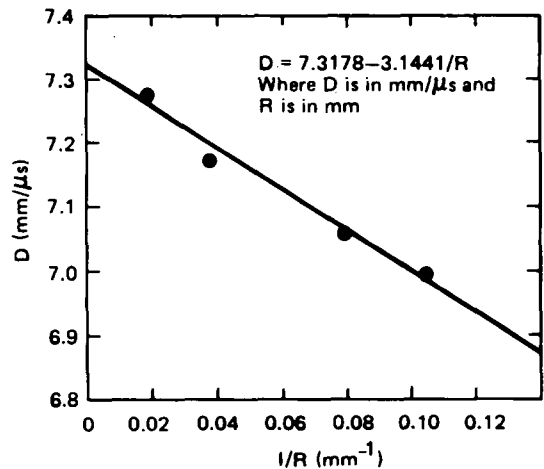

Fig 2 Diameter Effect Results for Amatex/30

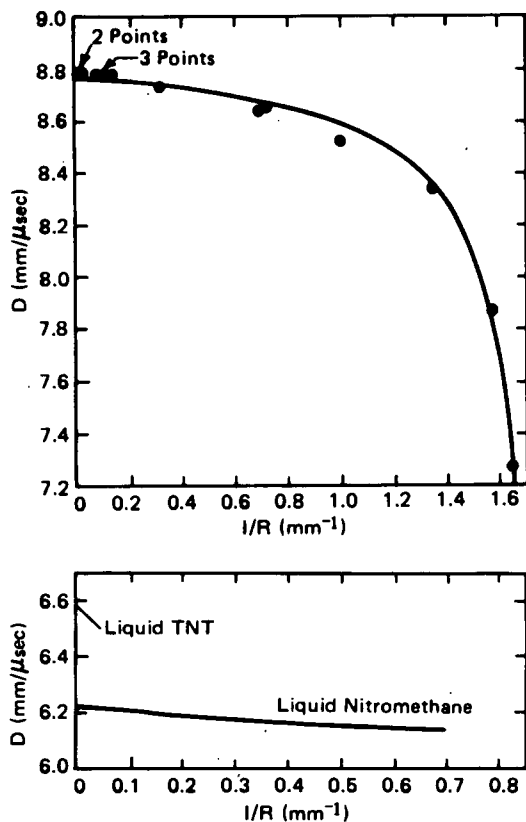

Fig 3 The upper diameter-effect curve is for unconfined PBX-9404; $\rho = 1.846\text{g/cm}^3$ (99.0% theoretical maximum density). The failure point is at $1/R = 1.69 \pm 0.03\text{ mm}^{-1}$. The lower diameter-effect curves are for liquid TNT ($\rho = 1.443\text{g/cm}^3$) confined in 2.54-mm-thick Pyrex and liquid NM ($\rho = 1.128\text{g/cm}^3$) confined in 3.18-mm-thick brass. The 31 (at four diameters) liquid TNT data points all lie within $0.0004\text{mm}/\mu\text{sec}$ of the fit. The nine (at five diameters) NM points all lie within $0.002\text{mm}/\mu\text{sec}$ of the fit. The failure points for TNT and NM are at $1/R = 0.032 \pm 0.001$ and $0.70 \pm 0.10\text{ mm}^{-1}$, respectively

(Ref 1) and Brochet et al (Ref 3) respectively. O'Barr & Campbell found that for 2gr/ft PETN MDF (mild detonating fuse) there was no detectable change in D from room temp to -400°F . For 7gr/ft PETN and 15gr/ft RDX linear shaped

charges they observed a decrease in D of only 3–5% over the same temp range

Brochet et al (Ref 3) studied the effect of ambient pressure on the detonation velocity of NM. Their measurements, corrected to an ambient temp of 277°K , provide a pressure coefficient of D of 0.197M/s/kbar . Thus at an ambient pressure of 1 kbar the increase in D (ca 6300m/sec at 1 bar) is only 197m/sec

Andersen et al (Ref 6) obtained about the same pressure coefficient of D for NM as Brochet et al. However, theoretical considerations predict that this coefficient should decrease at higher ambient pressure. This predicted decrease was not observed. Indeed for NM and a solid aluminized expl, HBX, D increased with ambient pressure in essentially the same manner as it would increase with increasing initial density of the expl due to compression by the ambient pressure. Since the compressibility of liq expls and solid expls at near crystal density is relatively low at moderate ambient pressures, the rather small effect of ambient pressure on D is understandable

Although LVD (low velocity detonation) is not the subject of this present article, we mention in passing some interesting observations of Kusakabe & Fujiwara on LVD in Methylnitrate (Ref 7)

Austing et al (Ref 5) and Tullis and Austing (Ref 12) studied the detonation properties of very low density expls ($0.25\text{g/cm}^3 \leq \rho_0$). PETN, NC and NC/NG were uniformly dispersed in polyurethane foams to achieve their low densities. A few measurements were also made on unfoamed Nitroguanidine. Selected values of D for foamed PETN are shown in Table 5

Table 5
Detonation Velocity of Foamed PETN *

ρ_0 (g/cm ³)	D (km/sec)
0.176	2.45 (?)
0.133	1.17
0.120	1.14
0.12	1.0 *
0.109	1.12
0.094	0.98
0.055	0.78
0.049	0.59

* From Ref 12; all others from Ref 5

I TNT: HMX 35:65

II TNT: RDX 35:65

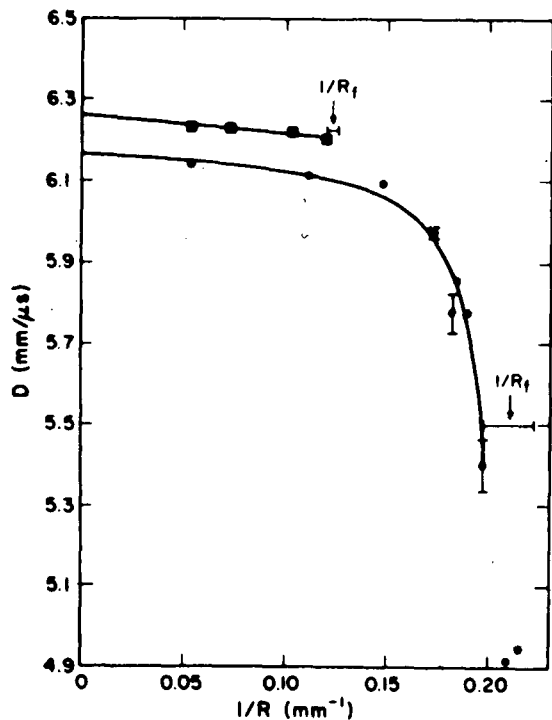

Fig 4 NM and 92.75/6./1.25 wt% NM/silica/guar diameter-effect curves. The squares and circles superimposed on the curves are the data from Tables II and III. On the latter curve the point marked with an asterisk at $1/R=0.21\text{mm}^{-1}$ was failing. The NM and gelled material have failure points at $1/R$ equal to 0.123 ± 0.003 and $0.209 \pm 0.012\text{mm}^{-1}$, respectively. Here the error bars are obtained from one-half the difference of the internal diameters of the largest stick which failed and the smallest stick which propagated

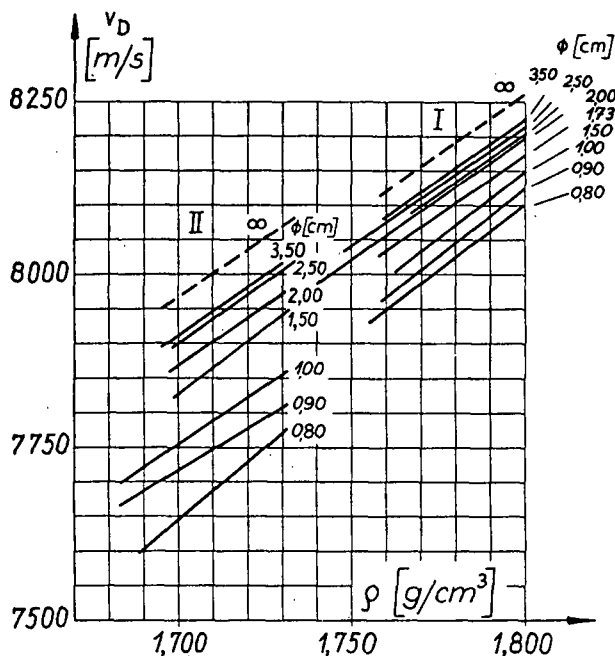

Fig 5

TNT: HMX 35:65, $\rho = 1,798$ et $1,770 \text{ g/cm}^3$

TNT: RDX 35:65, $\rho = 1,730$ et $1,708 \text{ g/cm}^3$

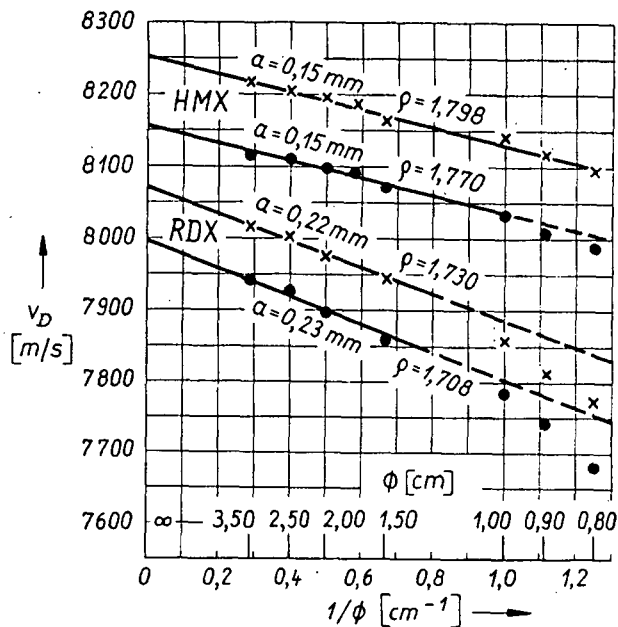

Fig 6

Taken at face value, their results indicate that the $D-\rho_0$ plot for foamed PETN has a sigmoid shape

Foamed NG/NC mixts gave inconsistent results. It seems that there is little variation in D for their mixts over a 0.06 to 0.12g/cm³ range in initial density (Ref 5). The detonation velocity of an unfoamed mixt at around 0.2 g/cm³ was about 2.6–2.7km/sec

For unfoamed NC, results were again irreproducible. Values of D ranged randomly from 1.9 to 2.5km/sec over a density range of 0.10–0.25 g/cm³ (Ref 5). For Nitroguanidine at 0.195 g/cm³ the measured D was 2.7km/sec (Ref 12)

We now present a brief overview of recent publications on detonation velocity of specific expls or expl mixts

Fujiwara et al (Ref 13) studied urea mono-perchlorate, —UP— CO(NH₂).HClO₄. It is readily soluble in water and this soln can then dissolve organic material to form expl mixts. Fig 7 shows the density and D of a 90% UP soln (UPS) containing various amounts of NM. Note that D of NM is increased appreciably

Ramsay & Chiles (Ref 14) initiated liq NO contained in a steel tube with a P-16 plane-wave generator. They obtained an average D of 5.62km/sec. Steady detonation was observed within 26mm for the plane wave generator. BKW calcns give $D = 5.61$ km/sec in excellent agreement with measurements

Several commercial expls, primarily slurries (see Vol 9, S121–147) were examined by Finger et al (Ref 15). Their measurements for ANFO (94.2/5.8 AN/Fuel Oil) are shown in Table 6

Table 6

Dependence of D on Charge Diameter of ANFO

Density (g/cm ³)	Diameter (mm)	D (km/sec)
0.80	51	3.25
0.78	102	3.89
0.84	292	4.56
0.82	292	4.55
109 tons!		4.74

The highest observed detonation velocities for the slurry expls are shown in Table 7

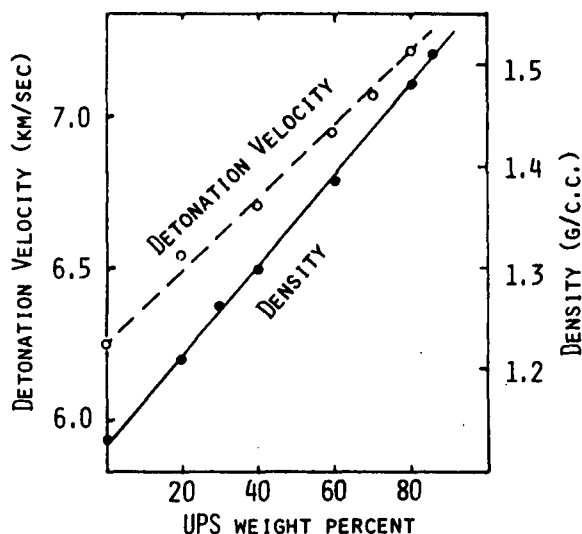

Fig 7 Detonation Velocity and Density (20°) of NM-UPS Mixture

Table 7
Detonation Velocity of Slurry Explosives

Explosive	Density (g/cm ³)	D (km/sec)
Unigel (Hercules)	1.26	5.76
Teledet (Teledyne)	1.36	6.52
Pourvex (Dupont)	1.36	6.33
Aqualan (Atlas)	1.43	3.73
El-836 (Dupont)	1.52	5.79
DBA-65-T2 (Ireco)	1.52	5.40

Akhimova & Stresik (Ref 17) studied the detonation characteristics of Ammonium Perchlorate (AP) mixed with various "fuels". They were primarily interested in the failure diameter (critical diameter) of these mixts, but they do report some detonation velocity measurements at the critical diameter of the mixts

It is well known that addition of Al (even in finely divided form) to organic high expls lowers their D . How this lowering is caused was not understood until fairly recently. A careful study of this problem was undertaken by Price (Ref 9). Her conclusions are as follows:

"1) In all probability, the aluminum does not react in the detonation front but sometime later.

2) Al as a diluent lowers D . The lowering is a linear function of the volume fraction of Al present; it also depends on the density and com-

pressibility of Al as well as on its particle size and shape — probably on the total surface and heat conductivity.

3) The lowering of D by dilution with Al also depends on the particular H.E. used. The same amount and form of Al has a larger effect (expressed as %D) on explosives of initially higher D values. Thus the effect decreases in the order RDX, TNETB, TNT.

4) Aluminum as a diluent lowers P.

5) The decrease in D and P is most obvious at high porosity (low Δ) and high Al content; the former is the more important factor.

(P is detonation pressure and

$$\Delta = \rho_0/\rho_v = 1 - y_a$$

$$\rho_v = \left(\frac{\text{Solids}}{\sum_i x_i/\rho_i} \right)^{-1}$$

where y_a = volume fraction of air in the mixt)²

Chaudri et al (Ref 21) claim to have observed an unexpectedly high detonation velocity of about 8km/sec for single crystals of α -lead azide of 2 x 2mm cross-section. They used a framing camera at a framing rate of $5 \times 10^6 \text{ sec}^{-1}$ for their measurements. Frequently it is difficult to obtain reliable quantitative data by this method

Very recently there has developed an interest in the detonation behavior of eutectic mixts containing Ammonium Nitrate (AN). Stinecipher (Ref 30) studied eutectics of AN/ADNT as well as AN/ADNT/org HE (ADNT is the ammonium salt of 3,5-Dinitro-1,2,4 Triazole).

At $\rho_0 = 1.58 \text{ g/cm}^3$, ADNT has a D = 7.87km/sec. Selected D data for the eutectics are shown below (NQ is Nitroguanidine):

Eutectic (mole ratios)	Density (g/cm ³)	D (km/sec)
2/1 AN/ADNT	1.64	7.89
1.38/1/1.5 AN/ADNT/RDX	1.72	8.46
5/1/1 AN/ADNT/RDX	1.70	7.71
2/1/1.3 AN/ADNT/TATB	1.77	7.85
1.38/1/1.83 AN/ADNT/NQ	1.65	8.16

An alternate eutectic system was examined by Akst (Ref 26). This consisted of a 50/50 mixt of Ethylenediamine Dinitrate (EDD) with AN (EA) as is, and mixed with RDX. Selected values of D for these mixts are shown below:

Composition (wt %)	Density (g/cm ³)	D (km/sec)
EDD	1.58	7.3 (a)
EA	1.57	5.6 (a)
EA	1.57	6.4 (b)
42.5/42.5/15 EDD/AN/RDX	1.60	7.1 (b)

a) Confined at a diam of 12.7mm

b) Confined at a diam of 25.4mm

Campbell et al (Ref 29) measured D as a function of charge diam for a number of TATB/HMX/binder combinations shown in Table 8

Table 8
Compositions of TATB/HMX Explosives

Material	TATB	HMX %	Kel-F 800	Theoretical Max Density (g/cm ³)
PBX 9502	95	0	5	1.942
X-0341	90.25	4.75	5	1.940
X-0342	85.5	9.5	5	1.938
X-0343	80.75	14.25	5	1.937
X-0344	71.25	23.75	5	1.933
X-0321	75	20	5	1.934
X-0320	60	35	5	1.928
X-0319	50	45	5	1.925
PBX 9501	0	95	5 ^a	1.855

^a Binder is 2.5 wt % Estane/2.5 wt % nitroplasticizer rather than Kel-F 800

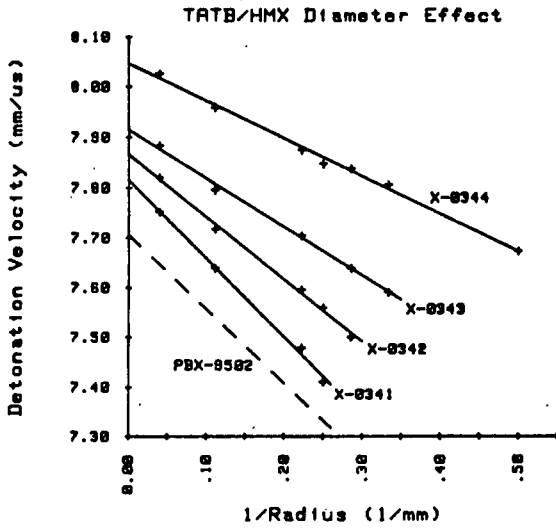

Fig 8 Detonation Velocities of TATB-HMX Mixtures

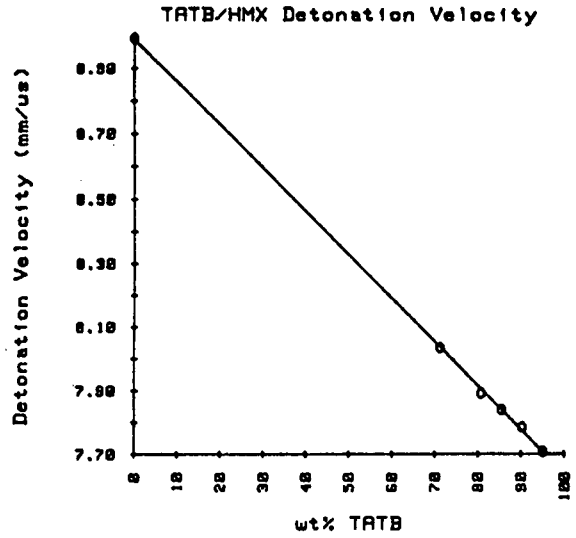

Fig 9 Infinite Diameter Detonation Velocities of TATB-HMX Mixtures

Table 9
Detonation Properties of Five Compositions Having Different Inert Binders

No	Binder Centesimal Atomic Composition (%)					Binder Density	Detonation Velocity, D (m/s)	Critical Diameter, ϕ Cr (mm)
	C	H	O	N	Si			
1	37.4	58.2	4.4	-	-	0.945	7818 $\sigma = 48$	4.2 ± 0.2
2	38.4	58.9	1.8	0.9	-	0.951	7836 $\sigma = 9$	4.0 ± 0.3
3	33.4	60.2	5.5	0.9	-	0.968	7930 $\sigma = 20$	3.0 ± 0.2
4	30.4	58.8	9.9	0.9	-	1.036	7929 $\sigma = 24$	3.0 ± 0.2
5	14.2	28.6	28.6	-	28.6	1.022	7483 $\sigma = 16$	4.5 ± 0.2

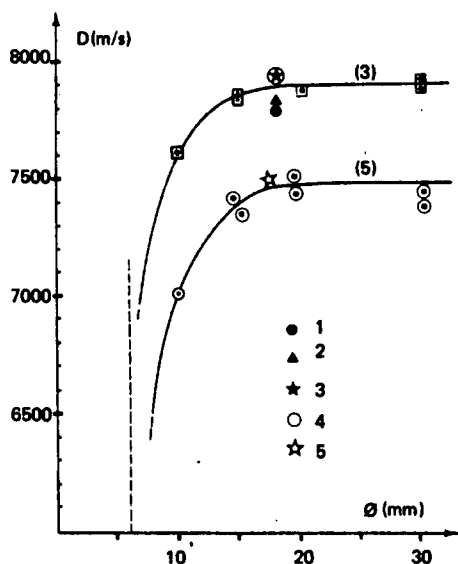

Fig 10 Binder Effect on Detonation Velocities
(Numbers are related to Table 9)

Their $D \times 1/d$ plots are shown in Fig 8, and D at infinite diam as a function of TATB content in Fig 9. Note that in Fig 8 the compns with the highest amounts of HMX have the shallowest slopes. The compn with only 4.75% HMX (X-0341) has essentially the same slope as the TATB-binder mixt

De Longueville et al (Ref 28) also examined the interaction effects of binder content and charge diameter. The test material in each case was 72% by volume of a fixed particle size RDX with 5 different binders. Max values of D are shown in Table 9, and D vs $1/d$ plots for mixts 3 and 5 of Table 9 are given in Fig 10. Note that Si content in the binder reduces D

Based on the above, as well as data on PETN/polyurethane compns, a tentative model of binder-expl reaction is presented, which ascribes some reaction to the CJ state, and additional reaction in the Taylor wave

Written by J. ROTH

Refs: 1) G.L. O'Barr & M.D. Campbell, *Advan-CryogEng* 12, 690 (1967) 2) M.J. Kamlet & S.J. Jacobs, *JChemPhys* 48, 23 (1968) 3) C. Brochet et al, *CRAcadSci (Paris), Ser B* 269, 105 (1969) 4) W. Kegler, *ChimIndGenie-Chim* 103, 1549 (1970) 5) J.L. Austing et al, 5th Symp Deton (1970), 47 6) W.H. Anderson et al, *Ibid*, 67 7) M. Kusakabe & S. Fujiwara, *Ibid*, 267 8) Anon, *Engrg Des Hndbk*, "Principles of Explosive Behavior", AMCP 706-180 (1972), 5-1 to 5-4 9) D. Price, *NOLTR* 72-62 (1972) 10) M.J.R. Schwar & J.R. Bowen, *JPhysDapplPhys* 5, 1561 (1972) 11) P.E. Rouse, *JChemEngData* 21, 16 (1976) 12) A.J. Tullis & J.L. Austing, 6th Symp Deton (1976), 183 13) S. Fujiwara et al, *Ibid*, 450 14) J.B. Ramsay & W.C. Chiles, *Ibid*, 723 15) M. Finger et al, *Ibid*, 729 16) L.G. Bolkhovitinov & S.D. Viktorov, *FizGoreniyaVzryva* 12, 799 (1976) 17) L. Akhimova & L.N. Stresik, *Ibid*, 247 18) I.N. Aizenshtadt, *Ibid*, 754 19) D.R. Hardesty & J.E. Kennedy, *Combstn&Flame* 28, 45 (1977) 21) M.M. Chaudri et al, *Proplnts&Expls* 2, 91 (1977) 22) M.N. Borzykh & B.N. Kondrikov, *FizGoreniyaVzryva* 14, 117 (1978) 23) C.A. Compos, *ProcDevEndeavor* No 231, Mason & Hanger Rept (1978) 24) R. Engelke, *Phys-Fluids* 22, 1623 (1979) 25) B.M. Dobratz, "LLNL Explosives Handbook—Properties of Chemical Explosives and Explosive Simulants", UCRL-52997, Lawrence Livermore Lab, Livermore, Ca (1981) 26) I.B. Akst, 7th Symp Deton (Preprint) (1981), 292 27) R. Chirat & G. Pittion-Rossillon, *Ibid*, 360 28) Y. de Longueville et al, *Ibid*, 657 29) A.W. Campbell et al, *Ibid*, 663 30) M. Stinecipher, *Ibid*, 733

Velocity of Explosively Driven Fragments

I. Introduction

One of the major practical uses of expls arises from their ability to create and propel fragments. Such fragments can be parts of a bomb casing in military applications or broken rock in industrial mining operations. In both instances the *velocity* of the fragments is important. It determines (to a large degree) the destructiveness of the former and the distance of throw of the latter. Consequently a reliable method of predicting fragment velocity of explosively-propelled material is of great value for both military and industrial uses

A remarkably useful semi-empirical solution to this problem was worked out during WWII by Gurney (Ref 1). Indeed it is the so-called *Gurney formulae*, their origin, modification and application that constitute the major portions of this article. More recently a variety of hydrodynamic computational codes have been developed to calculate fragment velocity (see Ref 6 for example). Although these computations provide "fine structure" not available from the Gurney formulae, they obviously require computer hardware and software and the answer sought, namely the terminal velocity of an explosively-driven fragment, can be obtained as accurately and more economically using the Gurney approach

In what follows we will first consider the basis of the Gurney method and correlate it with detonation theory and hydrodynamics (Section II). The Gurney method will then be compared with more sophisticated expl/metal interaction studies (Section III). Methods of measuring fragment velocities and evaluation of *Gurney constants* will be considered in Section IV. Section V will be devoted to the correlation of empirical Gurney constants with exptl detonation parameters. In Section VI we will address the domain of validity of the Gurney method, and in Section VIII some of its applications. Section VII gives a brief discussion of the use of the Gurney method to estimate explosively-generated impulses. A series of Appendices present derivations and computations

II. The Gurney Method

The Gurney method of calculating the terminal velocity of explosively-propelled fragments was described very briefly in Vol 6, G195-L. Below we present a much more detailed discussion of this useful approach and emphasize its relation to gas dynamics and detonation theory. First we will consider, more or less rigorously, simple one-dimensional (1-D) configurations, and then examine in a more approximate treatment the more complex two-dimensional (2-D) configurations. In the event, it turns out that 1-D theory is simple and straightforward, but its exptl verification is complex, while 2-D theory is com-

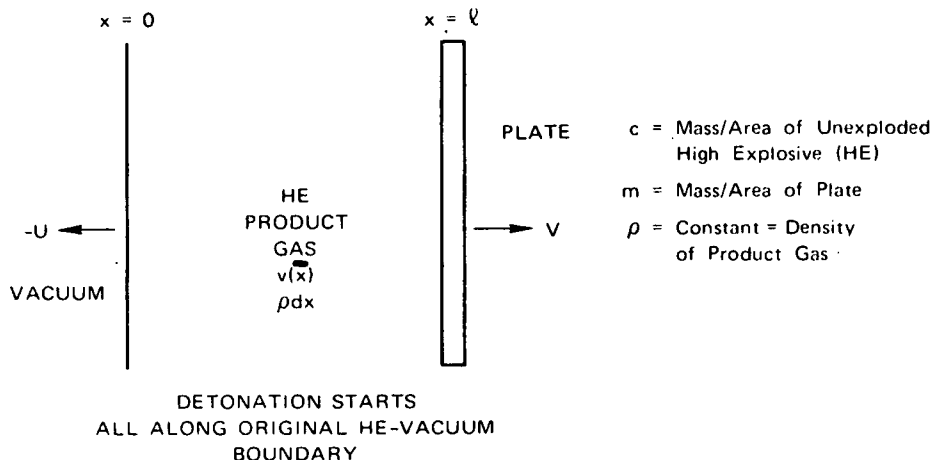

Fig 1 Explosive/Metal Slab

plex, but its expl verification is simple

Gurney's basic assumptions are (Ref 1):

- That at any given time after the expl is detonated there are no density gradients in the detonation products
- The distribution of product gas velocity is linear

Fig 1 shows the situation, at some time after the start of detonation, for a 1-D system consisting of a semi-infinite expl slab, initially in contact with a metal plate on one side and vacuum on the other side, with detonation started simultaneously all along the original HE-vacuum boundary

As indicated, the plate moves to the right at a velocity V and product gases expand into vacuum (in Appendix A it is shown that expansion into air is negligibly different from expansion into vacuum) at velocity -U. The coordinate system used assigns x = 0 to the product/vacuum boundary and x = l to the position of the plate at time t. Then, as taken directly from Ref 14:

"Conserv. of mass

$$\rho l = c \tag{B-1}$$

Conserv. of momentum

$$mV + \rho \int_0^l \rho v(x) dx = 0 \tag{B-2}$$

Gurney assumption of linear gas velocity distribution

$$v(x) = (V + U) \frac{x}{l} - U \tag{B-3}$$

i.e., $x = l, v(x) = V$
 $x = 0, v(x) = -U$

Substituting (B-3) into (B-2),

$$0 = mV + \rho \int_0^l [(V + U) \frac{x}{l} - U] dx =$$

$$mV + \rho \left[\frac{(V + U)x^2}{2l} - Ux \right]_0^l$$

$$0 = mV + (V + U) \frac{\rho l}{2} - \rho l U$$

From (B-1)

$$0 = mV + c/2(V - U)$$

or

$$V = \frac{U}{2m/c + 1} \tag{B-4}$$

Kinetic energy (KE) of gas = $\int_0^l \frac{1}{2} \rho v^2(x) dx$

from (B-3)

$$\begin{aligned} KE &= \frac{\rho}{2} \int_0^l [(V + U) \frac{x}{l} - U]^2 dx = \\ \rho/2 \int_0^l &\left[\left(\frac{V + U}{l} \right)^2 x^2 - 2U \left(\frac{V + U}{l} \right) x + U^2 \right] dx = \\ \rho/2 &[(V + U)^2 \frac{l}{3} - 2U(V + U) \frac{l}{2} + U^2 l] = \\ &\frac{c}{2} \left[\frac{(V + U)^2}{3} - UV \right] \end{aligned}$$

$$\text{gas KE} = \frac{c}{6} [V^2 + 2UV + U^2 - 3UV] =$$

$$\frac{c}{6} [V^2 + U^2 - UV].$$

$$\text{Total KE} = \frac{1}{2} mV^2 + \frac{c}{6} (V^2 + U^2 - UV) \tag{B-5}$$

Eliminating U by means of (B-4) gives

$$\text{Total KE} = \frac{1}{2} mV^2 + \frac{c}{6} [V^2 + V^2(1+2m/c)^2 - V^2(1+2m/c)]$$

$$= \frac{V^2}{2} [m + \frac{c}{3}(1 + 2m/c + 4(m/c)^2)]$$

Setting the total kinetic energy equal to cE* we get

$$cE = \frac{V^2}{2} [m + \frac{c}{3}(1 + 2m/c + 4(m/c)^2)]$$

$$2E = V^2 [m/c + \frac{(1 + 2m/c + 4(m/c)^2)}{3}]$$

$$V = \sqrt{2E} \left(\frac{3}{1 + 5m/c + 4(m/c)^2} \right)^{1/2} \tag{B-6}$$

The system considered above has been extended to a multilayered metal/expl "open-faced sandwich" (Ref 21). Here the effects of rarefactions at the metal/air boundary have to be considered since they lead to separation of the metal layers. According to Jones (Ref 21) the velocity of the innermost layer of the open-faced sandwich configuration of N layers is given by:

$$v_1 = (2E')^{1/2} \left(\frac{(1 + 2M/C)^3 + 1}{6(1 + M/C)} + \frac{m_1}{C} \right)^{-1/2}$$

where the symbols quantities found in Gurney's solutions are replaced by

$$E' \equiv E - (1/C) \sum_{n=2}^N \frac{1}{2} m_n v_n^2,$$

*E = Gurney energy < detonation energy of the explosive

$$M \equiv \sum_{n=2}^N h_n m_n,$$

$$h_1 = 1$$

$$h_n = v_n/v_1, \quad n = 2,3,4$$

The extension of Gurney's equations to multiple layers is similarly accomplished for other geometric configurations of explosive and metal. For a cylindrical explosive charge surrounded by a cylindrical casing of N layers, for example,

$$v_1 = (2E')^{1/2} \left(\frac{m_1}{C} + \frac{1}{2} \right)^{-1/2}$$

where $E' = E = (1/C) \sum_{n=2}^N m_n v_n^2$, and m_n is the mass of the nth layer."

In general for all expl/"metal" configurations:

$$V = \sqrt{2E} f(c/m) \quad (1)$$

where E is characteristic of the driver expl and the function $f(c/m)$ varies with expl/"metal" geometry. The reason that *metal* is enclosed in quotation marks is that the usual material propelled is indeed a metal, but with minor modifications the Gurney method is just as applicable to non-metallic materials. This will be discussed in Section VIII

Consider the situation depicted in Appendix B. Here we have replaced the vacuum (or air) boundary by a rigid wall. Then, as shown in Appendix B:

$$V = \sqrt{2E} (m/c + 1/3)^{-1/2} \quad (2)$$

An important practical configuration is a variant of the system shown in Fig 1. Here the vacuum (or air) boundary is replaced by another metal plate. The mass of the original plate is now m and that of the second plate is m'. A derivation by Abrahamson (Ref 4) leads to the somewhat cumbersome expression:

$$V = \sqrt{2E} \left[\frac{3}{1 + 3 \frac{m}{c} - \left(\frac{2 \frac{m}{c} + 1}{2 \frac{m'}{c} + 1} \right) + \left(1 + 3 \frac{m'}{c} \right) \left(\frac{2 \frac{m}{c} + 1}{2 \frac{m'}{c} + 1} \right)} \right]^{1/2} \quad (3)$$

For the case of $m = m'$, Eqn (3) simplifies to

$$V = \sqrt{2E} (2m/c + 1/3)^{-1/2} \quad (4)$$

For $m/c \gg 1$, and $m'/c \gg m/c$ one obtains:

$$V = \sqrt{2E} \left[\frac{3}{3m/c(1+m/m') - m/m'} \right]^{1/2} \approx \sqrt{2E} \sqrt{c/m} \quad (5)$$

If m' is very large (in effect a rigid wall) but the restriction that $m/c \gg 1$ is removed, Eqn (3) becomes:

$$V = \sqrt{2E} (m/c + 1/3)^{-1/2} \quad (6)$$

which, as expected, is the same formula as that obtained in the rigid wall derivation (Appendix B and Eqn (2))

Although conceptually one can make the systems described by Eqns 2-6 one-dimensional, in practice this would be difficult to achieve because of the simultaneous initiation requirement

We now turn to pseudo-1-D systems, namely a hollow cylinder filled with expl which is initiated simultaneously all along its central axis. This configuration is sketched below (Fig 2) and the derivation of the Gurney formula follows:

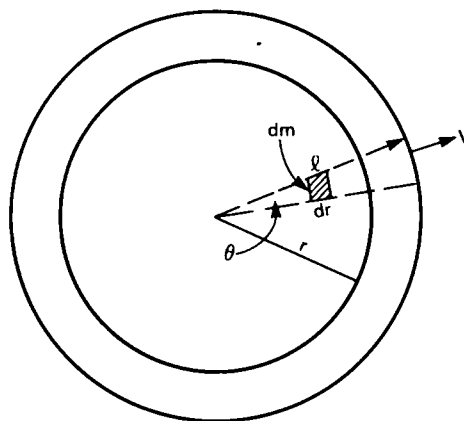

Fig 2 Explosive/Metal Cylinder

Conservation of mass: $C = \pi \rho \ell^2$

Gurney assumption: $v(r) = V(r/\ell)$

K.E. of product gas: $\frac{1}{2} \int v^2(r) dm$
 $dm = \rho r d\theta dr$

$$\text{K.E. of gas} = \rho \frac{V^2}{2} \int_0^{2\pi} \int_0^{\ell} (r/\ell)^2 r dr d\theta =$$

$$\frac{\rho V^2}{2\ell^2} \frac{r^4}{4} \int_0^{2\pi} \int_0^{\ell} =$$

$$\pi \rho \ell^2 V^2 / 4 = c V^2 / 4$$

$$\text{Total K.E.} = m V^2 / 2 + c V^2 / 4$$

If we set this equal to total chemical energy, then:

$$cE = V^2 / 2 (m + c/2) = V^2 / 2 (m/c + 1/2) \quad \text{or}$$

$$V = \sqrt{2E} (m/c + 1/2)^{-1/2} = \sqrt{2E} \sqrt{c/m / (1 + 1/2 c/m)} \quad (7)$$

Eqn (7) is probably the most widely used form of the Gurney equations since many expl/metal configurations involve cylindrical symmetry

In a similar derivation it can be shown (eg, Refs 10 & 11) that for spherical geometry:

$$v = \sqrt{2E} (m/c + 3/5)^{-1/2} \quad (8)$$

Now let us return to the general form of the Gurney Eqn, namely Eqn (1). The right-hand term of Eqn (1) combines three distinct factors: $\sqrt{2E}$, which depends on the characteristics of the driver expl; the form of the function f is determined by the geometry of the system; c/m is the ratio of expl mass to the mass of the material propelled. It is instructive and useful to relate $\sqrt{2E}$ to some more common property of driver expl and this is done below

Consider the system of Fig 1. Assume that the expl slab is detonated simultaneously over the entire expl-vacuum boundary. Let the detonation travel at a shock velocity D and a particle velocity u_j into the expl slab. Let the products expand into vacuum at a particle velocity U , and let the local sound velocities be c in the expanding gas and c_j in the detonating expl. At the expl-vacuum boundary, as shown by Courant and Friedrichs (Ref 2):

$$u_j \pm \int_0^{\rho_j} \frac{cd\rho}{\rho} = U \pm \int_0^{\rho_v} \frac{cd\rho}{\rho} = U \quad (9)$$

since ρ_v , the density of a vacuum, is zero. If we assume that the detonation products are a polytropic gas (ie, the pressure P and density ρ are related by $P = \text{const. } \rho^\Gamma$ where Γ is a constant), then:

$$u_j \pm \frac{2c_j}{\Gamma - 1} = U \quad (10)$$

For the problem under consideration we take the minus sign in Eqn (10), substituting $D - u_j$ for c_j (Chapman-Jouguet condition) and eliminating u_j by means of:

$$u_j = D/(\Gamma + 1) \quad (11)$$

we obtain:

$$U = -D/(\Gamma - 1) \quad (12)$$

If the expl slab is detonated in air instead of in a vacuum, we estimate (Appendix A) that u_a , the expansion velocity into air, is about 1% smaller than U if $\Gamma = 3$; about 2% smaller if $\Gamma = 2.6$; and about 11% smaller if $\Gamma = 2$. For most

expls, $2.5 \leq \Gamma \leq 3$; consequently, the differences between U and u_a will be quite small. Thus we introduce little error in using Eqn (12) for expl products expanding into air rather than into vacuum

The Gurney velocity V of a metal plate, projected by a slab of detonating expl that is initiated simultaneously along its air (or vacuum) face is given by: (See Eqns (B-4) & (B-6))

$$V = \frac{U}{2m/c + 1} \quad (13)$$

or

$$V = \sqrt{2E} \left(\frac{3}{1 + 5m/c + 4(m/c)^2} \right)^{1/2} \quad (14)$$

Eliminating U in Eqn (13) by Eqn (12) and equating Eqns (13) and (14), we obtain:

$$\frac{\sqrt{2E}}{D} = \frac{1}{\Gamma - 1} \left[\frac{\{(1 + 5m/c + 4(m/c)^2)\}^{1/2}}{\sqrt{3(1 + 2m/c)}} \right] = \frac{A}{\Gamma - 1} \quad (15)$$

In Appendix C we show that the term A is nearly constant over the usually encountered range of m/c . For example with $0.1 \leq m/c \leq 3$, $\bar{A} = 0.605$ with a maximum spread of 0.597 to 0.612. Substituting \bar{A} for A , we can rewrite Eqn (15) to get:

$$\frac{\sqrt{2E}}{D} \approx \frac{0.605}{\Gamma - 1} \quad (16)$$

This is an important result because it enables us to estimate the Gurney constant for expls for which $\sqrt{2E}$ has not been determined exptly. It also enables us to choose preferred values of $\sqrt{2E}$ from among the many divergent exptl values previously reported (Refs 10 & 11). Moreover, Eqn (16) is widely applicable because D is known accurately for many expls (or is readily measured) and for most expls $2.5 \leq \Gamma \leq 3$ (see Section V)

We now turn to the examination of 2-D expl/metal configurations. Consider a detonating slab of expl with one lateral face in contact with air or vacuum and the other face in contact with a solid-incompressible plate. Detonation is initiated at the top or bottom of the expl slab rather than at the expl-vacuum boundary. Abrahamson (Ref 4) has shown that for this 2-D configuration the plate velocity is:

$$V = \sqrt{2E'} \left(\frac{3}{(1 + 5m/c + 4(m/c)^2)} \right)^{1/2} \quad (17)$$

where:

$$\sqrt{2E'} = \sqrt{2E} \sqrt{1 - u^2/2E} \quad (18)$$

and $u = u(y)$ is the tangential particle velocity component (with respect to the stationary plate) at a distance y downstream from the detonation front. Derivations of Eqns (17) and (18) are given in Appendix D.

Hoskin et al (Ref 5) have shown that far downstream from the detonation front, where $P(y) \rightarrow 0$:

$$u(y) = \left[\left(\frac{\Gamma^2}{\Gamma^2 - 1} \right)^{1/2} - 1 \right] D \quad (19)$$

From Eqns (18) and (19) we get $\sqrt{2E'}/\sqrt{2E} = 0.98$ and 0.97 for $\Gamma = 3$ and $\Gamma = 2.5$, respectively. These ratios of $\sqrt{2E'}/\sqrt{2E}$ are upper limit estimates, but as will be shown later they are close to the exptly determined values of $\sqrt{2E'}/\sqrt{2E}$.

Near the detonation front $u(y) \approx u_j$. Of course for 2-D configurations u_j is tangential to the plate and not directed towards the plate as in 1-D configurations. Substituting $u = u_j$ in Eqn (18) and using Eqn (16) and the well-known relation $D = u(\Gamma+1)$ we obtain:

$$\sqrt{2E'}/\sqrt{2E} = \sqrt{1 - 2.73(\Gamma-1)^2/(\Gamma+1)^2} \quad (20)$$

At the detonation front according to Eqn (20), $\sqrt{2E'}/\sqrt{2E}$ is 0.563, 0.652 and 0.707 for $\Gamma = 3, 2.7$ and 2.5 respectively.

A somewhat different analysis of conditions near the detonation front was obtained in Ref 14 for the limiting case of $m/c \rightarrow 0$, ie, the expl slab is bounded on both sides by air or vacuum. Near the detonation front of such a system conditions at either detonation products-air boundary can be approximated by the conditions produced when a volume of highly compressed gas suddenly expands into a gas at much lower pressure. This analysis gives results similar to those of Hoskin et al (Ref 5).

The foregoing discussion establishes that the Gurney constant for a 2-D configuration is smaller (but nearly equal to) than the Gurney constant for a 1-D configuration. This conclusion is based upon an analysis of conditions near the detonation front and conditions far downstream from the detonation front. Between these two extremes it seems logical to expect that $\sqrt{2E'} \leq \sqrt{2E}$ still holds. This expectation receives support from the computational results of Hoskin et al (Ref 5) which suggest that $\sqrt{2E'}$ is constant at distances

from the detonation front equal to two widths of the undetonated expl and possibly even at shorter distances.

III. Comparison of the Gurney Formula with Hydrodynamic Calculations

In Section II we have indicated how the semi-empirical Gurney approach can be related in a broad macroscopic sense to the hydrodynamics of the expanding detonation products of the driver expl. In this section we will examine how the Gurney approach relates to several more sophisticated and detailed hydrodynamic treatments that have appeared in the literature.

For a piston driven by a 1-D detonation, with detonation products assumed to be a polytropic gas of $\Gamma = 3$, Aziz et al (Ref 3) used the method of characteristics to get the following analytical solution for the ratio of the terminal piston velocity to the detonation velocity:

$$V/D = \frac{\sqrt{1 + (32/27)c/m - 1}}{\sqrt{1 + (32/27)c/m + 1}} \quad (21)$$

They also obtained numerical solutions for V/D at $\Gamma = 2.5$ and $\Gamma = 3.5$. For $m/c \rightarrow 0$, $V \rightarrow V_{\max}$ and according to Eqn (21) (or extrapolations of the numerical solutions) $V_{\max}/D \rightarrow 1$.

The Gurney-Type treatment of Section II, Eqns (12) and (13), leads to $V_{\max}/D = 1/(\Gamma-1)$ for $m/c \rightarrow 0$. Thus the Aziz et al treatment gives a V_{\max} that is twice that predicted by the Gurney approach for $\Gamma = 3$ detonation products. At the other extreme, $c/m \ll 1$ (eg, $c/m = 0.01$), the Aziz treatment gives $V/D = 0.00295$, in fair agreement with Gurney-type treatment, which gives $V/D = 0.00249$ for $\Gamma = 3$. Actually, as shown in Table 1, agreement between the Aziz and Gurney treatments improves as Γ decreases, but in general V_{Aziz} is some 20 to 30% larger than V_{Gurney} , except at very small c/m .

Aziz et al assumed a rigid incompressible piston in their treatment. Lambourn and Hartley (Ref 6) considered the case of a planar detonation driving a compressible piston. They emphasize the "fine structure" of the process and are particularly interested in the early piston motion. In a macroscopic sense, ignoring "fine-structure" effects, their results agree remarkably well with the simple Gurney-type approach. Their con-

Table 1
Comparison of Aziz and Gurney
1-D Piston Velocities

c/m	V_{Aziz} / V_{Gurney}	
	$\Gamma = 3$	$\Gamma = 2.5$
0	1.000	—
0.01	1.185	—
0.1	1.178	—
1.0	1.158	1.062
3	1.206	1.105
6	1.283	1.171
10	1.354	1.237
∞	2	1.5

clusions will be examined in more detail in Sections V and VI

Flat metal plates and cylinders driven by tangentially incident detonation waves were examined by Hoskin et al (Ref 5) using a 2-D steady state characteristic code. Their computations for plates or cylinders indicate that metal compressibility has little effect on the terminal velocity imparted to the metal by the expl. Thus the Gurney treatment is found to give essentially the same terminal states as their more sophisticated characteristics computation. This is in contrast to the Aziz treatment in which the hydrodynamic 1-D computations gave slightly but consistently higher terminal velocities than the Gurney formula

The computational results of Hoskin et al (Eqn (19) of Section II) suggest that the terminal

velocity in a 2-D system is only slightly smaller than the terminal velocity in a 1-D system of the same m/c and geometry in accord with the results presented in Section II

Studies at Lawrence Radiation Laboratory (LRL) (Kury et al (Ref 7) quoting Wilkins) indicate that in 1-D systems a twofold volume expansion of the detonation products is sufficient to transfer the maximum amount of energy to a metal in contact with these detonation products, but for tangential incidence (2-D systems) a sevenfold volume expansion is required. They state that for explosively driven cylinders observations of the early stages of expansion are expected to provide information on 1-D systems, and measurements of the later stages of expansion are expected to characterize 2-D systems. We will consider their hypothesis in Section IV

An elegant variant of the Aziz et al treatment was performed by Abarbanel & Zwas (Ref 9) who considered the 1-D motion of a rigid piston in a closed-end "pipe". The two equivalent systems examined are shown in Fig 3. In the upper sketch, detonation is initiated at a rigid wall, and in the lower sketch at a plane of symmetry. This system differs from that of Aziz et al in that the boundary condition at the rigid wall (or plane of symmetry) is one of zero particle velocity rather than zero pressure

Piston motion, as shown in t-x diagrams of Figs 4 and 5, is obviously influenced by the rebounding shock from the rigid wall or plane of

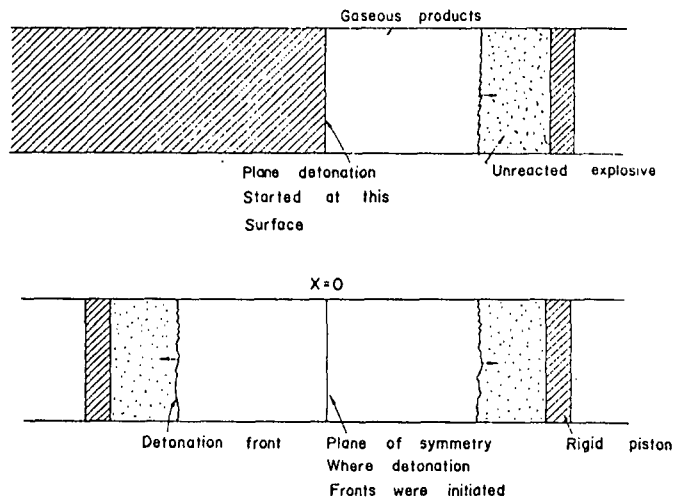

Fig 3

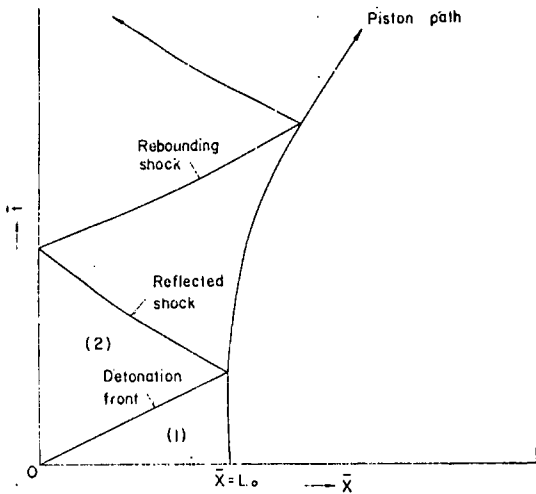

Fig 4

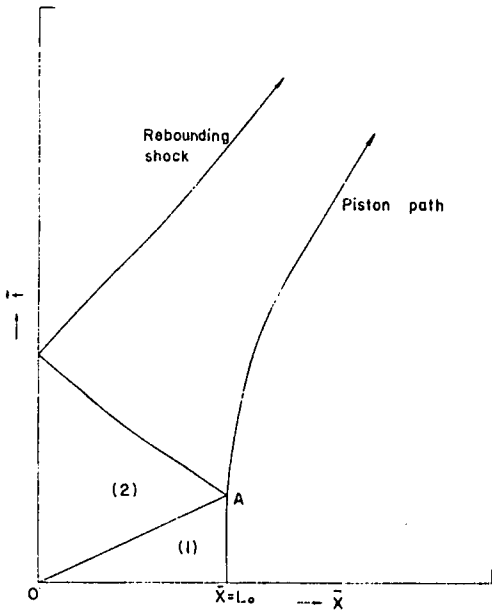

Fig 5

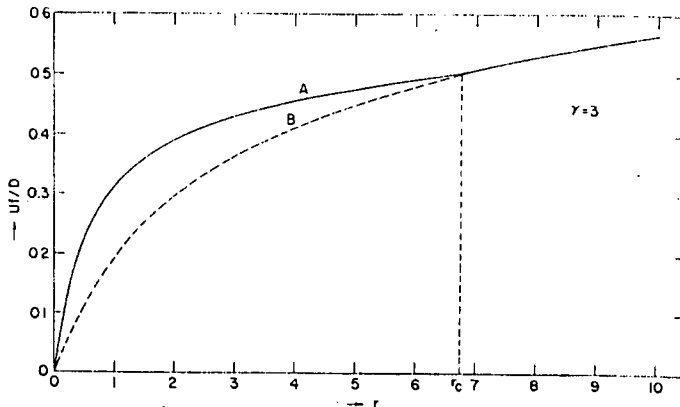

Fig 6 A—Closed-end, B—Open-end

symmetry. In Fig 4 the rebounding shock catches up with the piston and in Fig 5 it does not

Detailed analysis leads to the results shown in Fig 6, which compares computations for the open-end and closed-end "pipes". Note that dimensionless piston velocities coincide above $c/m = 6.7$ ($r = c/m$). The original explanation offered for this effect was that for $r_c = 6.7$ the piston is so light that the rebounding shock cannot overtake it. Subsequent analysis indicated that $r \leq 7.1$ the rebounding shock does indeed *overtake* the piston. This discrepancy was resolved by a more detailed analysis which showed that effects of the rebounding shock of $r_c \leq r \leq 7.1$ are so slight as to be indistinguishable by the numerical methods used in the computations

Hoskin & Lambourn (Ref 26) examined the system of a detonation initiated simultaneously at the expl face in contact with one of *two* metal plates, ie, an asymmetric metal/expl/metal "sandwich". They assumed that the detonation products are isentropic with a constant adiabatic exponent = 3, and showed that the motion of both plates can be determined by the continued reflection of centered simple waves. The path of the reflected shock was followed by an approximate method for two traverses of the detonation products, and the process can be continued indefinitely

The effect of the backing plate was found to be only significant if either or both plates are heavy (relative to the mass of expl), and relatively large flight distances are required if the maximum increase in terminal velocity is to be attained.

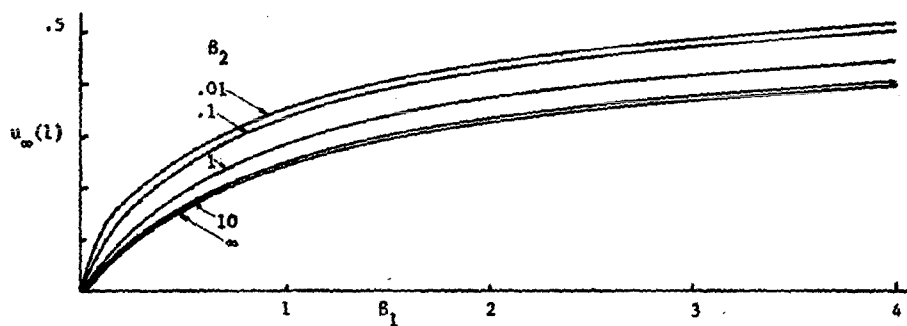

Fig 7 Terminal Velocity of Plate 1

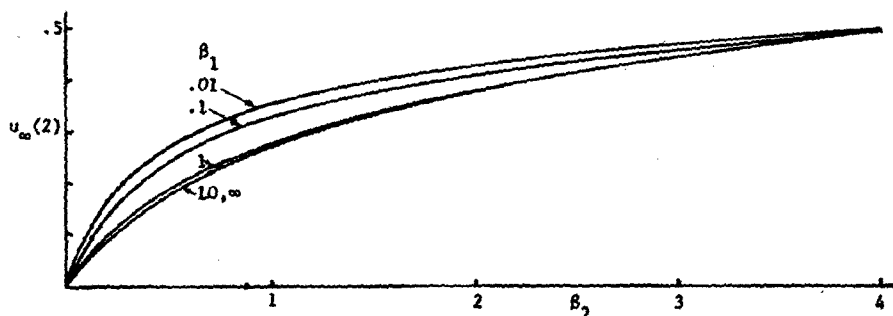

Fig 8 Terminal Velocity of Plate 2

Thus in practical situations it is unlikely that backing plates will provide large increases in impact velocities of explosively driven plates

Their main findings are summarized in the plots in Figs 7 and 8. The quantities u_{∞} , β_1 and β_2 are V_{\max}/D , c/m of plate 1 and c/m of plate 2, respectively, and $\delta = \beta_2/\beta_1$

The plots in Figs 9 and 10 show that as far as efficiency of energy transfer to the plates is concerned the Gurney method is in good accord with their calculations except at $c/m \leq 0.5$

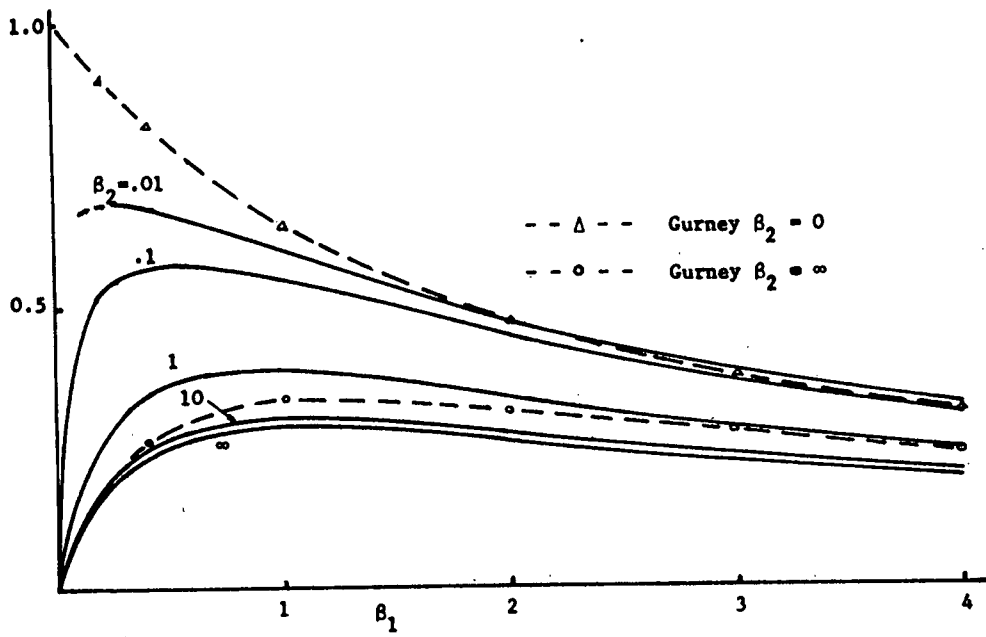

Fig 9 Efficiency of Energy Transfer to Plate 1

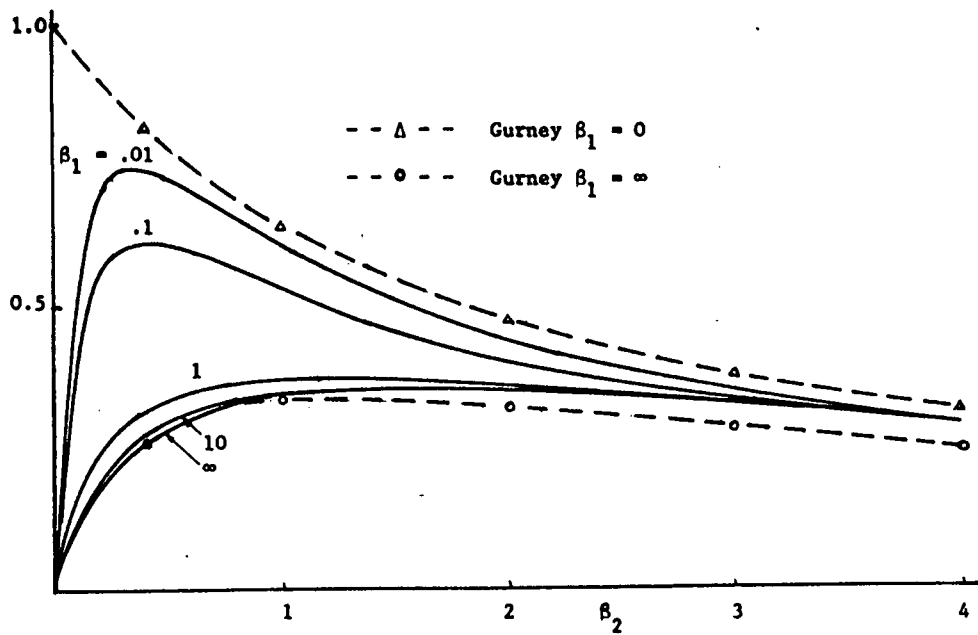

Fig 10 Efficiency of Energy Transfer to Plate 2

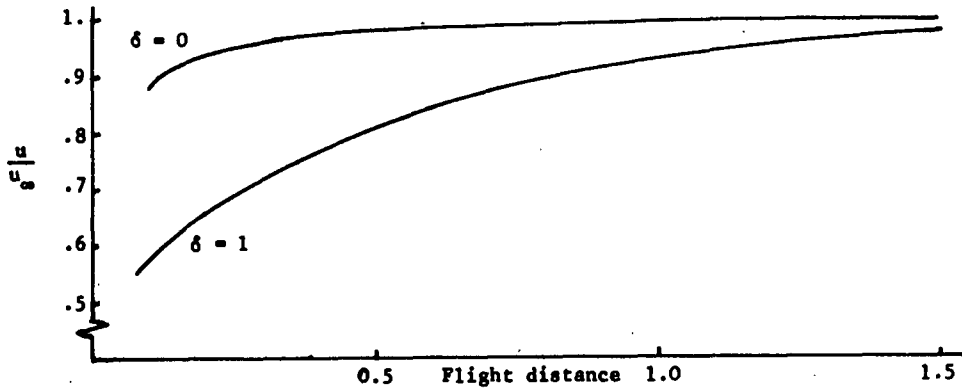

Fig 11 Ratio of Instantaneous Velocity to Terminal Velocity for Plate 2

Finally, the plot in Fig 11 shows their calculations for the ratio of instantaneous velocity to terminal as a function of flight path distance in terms of expl thickness; ie, 0.5 on the plot is a flight distance equal to 0.5 of the expl thickness, etc

IV. Empirical Determination of the Gurney Constants $\sqrt{2E}$ and $\sqrt{2E'}$

In Section I we briefly considered the applicability of the Gurney approach to the design and interpretation of expts using flying plates propelled by expls. In Section II we derived some simple relations between the Gurney constant $\sqrt{2E}$ and detonation parameters of the driver expl, eg, Eqn (16). It is obvious that we need reliable values of the Gurney constants for (a) designing future expts, (b) interpreting existing data, and (c) checking the validity of the theoretical considerations of Section II. In this section we will compute and tabulate $\sqrt{2E}$ and $\sqrt{2E'}$ for driver expls for which we can readily find existing measurements of plate velocity or cylinder expansion velocities

We will consider the exptl data for 1-D and 2-D systems separately. For 1-D configurations, theory is straightforward, but as will become apparent, there is some ambiguity in the measurements of $\sqrt{2E}$. Conversely, for 2-D systems theory is somewhat indeterminate, but exptl measurements of $\sqrt{2E'}$ can be made unambiguously

A. 1-D Configuration

By measuring the terminal velocity of a plate driven by a planar detonation one can, in principle, obtain $\sqrt{2E}$ for the driver expl by using Eqn (14). In practice, this approach is complicated by the necessity of using a plane wave generator to produce a planar detonation in the driver expl

Usually a plane wave generator (PWG) consists of several different expl components, some or all of which are likely to be different expls from the main driver charge. Obviously the PWG contributes energy to projecting the plate, and an estimate of its contribution must be made before one can determine $\sqrt{2E}$ for the main driver charge. The procedure adopted in Ref 14 for "correcting" for the presence of a PWG is as follows. Let l and h be the respective thicknesses of the main driver charge and the metal plate and ρ_c and ρ_m their respective densities. If no PWG is used, then $m/c = \rho_m h / \rho_c l$. Assume that the contribution of any given PWG can be expressed in terms of an extra length L of the main charge. This length L varies for different main charge expls in the sense that $L_1 < L_2$ for $\sqrt{2E_1} > \sqrt{2E_2}$. Thus for a system containing a PWG we replace m/c by:

$$m'/c = \rho_m h / \rho_c (l + L) \quad (22)$$

When exptl measurements of terminal plate velocities are available for a given PWG and for several different thicknesses of a given driver expl, we use a trial and error approach to solve

Table 2
Gurney Constants $\sqrt{2E}$ for 1-D Systems^a

Driver Explosive	Average $\sqrt{2E}$ (mm/ μ sec)	Range of $\sqrt{2E}$ (mm/ μ sec)	Number of Measurements
PBX 9404	3.28	3.17 – 3.43	40
Comp B	2.87	2.76 – 2.98	43
TNT	2.53	2.50 – 2.55	4
TNT ^b	2.43	2.29 – 2.65	4
PBX 9205	3.06	2.90 – 3.21	2
PBX 9010	3.13	—	1
Baratol	1.62	1.47 – 1.71	10

^a Detailed data are given in Appendix E, Table E-1

^b G.I. Kanel et al, FizGorVzryva **10**, 884 (1974); $\rho_0 = 1.55 \text{ g/cm}^3$

Eqns (14) and (22) simultaneously. Usually we know $\sqrt{2E'}$ for the driver expl in 2-D systems. Thus we have a good first guess for $\sqrt{2E}$, since we expect that $\sqrt{2E} \approx \sqrt{2E'}$

Since the equation for computing $\sqrt{2E}$ (Eqn (14) is insensitive to moderate decreases in m/c in the range of 0.1 to 0.2 (many of the existing plate velocity measurements are in this m/c range), the differences in $\sqrt{2E}$ computed on the basis of m/c or m'/c are often quite small (see Appendix E)

Flyer velocity data for 1-D configurations were used to compute the Gurney constants for the six expls shown in Table 2. Most of the data for PBX 9404, Comp B, and Baratol are from SRI flyer plate experiments, and the other data are largely from LRL. The PWG's are either P-80's or P-120's (for the six-inch-thick drivers), and we have assumed the same L for both. The flyer plates were Al, stainless steel, or brass

None of the shots were specifically designed to obtain $\sqrt{2E}$. Thus some of the flyer velocity measurements were made over comparatively short flight paths. If the flight path was too short, the plate was still being accelerated and had not reached its terminal velocity. We have therefore normalized our results to a flight path of 1.5 inches, which, according to considerations to be presented in Section VI, is sufficiently long for a plate to reach terminal velocity. Com-

parison of columns 7 and 9 of Table E-1 shows that after normalization the results are more consistent than before normalization and that the unnormalized $\sqrt{2E}$'s are slightly smaller than the normalized $\sqrt{2E}$'s

In Section III we quoted LRL's suggestion that the early stages of expansion of an explosively driven cylinder behave like a 1-D system (called "head-on" detonation in Ref 7). The results of Table 3 support this idea. In Table 3 we compare LRL's relative $\sqrt{2E}$ values with the relative values we have computed from the average $\sqrt{2E}$'s of Table 1. Agreement between the two sets of relative values is excellent

Table 3
Relative $\sqrt{2E}$ for 1-D Configurations

Driver Explosive	Relative $\sqrt{2E}$	
	From Table 1	From Ref 7
Comp B	1.00	1.00
PBX 9404	1.14	1.10
TNT	0.88	0.87
PBX 9010	1.09 ^a	1.03
PBX 9205	1.01 ^a	1.01 ^b
PBX 9205	1.12 ^a	> 0.99 ^b

^a Single measurement

^b Ref 7 gives this value for an expl compn of 90/8/2 RDX/Polystyrene/DOP; PBX 9205 is 92/6/2 RDX/Polystyrene/DOP

B. 2-D Configuration

There are many exptl measurements of plate velocities or metal cylinder expansions from which we can obtain $\sqrt{2E'}$, the Gurney constant for 2-D configurations. We have chosen to rely primarily on LRL data (Ref 7) of cylinder expansion, but we will demonstrate that the LRL data lead to $\sqrt{2E'}$ values in agreement with values obtained from the plate velocity experiments of Hoskin et al (Ref 5), Defourneaux & Jacques (Ref 12), and Akst (Ref 28) for cylinder expansion

We summarize our computations of $\sqrt{2E'}$ in Table 4. The source of the exptl data for these computations is given in column 4 of the table. The table is divided into five groupings. In the first grouping we examine data obtained in different laboratories and for different geometries. It is evident that $\sqrt{2E'}$ does not depend on geometry, since the same $\sqrt{2E'}$ is obtained for a given expl regardless of whether exptl data were obtained with plates or with cylinders. This is of course expected, since it is the form of the Gurney equations that changes with geometry and not the Gurney constant. For a given expl, data obtained at different laboratories using different exptl techniques usually give very consistent values of $\sqrt{2E'}$, eg, for Comp B $2.66 \leq \sqrt{2E'} \leq 2.76 \text{ mm}/\mu\text{sec}$ for six different data sources

The second grouping is based almost entirely on LRL data (Ref 7). The expls in this grouping are HMX or HMX in combination with TNT or inert materials. An interesting aspect of these data is that the Gurney constant for HMX/inert mixts is well represented by:

$$\sqrt{(2E')_{\text{mixt}}} \approx \sqrt{(2E')_{\text{HMX}}} \sqrt{\theta_{\text{HMX}}} \quad (23)$$

where θ_{HMX} is the weight fraction of HMX in the mixt, and $\sqrt{2E'_{\text{HMX}}}$ is the Gurney constant for pure HMX. A derivation of Eqn (23) based on the Gurney formula for cylindrical geometries is given in Appendix F. Eqn (23) does not hold too well for HMX/TNT mixts; a similar mixt formula is given in Ref 16

The third grouping consists of three expls that do not quite fit into the other groupings. Nitromethane is the only liq expl for which we have data for computing $\sqrt{2E'}$

In the fourth grouping in Table 4 we show LRL data for HMX/Al/inert and HMX/perchlorates/inert mixts. If we use Eqn (23) and assume

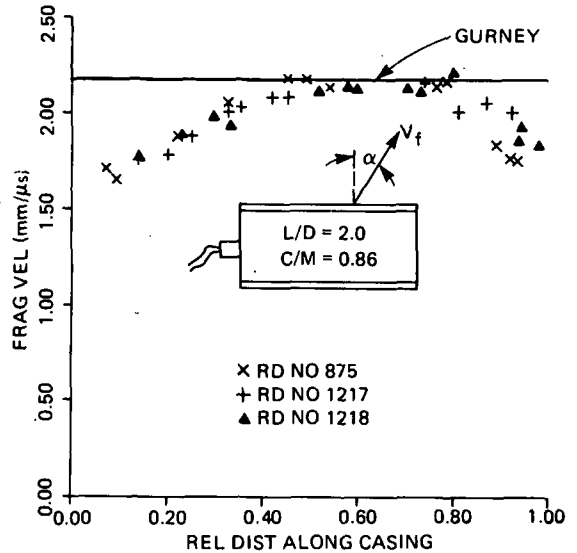

Fig 12 Comparison of Gurney Calculations with Experimental Data for Octol Filled Cylinders

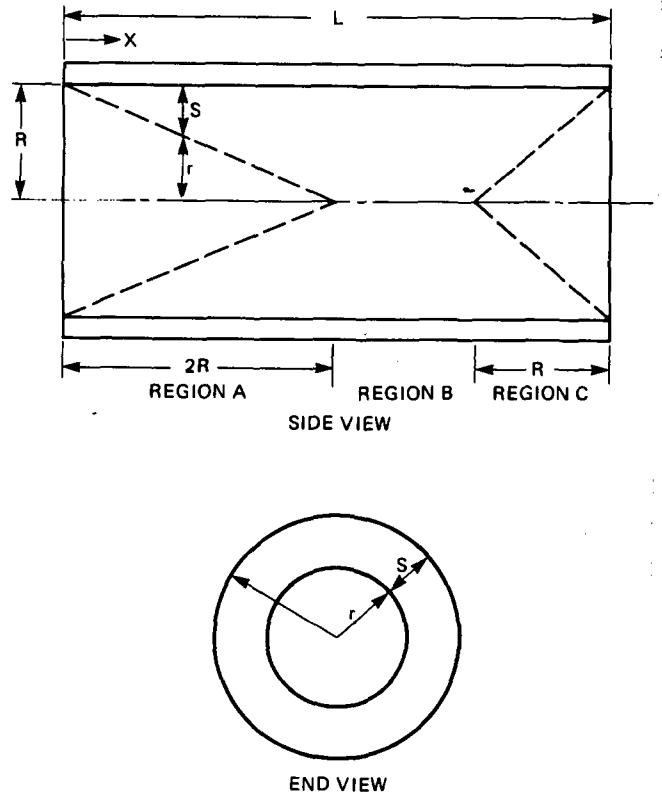

Fig 13 Modification for Cylinder Filled with Explosive

Table 4
Gurney Constants, $\sqrt{2E'}$ for 2-D Systems

Driver Explosive	ρ_0 (g/cc)	Geometry	Data ^a Source	Average $\sqrt{2E'}$ (mm/ μ sec)
Comp B.	1.65	Plate	Hoskin, Ref 5	2.70
Comp B.	1.72	Plate	Crosby, Ref 3a	2.66
Comp B.	1.73	Plate	Defourneaux, Ref 12	2.68
Comp B.	1.65	Cylinder	Hoskin, Ref 5	2.68
Comp B.	1.717	Cylinder	LRL, Ref 4	2.76
Comp B.	1.717	Cylinder	PA, Ref 17	2.70
Comp B.	?	Cylinder	Army, Ref 10	2.68
Comp B.	1.72	Cylinder	Akst, Ref 28	2.80
Comp B.	1.73	Cylinder	Defourneaux, Ref 12	2.83
77 RDX/23 TNT (Cyclotol) ...	1.754	Cylinder	LRL ^a , Ref 7	2.84
75 RDX/25 TNT	1.745	Cylinder	Defourneaux, Ref 12	2.86
90/10 RDX/KelF	1.787	Cylinder	LRL ^a , Ref 7	2.83
TNT	1.63	Cylinder	LRL ^a , Ref 7	2.41
TNT	1.63	Cylinder	Akst, Ref 28	2.49
TNT	1.66 ?	Plate	Defourneaux, Ref 12	2.26
TNT	?	Cylinder	Army, Ref 10	2.41
<hr/>				
HMX.	1.891	Cylinder	LRL, Ref 13	3.11
HMX.	1.19	Cylinder	LRL, (b)	2.74
PBX 9404	1.84	Cylinder	LRL ^a , Ref 7	2.98
95 HMX/5 Viton (LX-10).....	1.862	Cylinder	LRL, Ref 7	3.06
95 HMX/5 inert	1.78	Cylinder	Hoskin, Ref 7	2.92
90 HMX/10 Viton (LX-07).....	1.860	Cylinder	LRL, Ref 13	2.97
85 HMX/15 Viton (LX-04).....	1.865	Cylinder	LRL, Ref 13	2.84
80 HMX/20 Viton (LX-11).....	1.876	Cylinder	LRL ^a , Ref 7	2.80
92 HMX/8 PE.....	1.79	Cylinder	LRL ^a , Ref 7	2.86
90 HMX/10 inert (PBX 9011) ..	1.777	Cylinder	LRL ^a , Ref 7	2.79
88 HMX/12 inert.....	1.798	Cylinder	LRL ^a , Ref 7	≥ 2.86
83 HMX/17 Teflon	1.911	Cylinder	LRL ^a , Ref 7	≥ 2.78
78 HMX/22 TNT (Octol).....	1.821	Cylinder	LRL ^a , Ref 7	≥ 2.89
78 HMX/22 TNT (Octol).....	1.82	Cylinder	Akst, Ref 28	2.93
68 HMX/30 TNT/2 inert.....	1.78	Cylinder	Hoskin, Ref 5	2.84
65 HMX/35 TNT.....	1.80	Plate	Defourneaux, Ref 12	2.76
<hr/>				
EDD ^c	1.55	Cylinder	Akst, Ref 28	2.56
PETN	1.765	Cylinder	LRL ^a , Ref 7	3.03
PETN	~ 1.5	Cylinder	LRL, (b)	2.90
PETN	~ 1.27	Cylinder	LRL, (b)	2.69
EL506D	1.40	Plate	SRI, Ref 3a	2.50
EL506A	1.48	Cylinder	PI, Ref 8	2.56
ADNT ^d	1.58	Cylinder	Akst, Ref 28	2.64
Nitromethane.....	1.143	Cylinder	LRL ^a , Ref 7	2.51
Nitromethane.....	1.143	Cylinder	LRL, (b)	2.57

(continued)

Table 4 (continuation)

Driver Explosive	ρ_0 (g/cc)	Geometry	Data ^a Source	Average $\sqrt{2E'}$ (mm/ μ sec)
81.6 HMX/4 Al/14.4 Viton	1.893	Cylinder	LRL ^a , Ref 13	2.90
79 HMX/6.6 Al/14.4 Viton	1.913	Cylinder	LRL ^a , Ref 13	2.90
65.7 HMX/18.9 Al/15.4 Viton . .	1.99	Cylinder	LRL ^a , Ref 13	2.83
22 HMX/58 AP/10 Al/10 Viton . .	1.97	Cylinder	LRL ^a , Ref 13	2.85
80.3 HMX/5.9 AP/13.8 inert . . .	1.66	Cylinder	LRL ^a , Ref 13	2.85
51 HMX/39 AP/10 Viton	1.89	Cylinder	LRL ^a , Ref 13	2.98
57 HMX/29 AP/14 inert	1.67	Cylinder	LRL ^a , Ref 13	2.93
69 HMX/17 AP/14 inert	1.67	Cylinder	LRL ^a , Ref 13	2.93
73.6 HMX/26.4 LP	1.988	Cylinder	LRL ^a , Ref 13	3.06
ANFO	0.782	Cylinder	PA, Ref 17	2.02
ANFO	0.82	Cylinder	LRL, Ref 18	2.14
40/60 RDX/AN	1.72	Cylinder	PA, Refs 15 & 17	2.54
40/20/40 TNT/RDX/AN	1.613	Cylinder	PA, Refs 15 & 17	2.50
Amatol ^e	1.61	Cylinder	Akst, Ref 28	2.13

^a Indicates that $\sqrt{2E'}$ is based on LRL's relative cylinder expansion data using Comp B as the standard with $\sqrt{2E'} = 2.76 \text{ mm}/\mu\text{sec}$ for Comp B

^b Private communication from LRL

^c Ethylenediaminedinitrate

^d Ammonium Dinitrotriazolate

^e 59.4% AN of 25 micron particle size

Table 5
Ratios of Gurney Constants for
2-D and 1-D Configurations

Explosive	$\sqrt{2E'}/\sqrt{2E^a}$
HMX	0.91 ^b (LRL)
PBX 9404	0.91 (LRL & SRI)
PBX 9011	0.93 ^b (LRL)
LX-04	0.92 ^b (LRL)
78/22 Octol	0.91 ^b (LRL)
PBX 9010	0.90 ^c (LRL)
PBX 9205	$\sim 0.97^d$ (LRL)
77/23 Cyclotol	0.95 ^b (LRL)
Comp B	0.93 (SRI)
Comp B	0.95 (LRL)
Comp B	0.94 (Hoskins)
TNT	0.92 (LRL & Army)
TNT	0.96 (Akst)
TNT	0.90 (Defourneaux)
PETN	0.94 ^b (LRL)

^a See Tables 4 and E-1 for data and data sources

^b $\sqrt{2E'_x} = (v_x/v_{\text{Comp B}}) 2.87$ and $\sqrt{2E'}$ from Table 4; v_x and $v_{\text{Comp B}}$ at $R-R_0 = 5 \text{ mm}$

^c Based on a single measurement of $\sqrt{2E}$ (see Table 2)

^d $\sqrt{2E'}$ calculated via Eqn (23) with $\sqrt{\theta_m} = 0.957$

that the Al or perchlorates are inert, we find that the calculated $\sqrt{2E'_{\text{mixt}}}$ is less than the observed $\sqrt{2E'}$. Thus it would appear that both Al and perchlorates contribute to the $\sqrt{2E'}$ of the mixt

In the last grouping the expls shown contain ammonium nitrate (AN)

In Section II we showed that theory predicts that $\sqrt{2E}$, the Gurney constant for 1-D configuration, is slightly larger than $\sqrt{2E'}$, the Gurney constant for 2-D configurations. We show the explt verification of this supposition in Table 5. For 14 expls, we find that the average ratio of $\sqrt{2E'}/\sqrt{2E}$ is about 0.93 with a range 0.90 to 0.97

In all of the above cases we have in fact assumed that end rarefactions can be neglected, ie, we have considered semi-infinite systems. In the real world rarefactions cannot be neglected, particularly for small expl/metal configurations. Consequently we will examine the effects of rarefactions for cylindrical expl/metal geometries

Fig 12 (from Ref 24) shows that observed fragment velocities near the ends of a cylindrical

system are lower than the velocities of fragments from the central portions. The latter are in close agreement with Gurney-computed velocities. Note that for the L/d (length/diameter) shown, fragments originating over most of the cylinder (except the ends) have velocities close to Gurney velocities. However, for $L/d \leq 2$, observed velocities (except in narrow central regions) are less than Gurney velocities. This conclusion is also reached in Ref 16. Charron (Ref 24) suggests that this reduction in velocity, ie, the end-effects due to rarefactions, can be modeled by assuming that c/m at the ends is less than the overall c/m of the system. Charron's model is sketched in Fig 13. At the initiation end the cone of "inactive" expl has a base radius of R and height $2R$, and at the opposite end both the radius and height are equal to R . In region B there is no "inactive" expl. In region A, if the cylinder is viewed from the end, the proportional amount of expl at that location is:

$$F(x) = \frac{\text{area of sector S}}{\text{total area}} = \frac{\pi R^2 - \pi r^2}{\pi R^2} = 1 - \left(\frac{r}{R}\right)^2$$

$$= 1 - \left(1 - \frac{x}{2R}\right)^2$$

Similarly in region C, the amount of expl at any one point would be:

$$F(x) = 1 - \left(1 - \frac{L-x}{R}\right)^2$$

The modified Gurney Eqn (for $0.1 \leq c/m \leq 5$) that takes into account end rarefactions then becomes:

$$V_M(x) = \sqrt{2E} \left[\frac{F(x)C/M}{1 + 0.5F(x)C/M} \right]^{1/2} \quad (23a)$$

Similar reasoning (Ref 24) leads to the following Eqn for "end-projectors" which are a variant of the slab geometry examined in Section II:

$$V_M(r) = \sqrt{2E} \left[\frac{\sqrt{3F(r)C/M}}{[(F(r)C/M)^2 + 5F(r)C/M + 4]} \right]^{1/2}$$

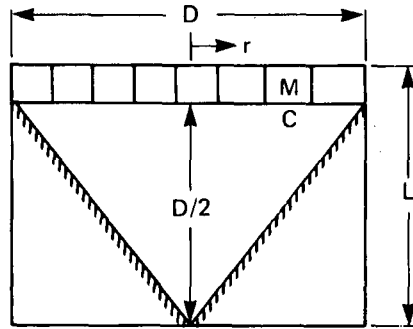

where

$$F(r) = \left[1 - \frac{r(I)}{R} \right]^2$$

The projected fragments in this case are *pre-formed*. Consequently the factor I is included to account for gas leakage between pre-formed fragments. This loss of driving pressure is claimed to be of the order of 10% (Ref 24)

Fig 14 (Ref 24) shows that the modified Gurney formula for cylinders (Eqn 23a) gives quite good agreement with expt when c/m approaches 1; agreement is less satisfactory for $c/m \leq 1/2$

For end-projectors, modified Gurney formulae are not quite as successful, as shown in Fig 15. Some adjustment in "inactive" expl cone angle seems to be indicated

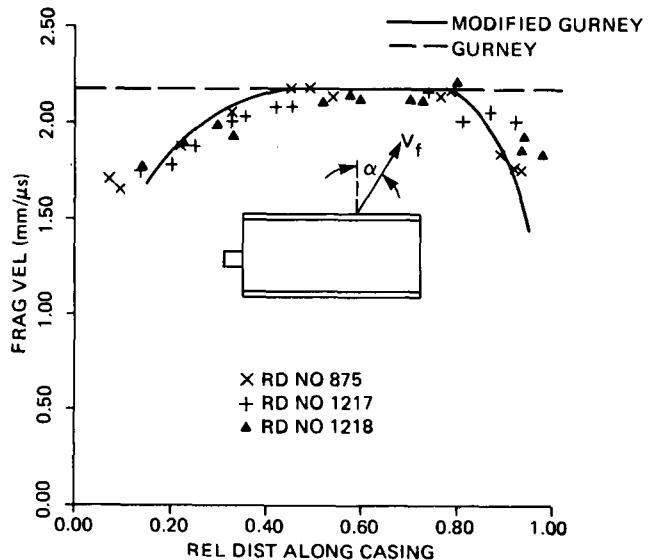

Fig 14 Octol Filled Cylinders ($L/d = 2$; $c/m = 0.86$)

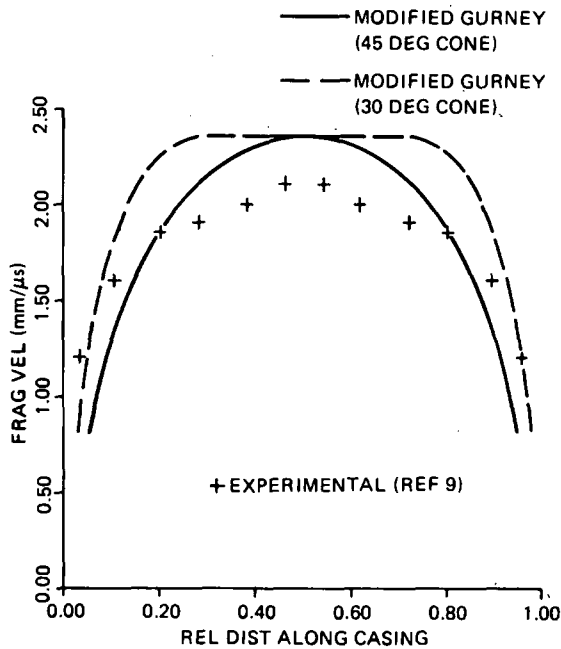
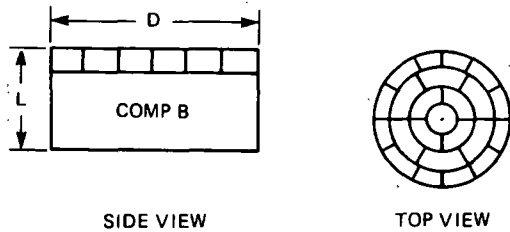

Fig 15 Velocity Distribution for End Projector
 $L/D = 1/2$, $C/M = 2.35$

Jacobs (Ref 16) has attempted to explain why $\sqrt{2E'}$ values measured at NOL were consistently lower than those obtained elsewhere (see Ref 10). He points out certain possible shortcomings in the Gurney assumptions but eventually uses an empirical approach (and not very successfully, in this writer's opinion) to modify the Gurney formula for Comp B-filled cylinders to:

$$v = \sqrt{2E'} (m/c + 0.3)^{-1/2} \text{ for steel casings}$$

$$v = \sqrt{2E'} (m/c + 0.2)^{-1/2} \text{ for Al casings}$$

instead of the standard alternate form (equivalent to Eqn 7):

$$v = \sqrt{2E'} (m/c + 1/2)^{-1/2}$$

V. Correlation of Empirical Gurney Constants with Experimental Detonation Parameters

In this section we will attempt to relate the empirical Gurney constants, or the exptly determined V/D ratios, to exptly determined Chapman-Jouguet pressures, P_J , and polytropic coefficients, Γ

A. Gurney Approach

Eqn (16) relates $\sqrt{2E}$, D , and Γ . If $\sqrt{2E}$ and D are obtained exactly, then Eqn (16) can be used to compute Γ . We have done this and compared these "computed" Γ 's with "experimental" Γ 's obtained from measurements of P_J and D according to:

$$P_J = \frac{\rho_0 D^2}{\Gamma + 1} \quad (24)$$

Before proceeding with the comparison of the computed and exptl Γ 's shown in Table 6, we want to emphasize the following useful empirical generalization. Examination of the column entitled "Average $\sqrt{2E}/D$ " of Table 6 reveals that this quantity changes relatively little from expt to expt. In fact for 13 expls for which we have reliable $\sqrt{2E}$ and D data, the average $\sqrt{2E}/D$ is 0.364 with a range of 0.333 to 0.389. Since D is known accurately for many expls, or is readily measured, we can use the above generalization, aside from any theoretical considerations, to estimate $\sqrt{2E}$ for expls for which there are no exptl $\sqrt{2E}$ data

Now let us return to Eqn (16). For it to be valid, Γ must be nearly constant for most expls, since $\sqrt{2E}/D$ is found to be nearly constant (Table 6). In Section II we implied that $2.5 \leq \Gamma \leq 3$, and this is borne out by the "experimental" Γ 's of Table 6. In some of the early exptl determinations, P_J was probably underestimated; consequently, some of the early values of Γ are probably too high. Unfortunately there is still considerable uncertainty about the best "experimental" values of Γ . A recent study by Davis and Venable (Ref 13a) showed that different techniques for measuring P_J give rather different results and that there is no *a priori* way of determining which of these results is the correct one. Of course any uncertainty in P_J will be reflected in uncertainty in the Γ 's based on the P_J values

Considering the uncertainty in both sets of Γ , agreement between the sets is reasonably good,

Table 6
Comparison of Polytropic Coefficient Γ Based on $\sqrt{2E}$ with
Polytropic Coefficients Based on Chapman-Jouguet Pressures

Explosive	Density g/cc	\bar{D} km/sec	$\sqrt{2E}$ km/sec	$\sqrt{2E/\bar{D}}$	Γ (a)	Γ exptl (b)
Baratol	2.55	4.87	1.62	0.333	2.81	2.97
PBX 9404	1.84	8.80	3.28	0.373	2.62	2.82
PBX 9010	1.78	8.37	3.13	0.343	2.65	2.81
Comp B	1.72	7.89	2.87	0.364	2.66	2.75
TNT	1.62	6.92	2.53	0.366	2.65	2.72
HMX	1.89	9.11	3.42 (c)	0.375	2.61	2.90
Octol	1.82	8.48	3.18 (c)	0.375	2.61	2.82
PETN	1.765	8.28	3.22 (c)	0.389	2.55	2.60
						(2.80) (d)
Cyclotol	1.75	8.30	2.99 (c)	0.360	2.67	2.80

Footnotes:

(a) From $\sqrt{2E}/D = 0.605/(\Gamma - 1)$

(b) From $P_J = \rho_0 D^2 / (\Gamma + 1)$ using exptl P_J and D

Data mostly from Dobratz (Ref 29) and the writer's unpublished compilation (d) of Γ as a function of ρ_0

(c) LRL data for early cylinder expansion (see Table 3)

except that the Gurney Γ 's are consistently 3 to 7% lower than "experimental" Γ 's. We have no explanation for this trend

B. Theory of Aziz, Hurwitz, and Sternburg

We have just shown that, within exptl uncertainty, the Gurney approach leads to values of Γ that are in good accord with Γ 's obtained from P_J measurements. We now wish to examine how the approach of Aziz et al (Ref 3) which appears to be on sounder theoretical grounds than the Gurney treatment, relates to observed detonation parameters. The comparison between theory and expt is best performed in terms of the dimensionless ratio V/D , a quantity for which Aziz et al obtain explicit and numerical solutions in terms of m/c and Γ . This comparison is made in Fig 16, which presents theoretical and exptl V/D ratios as a function of m/c

Most of the exptl data in Fig 16 are for 1-D configurations, except the data for $m/c > 1$, which are for 2-D configurations, since no 1-D results could be found in this m/c range. We used the $\sqrt{2E}/\sqrt{2E'}$ ratios of Table 5 to "convert" the 2-D, V/D values into 1-D, V/D values. Two such estimates labeled "A" are shown in Fig 16

Examination of Fig 16 reveals that the great majority of exptl points lie within the bounds of the two Gurney curves for $\Gamma = 2.6$ and $\Gamma = 2.7$, in agreement with results presented in Table 6. For $m/c < 0.1$ the exptl data points lie above the Gurney curves. We will consider the implications of this observation in the next section

The Aziz et al theory appears to be less successful in matching exptl data than the Gurney theory, except at $m/c < 0.1$. For $m/c \leq 0.3$, the Aziz curve for $\Gamma = 3.16$ is good fit for the exptl data. For $m/c \sim 1$, Γ must be decreased to 3 to obtain a fit, and at m/c of about 2 it appears that Γ must be slightly less than 3. Thus the Aziz et al approach requires a variable Γ to fit exptl data. What is even more disturbing is that these Γ 's ($0 \leq m/c \leq 2$) are all appreciably larger than the Γ 's obtained from Chapman-Jouguet pressure measurements (Table 6)

C. Calculations of Lambourn and Hartley

Lambourn and Hartley also considered the hydrodynamics of 1-D exptl/metal systems (Ref 6). Of particular interest to us is their Fig 5 which gives the metal velocity of a Comp B driven stainless steel plate ($m/c = 0.48$) as a

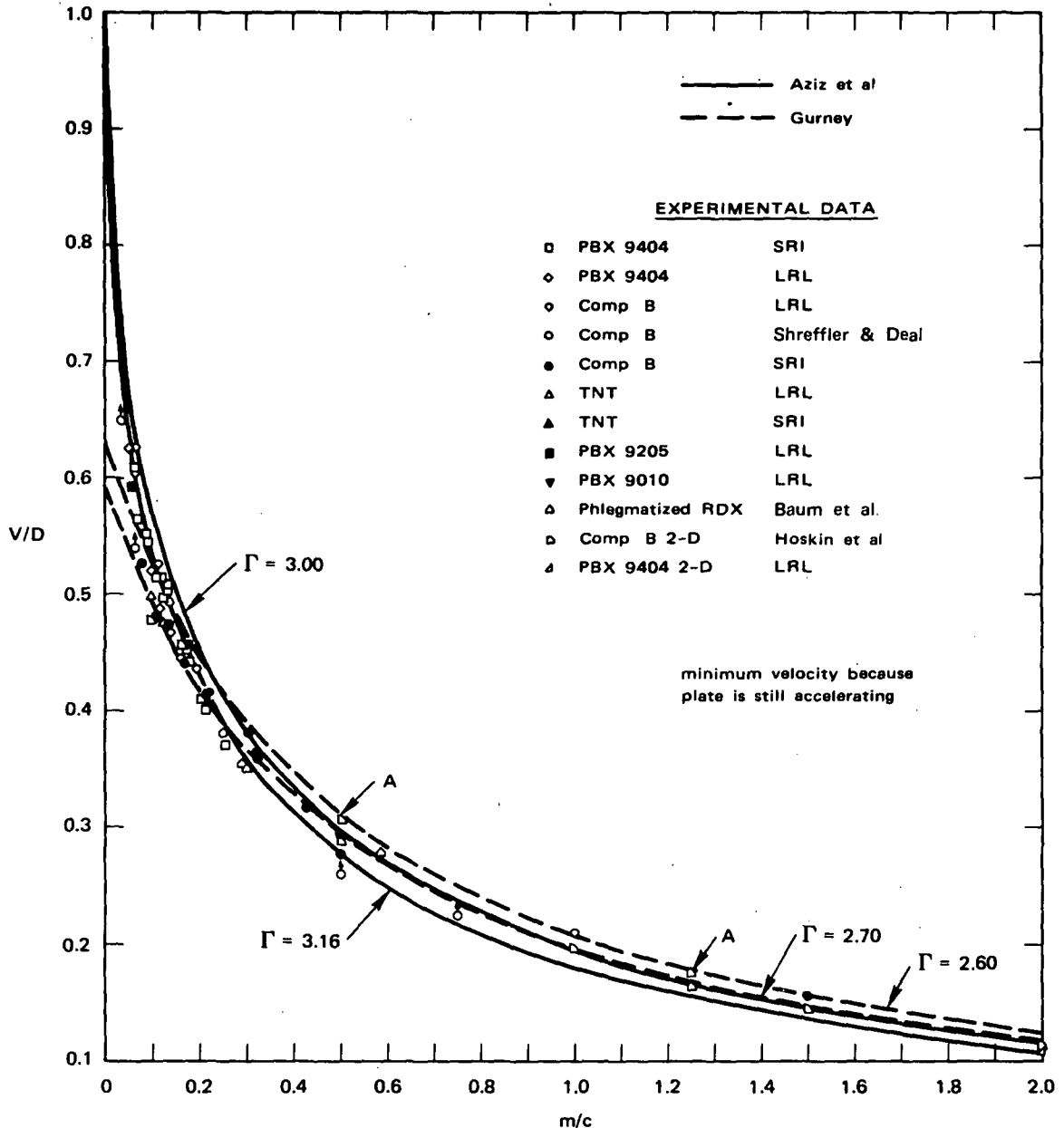

Fig 16 Theoretical and Experimental Plate Velocities

function of the plate flight path. They used three different computational codes. Two of these indicate that the velocity oscillates but that the oscillations are damped out as the flight path increases. For Comp B, the Gurney constant $\sqrt{2E}$, computed from their average plate velocity for a flight distance at which the velocity ap-

proaches a constant value, is $2.88\text{mm}/\mu\text{sec}$. This value agrees remarkably well with the average $\sqrt{2E} = 2.87\text{mm}/\mu\text{sec}$ given in Table 1. Thus the calculations of Lambourn and Hartley, unlike those of Aziz et al, appear to be in excellent agreement with the Gurney theory

D. 2-D Configuration

We have already mentioned that it is difficult to obtain a simple theoretical treatment of the interactions of a metal and the detonation products of the driver expl in 2-D configurations. Nevertheless, we have shown that $\sqrt{2E} > \sqrt{2E'}$. In other words a 1-D configuration is more efficient in propelling a metal than a 2-D configuration, but, as shown in Table 5, this difference in metal driving efficiency is small

The discussion presented in this section as well as Sections II and III make it probable that $\sqrt{2E'}/D \approx \text{constant}$, although we have no rigorous theoretical basis for this expectation. In Table 7 we present the exptl data of Table 4 in the form of $\sqrt{2E'}/D$. For 31 expls the average $\sqrt{2E'}/D$ is 0.347, and the range is from 0.331 to 0.394. Most of the values of 0.36 or higher come from HMX/Al or HMX/perchlorate mixts. For more ordinary expl compns, the "rule of thumb" approximation of:

$$\sqrt{2E'} \approx D/3$$

provides a quick and fairly reliable estimate of $\sqrt{2E'}$

The more accurate equation:

$$\sqrt{2E'} \approx 0.347D \quad (25)$$

is an important semi-empirical result, since it can be used to estimate $\sqrt{2E'}$ when no exptl data are available or to choose a "preferred" value of $\sqrt{2E'}$ from among discordant data. An example of the latter is shown in Table 8. For the seven expls shown in Table 8, 0.347D is quite close to at least one exptly determined $\sqrt{2E'}$. On the average, 0.347D is about 2.8% larger than the "best" exptl $\sqrt{2E'}$

Kennedy (Ref 11) and Hardesty & Kennedy (Ref 19) chose a different approach of relating $\sqrt{2E}$ (or rather $\sqrt{2E'}$) to other detonation parameters, eg, to Q, the heat of detonation. We prefer our scheme because accurate values of D are available for many more expls than accurate values of Q. However, their approach has considerable merit (as will be shown below) for new expls for which only the compn is known and an estimate of Q can be made. In Ref 11, Kennedy claims that $E'/Q \sim 0.7$. In a rough fashion we confirm this claim in Table 9 but, as shown, there is considerable variation (0.54 to 0.78) in the E'/Q ratios for different expls. It is quite clear, however, that $E'/Q < 1$. All these data

are for cylinder expansion and Hardesty and Kennedy point out that upon cylinder rupture expln products escape thru the cracks. Consequently not all the chemical energy of the expl load is utilized in propelling the fragments and it is to be expected that E' obtained from cylinder expansion measurements is less than Q. They also make the interesting observation that the difference between internal energy of isentropically expanded detonation products, E_s , and that of the unreacted expl, E_0 , can be related to $\sqrt{2E'}$. They suggest that E_s should be computed for a three-fold expansion of the original unreacted expl volume. In view of the somewhat larger value of $\sqrt{2E'}$ in Table 4 than the values they quote, perhaps the volume expansion should be a little greater than three-fold

Now most of $\sqrt{2E'}$ data that are based on cylinder expansion velocities (Table 4) are derived from LRL measurements of velocities that appear to approach an asymptote at about seven-fold cylinder expansion. Hershkowitz & Rigdon (Ref 15) used larger cylinders than LRL and obtained velocity measurements of up to 10- to 13-fold expansions. Comparison of these velocities with those obtained for approximately 7-fold expansion is as follows: for Comp B, $v_{10}/v_7 = 1.029$ for "thick-walled" cylinders and 1.027 for "thin-walled" cylinders; for 40/40/20 RDX/TNT/AN, $v_{10}/v_7 = 1.025$ for "thick-walled" cylinders and 1.023 for "thin-walled" cylinders; and for 20/40/40 RDX/TNT/AN, $v_{10}/v_7 = 1.030$ for "thick-walled" cylinders and 1.022 for "thin-walled" cylinders

Thus from the thin-walled data for Comp B (at a 10-fold expansion) one obtains $\sqrt{2E'} = 2.96\text{km/sec}$ and $E'/Q = 0.87$. As shown in Section IV (and in particular in Table 5), a tangentially impinging detonation is less effective in propelling incompressible material than a head-on detonation. When this is taken into account (approx 0.87/0.93) $E' \sim Q$ if E' is based on measurements made at large expansion of the test cylinders

We have mentioned that the Hardesty & Kennedy approach can be useful for new expls for which little more than the elemental compn is known. They have correlated $\sqrt{2E'}$ or rather $\sqrt{2(E_0 - E_s)^{1/2}}$ (at $v/v_0 = 3$) with the product $\rho_0\phi$ where ρ_0 is the expl density and ϕ is the

Table 7
Constancy of $\sqrt{2E'/D}$

Driver Explosive	ρ_c (g/cc)	(mm/ μ sec)	$\sqrt{2E'/D}$ ^a
Comp B	1.65	7.75	0.348
Comp B	1.72	8.0	0.333
Comp B	1.73	8.07	0.326 ^b
Comp B	1.65	7.75	0.346
Comp B	1.717	7.99	0.345
77 RDX/23 TNT	1.754	8.25	0.346
75 RDX/25 TNT	1.745	8.24	0.347
90/10 RDX/KelF	1.787	8.39	0.345
TNT	1.63	6.94	0.353
TNT	1.66 (?)	6.95	0.326 ^b
<hr/>			
HMX	1.891	9.11	0.344
PBX 9404	1.84	8.80	0.339
95 HMX/5 Viton	1.862	8.82	0.348
95 HMX/5 Inert	1.78	8.73	0.334
90 HMX/10 Viton	1.860	8.65	0.348
85 HMX/15 Viton	1.865	8.47	0.342
80 HMX/20 Viton	1.876	8.32	0.337
92 HMX/8 PE	1.719	8.63	0.331
88 HMX/12 Inert	1.798	8.38	0.344
83 HMX/17 Teflon	1.911	8.42	0.331
78 HMX/22 TNT	1.821	8.48	0.341
68 HMX/30 TNT/2 Inert	1.78	8.21	0.347
65 HMX/35 TNT	1.80	8.14	0.335
<hr/>			
PETN	1.765	8.27	0.368
EL506D	1.40	7.3	0.344
Nitromethane	1.143	6.37	0.394
<hr/>			
81.6 HMX/4 Al/14.4 Viton	1.893	8.44	0.344
79 HMX/66 Al/14.3 Viton	1.913	8.43	0.345
65.7 HMX/18.9 Al/15.4 Viton	1.99	8.16	0.347
22 HMX/58 AP/10 Al/10 Viton	1.97	6.54	0.436 ^b
80.3 HMX/5.9 AP/13.8 Inert	1.66	8.19	0.349
51 HMX/39 AP/10 Viton	1.89	8.12	0.361
57 HMX/29 AP/14 Inert	1.67	7.76	~0.38 ^b
69 HMX/17 AP/14 Inert	1.67	8.05	0.355
73.6 HMX/26.4 LP	1.988	8.43	0.364

^a $\sqrt{2E'}$ values taken from Table 4.

^b Omitted from average

Table 8
"Preferred" Values of $\sqrt{2E'}$

Explosive	Composition	D (mm/ μ sec)	Reported ^a $\sqrt{2E'}$ (mm/ μ sec)	"Best" ^b $\sqrt{2E'}$ (mm/ μ sec)	0.347D ^b (mm/ μ sec)
Tetryl		7.4 at 1.65g/cc	2.27–2.50 (5)	2.50	2.57
Pentolite	50/50 PETN/TNT	7.5 at 1.66g/cc	2.18–2.56 (5)	2.56	2.60
Comp C-3	77/3/4/10/5/1 RDX/Tetryl/TNT/ DNT/MNT/NC	7.6 at 1.6g/cc	2.18–2.69 (6)	2.62	2.64
Comp A-3	91/9 RDX/Tetryl	8.2 at 1.6g/cc	2.40–2.74 (4)	2.74	2.85
Baratol	76/24 Ba(NO ₃) ₂ /TNT	4.9	1.41–2.07 (6)	1.59	1.70
HBX-1	40/38/17/5 RDX/TNT/Al/Inert	7.3 at 1.7g/cc	2.21–2.47 (6)	2.47	2.53
EL506D	75/25 PETN/binder	7.3	1.9–2.50 ^c (3)	2.50	2.57

^a Number in brackets is the number of reported $\sqrt{2E'}$ values in Ref 10

^b "Best" $\sqrt{2E'}$ is the reported value closest to 0.347D

^c Includes unpublished SRI data

Table 9
Comparison of Gurney Energies
with Heats of Detonation*

Explosive	$\sqrt{2E'}$ (km/sec)	Q (kJ/g)	E'/Q
HMX	3.11	6.19	0.78
PETN	3.03	6.23	0.74
Tetryl	2.50 (a)	4.56	0.69
TNT	2.42	4.56	0.64
NM	2.54	5.15	0.63
PBX 9404	2.98	5.77	0.77
Comp B	2.76	5.02	0.76
LX-04	2.84	5.49	0.73
LX-11	2.80	5.15	0.76
ANFO	2.02	3.72 (b)	0.58

* $2E'$ from Table 4 and Q from Ref 29

(a) From Ref 10

(b) Calculated

Kamlet parameter that depends on expl compn (see article on *Velocity of Detonation* in this Vol). Their correlation is shown in Fig 17

Kamlet & Finger (Ref 23) propose a somewhat simpler empirically-fitted correlation, namely, $\sqrt{2E'} = 0.887\varphi^{0.5}\rho_0^{0.4}$. It should be emphasized that this correlation, as well as the one in Fig 17, are based on isentrope expansion calcns with all their inherent uncertainties as to the equation of state to be used for the expansion detonation products

VI. Domain of Validity of the Gurney Formula

As shown in Fig 16, the exptly measured plate velocities for $m/c < 0.1$ are greater than predicted by the Gurney formula with a constant $\sqrt{2E'}$, but for $m/c \geq 0.1$ the Gurney formula is in excellent accord with expt. We now want to examine this discrepancy

Let us reexamine the semi-infinite slab of expl considered in Section II. In the limit of a vanishingly thin metal plate the expl is bounded on both sides by vacuum (or air). If detonation starts simultaneously at one of the vacuum boundaries and proceeds towards the other vacuum boundary (ie, towards the infinitesi-

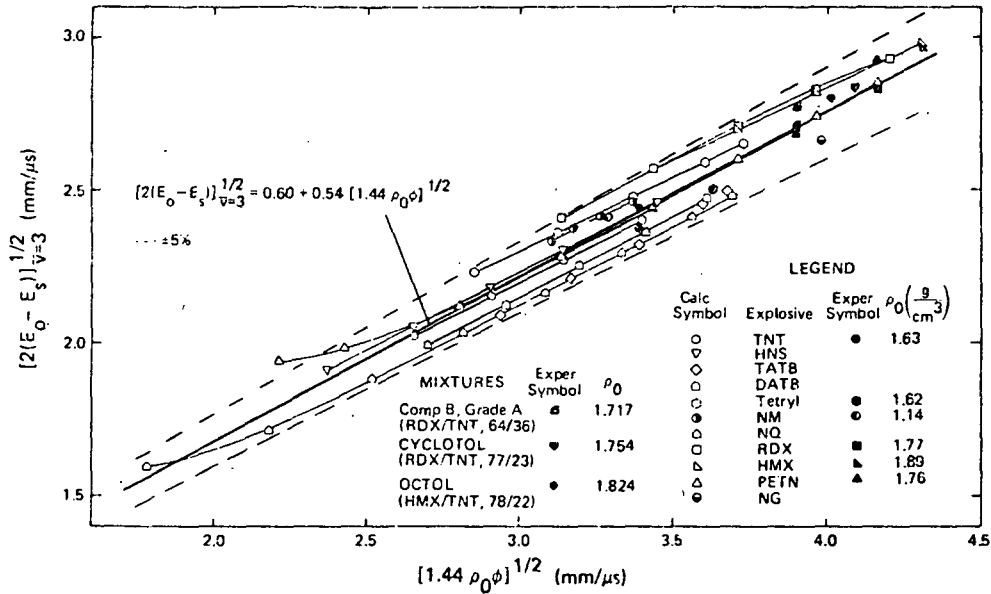

Fig 17 Computed Gurney velocity, $[2(E_0 - E_s)]^{1/2}$, as a function of the characteristic velocity, $[1.44\rho_0\phi]^{1/2}$ (mm/ μ sec), for C-H-N-O explosives at various initial loading densities. Least squares fit to calculated values is shown. Also shown are experimental values of Gurney velocity (Ref 10), $\sqrt{2E_g}$, for maximum loading density for six pure explosives and three mixtures

mally thin metal plate), then according to Eqn (10) (using the plus sign and designating the infinitesimally thin plate velocity as V'_{max}):

$$V'_{max} = u_J + \frac{2c_J}{\Gamma - 1} = \left[\frac{3\Gamma - 1}{\Gamma - 1} \right] u_J \quad (26)$$

For the special case of $\Gamma = 3$, Eqn (26) becomes:

$$V'_{max} = 4u_J \approx D \quad (27)$$

and for the general case of any Γ :

$$V'_{max}/D = \frac{3\Gamma - 1}{\Gamma^2 - 1} \quad (28)$$

This result is quite different from that obtained previously in Section II where according to Eqn (12) and Eqn (13) one obtains:

$$V'_{max}/D = 1/\Gamma - 1 \quad (29)$$

Eqn (29) gives a lower plate velocity for $m/c \rightarrow 0$ than the plate velocity calculated by Eqns (26) and (28). Because Eqns (26) and (28) are based on hydrodynamics and do not contain any Gurney-type assumptions, they are on firmer theoretical foundations than Eqn (29), and in the limit of $m/c \rightarrow 0$ (or $c/m \rightarrow \infty$) they should

give more realistic values of plate velocity than Eqn (29). Of course Eqns (26) and (28) are not applicable to finite values of c/m , for example, $m/c > 0.1$

It is interesting to compare the results of Aziz et al (Ref 3) with the above considerations. Their explicit Eqns (3.11) and (3.12) for $\Gamma = 3$ are directly comparable with our Eqn (27), and their approximate Eqn (5.3) (based on numerical computations) is comparable to our Eqn (28). For $m/c \rightarrow 0$, Eqns (3.11) and (3.12) give $V_{max} = D$ in complete agreement with Eqn (27). For $m/c \rightarrow 0$, their Eqn (5.3) can be put into the form

$$V_{max}/D = 4\sqrt{2}(\Gamma^e - 1)^{1/2} \quad (30)$$

At first glance Eqns (28) and (30) appear to be quite different, but this is not the case. For $\Gamma = 3$, Eqns (30) and (28) are exactly equal, and for $2.5 \leq \Gamma \leq 3.5$ the maximum difference between them is less than 1/2% when $m/c \rightarrow 0$

What we have just shown is that a simple hydrodynamic treatment (Eqns (26) to (28)) or the more sophisticated approach of Aziz et al are in good agreement with each other and with expt for $m/c \rightarrow 0$. For $m/c > 0.1$, however, as

discussed in Section V, the equations deduced by Aziz et al do not agree with expt unless Γ decreases as m/c increases. Moreover, all these Γ 's are greater than the Γ 's based on P_j measurements. Thus the Gurney approach appears to fail for $m/c \leq 0.1$, and the Aziz et al approach appears to fail (or at least lead to inconsistencies) for $m/c \geq 0.1$. Even for $0 < m/c \leq 0.1$, the Aziz et al theory requires an unrealistically large Γ of about 3.2 to fit exptl data

We cannot at this time point out the fallacies, if any, in the Aziz et al theory; we can only point to its shortcomings. From Fig 16 it is apparent that the Gurney formula gives a better and more consistent fit to expt over most of the studied range of $0.1 \leq m/c \leq 3$ than the Aziz et al approach

A. Plate Velocity as a Function of Flight Path for 1-D Configurations

In computing $\sqrt{2E}$ from exptl plate velocity data, we adopted the procedure of normalizing plate velocities to a flight path of 1 1/2 inches (Section IV). We now present justifications for this procedure. Aziz et al (Ref 3) present a series

of curves of the ratio $V(t)/V$ as function of m/c and the scaled flight time Dt/ℓ , where t is the flight time, D is the detonation velocity, ℓ is the expl thickness, and V is the terminal plate velocity. Their curves are replotted in Fig 18 which also contains an averaged curve taken from the computations of Lambourn and Hartley (Ref 6) who used computational procedures that are different from those employed by Aziz et al. Fig 18 also shows exptl data. Agreement between the theoretical curves of Aziz et al and Lambourn and Hartley is quite good, but agreement between theory and expt is less satisfactory. The exptl data scatter rather widely, but their general trend is that predicted by theory except that the effect of m/c is less than predicted by theory

The exptl data of Fig 18 suggests that $V(t) \approx V$ for $Dt/\ell \geq 1$. Let us examine whether this observation fits our normalization procedure. As an example, consider a representative system of $m/c = 0.2$, $\sqrt{2E} = 3\text{mm}/\mu\text{sec}$, $D = 8\text{mm}/\mu\text{sec}$, $\ell = 100\text{mm}$ (~ 4 inches), and a flight path of 38mm (~ 1.5 inches). For this system $V \sim 3.5 \text{ mm}/\mu\text{sec}$, $t \approx 38/3.5 \approx 11 \mu\text{sec}$, and $Dt/\ell \approx$

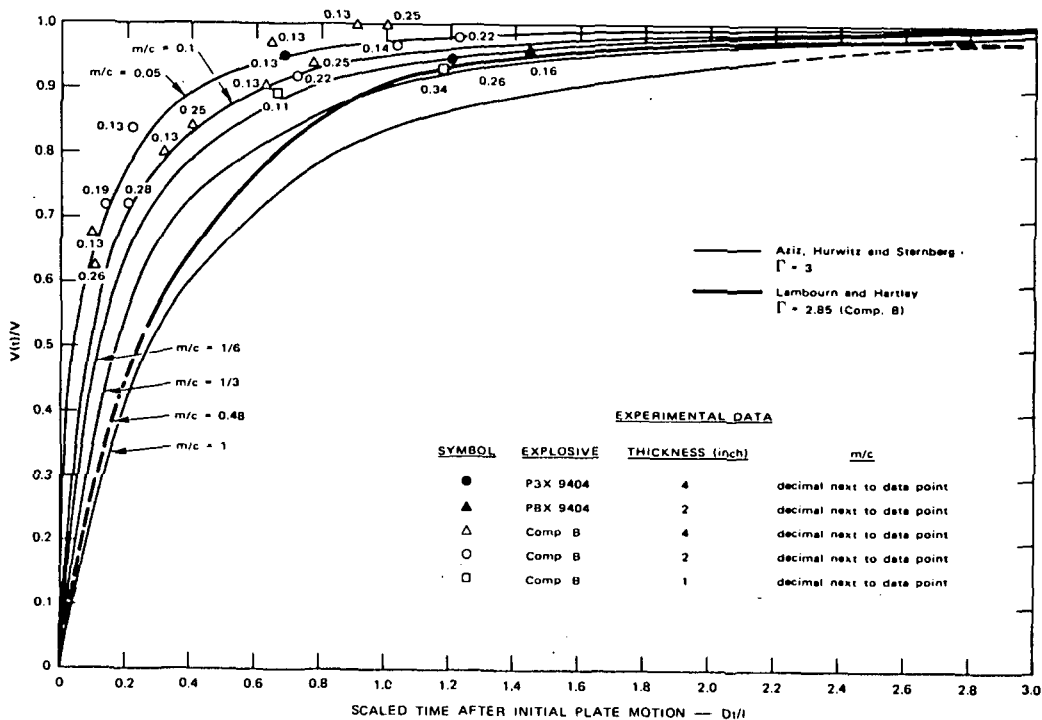

Fig 18 Theoretical and Experimental Plate Accelerations

0.6, which is certainly a lower limit estimate of the scaled time since we used V , and not $V(t) < V$, in estimating the flight time t . We can use this underestimated Dt/ℓ as a first approximation for the following iteration procedure. According to the theoretical curves of Fig 18, $V(t)/V = 0.85$ or $V(t) \sim 3 \mu\text{sec}$ at $Dt/\ell = 0.6$. Recomputing t , using $V(t) = 3 \text{mm}/\mu\text{sec}$, we get $Dt/\ell \approx 0.7$ for which $V(t)/V = 0.88$ and so on, until $V(t)/V$ no longer changes. This constant $V(t)/V$ is still an underestimate because we should use some average velocity from $t = 0$ to t and not $V(t)$. Let us assume that our iteration gives $V(t) \rightarrow 3.1 \text{mm}/\mu\text{sec}$ and that the rms velocity $3.1(\sqrt{2}/2) = 2.2 \text{mm}/\mu\text{sec}$, represents the average velocity from 0 to t . With these assumptions our best estimate of Dt/ℓ is about 0.92 for which the theoretical $V(t)/V$ is also about 0.92. However, the exptl data points of Fig 18 indicate that for $Dt/\ell \sim 0.9$, $V(t)/V$ is nearly unity; thus the pragmatic results (and to a lesser degree the theoretical results) justify our procedure of normalizing to a flight path of 1.5 inches

B. Terminal Velocities in 2-D Configurations

Hoskin et al (Ref 5) have examined the acceleration of a metal plate by a tangentially incident ("running") detonation. Their computational results suggest that at a distance from the detonation front equal to twice the expl thickness the plate has been accelerated to its terminal velocity

Kury et al (Ref 7) on the basis of theoretical considerations of 2-D detonations in metal cylinders, conclude that the terminal cylinder expansion velocity is reached after about a two-fold radial expansion. Their exptl results (Refs 7 & 13) for Comp B, HMX, and many HMX mixts justify this theoretical conclusion

VII. Estimation of the Impulse Distribution in the Expanding Detonation Products

Suppose we want to know the mass per unit area m_g , momentum $\Phi_g(x)$ of the detonation products expanding in the direction of the metal plate in a 1-D system. The Gurney assumption of linear distribution of gas velocities enables us to compute all these quantities. The derivations of the necessary equations are given in Appendix G. Here we present only the final results, namely:

$$m_g = \frac{c}{2(1 + m/c)} \quad (31)$$

$$\Phi_g = \frac{cV}{4} \left(\frac{1}{1 + m/c} \right) \quad (32)$$

$$\Phi_g(x) = \frac{cV}{4} \left(\frac{1}{1 + m/c} \right) \left(\frac{n^2 - 1}{n^2} \right) \quad (33)$$

where $x = x_0 + \ell - x_0/n$ in the coordinate system of the diagram of Appendix G

From Eqn (32), the ratio of gas impulse to plate impulse is:

$$\Phi_g/mV = \frac{1}{4} \left(\frac{c/m}{1 + m/c} \right) \quad (34)$$

This ratio is sensitive to variation in c/m in the sense that an increasing c/m increases the numerator and decreases the denominator. In the limit of $m/c \gg 1$, $\Phi_g/mV \approx \frac{1}{4}(c/m)^2$. Eqn (33) permits some interesting conclusions about the distribution of the gas impulse in the direction of the plate motion. If $n = 2$ (ie, we are considering one-half of the gas that moves in the plate direction), then $\Phi_g(x)/\Phi_g = 3/4$. If $n = 4$ (we are considering three-fourths of the gas that moves in the plate direction), then $\Phi_g(x)/\Phi_g = 15/16$ or nearly all of the gas momentum

Let L be the distance from the original location of the metal/expl interface to an immovable target. Then, according to Eqns (6)–(8) in Appendix G, $3/4$ of the total gas momentum will be delivered to the target in roughly $2L/V \mu\text{sec}$ (if L is in mm and V is in $\text{mm}/\mu\text{sec}$). Similarly $15/16$ of the gas momentum will be delivered in about $4L/V \mu\text{sec}$. These are crude estimates since they ignore the reverberations produced by the plate reflected from the target and the oncoming gases

If one makes the rather drastic assumption that the pressure distribution of the gas moving with the plate is linear (ie, like the gas velocity $u(x)$, the pressure is greatest next to the plate and decreases linearly to zero at x_0 where $v(x) = 0$), then:

$$\Phi_g = \int_0^\tau P dt = \frac{P_{\max} \tau}{2} \quad (35)$$

From the Gurney assumption of linear gas velocities, $v(x) = dx/dt = (V + U)x/\ell - U$ and in the coordinate system of Appendix G:

$$\int_0^{\tau} dt = \int_{x_0}^{\ell} \frac{dx}{\left[\frac{V+U}{\ell} \right] x - U}$$

We need to establish a cutoff for the lower limit of the right-hand integral, since at x_0 this integral becomes infinite. Suppose we choose the lower limit to be $x = x_0 + (\ell - x_0)/n$. Performing the integration with this lower limit we get:

$$\tau = \left(\frac{\ell}{V+U} \right) \ell n(n) = \left(\frac{\ell}{2V(1+m/c)} \right) \ell n(n) \quad (36)$$

and combining this result with Eqns (35) and (32) we obtain:

$$P_{\max} = \frac{cV^2}{\ell \ell n(n)}$$

If we assume that the plate immediately acquires its terminal velocity V , $\ell = h + t(V+U)$, where t is the time for the plate to reach the target, and:

$$P_{\max} = \frac{cV^2}{[h + 2Vt(1+m/c)] \ell n(n)} \quad (37)$$

Usually $2Vt(1+m/c) \gg h$ so that:

$$P_{\max} \approx \frac{cV}{2t(1+m/c) \ell n(n)} \quad (38)$$

For a practical situation of 90 mils of EL 506 driving a 16-mil Al plate and an observed time of $6\mu\text{secs}^*$ for the plate to reach the target, Eqn (38) gives:

$$P_{\max} \approx 1 \text{ kbar if } n = 100 \\ (\text{ie, } \Phi_g(x)/\Phi_g = 0.9999)$$

Upon reflection from a rigid wall, this pressure increases by a factor of about $(3\Gamma - 1)/(\Gamma - 1) = 4$ for $\Gamma = 3$

Another estimate of P_{\max} can be made on the basis of simple gas dynamics assuming that the detonation products are a polytropic gas. The appropriate equation (see Doering and Burkhardt (Ref 1a)) is:

$$P_{\max}/P_{\text{atm}} = 1 + \frac{\Gamma V}{c_0} \cdot \left[1 + \left(\frac{\Gamma+1}{4} \right) (V/c_0)^2 + \frac{\Gamma+1}{1} V/c_0 \right] \quad (39)$$

where we have taken the peak particle velocity in the gas to be V . For the case considered above, $V/c_0 \approx 7.3$ and $P_{\max} \approx 0.3\text{kbar}$ for $\Gamma = 3$. This constitutes a lower limit estimate of the gas pressure before it strikes the target, since the estimate ignores any pressure increase due to gas reflections at the plate

Additional correlation between explosively generated impulse and Gurney formulae is given in Vol 7, I58-R to I63-L

VIII. Applications

As already mentioned, the Gurney approach was originally developed to estimate bomb fragment velocities. Below we want to consider some alternate practical and theoretical applications on this versatile method

Benham and Matthews (Ref 20) used the Gurney approach to compute flyer plate velocities of plates propelled by a light-initiated expl. They present a curve that appears to indicate that $\sqrt{2E}$ is a function of c , the expl real density. This is, of course, contrary to a large body of data which shows that $\sqrt{2E}$ is solely a function of the type of expl used and *not* of its mass (per unit volume, area or length)

The writer (Ref 25) used an adaptation of the Gurney method to estimate max flyrock range of industrial blasts in open-pit mines. Hazardous flyrock is comparatively massive (big pebbles — not dust) but moves relatively slowly. Thus, air drag can be safely neglected. Consequently a simple ballistic trajectory calcn will establish max flyrock range. All that is required is a means of estimating initial flyrock velocity, since for the max range L_m , the initial angle of take-off must be 45° . Thus, $L_m = v_0^2/g$ (40) where g is the acceleration of gravity. Now v_0 can be obtained by the Gurney method as follows:

Consider an explosively-loaded borehole in a mass of rock as sketched in Figs 19 and 20. We shall only examine flyrock from the free face. Clearly $m/c \gg 1$, then from Eqn (5):

$$v_0 \approx \sqrt{2E'} \sqrt{c/m} \quad (41)$$

and from the geometry of Fig 14:

$$c/m = \frac{W/\ell}{\rho_m b^2 \tan(\alpha/2)} \quad (42)$$

* Taken from an experiment by J.D. Colton (private communication)

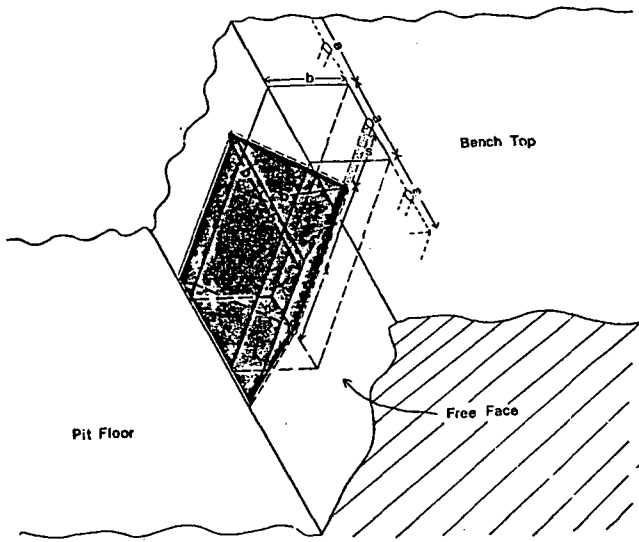

Fig 19 Three-Dimensional View of a Bench Blast

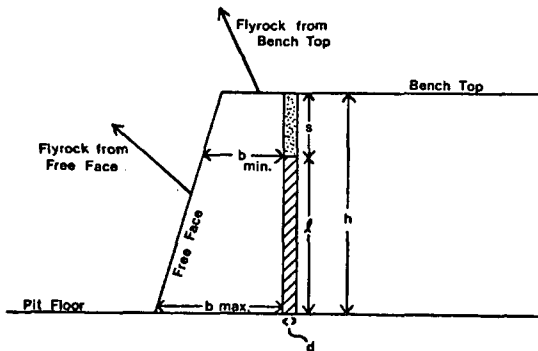

Fig 20 Plan View of a Bench Blast

where w/l is the expl weight per unit length of loaded borehole, b is the distance of the borehole to the free face, commonly known as "burden", and α is the prism apex angle at the borehole. Experience shows that $\alpha \approx 90^\circ$, therefore $\tan(\alpha/2)$ is usually unity

As shown in Section II and Eqn (16), $\sqrt{2E'}$ can be expressed in terms of D and Γ . For many expls at packing densities in excess of 1 g/cc, $v_0 \approx D/3\sqrt{c/m}$, but for ANFO, (primarily because of its low packing density) $v_0 \approx 0.44D\sqrt{c/m}$

Now Eqn (41) predicts that a plot of v_0^2 vs c/m should be a straight line thru the origin. As shown in Ref 25, actual flyrock velocity data (squared) plotted vs computed c/m (Eqn (42))

does indeed follow a straight line, but this line has a *negative* intercept, and its slope is slightly different from the expected $2E'$. The explanation of these discrepancies lies in the neglect of any energy-absorbing steps in Eqn (41). Obviously, this is an oversimplification since rock fracture consumes some of the available chemical energy of the expls. Similarly, generation of seismic waves in the rock, and the formation of the crushed rock zone immediately around the borehole also consume energy. Rock breakage (at least most of the breakage), seismic wave generation and crushed zone formation are substantially complete before the breakout rock mass attains the velocity v_0

For a given homogenous rock blasted with a given expl, one might expect that the:

- 1) energy consumed in rock fracture is proportional to m ;
- 2) seismic energy is proportional to c ; and
- 3) energy to and from the crushed zone is proportional to c .

Assumptions 2 and 3 are fully justified in the literature. Assumption 1 is more difficult to justify. The energy to fracture homogeneous rock should really be proportional to the number of fragments into which the mass of rock breaks, or more properly to the new surfaces created by fracture. However, inter-fragment friction during break-up and possibly plastic deformation of the fragmented material will also absorb energy. If fracture produces approximately equidimensional fragments, assumption 1 is valid. If the number and size of fragments varies greatly with shot dimensions (even though a given expl is used to blast a given rock mass), assumption 1 is invalid. In the limit of large burdens and small charges it is known that shots break rock into large chunks or slabs, whereas under normal production blasting, rock is fragmented into many roughly equidimensional pieces. Clearly, assumption 1 can be valid only over a limited range of m/c . Hopefully, it is valid over the "normal" range of m/c in production blasting

Taking into account the above energy losses leads to:

$$cE' - c(K_1W_s + K_2W_c) - m(K_3W_r) \approx \frac{1}{2}mv_0^2$$

where W_s = seismic energy generated by a unit weight of expl

W_c = energy to crush a unit weight of rock

W_r = energy absorbed in breaking out a unit weight of rock

K_1, K_2, K_3 are proportionality constants, and:

$$v_0^2 \cong 2E'(c/m) - 2K_3W_r - 2(K_1W_s + K_2W_c)c/m$$

or

$$v_0^2 \cong 2E'(c/m) \left[1 - \frac{K_1W_s + K_2W_c}{E'} \right] - 2K_3W_r \quad (43)$$

According to Eqn (43), a plot of v_0^2 vs c/m should give a straight line of slope $2E' [1 - (K_1W_s + K_2W_c)/E']$ and intercept of $-2K_3W_r$. In general, the negative term (within the brackets) is considerably smaller than one, and available a priori estimates of the magnitude of $2K_3W_r$ are consistent with the values obtained from intercepts of v_0^2 vs c/m plots

Max flyrock ranges computed via Eqns (43) and (40) agree quite well with observed flyrock ranges, when one considers that observed ranges can be:

- 1) Not max ranges;
- 2) Flyrock may originate from bench tops and not the free face; and
- 3) "Wild" flyrock

Wild flyrock, ie, flyrock that travels much farther than expected, can result from:

- 1) holes loaded almost to the top;
- 2) greatly decreased burden due to cavities ("vugs") in the free face; and
- 3) internal cavities and/or intersecting weakly adherent regions such as mud seams

To sum up, the Gurney approach provides reliable max flyrock ranges for flyrock from free faces. Although a similar treatment can be used to estimate max flyrock ranges from bench tops (see Ref 25), these estimates are less reliable because of uncertainties in computing c/m for these systems

One of the big unresolved problems in detonation physics is that of the isentropic expansion of detonation products; ie, there exists no completely acceptable relationship between expansion volume and pressure. Henry (quoted in Ref 27) assumed that detonation products expand radially with a linear velocity gradient. He also assumed a polytropic EOS with $\gamma = 3$ (Γ in our notation) and that a cylindrically-loaded steel casing bursts at $R/R_0 = 1.2$. At large R the casing approaches its full Gurney velocity, which

leads to the following expression for pressure: $P_0 = (\gamma - 1)\rho_e E / (1 + 1/2c/m)$ where E is the Gurney constant

Kury et al (Ref 7) claimed that cylinder expansion cannot be represented by an EOS using a constant γ . Regardless of the merits of their claim, they have obtained what appear to be the best measurements of instantaneous cylinder expansion velocity

Recently Kornhauser (Ref 27) set out to improve the Henry approach. His basic assumptions were:

"(1) At the end of the detonation process, the gas is assumed to be at a constant (spacewise) pressure, P_1 .

(2) The velocity distribution in the gas is assumed to vary linearly from zero at $R=0$ to casing velocity V_1 at $R=R_1$.

(3) The casing's initial velocity after detonation, V_1 , is consistent with empirical data."

Of the above assumptions, only the last can be verified directly by comparison with exptl data. However, since that comparison will be correct at the end of detonation and since the other assumptions are made consistent with the observed Gurney velocity at the end of casing expansion, he suggests that the casing motions in between will also be fairly well represented

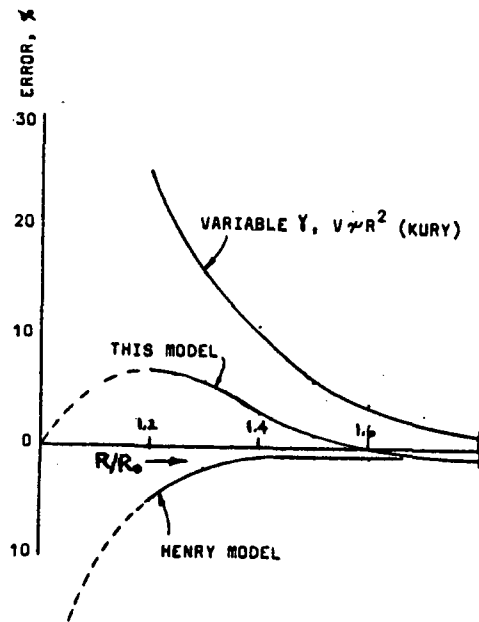

Fig 21 Predictive Accuracies of Models

In summary, the predictive values of the three models are estimated by plotting the % errors in computed velocities (with reference to measured velocities) vs the expansion ratio R/R_0 . As shown in Fig 21, not unexpectedly, Kornhauser's model comes out best in his evaluation

On several occasions we have referred to the studies of Defourneaux and co-workers. Their method (see Ref 12) of obtaining plate velocity consisted of radiographic *measurements* of plate deflection angle and computation of plate velocity from geometric considerations. Utkin et al (Ref 22) attempted to compute this deflection angle by an approximate a priori calcn. Unfortunately their paper is difficult to follow, and although agreement with expt is claimed, such agreement is not discernible from their publication. A cursory examination by the writer suggests that their computed deflection angles are considerably too low

Written by J. ROTH

Appendix A Effect of Air at Free Boundary

The following is an adaptation of a derivation given by Deal. The system considered is identical to that discussed in Section II-A except that the expl is bounded on one side by air rather than by a vacuum. The subscript "a" will be used to designate the particle velocity and density in shocked air

Eqn (1) becomes

$$u_J \pm \int_0^{\rho_J} c \frac{d\rho}{\rho} = u_a \pm \int_0^{\rho_a} c \frac{d\rho}{\rho} \quad (\text{A-1})$$

$$\text{or } u_a + u_J = -\frac{2}{\Gamma - 1} (c_J - c_a)$$

$$= -\frac{2\sqrt{\Gamma}}{\Gamma - 1} \left[\left(\frac{P_J}{\rho_J} \right)^{\frac{1}{2}} - \left(\frac{P_a}{\rho_a} \right)^{\frac{1}{2}} \right] \quad (\text{A-2})$$

for a polytropic gas

$$P_a/\rho_a = P_J/\rho_J (\rho_a/P_J)^{\Gamma-1}$$

and Eqn (A-2) becomes

$$u_a + u_J = -\frac{2\sqrt{\Gamma}}{\Gamma - 1} \left[\frac{P_J}{\rho_J} \right]^{\frac{1}{2}} \left[1 - (\rho_a/\rho_J)^{\frac{\Gamma-1}{2}} \right] \quad (\text{A-3})$$

For a C-J detonation whose products behave as a polytropic gas

$$\left[\frac{P_J}{\rho_J} \right]^{\frac{1}{2}} = u_J \sqrt{\Gamma}$$

and Eqn (A-3) becomes

$$u_a - u_J = -2u_J \left[\frac{\Gamma}{\Gamma - 1} \right] \left[1 - (\rho_a/\rho_J)^{\frac{\Gamma-1}{2}} \right] \quad (\text{A-4})$$

and

$$\begin{aligned} u_a &= -u_J \left[\frac{\Gamma + 1}{\Gamma - 1} \right] \left[1 - \frac{2\Gamma}{\Gamma + 1} (\rho_a/\rho_J)^{\frac{\Gamma-1}{2}} \right] \\ &= -\frac{D}{\Gamma - 1} \left[1 - \frac{2\Gamma}{\Gamma + 1} (\rho_a/\rho_J)^{\frac{\Gamma-1}{2}} \right] \end{aligned} \quad (\text{A-5})$$

For $\rho_a \rightarrow 0$, ie, for vacuum, Eqn (A-5) reduces to Eqn (4) of Section II

To evaluate Eqn (A-5), assume $\rho_a = 10\rho_{\text{air}} = 0.016\text{g/cc}$, where ρ_{air} is the density of unshocked air at 25°C and 1 atm. For polytropic detonation products $\rho_J = [(\Gamma + 1)/\Gamma] \rho_0$, where ρ_0 , the initial density of the expl, is assumed to be 1.6 g/cc

If we call the terminal plate velocity of a system bounded by vacuum, V_1 , and a system bounded by air, V_2 , then at a fixed m/c , according to Eqn (14), and Eqn (A-5)

$$\begin{aligned} V_2/V_1 &= 1 - \frac{2\Gamma}{\Gamma + 1} (\rho_a/\rho_J)^{\frac{\Gamma-1}{2}} \\ &= \sqrt{2E_2}/\sqrt{2E_1} \end{aligned} \quad (\text{A-6})$$

With the above assumptions about ρ_a and ρ_J , Eqn (A-6) gives

$$V_2/V_1 = \sqrt{2E_2}/\sqrt{2E_1} = 0.989 \text{ for } \Gamma = 3$$

$$V_2/V_1 = \sqrt{2E_2}/\sqrt{2E_1} = 0.978 \text{ for } \Gamma = 2.6$$

$$V_2/V_1 = \sqrt{2E_2}/\sqrt{2E_1} = 0.891 \text{ for } \Gamma = 2.0$$

Appendix B Effect Of A Rigid Wall

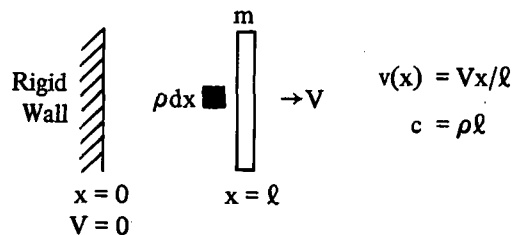

$$\text{Gas KE} = \frac{1}{2} \int_0^{\ell} v^2(x) \rho dx = \frac{(1/6) \rho \ell V^2}{(c/6) V^2}$$

$$\text{Total KE} = \frac{1}{2} m V^2 + (c/6) V^2 = CE$$

$$\text{or } V = \sqrt{2E} (m/c + 1/3)^{1/2}$$

Appendix C

Constancy of the Ratio

$$\frac{1 + 5m/c + 4(m/c)^2}{3(1 + 2m/c)^2} = A^2$$

From Eqn (7) with $m/c = x$

$$3A^2 = \frac{1 + 5x + 4x^2}{(1 + 2x)^2} = 1 + \frac{x}{(1 + 2x)^2} \quad (C-1)$$

According to Eqn (C-1), $3A^2 = 1$ at $x = 0$ and at $x = +\infty$. Between these two extremes of x there may be maxima or minima in the value of A . Of course A has to be positive for all values of x . Differentiating (C-1) and setting the differential equal to zero, we get

$$1 - 2x = 0 \quad \text{or} \quad \text{the max value of } A \text{ occurs at } x = \frac{1}{2}$$

Thus a single maximum occurs at $x = \frac{1}{2}$, and $3A^2$ changes from 1 to $1 + 1/8$ to 1 in a continuous manner as x goes from zero to $\frac{1}{2}$ to $+\infty$. The maximum value of $\sqrt{3A} = \sqrt{9/8} = 3/2 \sqrt{2} =$

1.061 and $A_{\text{max}} = 0.6124$ and $\bar{A} = 0.591$ for $0 < x \leq 12.5$, or $\bar{A} = 0.590$ for $0.5 \leq x \leq 12.5$ or $\bar{A} = 0.609$ for $0.3 \leq x \leq 2$. Thus the max difference between A_{max} and \bar{A} is less than 4%. The smallest value of A (at $x = 0$ or $x = \infty$) is 0.577

Appendix D

Derivation of Gurney Formula for a A Semiinfinite Slab; 2-D Configuration

In any horizontal section (such as the one indicated by the broken line in the sketch), let ℓ be the distance from the detonation products/vacuum boundary to the metal plate. For any such horizontal section, the equations developed in Appendix B will hold if x is set equal to zero at the detonation products-vacuum boundary.

Thus
$$V = \frac{U}{1 + 2m/c} \quad (D-1)$$

Products Kinetic Energy =
$$\rho \int_0^{\ell} \left[\left(\frac{V+U}{\ell} \right) x^2 - U - u(y) \right]^2 dx \quad (D-2)$$

Then as in Eqns (B-4) and (B-5)

Total Kinetic Energy =
$$\frac{1}{2} m V^2 + c/6 [V^2 + U^2 - UV + 3u^2(y)] \quad (D-3)$$

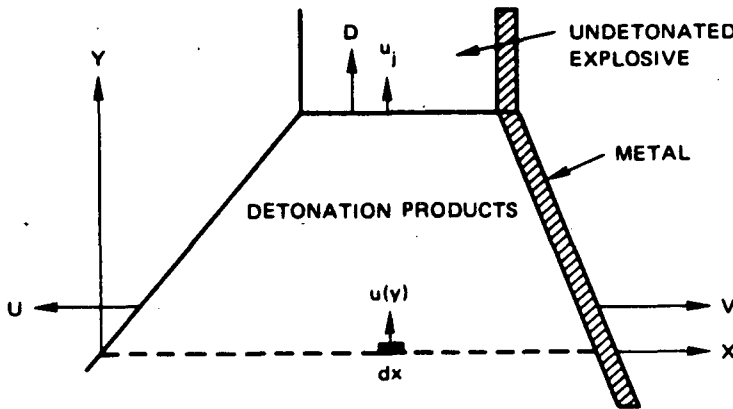

- c = Mass/Area of Unexploded High Explosive (HE)
- m = Mass/Area of Metal
- ρ = Products Density = Constant

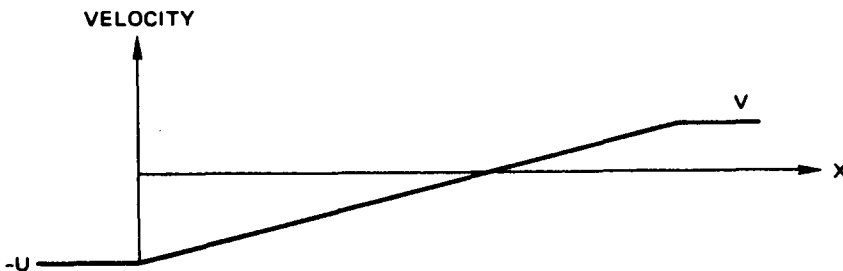

Table E-1
Gurney Constants, $\sqrt{2E}$, for 1-D Systems

Driver Explosive		PWG ^a Equiv =		V		$\sqrt{2E}$		Normalized $\sqrt{2E}$ ^b	
Type	Thickness (inches)	No. of Obs	L (inches)	m/c ^a Range	Range (mm/ μ sec)	Average (mm/ μ sec)	Range (mm/ μ sec)	Average ^c (mm/ μ sec)	Range (mm/ μ sec)
PBX 9404	6 ^d	5	0.4	0.095-0.142	4.21-4.60	3.19	3.11-3.26	3.27	3.21-3.36
PBX 9404	4	23	0.4	0.015-0.193	3.85-4.53	3.24	3.08-3.36	3.30	3.17-3.43
PBX 9404	3	10	0.4	0.102-0.252	3.48-4.37	3.21	3.12-3.28	3.28	3.21-3.38
PBX 9404	2	2	0.4	0.157	3.94-3.97	3.13	—	3.23	—
PBX 9404	4	6	0.4	0.210-0.262	3.28-3.52	3.08	—	3.08 ^c	—
PBX 9404	2	3	0.4	0.252	3.23-3.28	2.99	2.96-3.02	3.08 ^c	3.05-3.11
Overall Avg $\sqrt{2E} = 3.28$ (mm/ μ sec)									
Comp B	6 ^d	6	0.8	0.095-0.183	3.50-4.03	2.84	2.77-2.89	40 obs (3.17-3.43) mm/ μ sec	2.85-2.98
Comp B	4	19	0.8	0.133	3.65-3.91	2.85	2.75-2.94	2.91	2.81-2.94
Comp B	3	5	0.8	0.162	3.54-3.70	2.86	2.82-2.95	2.87	2.82-2.95
Comp B	2	13	0.8	0.220-0.426	2.40-3.32	2.80	2.71-2.89	2.86	2.76-2.92
Overall Avg $\sqrt{2E} = 2.87$ (mm/ μ sec)									
TNT	6 ^d	3	1.0	0.100-0.119	3.29-3.47	2.45	2.43-2.48	43 obs (2.76-2.98) mm/ μ sec	2.50-2.55
TNT	2	1	1.0	0.206	2.86	2.47	—	2.52	—
Overall Avg $\sqrt{2E} = 2.53$ (mm/ μ sec)									
PBX 9205	6 ^d	2	0.6	0.0504-0.101	0.0504-0.101	2.97	2.82-3.12	4 obs (2.50-2.55) mm/ μ sec	2.90-3.21
PBX 9010	6 ^d	1	0.6	0.157	3.04	—	—	3.06	—
Baratol	2	10	2 (?)	0.109-0.123	1.96-2.35	—	—	3.13	—
Baratol	—	—	4 (?)	0.109-0.123	1.96-2.35	—	—	1.62	1.47-1.71
Overall Avg $\sqrt{2E} = 2.53$ (mm/ μ sec)									
Overall Avg $\sqrt{2E} = 2.53$ (mm/ μ sec)									

a) See discussion in Section IV-A

b) Normalized to a flight path of 1½ inches

c) Omitting values marked c; all the systems marked c had a 1/8-inch air gap between the driver expl and the driver plate

d) LRL data

Equating the total kinetic energy to the Gurney energy of the expl gives

$$cE = \frac{V^2}{2} \left[\left(\frac{1}{3} + \frac{5}{3} \right) \left(\frac{m}{c} \right) + \frac{4}{3} \left(\frac{m}{c} \right)^2 \right] + \frac{u^2}{2} (y) \quad (D-4)$$

or

$$V = \sqrt{2E - u^2(y)} \left[\frac{3}{1 + 5m/c + 4(m/c)^2} \right]^{1/2} \\ = \sqrt{2E} \sqrt{1 - u^2(y)/2E} \left[\frac{3}{1 + 5m/c + 4(m/c)^2} \right]^{1/2} \quad (D-5)$$

Appendix E
Computation of $\sqrt{2E}$

In Table E-1 we present details of our computation of $\sqrt{2E}$ from plate velocity data. All these data, except for the 6-inch-thick slabs are from SRI sources. The six-inch slab data are from LRL (W.H. Gust private communication)

Appendix F
Gurney Constant for Explosive-Inert Mixtures

The LRL data for HMX-inert mixtures is for cylinders at a $c/m \approx 1/2$. For cylinders the Gurney formula is

$$V = \sqrt{2E'} \left[\frac{c/m}{1 + (1/2)(c/m)} \right]^{1/2} \quad (F-1)$$

If we assume that the "inert" does not contribute to the metal cylinder acceleration,

$$V = \sqrt{2E'_E} \left[\frac{c_E/m}{1 + (1/2)(c_E/m)} \right]^{1/2} \quad (F-2)$$

where all quantities with a subscript E are for the expl component of the mixture. Equating (F-1) and (F-2) we obtain

$$\sqrt{2E'} = \sqrt{2E'_E} \left[\frac{c_E}{c} \right]^{1/2} \left[\frac{1 + (1/2)(c/m)}{1 + (1/2)(c_E/m)} \right]^{1/2} \\ \approx \sqrt{2E'_E} \sqrt{\theta_E} \quad (F-3)$$

Since the term $\left[\frac{1 + (1/2)(c/m)}{1 + (1/2)(c_E/m)} \right]^{1/2} \approx 1$, $\sqrt{\theta_E} \approx \sqrt{c_E/c}$

Appendix G
Gas Momentum

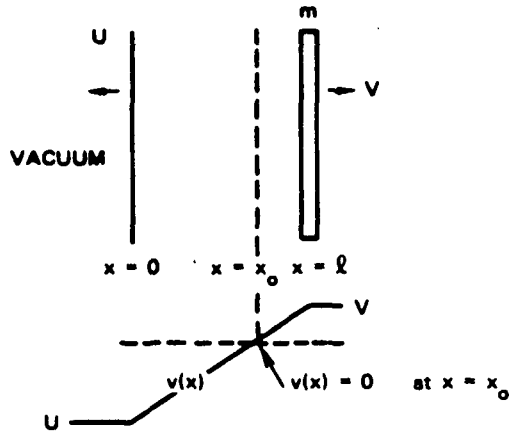

- Conservation of mass $\rho l = c$
- Gurney Assumption $v(x) = (V + U)(x/l) - U$
- Conservation of Momentum $U = (1 + 2m/c)V$
and $V + U = 2V(1 + m/c)$

for $v(x) = 0$ according to the Gurney assumption
 $(V + U)x_0/l - U = 0$ or
 $x_0/l = U/(V + U) \quad (G-1)$

If m_g is the mass per unit area of products in the direction of V, then

$$m_g = \int_{x_0}^l \rho dx = \rho(l - x_0) = \rho l(1 - x_0/l) \\ = c \left(1 - \frac{U}{V + U} \right) = \frac{c}{2(1 + m/c)} \quad (G-2)$$

If Φ_g is the momentum of product gas in the direction of V, then

$$\Phi_g = \int_{x_0}^l \rho v(x) dx = \rho \int_{x_0}^l \frac{V + U}{l} x dx - \rho \int_{x_0}^l U dx \\ = \rho \left\{ \frac{V + U}{2l} x^2 \right\}_{x_0}^l - Ux \Big|_{x_0}^l \\ = \rho l \left\{ \frac{V + U}{2} - U - \frac{V + U}{2} \left(\frac{x_0}{l} \right)^2 + U \frac{x_0}{l} \right\} \quad (G-3)$$

$$= c \left\{ \frac{V - U}{2} - \frac{U^2}{2(V + U)} + \frac{U^2}{V + U} \right\} \text{ from Eqn (G-1)} \\ = \frac{c}{2} \left\{ V - U + \frac{U^2}{V + U} \right\} = \frac{cV}{2} \left[\frac{V}{V + U} \right] = \frac{cV}{4} \left[\frac{1}{1 + m/c} \right] \quad (G-4)$$

Since the momentum of the plate is mV

$$\Phi_g/\Phi_m = \frac{c}{4m} \left[\frac{1}{1+m/c} \right] = \frac{1}{4} \left[\frac{c/m}{1+m/c} \right] \quad (G-5)$$

For large c/m

$$\Phi_g/\Phi_m \rightarrow \frac{1}{4} c/m$$

and for small c/m

$$\Phi_g/\Phi_m \rightarrow \frac{1}{4} (c/m)^2$$

For any $x_0 < x < \ell$

$$\Phi_g(x) = c \left[\frac{V-U}{2} - \frac{V+U}{2} \left(\frac{x}{\ell} \right)^2 + U \frac{x}{\ell} \right] \quad (G-6)$$

Let $x = x_0 + (\ell - x_0)/n$ where n is any real positive number greater than zero

$$x/\ell = \frac{1}{n} \left[(n-1) x_0/\ell + 1 \right] = \frac{1}{n} \left[\frac{V+nU}{V+U} \right] \quad (G-7)$$

Substituting (G-7) into (G-6) and simplifying gives

$$\Phi_g(x) = \frac{cV}{4} \left[\frac{1}{1+m/c} \right] \left[\frac{n^2-1}{n^2} \right] \quad (G-8)$$

$$\begin{aligned} v(x) &= (V+U) x/\ell - U \text{ which according to (G-7)} \\ &= \frac{V+nU}{n} - U = V/n \end{aligned}$$

For a distance L from an unexploded metal-expl interface to a target, the time of delivery of any portion of the gas impulse is approximately

$$\frac{L}{V/n} = nL/V \quad (G-9)$$

Refs: 1) R.W. Gurney, BRL Rept 405 (1943)
 1a) W. Doering & G. Burkhard, AMC A9-T-46 (1946), 42 2) R. Courant & K.O. Friedrichs, "Supersonic Flow and Shock Waves", Vol 1, 87-88 (1948) 3) A.K. Aziz et al, PhysFluids 4, 380 (1961) 3a) J.K. Crosby, SRI Internal Rept No 019-61, Stamford Res Inst (1961)
 4) G.R. Abrahamson, Ibid No 009-62 (1962)
 5) N.E. Hoskin et al, 4th DetonSymp, 14 (1965)
 6) B.D. Lambourn & J.E. Hartley, Ibid, 538 (1965) 7) J.W. Kury et al, Ibid, 3 (1965)
 8) D. Randall et al, AFATL-TR-67-193 (1967)
 9) S. Abarbanel & G. Zwas, JMathAnalysis& Applications 28, 517 (1969) 10) D.R. Kennedy, Proc 21st Annual Mtg, American Ordn Assn (1969) 11) J.E. Kennedy,

SC-RR-790, Sandia Labs (1970) 12) M. Defourneaux & L. Jacques, 5th DetonSymp, 457 (1970) 13) M. Finger et al, Ibid, 137 (1970) 13a) W.C. Davis & D. Venable, Ibid, 13 (1970) 14) J. Roth, SRI Lab Tech Rept 001.71, Stanford Res Inst (1971)
 15) J. Hershkowitz & J. Rigdon, PATR 4611 (1974) 16) S.J. Jacobs, NOL-TR-74-86 (1974) 17) J. Hershkowitz & I. Akst, 6th DetonSymp, 439 (1976) 18) M. Finger et al, Ibid, 732 (1976) 19) D.R. Hardesty & J.E. Kennedy, Combustn&Flame 28, 45 (1977)
 20) R.A. Benham & F.H. Mathews, SC-78-1535C, Sandia Labs (1978) 21) G.E. Jones, JAppl-Phys 50, 3746 (1979) 22) A.V. Utkin et al, FizGorVzryva 15, 101 (1979) 23) M.J. Kamlet & M. Finger, Combustn&Flame 34, 213 (1979) 24) Y.E. Charron, NTIS ADA 74759 (1979) 25) J. Roth, Minutes 19th Expl Safety Seminar, DDESB (1980), 265 26) N.E. Hoskin & B.D. Lambourn, Preprint 7th Deton-Symp, 743 (1981) 27) M. Kornhauser, Ibid, 756 (1981) 28) I.B. Akst, Ibid, 289 (1981) 29) B.M. Dobratz, "LLNL Explosives Handbook", UCRL-52997, Lawrence Livermore Lab, Univ Calif (1981)

Velocity, Particle

I. Introduction

Particle velocity (also called mass or material velocity) is an important detonation parameter. Previous Vols of the Encyclopedia contain frequent refs to particle velocity but no single comprehensive treatment. Mostly, such prior descriptions are found in articles on important expls, eg, PETN, RDX, TNT, etc. In addition, some particle velocity data and background is given in Vol 4, D466-67, D531 & D603-07; Vol 7, H179-83 & L32; Vol 9, S76 & T209-11. It is the purpose of the present article to bring together and update information on particle velocity in *steady and incipient detonations*. Particle velocity associated with shocks in non-expl materials will also be considered. Applications of particle velocity data will be described in Section II. Section III will be devoted to techniques of measuring particle velocity. Theoretical estimates of particle velocity and other theoretical considerations will be examined in Section IV, an refs to the literature will be presented in Section V

II. Applications

As discussed in the next section, there are several techniques for measuring *particle velocity*, which is usually designated as u or sometimes as u_p . Consequently, since U , the *shock velocity* (or D if the shock is a detonation, ie, a chemically supported shock) is readily measurable, most measurements of shock pressure P are based on measurements of particle velocity and the relation:

$$P = \rho_0 u U \quad (1)$$

where ρ_0 is the initial density. Similarly the specific volume v , of a shocked material is obtained via:

$$v = v_0 (1 - u/U) \quad (2)$$

where v_0 is the specific volume of the unshocked material

For strong shocks, the difference in specific internal energies of shocked and unshocked materials is expressed by:

$$\begin{aligned} e - e_0 &= \frac{1}{2} P (v_0 - v) \text{ and from Eqs 1 \& 2} \\ e - e_0 &= u^2/2 \end{aligned} \quad (3)$$

Of course, the famous Chapman-Jouguet condition also involves u , namely:

$$D = u + c \quad (4)$$

where c is the local sound velocity. From the above it is readily apparent that exptly measured values of u can then provide information on many detonation or inert shock parameters. Conversely, comparison of measured particle velocities with those theoretically calcd can furnish some degree of validation of the theoretical equation of state used in the calcs

Particle velocity is an important parameter in the so-called *impedance-mismatch* method of determining whether the shock from one material enters as a shock or rarefaction into another material in contact with the first material (see Vol 7, H179-83 and Vol 9, S60). Two of the three commonly used Hugoniot curves (see Vol 7, H179-83) are in the form of P vs u or U vs u plots, and the third form, P vs v , depends on v , usually obtained via Eq 2 (see Vol 7, H180)

The writer has suggested that input shock particle velocity is a better criterion for the shock sensitivity threshold of expls than input shock pressure (see Vol 9, S76)

In air blast phenomena, an important consideration is the dynamic pressure, q . It is defined by:

$$q = \rho u^2/2 \quad (5)$$

where ρ is the density behind the shock front

Multiple particle velocity gages imbedded in an expl can be used to obtain information on the hydrodynamics of the shock initiation process and to determine the energy release rate at and behind the initiating shock wave. More details on this technique will be presented in Section IV

III. Measurement Methods

At present there are three basic techniques of measuring particle velocity, namely: *free surface velocity* (FSV) measurements, *electromagnetic velocity* (EMV) measurements, and *flash X-ray* measurements. Before proceeding to describe these techniques, it should be noted that agreement among these techniques is not satisfactory. At present there is no consensus as to which technique is "best", nor is there any real understanding as to why these different methods give different results

FSV Method

Measurement of free surface velocity is the oldest and until recently the most widely used

technique of measuring particle velocity. This technique also requires a (preferably simultaneous) measurement of shock velocity. The technique's *idealized* rationale is represented graphically in Fig 1. Measurement of the FSV provides the point labeled u_{fs} . Shock velocity measurement (U_1) gives the line I of slope $\rho_0 U_1$ thru the origin of the P-u space. The intersection of the mirror image of line I, drawn thru the point u_{fs} (line II) with line I gives the desired particle velocity u_1 . This idealization is very close to reality for shocks in *non-porous* materials in which shocking *does not* produce any *phase changes*. For porous materials and materials undergoing phase changes the scheme of Fig 1 leads to erroneous results

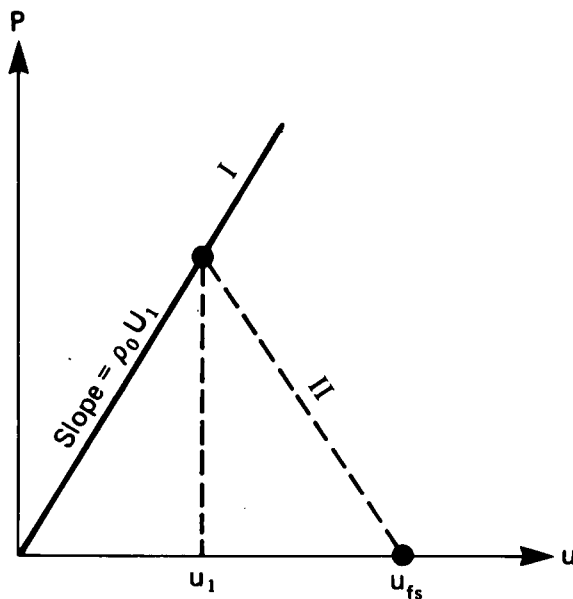

Fig 1 Schematic for Determining Particle Velocity from Free Surface Velocity Measurements

Various means have been employed to measure shock and free surface velocities. We quote from Ref 7: "The earliest work employed a pin technique. Pointed metal pins were spaced at graded distances from the free surface. When the surface was impelled forward by the impacting shock front, it made contact with each of the pins in turn. The pins were wired to separate pulse-forming circuits, and the pulses produced on contact were displayed on a high-speed oscilloscope sweep. In this way the free surface velocity

was measured. To determine shock velocity, small wells were drilled at various depths in the surface of the plate and in each well a pin was placed almost in contact with the bottom surface. Thus, as the shock wave arrived at each of these points (before reaching the main free surface) it caused a contact to be made almost instantly. In this way the shock wave velocity was measured inside the metal plate within a short distance of the free surface. What is desired is an instantaneous reading of shock velocity at the surface. Since the shock is constantly attenuating (a typical rate of attenuation 0.5 in. from the explosive/metal interface is 10 percent per in.), it is necessary to have velocity measurements within a few tenths of a millimeter of the surface. The technique, therefore, requires the utmost precision in machining the test specimens. Nonplanarity in the detonation front can also lead to serious errors. Work in this field, therefore, represents the culmination of patient effort in a most demanding endeavor.

Another means to measure shock and free-surface velocities is the "Lucite wedge" technique illustrated in Fig. 5-12(A). A flat-bottom groove is milled in the form of a ramp, making an angle of 10° with the metal surface. One end of a Lucite rod of rectangular cross section is placed in the ramp and the other end extending about an equal distance beyond, forming a wedge-shaped space between the rod and the metal surface. The Lucite rod does not rest directly on the metal surface in the ramp but is shimmed up so that there is a narrow gap between. Likewise, a thin metal sheet is placed over the under surface of the overhanging portion of Lucite and separated by shims so as to form a narrow gap at the surface of this portion of the rod. The gap under the Lucite rod is filled with argon. When the argon is suddenly compressed because of the movement of metal beneath, it flashes brightly. A streak camera is set up with the slit parallel to the long axis of the Lucite rod; a photograph like that shown in Fig. 5-12(B) is obtained. This yields the shock velocity and the free surface velocity on the same photograph. In later work it was found that a coating of paint filled with "microballoons" (very tiny, hollow plastic spheres) could be substituted for the argon-filled gap with equal effect.

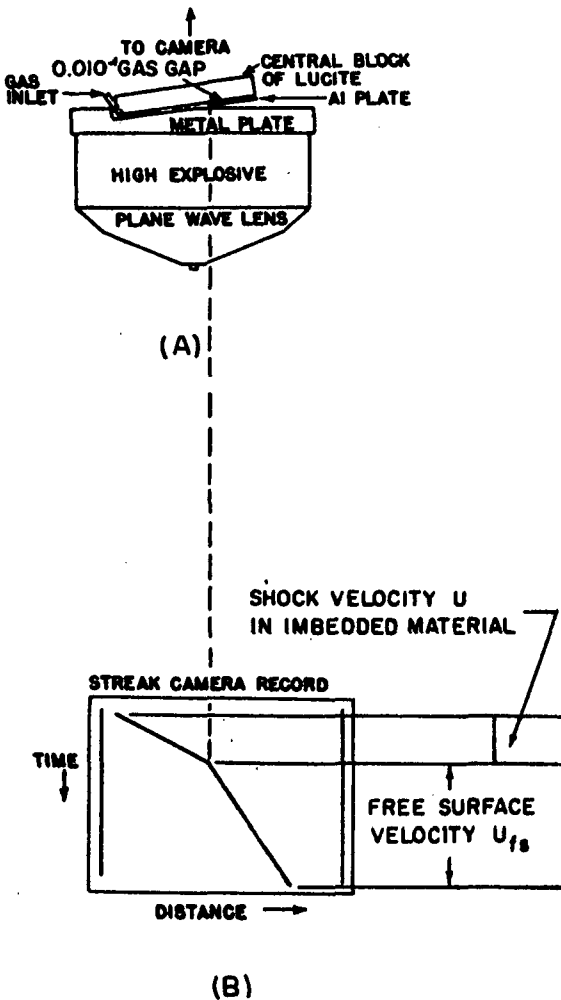

Fig 5-12 "Wedge" Technique for Measuring Free-Surface Velocity and Shock Velocity

A third method for measuring velocities employs Lucite and argon gaps in a similar way but does not use the wedge. Instead, the free-surface velocity is measured across a fixed gap between a Lucite block and the metal surface. Shock velocities are measured by attaching small metal blocks of various thicknesses to the surface of the main plate and recording the transit time of the shock wave in each by the argon-gap method."

A more recent technique utilizes laser interferometry. Again we quote from Ref 7: "With the interferometer, the movement of a reflecting surface can be monitored as a function of time. The surface can be a free surface or in transparent materials a reflecting plane within or

between two specimens. The Faraday foil technique provides a measurement of particle velocity in nonconductors. These two techniques are described here briefly. More detailed information can be found in the references.

The laser interferometer is shown schematically in Fig. 5-13. The parameter measured is the free surface velocity of the specimen material. The principle of operation is as follows. Light from the single frequency gas laser is focused on the surface of the target by means of a lens L1. The reflected light is recollimated by L2, and then split by a beam splitter B1. Half the light traverses the delay leg and is recombined with the undelayed half at beam splitter B2. The photomultiplier then records a signal whose brightness depends on the relative phases of the two beams. Since the delay leg is fixed and the wavelength of the input light is a function of free surface velocity (Doppler shift), the number of fringes recorded at the photomultiplier is related to the free surface velocity. The relationship can be derived as follows. The Doppler shift is given by

$$\Delta\lambda(t) = -\left(\frac{2\lambda}{c}\right)u(t) \quad (5-9)$$

where λ is the wavelength, c the speed of light, and $u(t)$ is the speed of the reflecting surface at time t . The delay leg length $N\lambda$ is

$$N\lambda = c\tau \quad (5-10)$$

where τ is the time for light to traverse the delay leg. Differentiating Eq. 5-10 gives

$$\Delta N(t) = -\left(\frac{c\tau}{\lambda^2}\right)\Delta\lambda(t) \quad (5-11)$$

and substituting for $\Delta\lambda$ in Eq. 5-9 from Eq. 5-11 gives

$$u(t) = \left(\frac{\lambda}{2\tau}\right)\Delta N(t) \quad (5-12)$$

The number of fringes ΔN as a function of time are thus related to the reflecting surfaces velocity by a constant $\lambda/(2\tau)$.

The major advantages of the laser interferometer over previous free surface systems are the high time resolution and the high surface velocity capability. The limitations in rise time are limited by the capability of the photomultiplier or oscilloscope recording system. The bandwidth of each system is typically 600 MHz or a response time of ≈ 1 nsec."

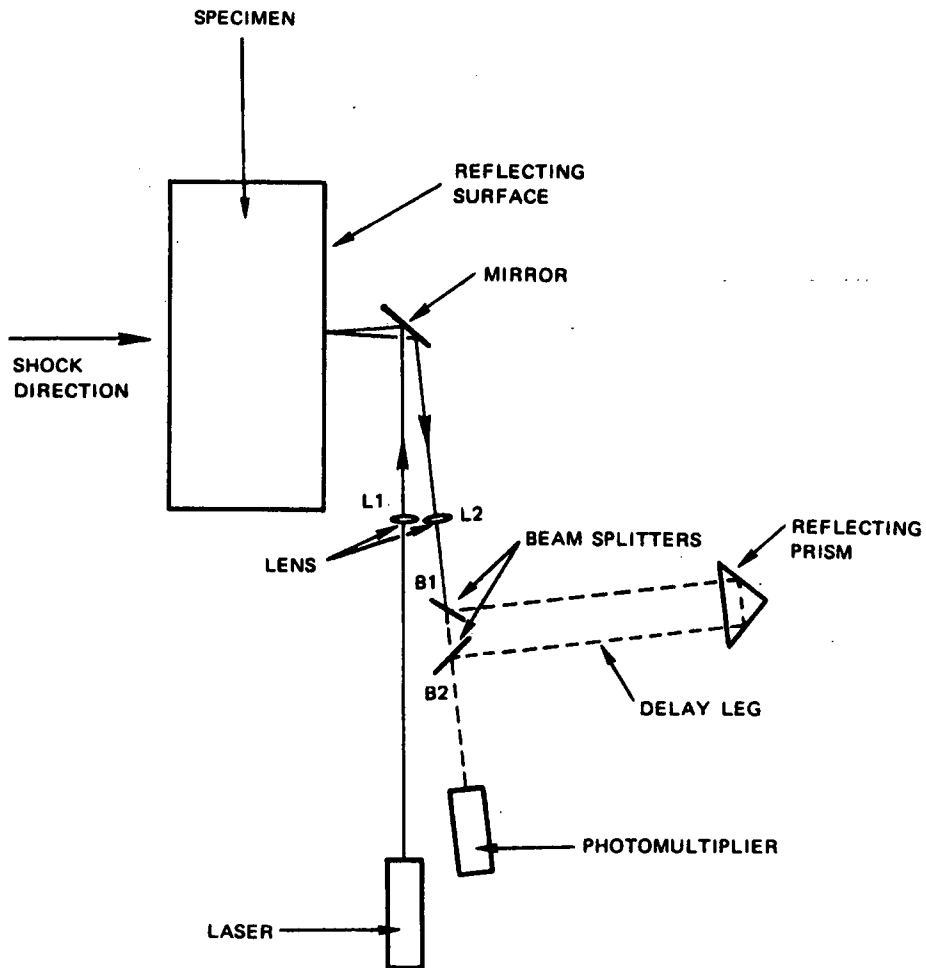

Fig 5-13 Laser Interferometer System (The velocity of the reflecting surface is related to the number of fringes observed by the photomultiplier)

A more detailed description of laser interferometry as it applies to particle velocity studies is to be found in Refs 11 & 12. Results of these studies will be discussed in Section IV

EMV Method

A generalized description of this technique is given in Ref 7. We quote: "The Faraday foil technique utilizes the voltage generated between ends of a conductor moving in a stationary magnetic field as a measure of foil velocity. Experimentally, a metal foil, small in the direction of shock propagation is placed in or between sections of a sample. The sample is placed in a uniform magnetic field and, as the sample is accelerated by the passage of a stress wave, the foil moves with the sample. The voltage induced

across the foil is monitored as a function of time on an oscilloscope.

The relation between the voltage induced and particle velocity is

$$V = \vec{\ell} \cdot \left(\vec{u} \times \vec{H} / 10^4 \right) \quad (5-13)$$

where $\vec{\ell}$ is the length of conductor in millimeters, \vec{u} is particle velocity in millimeters per microsecond, \vec{H} is the field strength in gauss, and V is the voltage in volts. The accuracy of measurement is limited by the ability to measure \vec{H} and the effective length $\vec{\ell}$ of the conductor, and by a knowledge of the magnetic susceptibility change of the sample during shock loading.

Advantages of the Faraday foil technique are (1) high time resolution, (2) simplicity, and

(3) most important, the capability of measurement within a test specimen. Disadvantages are the difficulty in calibration of the system and the restriction to measurement in a nonconductor."

A more specific description of this method (which was originally developed by Dremin and coworkers – see Ref 1) is given in Ref 4. We quote: "The principle of the electromagnetic velocity EMV gage is a simple adaptation of Faraday's law of electromagnetic induction. A rectangular "loop" of wire or foil is embedded in the non-conducting medium to be studied. The base of the loop of length, ℓ , is the sensing element. It connects to the arms in the shape of a squared letter U, see Fig. 1. The loop is connected to a coaxial line either directly or with a resistance R_1 in series. The coaxial line, terminated by its characteristic impedance, is connected to a recording oscillograph (scope). For a magnetic field, H , and a loop enclosing area, A , the induced voltage in the loop is proportional to the time rate of change of flux $d(H \cdot A)/dt$ within the loop. When the field is normal to the area and the change in flux is due only to the motion of the base normal to the field the induced EMF is given by

$$V = H \times u \times \ell \times 10^{-4} \text{ (volts)} \quad (1)$$

where the velocity of the base is in $\text{mm}/\mu\text{sec}$, ℓ in mm, and H in gauss. If the base were a foil of the order of 20 microns thick, its velocity would be the same as the medium soon (a few nanoseconds) after passage of a shock. Thus, except for response delays, the observed voltage will be a direct measure of the particle velocity of the medium; the EMV gage is therefore an absolute measuring transducer. The time rate of change of flux has been brought up to make it clear that motion of the arms which could change the loop area or change in flux due to stray fields would introduce errors in the recorded voltage. For maximum precision the shock wave should therefore be plane and stray fields should be minimized.

With present day scopes, adequate output voltage is possible with field strengths as low as 300 gauss; we have generally used about 1000 gauss to increase the signal to noise ratio. Practical gages would have a base length of 5 to 10 mm, foil thicknesses between 10 and 80 microns and foil widths of 1 to 5 mm. Aluminum is a

good foil material because of its moderately low shock impedance and high conductivity. It is simply folded about a squared off section of the sample to form the squared U shape. Silver or copper would be comparably good conductors. They may be better than aluminum in studies within detonating explosives where there is a possible danger that aluminum could react with the explosion products thereby reducing the conduction of the base. For optimum recording the rise time of the oscillograph should be small relative to the time required to shock the foil up to the particle velocity in the medium under study. (Rise time is customarily defined in electronics as the time for the response to a square step input to rise from 10 to 90% of the steady value.) We have used scopes of 2.4, 7.0, and 26 ns rise time. The last was found to give relatively poor records.

EXPERIMENTAL SET-UP FOR PMMA STUDIES

Fig 1 shows schematically the set-up for studying the particle velocity in a plastic or an

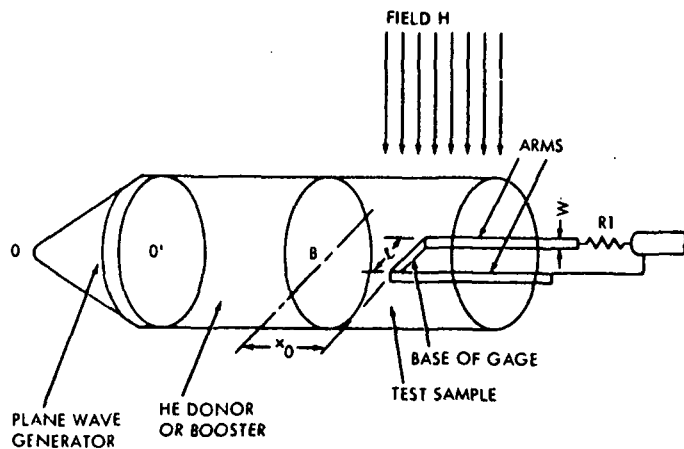

Fig 1 Schematic Drawing for EMV Gage Measurements (from Ref 4)

explosive. In the studies with PMMA the set-up used was that of the donor-gap configuration of the NOL LSGT (see Vol 9, S62). Referring to Fig. 1, this consisted of a pressed tetryl donor of density $1.51 \pm 0.01 \text{ g/cc}$. The donor had a diameter of 5.08 cm and an equal length. It has a reported detonation velocity of $7.2 \text{ mm}/\mu\text{sec}$. Tentatively the Chapman-Jouguet, CJ, detona-

tion pressure can be taken to be ~ 195 kbars. The explosive is point initiated by a 30 cm primacord lead at point O' . The detonator for the primacord was of the Exploding Bridgewire EBW type to increase safety in the presence of magnetic fields. The plane wave booster, PWB, shown in Fig. 1 for later discussion is absent. The PMMA samples were machined from Plexiglas rods having a density of 1.18 ± 0.01 g/cc. The diameter was 5.08 cm. The EMV gage was made of a foil of aluminum usually 2 mm wide; thickness δ , 13 microns (0.5 mils); and base length either 5 or 10 mm. The gage and gap assembly was formed by wrapping the foil about a block of PMMA of appropriate width; cementing on side blocks with the aid of chloroform as a solvent to form a cylinder; and finally cementing to a cylindrical block of length x_0 to form the gap between the donor and the base of the gage. Care was taken to eliminate air bubbles. The total length of PMMA was $x_0 + 12.7$ mm. For future reference the shock vs particle velocity relation for the PMMA was assumed to be

$$U = 2.56 + 1.61 u \text{ (mm}/\mu\text{sec)} \quad (2a)$$

in the particle velocity range of interest. With the above stated dimensions the Hugoniot pressure, in kilobars, is given by the equation

$$P = 10 \times U \times u \times \rho_0 \quad (2b)$$

in which ρ_0 = initial density in g/cc.

The gage arms were 32 to 44 mm long, including R_1 when it was used. In the first experiments no series resistor was present. Later it was found, when using a fast response scope, that a value of R_1 of about the characteristic impedance of the coaxial line reduced ringing in the recorded signal. The exact value of R_1 was determined by measurement with a reflectometer to find the value for minimum signal reflection. The coaxial line was an RG 58 C/U, 50 ohm nominal impedance, 5 meters long. It was terminated at the scope with a 50 ohm terminator.

The magnetic field was obtained by the use of Helmholtz coils or an iron core magnetic. The former had mean coil diameters of 38 cm spaced 19 cm apart to maximize the uniformity of the field near the gage base. This gave a usable working gap of about 4 cm. The latter had square pole faces of 10.2 cm on a side spaced

8.9 cm apart. For this magnet the field was uniform to within 0.6% in the space required for a measurement. The iron core magnet faces were covered with 6 mm of wood to protect them and to prevent the generation of stray signals observed when the air shock was allowed to hit the conducting face.

A sheet aluminum baffle reaching from the periphery of the charge to the poles of the magnet was located in the plane of the HE-PMMA interface. When grounded to a coaxial trigger line it was effective in reducing one source of noise to an acceptably low level. The grounding was essential."

Additional details (as they pertain to Tetryl) and various schemes of estimating the C-J point from EMV particle velocity data are given by Edwards et al (Ref 6). Although these schemes agree amongst themselves, the u_{CJ} thus obtained seems to be low

A variant of the electromagnetic technique used the electromagnetic particle velocity gage (EPV). These gages are particularly useful for investigating reactive flow processes. According to Cowperthwaite and Rosenberg (Ref 16): "An EPV gage consists of a straight, high-aspect ratio (length to cross-sectional area) metallic conductor (the active element) embedded in the target in the expected plane of the wavefront; a constant externally generated magnetic field aligned perpendicularly to the active element and to the wave propagation direction; and electrical leads from the active element to the recording instrumentation oriented in such a way that they will not contribute to the signal.

When the active element moves in response to the surrounding flow, a motional electromotive force (EMF) proportional to the velocity is generated. From Faraday's law of induction for moving circuits, this can be shown to be given by

$$E(t) = [\vec{v}(t) \times \vec{B}] \cdot \vec{\ell} \quad (2.1)$$

where E is the EMF, t is time, \vec{v} is the velocity of the active element, \vec{B} is the magnetic induction, and $\vec{\ell}$ is the active element length. Thin gages that equilibrate rapidly with the surrounding flow are used so that after a short ring-up time, $v(t)$ is equal to the particle velocity in the reactive flow (i.e., the gages are Lagrangian)."

The gages used were Al foil strips because Al provides a good impedance match to detonation

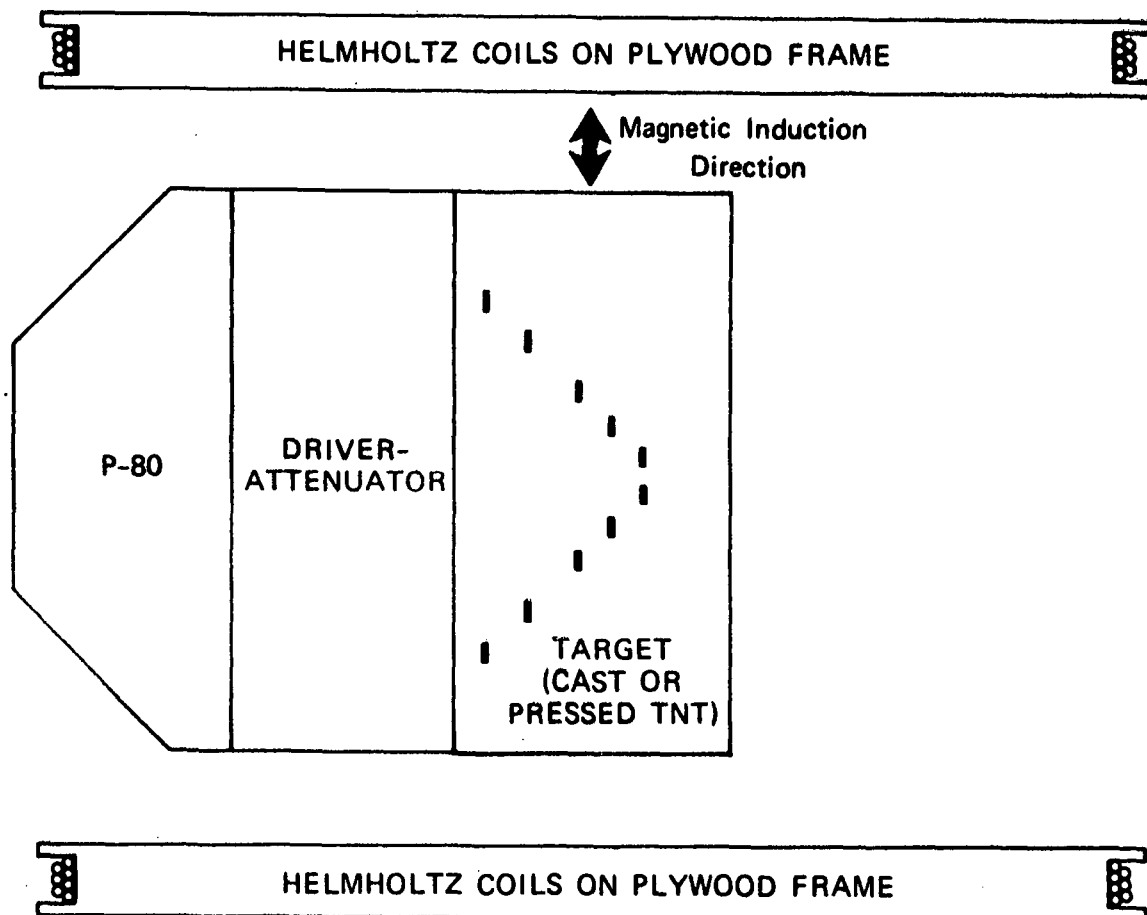
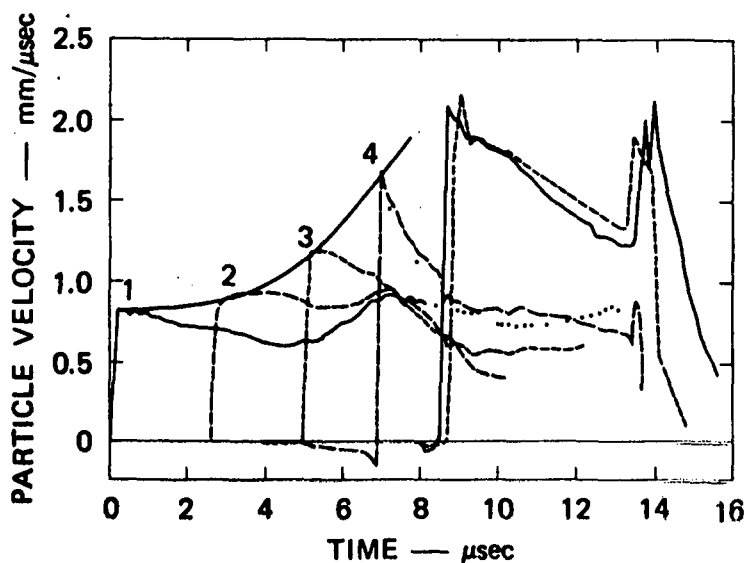

Fig 2 Configuration of Embedded Particle Velocity Gage TNT Experiments (Not To Scale)
 The vertical lines in the target represent cross-sections of the active elements of individual electro-magnetic particle velocity gages; ten gages are indicated

Fig 3
 Particle Velocity Histories, Shot 3301-2-5 (Cast TNT, Gage Grooves)
 Distances in mm from driver-attenuator/target interface to gage centers are 0, 10.6, 21.2, 32.1, 42.5, and 44.1. Note that the last two records are PMMA; the records from the four primary gages embedded in HE are numbered



products. The test material was either cast or pressed TNT with a plane-wave (P-80)-attenuator system providing the input shock. The magnetic field was generated by expendable Helmholtz coils. A schematic of the system used is shown in Fig 2

Fig 3 shows the type of records obtained in Ref 14. Some discussion of the significance of particle velocity histories (such as Fig 3) will be presented in the following section

Flash X-Ray Method

X-ray absorption furnishes an absolute measure of the density of matter. However, in many applications the important observations to be made with X-rays concern the geometrical relationships of shock fronts and contact surfaces; it is in this area where X-rays, because they make it possible to "see inside" the detonating expl, provide a uniquely appropriate tool. Until recently the difficulty has been the inability of available sources to penetrate charges more than a few inches in diameter. With the advent of the **PHERMEX** machine this difficulty has been overcome. Phermex provides a pulsed beam of 27 Me V electrons in 0.1 microsec bursts, which impinge on a tungsten target to generate X-rays that can easily penetrate several cm of HE. Recall that density of the shocked material can be related to particle velocity thru the conservation equations (see Vol 7, H179)

Rivard et al (Ref 3) describe this technique as follows: "The **PHERMEX** flash x-ray machine at Los Alamos has given us for the first time a long-needed direct quantitative look at the one-dimensional flow behind a plane detonation wave in a large-diameter charge, and a new determination of the state at the front. A sequence of radiographs records at discrete times the position of the detonation front and of mass elements marked by tantalum foils embedded in the explosive. Electrical signals from the passage of the wave over the foils give a separate measurement of the detonation velocity. The experimental setup and a typical radiograph are shown in Fig. 1. The x-ray beam axis is perpendicular to the direction of detonation in a 10 cm cube of Composition B-3 explosive (the HE) which is initiated by a large diameter plane-wave lens. (Since the machine can be flashed only once during the passage of the detonation wave, the time sequence is obtained from repeated experi-

ments with the HE as nearly identical as possible.) The range of front positions recorded is 5 to 10 cm.

The radiographs show an adequately large

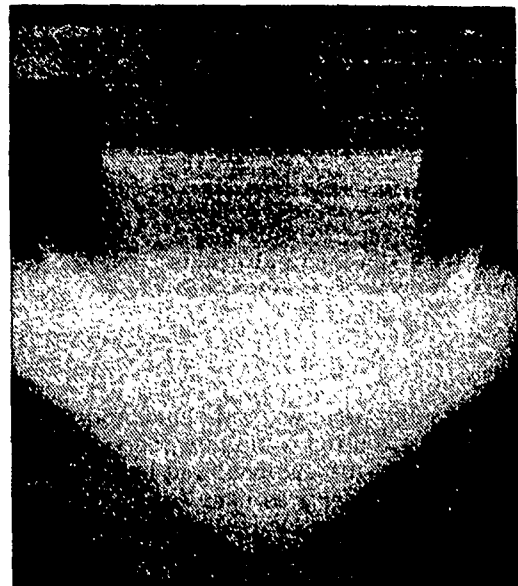
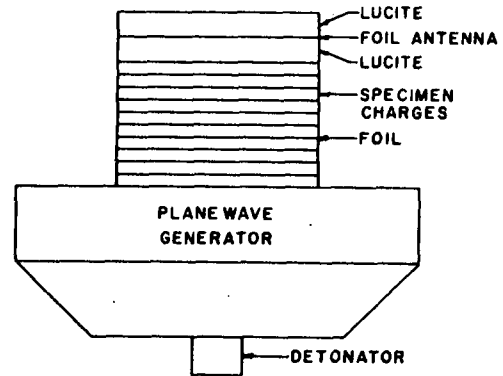

Fig 1 Experimental Arrangement and Radiograph (from Ref 3)

central region of one-dimensional flow not yet affected by the incoming side rarefactions. We confine our attention to this region and treat the flow as one-dimensional and laminar. Thus all results are averages over any fine-scale structure due to transverse waves on the front or to the granular nature of the material.

A density profile is obtained directly from each radiograph. Least-squares fitting of a continuous function to the measured final foil positions x_f as a function of their initial positions

x_i gives the density distribution by differentiation:

$$\rho_0/\rho = dx_f/dx_i \quad (1)$$

Evaluation of the density at the front, together with the Rankine-Hugoniot relations and the measured front velocity, determines the pressure and particle velocity there. In practice, this requires an additional assumption, which will be made throughout. Since the reaction zone is much smaller than the foil spacing, the reaction is treated as instantaneously complete within the shock transition, and the final state to which the Rankine-Hugoniot equations apply is taken to be the equilibrium state at the end of the reaction zone. No evidence of a reaction zone can be detected either in the analysis of the foil data or on the radiographs.

Additional information is obtained from the sequence of radiographs by fitting a function $x_f(x_i, t)$ to the entire collection of data. Partial differentiation of this function with respect to t at constant x_i (that is, along a particle path) gives the particle velocity field. Finally, with one additional assumption, the pressure and internal energy in the interior can be determined by applying the equations for conservation of momentum and energy. The additional assumption, probably quite good for this flow, is that viscous forces and other transport processes can be neglected.

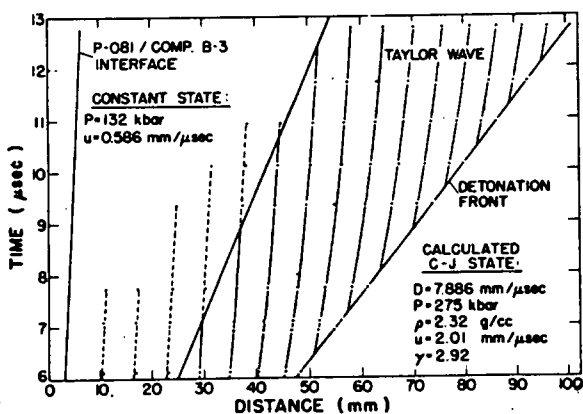

Fig 2 Measured Foil and Front Positions in the $x-t$ Plane. (from Ref 3)
The detonation wave crosses the lens/HE interface at $x = t = 0$. The curves connecting the points are from a fit to the data

The classical detonation model consisting of a front moving at the constant Chapman-Jouguet (CJ) velocity followed by a centered rarefaction (Taylor) wave is found to represent the data within experimental error. Figure 2 shows a portion of the flow in the $x-t$ plane according to this model, together with the measured foil and front positions. The CJ pressure obtained here is significantly lower than that given by the conventional method of measuring the free-surface velocity of driven plates."

We have already noted that agreement among various techniques for measuring particle velocity is at best only fair. The following abstract of a paper by Davis and Venable (Ref 5) exemplifies this. In this abstract, measurement techniques are compared according to detonation pressure, which is directly proportional to u , since ρ_0 and D are constant (see Eqn 1): "A new technique for measuring detonation pressure by using x-ray photography to trace the position of a rarefaction wave as a function of time is described. The pressure value obtained for Composition B-3 is compared with values obtained with other techniques. The values are $\leq 268 \pm 6$ kbar with the new x-ray technique, 275 ± 4 kbar using another new x-ray technique, 292 ± 5 kbar using an old plate-push technique, and 312 ± 5 kbar using a newer plate-push technique. No satisfactory explanation for the large range of values is presented. There seems to be no reason to choose one value as "correct" in preference to the others."

In a more recent study, Davis (Ref 13) again points out the nagging uncertainty in the interpretation of particle velocity measurements in detonations. Measured PBX 9404 particle velocities, according to Davis, agree with C-J theory, but measurements in Comp B or TATB/Kel F 95/5 do not

Examples of u vs time curves for TNT and Tetryl, obtained by Jacobs & Edwards (Ref 4) are shown in Figs 4-6. As expressed by these authors: "The determination of a CJ particle velocity and a reaction zone time by the EMV gage has required judgment to select the point on the curves which one would associate with the "termination" of the reaction. This is not always a simple matter. In our pressed TNT records there was little choice but to take the time at which the $u-t$ curve levels off as the CJ

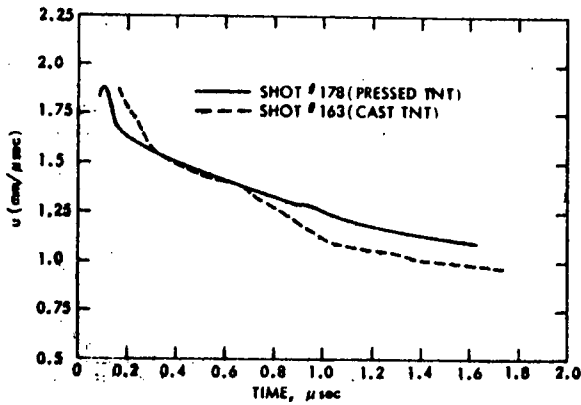

Fig 4 Comparison of Results for Cast and Pressed TNT at 25.4mm from PWB. (Cast TNT initiated by 12.7mm of pressed TNT following PWB)

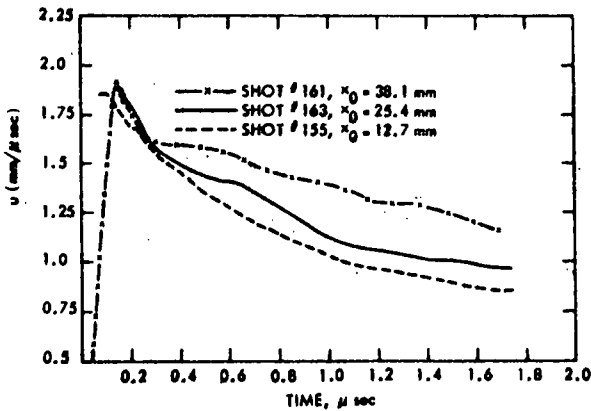

Fig 5 Effect of Gage Distance from PWB on Particle Velocities for Cast TNT

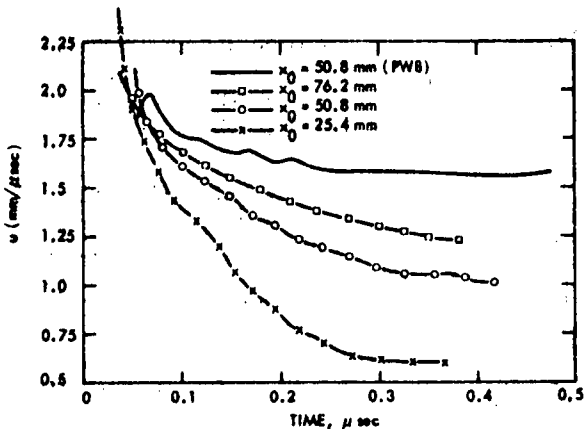

Fig 6 Gage Records for Pressed Tetryl, both Point and Plane Initiation

value. This leads to a moderately reproducible particle velocity but a fairly wide spread in the selected reaction time. It is unlikely that the time spread is real; the explosive is likely to be fairly reproducible from shot to shot except for an occasional bad experiment"

The following comparisons of the FSV and EMV methods (Table 1) are taken from Dremine & Shvedov (Ref 1). They are for pressed TNT, and Dremine was involved in both sets of measurements. Also included is a measurement from Ref 4

Table 1
Comparison of FSV and EMV Data for TNT

ρ_0 (g/cm ³)	u_{CJ} (km/sec)	
	FSV	EMV
1.60	—	1.67 (Ref 4)
1.59	1.76	1.60
1.45	1.66	1.51
1.00	1.30	1.23

Results of LASL FSV measurements differ even more from Dremine's or Jacob's EMV data. Dremine attempts to show that previous FSV results were misinterpreted. However, based on the discussion by Jacobs and Edwards (Ref 4), interpretation of EMV data also requires "judgment" and is not entirely objective

Similarly, detonation pressure (and consequently u_{CJ}) of PBX 9404 obtained by an adaptation of the EMV technique (Ref 15) is appreciably lower than that obtained by FSV techniques

IV. Theoretical Considerations

This section covers two main subjects, namely theoretical estimates of u_{CJ} , and application of measured particle velocity histories to elucidation of initiation phenomena in detonations and to flow characteristics behind the detonation front

Theoretical estimates of u_{CJ}

Particle velocity (u_{CJ}) at the Chapman-Jouguet (CJ) plane can be computed by use of the conservation equations, the C-J condition and an appropriate equation of state (EOS) for the detonation products. It is the lack of an unequivocal EOS that makes such calculations uncertain. If the detonation products are perfect gases

(products of gaseous detonation at initial pressures of 1 atm or less approach this requirement), then the Eqns given in Vol 9, T211 can be used to compute u_1 , which we now have called u_{CJ}

Obviously detonation products of condensed expls do not obey the perfect gas law. To date there is no universally accepted EOS for deton products. If they are assumed to behave as a *polytropic* gas, some of the Eqns of Vol 9, T211 apply, provided γ_1 is replaced by κ_1 , the polytropic (also known as the adiabatic) coefficient. The Eqns that are *inapplicable* are the ones containing T_1 . Extensive calcns based on the BKW EOS (see Vol 4, D273) have been made by Mader (LASL 2900, 1963). More recently, a physically more realistic EOS has gained appreciable acceptance. The EOS, called JCZ-3, has been described in Vol 9, T212. CJ particle velocities computed with the BKW or JCZ-3 EOS are in fair agreement

A semi-empirical approach of appreciable merit is that of Jones (quoted in Ref 7, pp 7-9 to 7-13). Its advantages will be discussed in the article on *Specific Volumes* of detonation products. Its application to u_{CJ} is given below:

$$u_1 = D/[g_0(2 + \lambda)],$$

where $g_0 = 1 + d\ell n D/d\ell n \rho_0 = 1 + \rho_0 B/D$, if $D = A + B\rho_0$ where A and B are constants. Thus u_{CJ} (or u_1 in the above notation) can be estimated from exptly determined variation of D with ρ_0 . Jones showed that $0 \leq \lambda \leq 0.25$. Conse-

quently uncertainty in λ will make a relatively small uncertainty in the estimate of u_{CJ}

To avoid arguments about the appropriate EOS we shall briefly examine two studies of gaseous detonation in which exptl detonation parameters are compared with theoretically computed parameters based on the *ideal gas* EOS. Veysiere and Brochet (Ref 2) used the EMV technique to obtain particle velocity data for H_2/O_2 mixts initially at 1 atm and $295^\circ K$. Their results are summarized in Fig 7, where X is the distance *behind* the detonation front. Note that the measured particle velocity is greater than the computed u_{CJ} , $(u_b)_{th}$ in their notation, for $x \leq 50$ mm

Gas detonation at reduced initial pressures were studied by Vasil'ev et al (Ref 8). They point out the errors in glibly comparing ideal lossless one-dimensional computations with measurements made in 3-dimensional systems. We quote: "In an ideal lossless detonation wave, the Chapman-Jouguet plane is identified with the plane of complete chemical and thermodynamic equilibrium. As a rule, in a real detonation wave the Chapman-Jouguet state is assumed to be the gas state behind the front, where the measurable parameters are constant, within the experimental errors. It is assumed that, in the one-dimensional model of the detonation wave in the absence of loss, the conditions in the transient rarefaction wave accompanying the Chapman-Jouguet plane vary very slowly if the

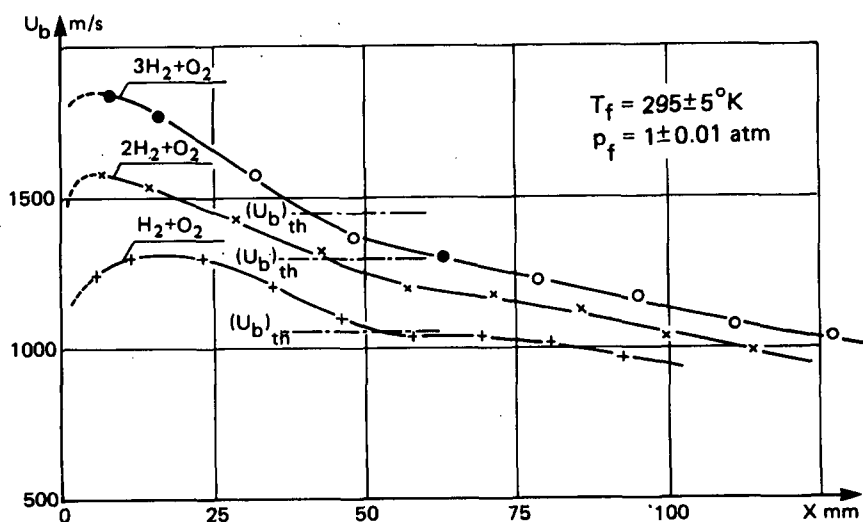

Fig 7 Particle Velocity Profiles for H_2/O_2 Detonations

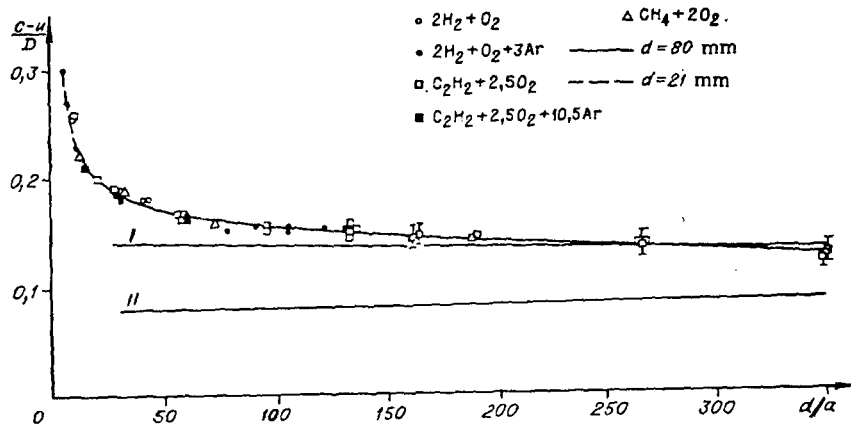

Fig 8

wave has moved a sufficiently long distance. However, the real Chapman-Jouguet surface, whose existence and boundaries have been experimentally established, lies closer to the detonation front than the region in which the measurements are usually carried out. Since we know the boundaries bracketing the Chapman-Jouguet surface, we believe it is interesting to find the gas-dynamic parameters in this region and to compare them with the calculated parameters."

They also establish the interesting fact that the dimensionless quantity $(c-u)/D$ is much more sensitive to small changes in the gas state than D , u , P , or ρ . Here c is the local sound velocity. Their results are summarized in Fig 8, whose abscissa (d/a) is diameter/cell size. The cell size refers to inhomogeneities (cells) in the structure of the detonation front. These become smaller as initial pressure increases, i.e., d/a is generally large at ambient pressures of 1 atm or greater

Note that widely different mixts all follow a single curve. The horizontal lines I and II are theoretical computations. Line I is based on a "frozen" sound velocity and line II is based on an equilibrium sound velocity. Clearly the former provides a better fit (at large d/a) to the exptl data than the latter. Frozen sound velocity is computed under the assumption that compn and entropy remain constant, while for equilibrium sound velocity one assumes the chemical reaction manages to follow the changes in the expansion isentrope. Vasil'ev et al suggest that the larger-than-theoretical values of $(c-u)/D$ at small d/a are due to an increase in c because

of turbulence. This "turbulent" sound velocity c^* is given by

$$c^* = \sqrt{c_i^2 + \Delta u^2},$$

where Δu is a "pulsation" velocity. Fig 9 shows how Δu varies with d/a and becomes negligibly small where measured $(c-u)/D$ approaches its theoretical value. However, for small diameter tubes Vasil'ev et al claim that turbulence is not the sole explanation of Fig 9

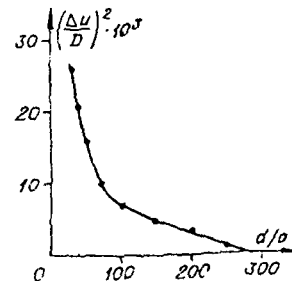

Fig 9

Still unexplained, at least to this writer, is the large distance behind the detonation front at which EMV-measured u approaches u_{CJ} (Fig 7)

Fisson & Brochet (Refs 9 & 10) used the EMV technique to determine u_{CJ} in *Nitromethane* (NM) and *Isopropyl Nitrate*. For NM their results are shown in Fig 10. Their best estimate for u_{CJ} is 1.70km/sec, which, somewhat unexpectedly, is a little larger than u_{CJ} determined by the FSV method. Recall that for solid expls (Refs 1, 3, 5 & 13 and Table 1) the FSV method gives higher values of u_{CJ} than the EMV method. LASL's theoretically computed u_{CJ} for NM (BKW EOS) is 1.78km/sec

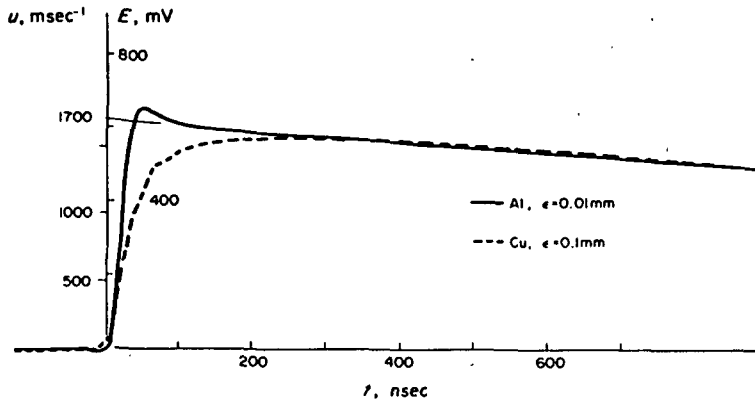

Fig 10

For *Isopropylnitrate* $u_{CJ} = 1.49\text{km/sec}$ (Ref 9) Kennedy et al (Ref 11) and Nunziato et al (Ref 12) used laser interferometry to obtain the particle velocity histories in PBX 9404 shown in Fig 11 for "long-duration" input pulses and in Fig 12 for "short-duration" pulses. The PBX 9404 targets were too thin (δ is target thickness) to detonate, but particle velocity increase denoting reaction in the targets is clearly indicated. These particle velocity histories are qualitatively similar to those obtained in Ref 16, shown in Fig 4

Kennedy and Nunziato propose a "critical acceleration" criterion for shock growth in expls subjected to shocks of smaller amplitude than P_{CJ} . They also compute an energy release rate

and relate it, as well as the critical acceleration, to particle velocity. Their results are summarized in Fig 13. It is seen that for particle velocities of less than 0.6mm/microsec the reaction is endothermic (mechanical dissipation exceeds heat generation) and exothermic above 0.6mm/microsec . Thus for the conditions of their expt, 0.6mm/microsec can be considered as an *upper limit* critical particle velocity for shock initiation of PBX 9404, since the 6mm sample exhibited considerable reaction and thicker samples should have detonated. The writer, from data presented at the 5th DetSymp, estimates that "long-duration" plane-wave input shocks of $u \sim 3\text{mm/microsec}$ will initiate PBX 9404 provided a sufficiently thick sample is shocked

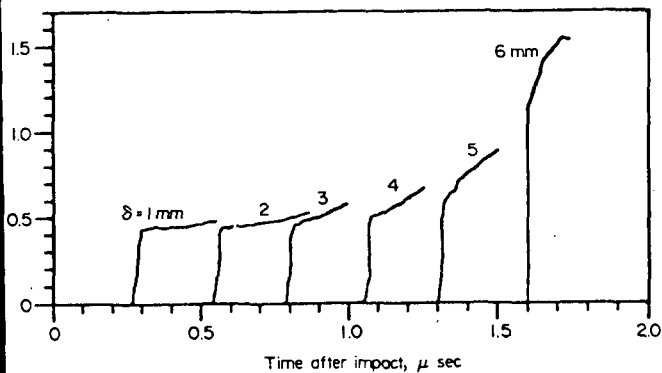

Fig 11 Particle velocity histories observed in fused-silica window in long-duration pulse ($1.1\ \mu\text{sec}$) experiments. Corrections have been made for waveform distortion and transit time through the 1.5mm thick buffer of fused silica

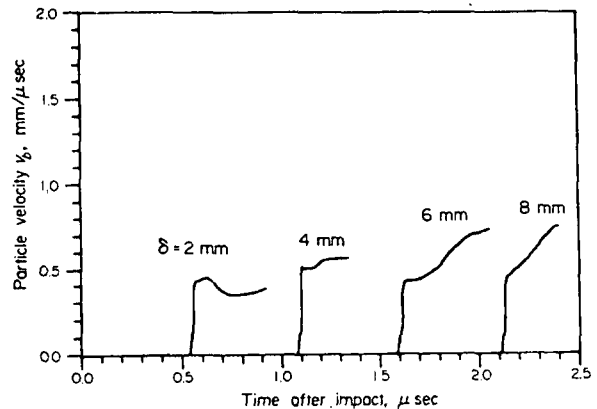

Fig 12 Particle velocity histories observed in fused-silica window in short-duration pulse ($0.28\ \mu\text{sec}$) experiments, with corrections made for buffer transit time and waveform distortion

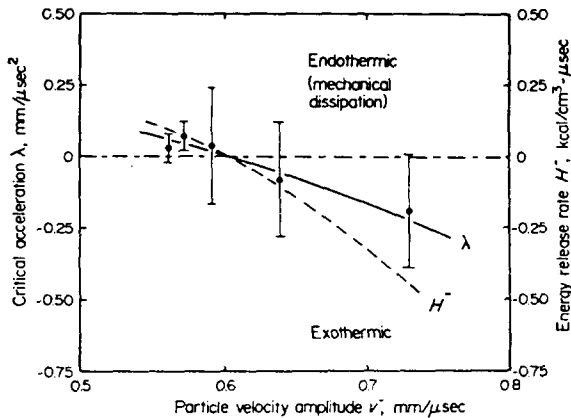

Fig 13 Critical acceleration and energy release rate curves determined from long-duration pulse experiments, as functions of shock amplitude v' in PBX 9404. Energy rate shown is the net result of mechanical dissipation and exothermic chemical reaction. Following thermochemical convention, energy release rate due to exothermic reaction is denoted as a negative value of H^-

Cowperthwaite & Rosenberg (Refs 14 & 16) applied Lagrange analysis to the wave fronts and the flow behind the wavefronts of the records shown in Fig 3. These records are for cast TNT. Records for pressed TNT are similar but buildup to detonation occurs in a shorter time. They conclude that at an input pressure of 50kbars in cast TNT:

- Buildup to detonation is governed by the energy release rate in the whole wave rather than the energy release rate at the wavefront
- Particle velocity gradients near the wavefront are negative because the negative pressure gradient created by the overall reaction in the wave exceeds the expansion associated with local reaction
- Initiation of detonation will always occur if the rear-boundary condition is maintained long enough to allow the peak in the Lagrange particle velocity histories to overtake the wavefront
- For smoothly accelerating wavefronts, the initiation criterion is that the peak in the pressure-Lagrange distance profiles overtakes the wavefront

Written by J. ROTH

V. Refs: 1) A.N. Dremin & K.K. Shvedov, *ZhPriklMekhiTekhnFiz* 3, 139 (1964) 2) M. Veysiere & C. Brochet, *CRAcadSci(Paris)* 267, 924 (1968) 3) W.C. Rivard et al, 5th DetSymp (1970), 3 4) S. Jacobs & D.J. Edwards, *Ibid*, 413 5) W.C. Davis & D. Venable, *Ibid*, 13 6) D.J. Edwards et al, *NOLTR 78-83* (1972) (AD 749007) 7) Anon, *EngrgDesHndbk*, "Principles of Explosive Behavior", *AMCP 706-180* (1972), pp 5-15 to 5-18 8) A.A. Vasil'ev et al, *FizGorVzryva* 9, 309 (1973) 9) F. Fisson & C. Brochet, *Acta-Astronautica* 3, 541 (1975) 10) F. Fisson & C. Brochet, *Ibid*, 1077 (1976) 11) J.E. Kennedy et al, *Ibid*, 811 (1976) 12) J.W. Nunziato et al, 6th DetSymp (1976), 47 13) W.C. Davis, *Ibid*, 637 14) M. Cowperthwaite & J.T. Rosenberg, *Ibid*, 786 15) C.A. Campos, *Process Development Endeavor* No 231, *Mason-Hanger* (1978) 16) M. Cowperthwaite & J.T. Rosenberg, *Final Rept*, Stanford Res Inst Project *PYU-3301* (1979)

Velocity, Projectile. See earlier treatments in Vol 2, B5-R to B6-L, under "Ballistic Measuring Methods and Ballistic Tests"; in Vol 3, C304-R to C310-R, under "Chronoscopes, Chronometers and Other Devices Used in Measuring Velocities of Projectiles in Flight and of Detonation Velocities of Explosives"; and in Vol 8, M162-R to M163-L, under "Muzzle Velocity"

Probably the most important measurement in the design of an overall weapon system is that of velocity of the projectile. It is desirable to know the velocity of the projectile at all times from ignition of the propellant to target impact. However, the most often used measurement is that of velocity at the muzzle of the gun

Muzzle velocity usually is determined from the time taken for the projectile to travel between two detectors a known distance apart. This time is measured with an electronic time interval meter or chronograph. Since this method gives the average velocity over the distance of measurement, it is necessary to record two or more velocities ahead of the muzzle and extrapolate back to muzzle velocity. A diagram of a typical set-up is shown in Fig 1

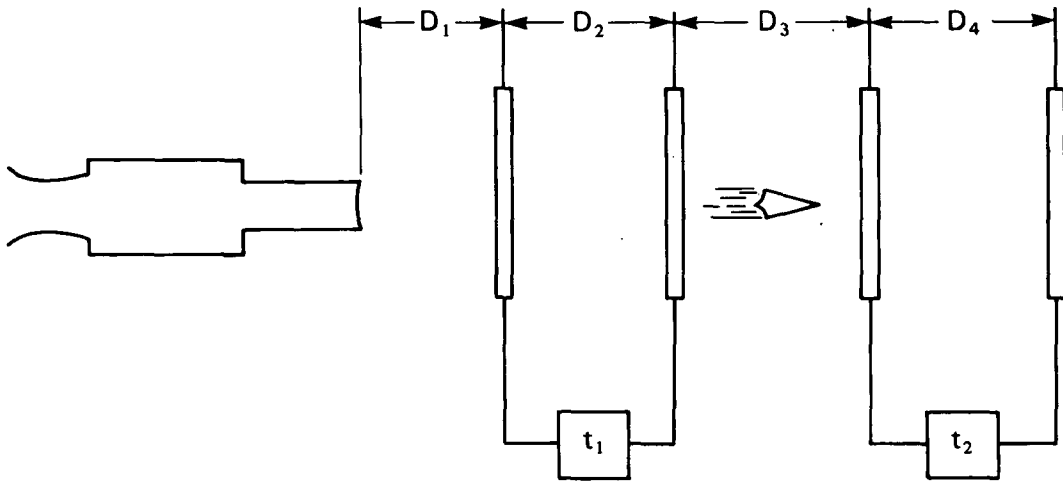

Fig 1 Velocity Measurement Schematic

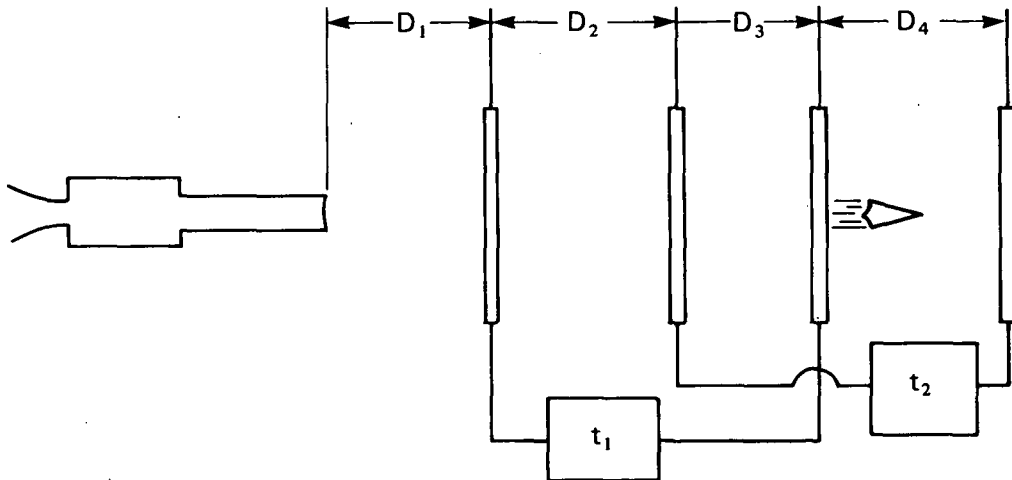

Fig 2 Velocity Measurement with Staggered Array of Detectors

From the arrangement in Fig 1, the following may be determined:

Average velocity: $V_1 = \frac{D_2}{t_1}$, fps

Average velocity: $V_2 = \frac{D_4}{t_2}$, fps

Retardation: $R_r = \frac{V_1 - V_2}{\frac{D_2}{2} + D_3 + \frac{D_4}{2}}$, fps/ft

Considering the retardation to be linear, which is approximately true for short distances (eg, 100 ft), the muzzle velocity V_m is given by the equation:

$$V_m = V_1 + \frac{R_r}{(D_1 + D_2/2)}$$

When range space is limited, it may be desirable to stagger detectors as shown in Fig 2 to achieve greater velocity accuracy by permitting longer baselines with a reduction, however, in distance between velocities and hence an increased retardation error

From the arrangement of Fig 2, the following may be determined:

$$V_1 = \frac{(D_2 + D_3)}{t_1}$$

$$V_2 = \frac{(D_3 + D_4)}{t_2}$$

$$R_r = \frac{2(V_1 - V_2)}{(D_2 + D_4)}$$

$$V_m = V_1 + R_r \left[D_1 + \frac{(D_2 + D_3)}{2} \right]$$

Errors inherent in both these methods are:

1) error in distance measurement, usually in the range of ± 0.01 ft; 2) detector error: error caused by time delays in the detector, uncertainty in projectile location at which the electrical pulse output is generated; and 3) error in time measurement: $\pm 1 \mu\text{sec}$ with a 1 MHz time interval meter, providing that electrical time delays do not occur in transmission lines between detectors and meter

The use of a long baseline (distance between detectors) can decrease both timing and distance measurement errors; however, its length often will be limited by firing range facilities, especially if a rather high firing angle is used. It is necessary to make two velocity measurements for accurate determination of muzzle velocity; if a linear extrapolation is used, the two velocity measuring systems should be close together

The determination of muzzle velocity, as described, actually gives the velocity at some point slightly forward of the muzzle, since escaping gases accelerate the projectile after it leaves the

muzzle. In recoilless rifle weapon systems this increase is not significant due to the reasonably low pressures and velocities encountered. It is desirable to locate the first velocity detector some distance from the muzzle to prevent muzzle blast or flash from affecting the detector performance. This distance may vary from 15 ft for a 57mm gun to as much as 50 ft for high velocity larger caliber guns. The recommended baseline for a velocity system is in the order of 25 to 50 ft to assure an error of $\pm 0.1\%$ (± 1 fps at 1000 fps) or less in velocity caused by distance measurement and detection error

Detecting Devices

The purpose of the detecting device is to produce an electrical signal indicating the passage of the projectile at a known point in space. There are several types of detectors suitable for projectile velocity determinations, each of which have certain advantages and disadvantages

Breakwire System

This system consists of a grid of wire, or paper with a conductive grid strung across a frame made of an insulating material such as wood. The wire is broken by the passage of a projectile thru it. Normally, a current is passed thru the wire, and a chronograph is used to sense the reduction in current when the wire is broken. While this is probably the most simple detecting device, it requires replacement of the wire after each firing. In addition, the wire has a tendency to stretch before breaking, especially when pointed projectiles are used, causing an error in baseline measurement. This error may be minimized by using hard drawn wire, keeping it

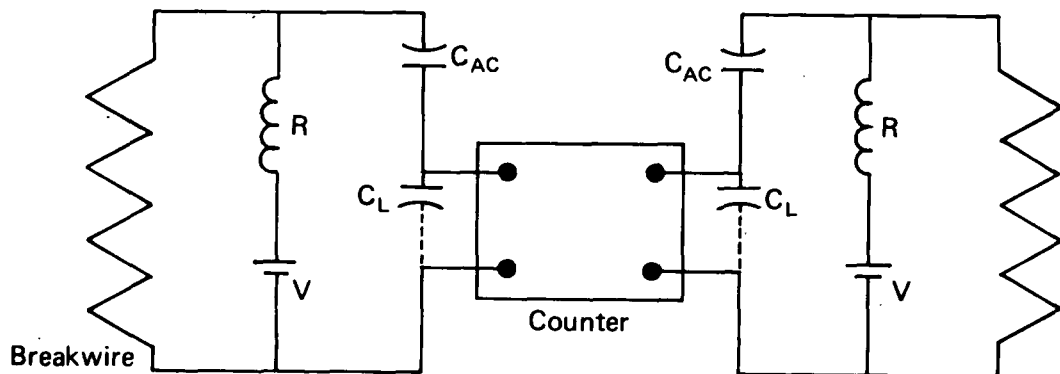

Fig 3 Circuit for Breakwire System

stretched taut, and using narrowly spaced grid wires. The circuit used with this system is shown in Fig 3

The breakage of the wire will cause the voltage across the terminals of the chronograph or time interval meter to rise to V , considering that the input resistance of the counter is high with respect to R . Since the line between the breakwire and the chronograph normally will have a capacitance C_L , the rise to V will not be instantaneous. The approximate value for any value of C_L the line capacitance, and V_T the triggering voltage of the chronograph may be determined from the equation:

$$I = \frac{V}{R} = \frac{C_L V_T}{t}, \text{ A} \quad (\text{Eq 1})$$

$$(\text{for } V_T \ll V, C_L \ll C_{AC})$$

where: I = current in closed circuit, A

V = power supply voltage, volt, $\geq 50V_T$

R = series resistance, ohm

C_L = capacitance of line, chronograph input and break circuit, μF

t = signal delay time, μsec , for error permitted

V_T = triggering voltage of chronograph example, V

An example of the application of Eq 1 follows:

Given: $t = 1 \mu\text{sec}$

$C_L = 0.005 \mu\text{F}$

$V_T = 1 \text{ volt}$

$V = 50 \text{ volts}$

Determine: R by Eq 1

$$I = \frac{0.005 \times 1}{1} = 0.005 \text{ A}$$

Since $V \geq 50V_T$

$$R = \frac{V}{I} = \frac{50}{0.005} = 10,000 \text{ ohms}$$

The use of C_{AC} is to provide AC coupling into the chronograph if required. This example considered the value of the breakwire resistance to be low in comparison to R . Since the length of wire for the two breakwire circuits usually will be similar, the signal delays will be similar and the timing error will be less than that caused by either one alone

Make System

The make-circuit consists in principle of two conductors, separated by an insulator, which are connected by the passage of the projectile. In practice, the system consists of a sandwich of sheets of aluminum foil glued on Styrofoam about one inch thick. Screen wire electrodes with hardboard or thin plywood as a separator also have been used successfully. The make circuit is especially useful in the measurement of terminal velocity where large size screens are necessary and replacement of breakwires difficult. Make screens as large as 20 ft square have been fabricated and used for many firings before being destroyed to the point where some contact is not made between the projectile and the two electrodes. Other materials have been tried including a sandwich of foil and cardboard; however, it was found that the insulator tended to extrude over the rear foil and prevent contact. When using a separator other than Styrofoam, it is advisable to leave an air space between the rear electrode and the insulator to provide good contacts. The circuit (Fig 4) used is similar to that used with the break circuit. The circuit has a time delay proportional to both the series resistance of the line and battery, and the capacitance of the line. For V large with respect to the triggering voltage and the line resistance R , small with respect to chronograph input resistance, the approximate time (t) required to reach

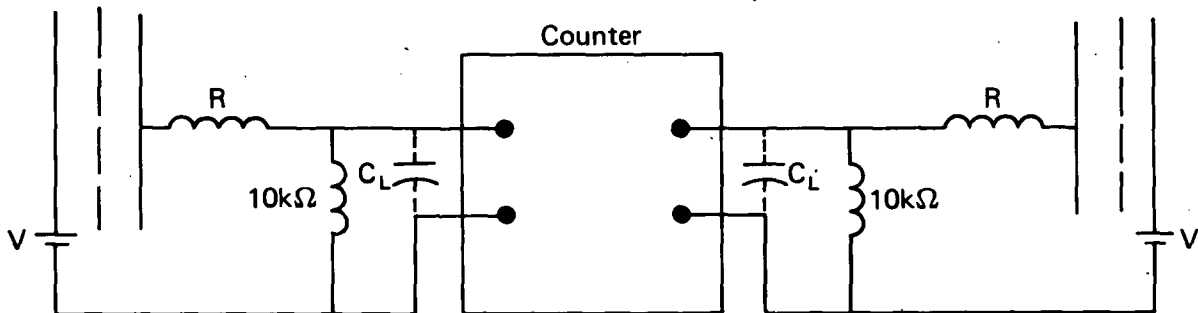

Fig 4 Make Circuit System

the triggering voltage V_T will be:

$$t = \frac{C_L V_T R}{V}, \mu\text{sec} \quad (\text{Eq 2})$$

where: t = time, μsec

C_L = capacitance of line plus make circuit, μF

V_T = trigger voltage, V

V = supply voltage, volt

R = series resistance of battery and line, ohm

An example of the application of Eq 2 follows:

Given: $C_L = 0.01 \mu\text{F}$

$V_T = 1$ volt

$V = 45$ volts

$R = 100$ ohms

Determine: t by Eq 2

$$t = \frac{0.01 \times 1 \times 100}{45} = \frac{1}{45} \mu\text{sec}$$

This is negligible compared to other circuit delays
Solenoid Coil Detectors

Probably the most used method for the determination of projectile velocity is the solenoid coil system where a magnetized projectile passes thru a coil of wire to produce a current, indicating its passage. The coil normally is wound about 200 turns of No 20 to No 24 magnet wire in a loop 20 to 30 inches in diameter, dependent on the diameter of the projectile. While originally wound loosely on a wooden frame, it was found that the excessive blast from a gun system caused enough vibration of the wire in the magnetic field of the earth to produce extraneous signals. Later coils were tightly bound and rigidly mounted on a wooden donut-shaped disc

It is necessary to magnetize the projectile in the proper direction prior to firing, or, if the projectile is nonmagnetic, to insert a magnet where it will not be excessively shielded by the material of the projectile. It is common practice to mount a cylindrical magnet in the nose so that at least 0.5 inch protrudes beyond the projectile nose

The design of the solenoid coil and the pulse shaping circuit is important to assure triggering of the chronograph at a known point in space. As shown in Fig 5, the wave shape of the signal from the coil is much like a sine wave. As the projectile approaches the coil, the increasing magnetic flux induces an EMF which reaches a maximum and then rapidly drops to zero as the projectile field is centered in the coil. The EMF then rapidly drops to some negative value and slowly returns to zero as the projectile passes out of the coil. It is advisable to use a shaping circuit to pick off the point of rapid negative rate of change, where the signal passes thru zero, as the trigger point for the chronograph

Proper polarity of coils and projectile magnetization may be checked by the use of a compass and a DC polarizing current of about 100 mA applied across the coils at the chronograph input. A rule of thumb prescribes that magnetization of the projectile should be strong enough to deflect a compass 45 degrees from the magnetic field of the earth when 4 inches from the nose of the projectile. This test also may be used after magnetization to assure relative consistency of magnetic field strength between projectiles. Projectiles normally are magnetized by placement in a coil equal to the length of

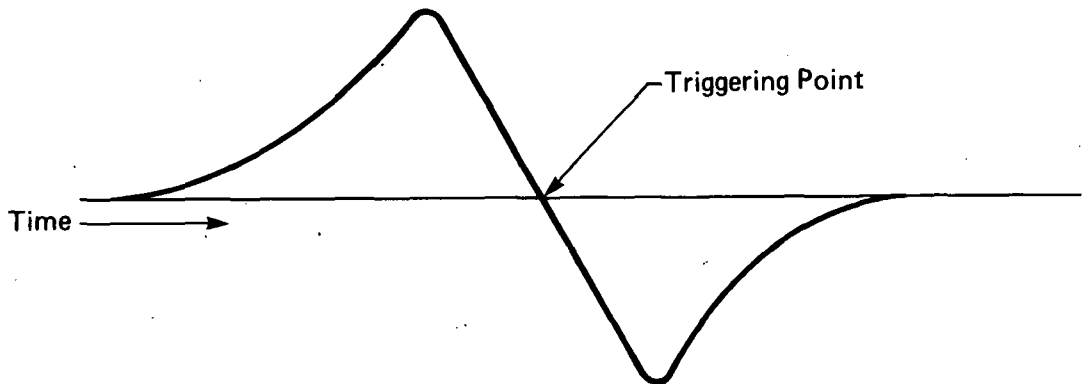

Fig 5 Solenoid Output Waveform

the major portion of the projectile thru which a steady or impulsive high current is applied
Sky Screen

Another method of detecting passage of a projectile in space is the sky screen. It has the advantages over other systems of not interfering in the visual path of the projectile, and permitting a number of velocities to be taken down range. The device consists basically of an optical system, collimating slit, and photomultiplier tube which produces a pulse when a rapid change in ambient light level occurs in its field of view. It has a fan-shaped field of view which will produce an error of about 0.2 to 0.5%, depending on the setup method, due to its spread. For muzzle velocity, it is normally positioned directly below the trajectory; while for time of flight measurement, it is placed off to one side to increase the field of view. It cannot be used on dark or hazy days, and cannot be pointed into the sun. Extreme care must be taken in positioning the unit since a small change in angle of the lens can cause a considerable error in baselines. One method to determine the sighting point of the device on flat trajectory firings is to suspend objects at points directly above the screens (when the screens are pointed vertically) on the trajectory. A meter measuring photomultiplier cathode current will dip when the screen is pointed directly at the object. Measuring the distance between objects will give the baseline

Radar Velocity Measurements

Microwave interference (Doppler radar) techniques may be used to measure the velocity and displacement of the projectile in the barrel and its velocity over its entire trajectory. The basic system consists of a microwave transmitter

that transmits a signal of known frequency in a beam along the axis of the projectile, and a receiver that receives a signal reflected from the projectile. Transmitted and received frequencies are compared, and the difference or Doppler frequency obtained is proportional to the projectile velocity along the axis of the microwave beam by the relationship:

$$V_R = \frac{\lambda}{2} f_d, \text{ fps} \quad (\text{Eq 3})$$

where: V_R = radial velocity, fps
 λ = radar wavelength, ft
 f_d = Doppler frequency, Hz

and $\lambda = \frac{c}{f_R}, \text{ ft}$

where: c = speed of light, fps

f_R = radar operating frequency, Hz

Since it is difficult to have the angle between the radar beam axis and the projectile trajectory equal to zero at all times, the radial velocity measured by the radar, ie, the component of velocity of the projectile in the direction of the radar beam, will be somewhat less than actual projectile velocity along the axis of its trajectory.

A typical setup is shown in Fig 6. The velocity V_R measured by the radar will at any point in space equal the actual projectile velocity V_P multiplied by the cosine of the angle θ , ie, $V_R = V_P \cos \theta$. In recoilless firing experiments, it obviously is not possible to locate the radar directly behind the gun. It, therefore, is necessary to locate the radar as close to the side of the gun as possible, considering blast effects on the equipment, to obtain good down range measurements. For accurate muzzle velocities or velocity of the projectile while in the barrel, the radar

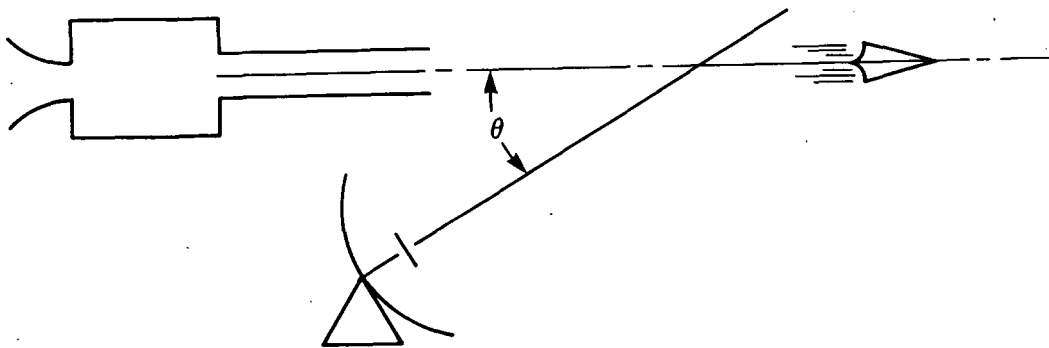

Fig 6 Radar Velocity Measurement Schematic

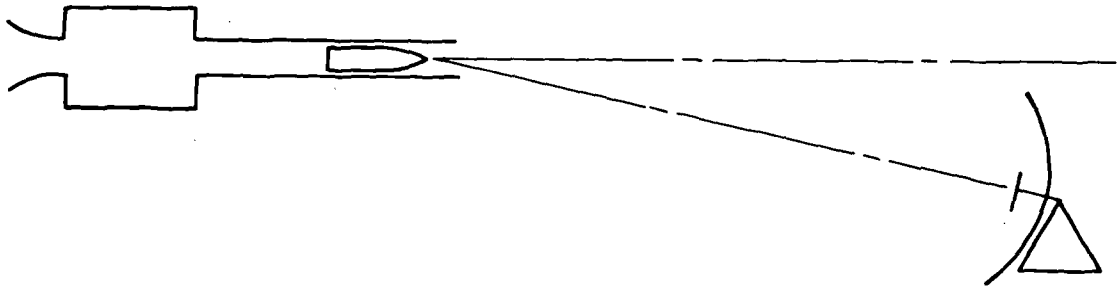

Fig 7 Radar Velocity and Displacement Schematic

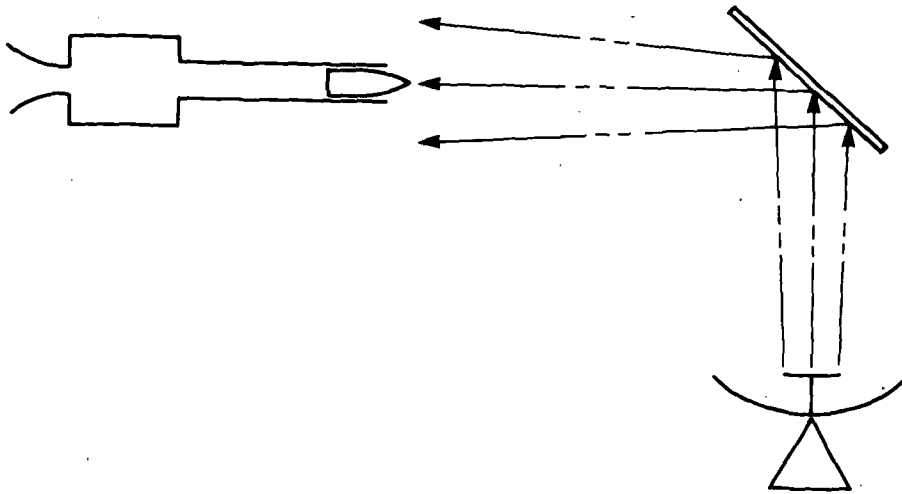

Fig 8 Radar Velocity and Displacement Schematic Using a Reflector

may be located just off the trajectory down range and pointed toward the gun

The radar systems produce a sinusoidally varying signal proportional to the radial velocity of the projectile which may be recorded by a number of methods. For recording the velocity over the complete trajectory, the Doppler signal may be converted by a frequency meter to a voltage proportional to frequency and, hence, velocity that may be recorded on an optical oscillograph as a trace of velocity versus time of flight. The signal also may be recorded digitally as a series of points containing the number of cycles of the Doppler signal occurring in given time increments, ie, a number of velocities measured during the flight of the projectile

The microwave system may be pointed toward the gun to measure velocity and displacement within the bore as shown in Fig 7.

To reduce the effect of radar off the axis of the projectile, the setup shown in Fig 8 has been used to advantage. Here a reflector made of foil backed with Styrofoam is placed about 25 ft forward of the muzzle at an angle to reflect the signal into the gun. The system is best aligned by placing a microwave detector connected to a meter in the gun tube and positioning for best signal strength as indicated on the meter. Since by Eq 3:

$$V_R = \frac{\lambda}{2} f_d$$

if also holds that

$$X = \frac{\lambda}{2} N$$

where: X = displacement of the projectile from rest, ft

N = number of cycles of the Doppler signal measured from time $t=0$

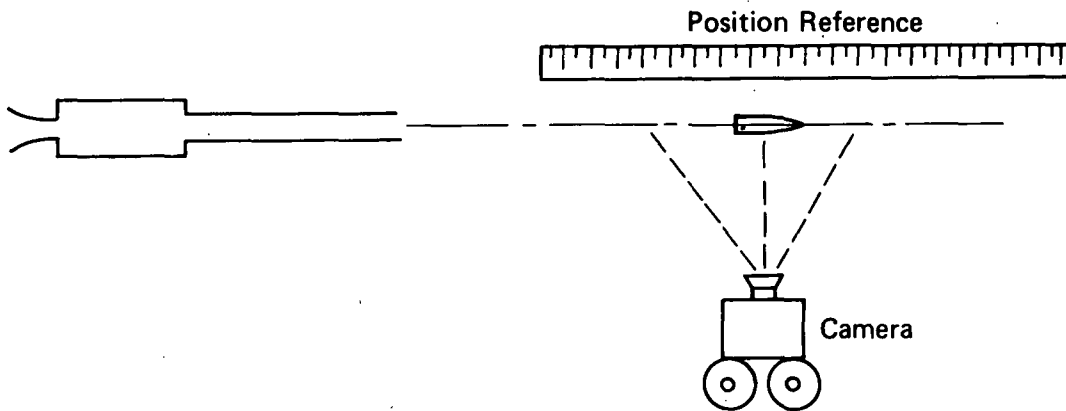

Fig 9 Photographic Method for Velocity Measurement

By recording the raw Doppler signal on an oscillograph, drum camera, or similar device, it is possible to obtain projectile displacement-time information

Photographic Methods

Velocity also may be measured by means of high speed (Fastex) motion cameras (see in Vol 2, C13-L to C19-R under "Cameras, High-Speed Photographic"). A typical setup is shown in Fig 9. A board several ft long with distance marks painted on its side is placed parallel to the trajectory as a distance reference. Parallax caused by the board being behind the projectile axis will cause an error in measurement. The correction may be determined by knowledge of the camera to object and camera to reference distances, and simple trigonometry. Timing marks normally are placed on the film for a time reference. While less accurate and more time consuming than previously described measurement techniques, photography can observe projectile integrity and launch characteristics as well as verifying velocity determined by other systems

Refs: 1) Anon, EngrgDesHndbk, "Elements of Armament Engineering, Part Two, Ballistics", AMCP 706-107 (1963), A-4 to A-16 2) Anon, EngrgDesHndbk, "Ballistics Series, Interior Ballistics of Guns", AMCP 706-150 (1965), 4-9 to 4-20 3) Anon, EngrgDesHndbk, "Recoilless Rifle Weapon Systems", AMCP 706-238 (1976), 8-5 to 8-15

Velox Gelatine. A WWI vintage blasting expl for hard rock manufd by the British South African

Explosives Co. It contained less NG than conventional blasting gelatine, and was intended to "husband stocks of glycerine" for military use
Ref: Marshall, Dict (1920), 99

Veltérines (or Weltérines). Expls based on ammonium trinitrocresylate (ATNC) patented in Fr in 1893 by L. Roux

Veltérines intended for use as proplnts contained either ATNC 40 and Ba nitrate 60, or ATNC 40, Ba nitrate 40 and K nitrate 20%. Those designed for blasting purposes contained ATNC and Na nitrate, to which was sometimes added up to 20% NG. For use in gaseous coal mines, formulations contained up to 93% Amm nitrate. Some of these were called "explosifs de mine, type C".

Veltérine C consisted of ATNC 50 and $KClO_3$ 50 p, to which could be added 15-20 p of NG. This expl was used successfully in Hg mines near Ras-El-Ma, Algeria.

Veltérine Belgique contained 83 p of Amm nitrate and 17 p of Dinitrobenzene

Refs: 1) Daniel (1902), 783 2) Colver (1918), 350-51

Veltex. The name given to a series of closely related NC compns prepd in 1957 at PicArnsn by the solventless process used for proplnts. These compns all contained a high percentage of solid HE, and were designed to be high mechanical strength machinable expls. They were investigated to determine the suitability of the *Holtex* type expl (see Vol 3, C396-L to C397-L) de-

veloped by Hispano Suiza of Switz, Fr and Spain, but for which the compn had not as yet been reported (Ref 1). Compns similar to Veltex No 448 (see below) and contg 60 to 80% HMX, with either NG or Triethyleneglycol dinitrate (qv) as colloiding agent for NC, were also prepd. In general, these compns showed lower heat stability than that of conventional HE compns

Veltex No 448 has the following compn:

HMX, %	70.0
Nitrocellulose (13.15% N), %	15.0
Nitroglycerin, %	10.7
2-Nitrodiphenylamine, %	1.3
Triacetin, %	3.0

Preparation: The prepn of this class of expl compns is illustrated by the method used for Veltex No 448: Place 675cc of w in a slurry kettle equipped with an agitator. Add 5.85g of 2-nitrodiphenylamine and agitate for several minutes to obtain dispersion. Then add 93.7g of w-wet NC (dry wt 67.5g) in small portions. Raise the temp to 48° and maintain this temp, but continue the agitation. A mixt of 48.2g of NG and 13.5g of triacetin is added over a 5-minute period, with the mixing continuing for an addnl 10 minutes at 48°. The HMX (350g) is added over a 5-minute period with agitation continued for 30 minutes at 48°. The slurry is cooled to room temp and filtered. The filter cake is dried to a moisture content between 8 and 12%. The incorporation of this mix is completed by rolling 50g portions at a temp of approx 90°. The finished colloid is then pre-heated on a heat table at 66°. Increments of 25g each are pressed at 6700psi for four minutes at 71°. A cylinder is then built up by pressing together four 25g increments for a dwell time of 15 minutes

Properties:

Molecular Wt:	281
Oxygen Balance:	
to CO ₂ , %	-26
to CO, %	-0.5
Color:	Orange
Density, g/cc: Pressed at 6700psi	1.72
Brisance, 200 Gram Bomb	
Sand Test, g:	66.4
Compressive Strength, lb/inch²:	2720
Compression at Rupture, %:	8.26

Work to Produce Rupture, <i>ft-lb/inch³:</i>	9.62
Detonation Rate, m/sec (calcd):	8500
Exudation, Dry Storage:	None
Friction Pendulum Test:	
Steel Shoe	Unaffected
Fiber Shoe	Unaffected
Heat of Combustion, cal/g:	2359
Heat of Explosion, cal/g:	1226
Heat Test, 90°C:	
% Loss, 1st 48 hrs	0.28
% Loss, 2nd 48 hrs	1.12
Explosion in 100 hrs	None
Machinability:	Excellent
Vacuum Stability Test:	
cc/40 hrs at 100°C	1.29
cc/29 hrs at 120°C	11 +
Young's Modulus:	
E', dynes/cm ²	0.24x10 ¹⁰
E, lb/inch ²	0.35x10 ⁵

Refs: 1) Anon, "Holtex-Hispano Suiza Explosive", US Air Intelligence Information Rept **IR-269-55** (4 May 1955) 2) Anon, EngrgDesHndbk, "Explosives Series, Properties of Explosives of Military Interest", **AMCP 706-177** (1971), 391-94 3) R. Meyer, "Explosives", Verlag Chemie, NY (1977), 313

Vender, Gelatine. A late 19th century Swiss expl consisting of "dinitro-acetin" with a little collodion cotton, and mixed with Amm nitrate
Ref: Marshall, Dict (1920), 99

Vending. Patented in 1882 under the name of "Dynamite Nitrobenzoique" the following mixt: Amm nitrate 50 to 75, NG 15 to 45, Mononitrobenzene 5 to 10 and NC 1 to 3 p
Ref: Daniel (1902), 783

Veratrol. See in Vol 5, D1302-L to D1303-L under "Dimethoxybenzene and Derivatives"

Vergé Explosivstoffe (Swiss). In 1913 A.E. Vergé patented a group of low-freezing Dynamites based on mixts of NG, Collodion Cotton, perchlorates or nitrates, and liq aromatic nitro-compounds (prepd by nitrating a mixt of iso-

meric Nitrotoluenes rich in Mononitrotoluene to the Dinitrotoluene stage) in which 20–25% of crude TNT was dissolved. Examples of these expls and their properties are given in Vol 6, G53-R to G54-L (Table G20) under “Gelatines, Vergé”, and in Vol 5, D1591 (Table 1) under “Dynamite”

Addnl Refs: 1) A.E. Vergé, SwissP 66131 (1913) 2) Ibid, BritP's 17127, 17128 & 17205 (1913) & CA 9, 380–81 (1915) 3) Naoúm, Expls (1927), 112

Vermiculite. Hydrated magnesium-aluminum-iron silicate capable of expanding six to twenty times in vol when heated to about 2000°F. Found in ores native to Montana, North Carolina, South Carolina, Wyoming, Colorado and South Africa. Typical analysis of Montana vermiculite ore is SiO₂ (38.64), MgO (22.68), Al₂O₃ (14.94), Fe₂O₃ (9.29), K₂O (7.84), CaO (1.23), Cr₂O₃ (0.24), Mn₃O₄ (0.11) and Cl (0.28%). Monoclinic crystals; pseudo-hexagonal characteristics, high porosity, liq adsorption of expanded vermiculite dependent on conditions and particle size, but can range from 200 to 500%. Sol in hot concd sulfuric acid; not sol in org solvents and w. CA Registry No [1318-00-9]

Cummings claims in his patent (Ref 1) that addn of expanded vermiculite to an expl compn controls d, and decreases shock sensy and ignitibility. Thus, AN (61), Na nitrate (23), paraffin (4), DNT (8) and expanded vermiculite (5 p) were mixed together into a compn which was found to be insensitive to the action of seven No 8 blasting caps and ignited at 136° only after 24 hrs (as compared to 7.33 hrs ign time for a similar compn contg a flaked corn product instead of vermiculite (Ref 1). Several other uses have been found for the mineral in other areas; viz, the prevention of explns or fires. For example, Pape and Siebel (Ref 2) suggest the use of vermiculite in a finely ground natural or thermally expanded form to prevent firedamp or dust explns in mining. The materials are claimed to be superior to the finely powdered stone dusts used hitherto. The inventor's explanation of the effect is that the particles are whirled into a pressure wave of an expln, and there absorb heat and dampen the blast wave, thus limiting the expln. In another patent, that of Strizhev-

skii et al (Ref 3), the use of 10 to 25 wt % vermiculite as the porous component in a mixt along with charcoal and kieselguhr is claimed to achieve the prevention of acetylene cylinder explns, among several beneficial effects. In the invention of Badami and Sharma (Ref 6), 4 to 15mm particle size vermiculite of 0.12 to 0.16 sp grav, is supposed to act as a fire extinguisher for flammable liqs along with equal or greater amounts of fire-inhibiting agents

Refs: 1) A.M. Cummings, “Explosive Composition Containing Vermiculite”, USP 2577110 (1951) & CA 46, 3764 (1952) 2) H. Pape & J. Siebel, “. . . Vermiculite for Prevention of Fire-Damp and Coal-Dust Explosions in Hard or Brown-Coal Mining”, GerP 1241393 (1967) & CA 67, 83762 (1967) 3) I.I. Strizhevskii et al, “Material for Preventing Acetylene-Cylinder Explosion”, RussP 198495 (1967) & CA 68, 51282 (1968) 4) Merck (1976), 1279 (No 9617) 5) CondChemDict (1977), 913 6) G.R.N.R. Badami & S.T.P. Sharma, “Fire Extinguishing Material for Extinction of Fires in Flammable Liquids”, IndianP 143818 (1978) & CA 92, 61292 (1979)

Verstarktes Chromammonit (Ger). Reinforced Chromammonite. Ger safety expl contg TNT 12.5, Amm nitrate 70.0, K nitrate 10.0, Amm chrome alum 7.0 and vaseline 6.5 p

Refs: 1) Colver (1918), 250 2) B.T. Fedoroff et al, “Dictionary of Explosives, Ammunition and Weapons (German Section)”, PATR 2510 (1958), 215

Vertes Explosives. Fr expls proposed in the last quarter of the 19th century. One typical formulation contained K chlorate 66.67, Picric Acid 19.03 and K ferrocyanide 14.30%. Another was conventional BlkPdr in which half of the K nitrate content was replaced by Amm Picrate. The latter expl was extremely unstable in storage
Ref: Daniel (1902), 784

Vesely. Brit machine gun. Joseph Vesely was a Czech citizen who assisted in the manuf of the Brit BESA machine gun just before WWII. In 1940 he submitted two sets of drawings of a

sub-machine gun that he had designed, but it was turned down as the decision had just been made to go ahead with the Lanchester and there was neither time nor any capacity for other models. Two years later Vesely tried again, this time with a prototype which he called the V-42. It was fairly conventional in appearance, being long and fitted with a wooden butt with a semi-pistol grip. A folding bayonet was permanently attached to the muzzle and lay back above the barrel jacket when not in use. It was operated by simple blowback, but there was no suggestion of advanced primer ignition, and the bolt closed on the breech before the spring-loaded firing pin struck the cap. To accommodate the extra power of the recoiling bolt, the return spring was very robust

The general construction was of sheet metal, stamped, wrapped and welded, but the memorable feature of the Vesely was the magazine. It held 60 rounds of 9mm (0.354") Parabellum ammo in two columns, one behind the other, each in a separate compartment. The front row fired first, while holding down the platform on the rear column. When the last round was fed from the front, the rear column was allowed to come up far enough to engage the bolt, and this column was then fed. There was thus no pause in the loading and feeding, and the rear column came into use without any action on the part of the firer. The rate of fire was 750 rounds/minute with a muzzle velocity of 411m/sec (1350ft/sec)

Quite naturally there were difficulties with this at first, and the sand and mud tests of the Ordnance Board proved it to be troublesome, but in the end it was perfected and rarely jammed. The Ordnance Board was not sufficiently impressed to recommend a change of weapon from the Sten, which in 1942 was well under way, and despite a 1943 version, the Vesely passed out of sight in favor of other, more promising designs. The double magazine has not been used since

Ref: B. Fitzsimons, Ed, "The Illustrated Encyclopedia of 20th Century Weapons and Warfare", Vol 23, Purnell Reference Books, Milwaukee (1979), 2560-61

VF. A type of Ballistite contg NC (N=13%) 50 and NG 50%. Its burning temp was 3810°.

See also in Vol 2, B8-R under "Brazil (Ballistite)"

Ref: A Alvaro-Alberto, AnaisAcadBrasilCienc 15 (1), 51-52 (March 1943)

Vibration, Ground, Generated by Blasting.

The following material is excerpted from the Blasters' Handbook, published by E.I. duPont de Nemours & Co (Ref 4):

When an expl detonates in a borehole, it generates an intense stress wave in the surrounding rock. This crushes the rock around the borehole up to about one borehole radius and permanently distorts and cracks it to several borehole diameters. A schematic diagram of this process is shown in Fig 1

When the intensity of the stress waves is reduced so that there is no permanent deformation of the rock, the stress wave propagates thru the rock in an elastic manner, that is, in such a manner that the rock particles are returned to their original position following the passage of the stress wave

Theoretical considerations have shown that for an expln in a spherical or infinitely long cylindrical borehole, only *compressional waves* are possible in an ideal material without boundaries. In nonideal materials and for cylindrical charges of finite length, however, *shear waves* can also be directly produced from explns

Compressional and shear waves are known as *body waves*. The compressional waves travel thru the rock by alternately compressing and dilating the particles of rock thru which they pass. These waves travel in the same direction as the particles they push together and pull apart. Their propagation velocity in rock typically exceeds 15000 ft/sec or more. Compressional waves can pass thru solids, liquids, or gases

The shear waves travel thru the earth by causing rock particles to vibrate sideways or at right angles to the forward direction in which the wave travels. Shear waves travel at about two-thirds of the velocity of compressional waves. However, unlike compressional waves, shear waves cannot pass thru liquids or gases because these materials have no shear resistance

When curved compressional and shear waves impinge upon interfaces, such as the earth's surface, a very complicated process takes place

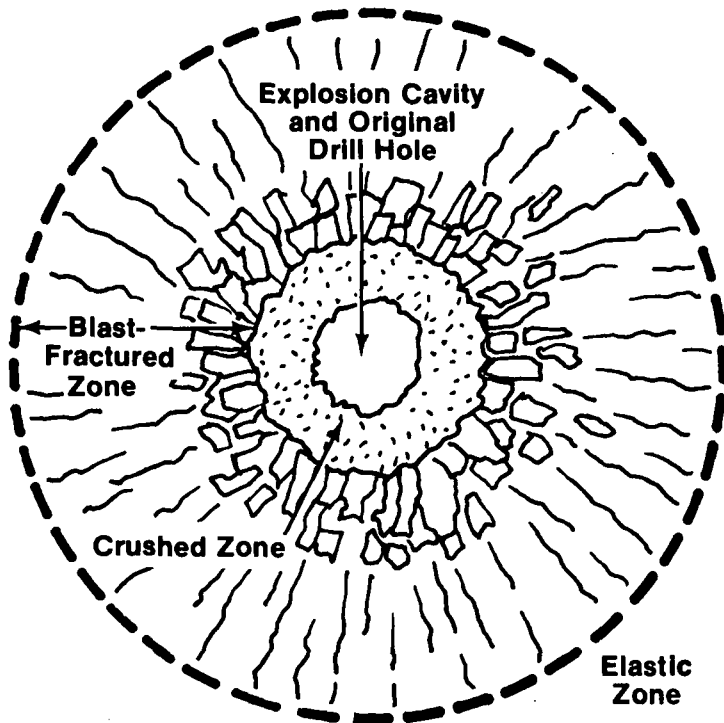

Fig 1 Schematic of the Fracturing and Deformation Around an Explosion in Rock (from Ref 4)

which gives rise to surface waves. The most common of the surface waves is called the Raleigh wave. Because the surface waves diverge in only two dimensions in contrast to the three-dimensional divergence of body waves, they decay more slowly with distance and frequently dominate the ground motion at distances of several hundred yards or more

In addition to divergence, nonelastic processes caused by the friction of particles upon one another cause seismic waves to decrease in intensity with distance. Studies have shown that high-frequency seismic energy is absorbed more readily than low-frequency energy so that the energy content of seismic waves at large distances is concentrated at low frequencies

Because the various kinds of seismic waves travel at different speeds and interact in a complicated manner with themselves and the material in which they travel, a blast which may finish detonating in a few hundred milliseconds or less can produce ground motion for several seconds at locations several hundred yards away. The lengthening of ground motion with distance is

enhanced by a process known as dispersion, whereby the different frequencies composing the various surface waves travel at different velocities

Production of Vibration Levels.

A simple power law formula has been found useful in relating the weight of the expl charge and its distance to the particle displacement, velocity, and acceleration

The form of the equation to determine peak particle velocity is:

$$V = KW^m R^{-n}$$

where: V = peak particle velocity (how fast the ground moves)

K = ground transmission constant, which is empirically determined based on the kind of rock surrounding the expl and at the receiving site where the particle motion is measured

m and n = empirical constants based primarily on the overall geology between the expln and receiving sites

R = distance between the expln and receiving sites

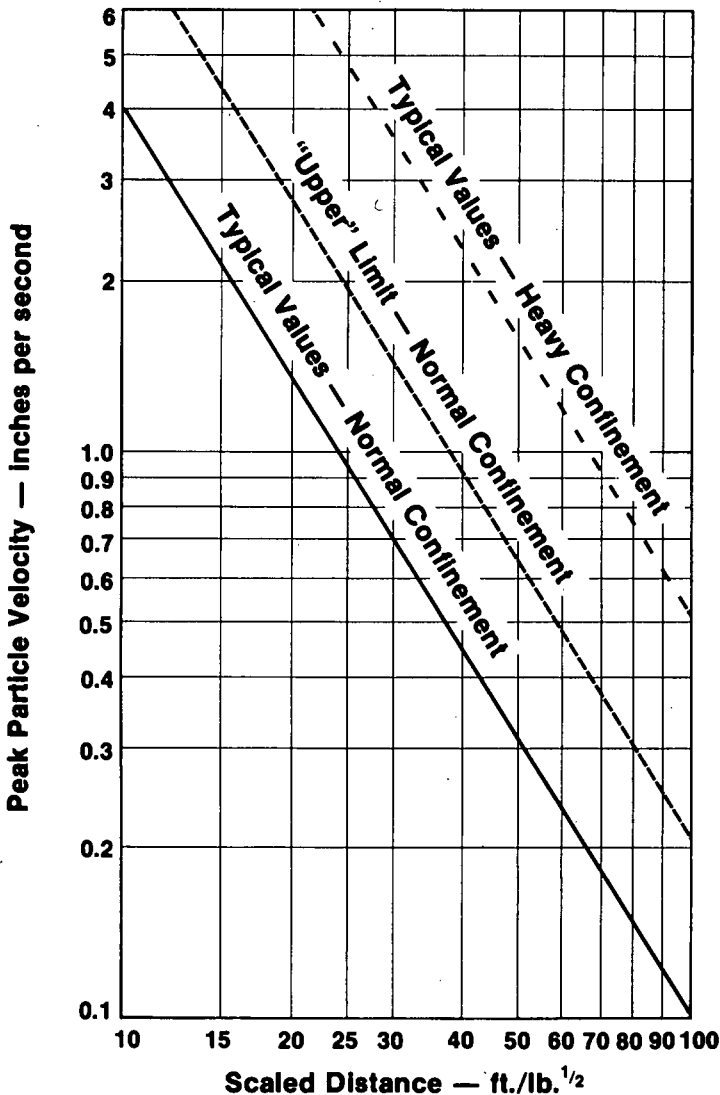

Fig 2 Typical values of peak particle velocity as a function of scaled distance for blasting to a free face. Charge weight is per-delay-period of eight msec or more. Blasts made under tight confinement may give values five times more than typical under normal confinement (from Ref 4)

Work by the USBuMines in ground motion transmission (Ref 2) produced two particularly significant results for the typical charge weights and distances found in surface blasting: 1) the constant m is equal to one-half of the constant n ; the power law equation then has only two unknowns and assumes the following form:

$$V = K (R/W^{1/2})^{-n}$$

where the quantity $R/W^{1/2}$ is known as the

scaled distance; and 2) the peak particle velocity depends on the maximum charge-weight-per-delay and not on the total charge weight, providing the delay interval is eight milliseconds or more

These results, combined with a large number of field measurements, have shown that the propagation equation can typically be expressed as:

$$V = 160 (R/W^{1/2})^{-1.6}$$

where: V = peak particle velocity in ips (inches per second)

R = distance between expln and recording sites in ft

W = maximum pounds-per-delay-period of eight milliseconds or more

Blasters can use this equation to estimate the peak particle velocity of a seismic wave or they can use the graph shown in Fig 2. For example: Determine the typical peak particle velocity from a normally confined blast with a maximum charge-weight-per-delay-period of 400 lbs at a distance of 1000 ft from the receiving site. The scaled distance, $R/W^{1/2} = 1000/400^{1/2} = 50$ corresponds to a peak particle velocity of 0.31 ips on the graph in Fig 2

It should be emphasized that the expression given in the above equation relating the peak particle velocity, charge-weight-per-delay-period, and distance provides typical values only for planning blasting projects in the absence of seismic data. For further detailed information on blasting situations where the above equation is not applicable, the measurement and interpretation of seismic waves, and techniques necessary to reduce blast vibration, the reader is referred to Refs 1, 3 & 4

Effects of Seismic Waves on Structures.

The intensity of seismic motion that can be tolerated by various kinds of structures must be established before acceptable charge weights at various distances can be determined. Obviously, the level of motion required to damage a structure depends upon its construction. For example, a steel-framed warehouse can tolerate a more intense seismic wave than a residential structure with plaster walls. Because plaster is the weakest of the most commonly used materials of construction, and because of the prevalence of such structures, most damage criteria are based on this type of structure

Table 1
Damage Levels from Ground Vibration as a Function of
Peak Particle Velocity of Ground Motion Near Structures (from Ref 4)

Peak Particle Velocity, inches per second	Nature of Damage
12	Fall of rocks in unlined tunnels
7.6	50% Probability of major plaster damage
5.4	50% Probability of minor plaster damage
2.8-3.3	Threshold of damage from close-in blasting
2.0	Safe blasting criterion for residential structures recommended by the US BuMines (Ref 2)
approx 0.02	Perceptible motion level to people

A number of studies have been made to correlate vibration levels with observed damage. These studies, included in Table 1, show that the amount of damage is related to the particle velocity of the ground motion peak

Refs: 1) M.A. Cook, "The Science of High Explosives", American Chemical Society Monograph Series, Robert E. Krieger Publishing Co, Huntington, NY (1971), 334-52 [Facsimile of 1958 edition with corrections] 2) H.R. Nicholls, C.F. Johnson & W.I. Duvall, "Blasting Vibrations and their Effects on Structures", USBuMines Rept B656, Supt of Documents, Govt Printing Office, Washington, DC (1971) 3) D.E. Siskind, J.J. Snodgrass, R.A. Dick & J.N. Quiring, "Mine Roof Vibrations from Underground Blasts, Pilot Knob, Mo", USBuMines Rept RI 7764, Publications Distribution Branch, BuMines, Pittsburgh, Pa (1973) 4) Anon, "Blasters' Handbook", Technical Service Sect, Expls Products Div, E.I. duPont de Nemours & Co, Wilmington, Del (1977), 423-34

Vibrational Spectra. See under "Spectroscopy of Energetic Materials" in Vol 9, S178-L ff

Vibration Tests. The Transportation Vibration-Temperature Test (Ref 3) is mandated by the US Dept of Defense in development and production of fuzes. It applies to designs which reached the development phase after 1 November 1973.

Those designs which were in the development phase prior to 1 November 1973 were subjected to the Transportation Vibration Test (Test 104) of Ref 1

The Transportation Vibration-Temperature Test is used to check the safety and operability of the fuze, since fuzes encounter a variety of vibration and temperature environments during logistic (land, sea and air) transportation conditions

Description of Test

1) The test consists of subjecting bare fuzes to vibration of specified frequencies, amplitudes and durations while being maintained at prescribed temperature conditions

2) The fuzes shall be completely assembled including all explosive elements which are part of the fuze design

3) *Procedure 1* (see below) is applicable to fuzes during development and the initial stages of production; *Procedure 2* (see below) is applicable to fuzes during production

Criteria for Passing Test

1) The fuzes must be safe and operable following this test

2) The decision that the fuzes have met or failed to meet the criteria is based on breakdown, inspection and appropriate tests, together with engineering judgment

Test Equipment

1) The vibration equipment required to conduct this test shall be any vibration machine which produces rectilinear simple harmonic

motion. The equipment shall be capable of vibrating in the frequency range of 5 to 500 Hz with a continuous logarithmic sweep, and have a displacement capability of one-half (1/2) inch peak to peak

2) Rigid fixtures which simulate the mounting of the fuze in service shall be used to mount the fuze to the vibration machine. The control accelerometer or accelerometers shall be mounted as close as possible to the fuze mounting point. The fixture shall be designed such that the transmissibility at any point on the fixture shall be less than two (2). The transverse motion of the input monitoring points shall be less than 100 percent of the input motion. The transmissibility and transverse motion of the fixture, loaded with fuzes or dummy equivalents, shall be evaluated thru the range of test frequencies (5 to 500 Hz)

3) Temperature conditioning equipment is required to establish and maintain the fuzes at the specified temperature during test

Test Procedures

Procedure 1

1) *Vibration Conditions*

The bare fuzes shall be mounted in the test fixtures. Vibratory excitation shall be applied along each of three (3) major axes: (a) the longitudinal axis, (b) a first transverse orthogonal axis, and (c) a second transverse orthogonal axis; The fuze axes should be defined by item specifications. If not, the fuze axes and the resulting vibration orientations (specific or random) shall be defined, and these definitions made a part of the test record. The two transverse axes and the fuze orientation (nose up or nose down) for longitudinal vibration shall be chosen, if possible, to expose the most critical or vulnerable positions of the fuze to the vibration, while maintaining the orthogonality requirement. The frequency shall be swept logarithmically from 5 to 500 to 5 Hz in 60 minutes with the following accuracies: Sweep Time $\pm 3\%$; Frequency ± 1 Hz from 5 to 50 Hz and $\pm 2\%$ from 50 to 500 Hz. The vibration test durations at each temperature shall be twelve (12) hours (4 hours per axis). The test levels of Table 1 shall be used:

Table 1

Frequency (Hz)	Test Level
5-11	0.4 inch displacement, peak to peak
11-37	2.5g acceleration, peak
37-52	0.036 inch displacement, peak to peak
52-500	5.0g acceleration, peak

2) *Temperature Conditions*

Three (3) conditions are required for the test: (a) $73^{\circ} \pm 18^{\circ}$ F, (b) 160° F, and (c) -65° F.

There shall be three (3) groups of fuzes, one group for each temperature. The fuzes and their vibration test fixtures shall be pre-conditioned at the test temperature for a minimum of four (4) hours prior to the vibration test, and shall be maintained at that temperature for the duration of the test. If data exists showing a different stabilization time, then this shall be used instead of the four (4) hours. After changes of fuze orientations, the external surface temperature of the fuze shall be returned to the specified temperature before the test may be resumed

3) *Examination*

Upon completion of vibration, examine the fuzes for conformance with "Criteria for Passing Test" (above)

Procedure 2

1) *Vibration Conditions*

The vibration test levels for Procedure 2 shall be the same as for Procedure 1 with a total test time of six (6) hours (2 hours per axis)

2) *Temperature Conditions*

The fuzes shall be vibrated at room temperature

3) *Examination*

Upon completion of vibration, examine the fuzes for conformance with "Criteria for Passing Test" (above)

Related Information (not a mandatory part of this test).

1) If the fuze design includes a booster, an inert booster of equivalent weight and size may be substituted at the discretion of the design engineer

2) *Vibration Levels*. The test levels utilized in this test are a standard envelope of transportation conditions in commonly used vehicles.

The bibliography offers additional guidance for unusual vehicles and for extreme operational environments (also see Ref 2)

3) Sequential testing may be considered during development in addition to Procedure 1. The vibration test durations may be six (6) hours (2 hours per axis) at room temperature and three (3) hours (1 hour per axis) at each temperature extreme for a total test time of 12 hours for the three (3) temperatures. The temperature sequence of room temperature; -65°F ; and 160°F is recommended

4) *Temperature Conditions.* Temperature conditions of -65°F and 160°F are the extremes generally used to evaluate the suitability of a fuze to withstand most temperature environments. Values beyond these extremes may be encountered at a few particular geographic locations. **MIL-STD-210** should be consulted for known extremes at various world points

5) *Mechanical Vibration Effects.* If the safety condition of the fuzes is in doubt, inspection by radiography is recommended prior to disassembly and inspection. In general, the results of vibration tests are manifest in varying degrees of abrasion or loosening of components. Distinction between reasonable wear and borderline or serious damage, significant in terms of safety or operability, must be made on the basis of engineering judgment, including studies under dynamic operating conditions where practicable

Bibliography (not a mandatory part of this test).

1) **MIL-STD-210**, "Climatic Extremes for Military Equipment", Supt of Documents, Washington, DC 20402

2) **MIL-STD-810B**, "Environmental Test Methods", Seg (SEPS), Wright-Patterson AFB, Ohio 45433

3) **MPT 4-2-804**, "Laboratory Vibration Tests", US Army Test & Evaluation Command, Aberdeen Proving Ground, Maryland 21005

4) **AR 70-38**, "Research, Development, Test and Evaluation of Material for Extreme Climatic Conditions"

Note: Bibliography item (2), Method 514.1, "Vibration", specifies tests for equipment which may be used in a variety of military applications. The equipment is categorized according to the vehicle in which it will be installed or transported as follows: (a) equipment installed in airplanes and helicopters; (b) equipment

installed in airplanes, excluding helicopters; (c) equipment installed in helicopters; (d) equipment installed in air launched missiles; (e) equipment installed in ground launched missiles; (f) equipment installed in ground vehicles; (g) equipment transported by common carrier, land or air; (h) ground equipment, excluding category (f); and (i) shipboard and amphibious equipment or when a ship is the common carrier

Refs: 1) Anon, "Transportation Vibration, Test No 104", Military Standard, "Environmental and Performance Tests for Fuze and Fuze Components", **MIL-STD-331** (10 January 1966) [Superseded by Ref 3] 2) Anon, *Engrg Des-Hndbk*, "Environmental Series—Part Three—Induced Environmental Factors", Chapt 4 (Vibration), **AMCP 706-117** (January 1976), 4-1 to 4-84 3) Anon, "Transportation Vibration-Temperature, Test No 119", Military Standard, "Environmental and Performance Tests for Fuze and Fuze Components", **MIL-STD-331A** (15 October 1976)

Vibrite. See under "Italian Explosives and Related Items" in Vol 7, I181-R

Vibrogel 1 and Vibronite B. Trade names for powder form expls and blasting agents distributed in the USA by Hercules Inc especially for seismic prospecting. Vibrogel 1 is loaded in plastic hoses, Vibronite B in threaded cans. For Vibronite B, cap-sensitive primer expls, loaded in the same threaded cans, are available. Density, 1.03 to 1.17g/cc; weight strength, 65%

Refs: 1) R. Meyer, "Explosives", Verlag Chemie, NY (1977), 313 2) C.E. Gregory, "Explosives for North American Engineers", 2nd Ed, Trans Tech Publications, Rockport, Maine (1979), 73

Vibronite. A Hercules Inc seismographic blasting agent packaged in $2'' \times 5\frac{3}{4}''$ and $2\frac{1}{2}'' \times 4\frac{1}{2}''$ one-pound metal cans, with built-in female thread in the top, male thread in the bottom for making a continuous length, and is packed 50 cans to a 50-lb case. Vibronite S comes in green cans, Vibronite S-1 in blue cans, with the following performance parameters:

	Velocity (ft/sec)	Measured Weight Energy (ft-lb/lbx10 ⁶)
Vibronite S	10200	0.85
Vibronite S-1	14250	1.08

Ref: S.L. Hermann, "Explosives Data Guide", Explosives Research Institute Inc, Scottsdale, Ariz (1977), 108

Vickers. Brit machine guns. The firm of Vickers began in Sheffield as steel makers and from this it moved into shipbuilding and opened yards on the Tyne and in the northwest of Engl. A factory was constructed at Erith on the Thames, and it was here that the Maxim gun was manufd. Hiram Maxim (see Vol 8, M45-R) needed a partner with a manufg base for the production of his gun, and in 1883 he entered into an agreement with Albert Vickers. In time the firm became Vickers, Son and Maxim. The Erith factory was largely concentrated on the Maxim gun, although there were also other products. Vicker-built Maxims were sold all over the world, and were accepted into the Brit Army in 1891. At the same time as the rifle-caliber guns were being made, the factory also built another Maxim design, the 1-pounder *pom-pom*. The name pom-pom was an onomatopoeic derivative of the distinctive sound of its slow and rhythmic rate of fire. The pom-pom was adopted by several nations mainly because the idea of a shell-firing machine gun was extremely popular at that time

The pom-pom was a large machine gun of 37mm (1.46") caliber firing expl shells weighing 0.45kg (1 lb). It was not a complete success, but several were bought by the Boers and used against the Brit Army in the 1899-1901 war. It was not capable of sustained fire like the Maxim gun, and its bulk was not easy to hide, but a burst of pom-pom shells could do plenty of damage to unprotected troops in the open

Vickers saw that the Maxim gun was capable of improvement and development, and they brought out their first developed version in 1904. Much weight was saved by careful stress calcns, since the Maxim had been designed by more or less empirical methods, and was needlessly heavy, but the use of high grade steels and aluminum

also brought the weight down. The toggle action was turned upside down which reduced the depth of the receiver by nearly half, and in the end the Vickers-Maxim was roughly 25% lighter than the original gun. It was adopted by the Brit Army in 1912, and in WWI earned an enviable reputation for reliability and effectiveness. Complete battalions were formed, armed with nothing else but the Vickers, and the idea was revived in WWII. It remained the standard support machine gun of the Brit Army until the mid 1960s and is still in use in small numbers in ex-Commonwealth countries. It was also mounted in aircraft, where it was air-cooled, in ships and in armored vehicles. A heavy version was made in 0.5" (12.7mm) for tank use in the 1920s and 1930s, and in WWI a few were made to take the French 11mm (0.43") cartridge for use in shooting observation balloons from scout aircraft

Despite its advantages of reliability and long life there were drawbacks to the Vickers - it was heavy and demanded a crew of three men to move it, as well as a supply of water and men to make up belts of ammo. Therefore, the company purchased the Berthier design for a light machine rifle and developed it into a light machine gun. This appeared in 1930 and was advertized as a general-purpose machine gun, for use in the front line in direct support, and also as a support gun in place of their belt-fed gun. The Vickers-Berthier (VB) was a simple gun, magazine fed and in many ways not unlike the Bren which the Brit Army chose in its stead. However, the VB was adopted by the Indian Army and was used quite widely in WWII, where it fulfilled all the promises made by its designers. It was adaptable as an aircraft gun for use by the observer from an open cockpit. From this idea arose the notion of increasing the rate of fire and giving it a larger magazine. It was fitted with a flat round pan magazine in which the rounds were pushed round by a clock spring, so that the pan itself did not rotate, and the rate of fire went up to 900 rds/minute. The pan magazine held 100 rounds, though there was a 60-round version, and this gave a useful number of bursts. Unfortunately this version, which became known as the Vickers Gas-Operated Gun (VGO), fared little better than the VB, since soon after it came into service open cockpits went out and turrets were introduced, armed

with belt-fed Brownings

Some VGOs were given to the army and mounted on vehicles for patrol work in the desert. In this role they were highly successful and there were still some in use in the early 1960s. The VB and VGO were light gas-operated machine guns with air-cooled barrels and the usual variety of accessories such as a tripod and spare barrels. Very few were sold abroad and the venture must have lost money. At the time Vickers tried to interest their clients in the Pederson rifle which was to be made under license. Nothing came of that, and the firm then gave up the idea of designing and making small-arms, except for a trickle of orders for the water-cooled gun

In the late 1920s the idea of the pom-pom was revived for anti-aircraft use, and also for possible mounting in aircraft. The latter idea led to the Vickers S gun, but the pom-pom was developed into a 40mm (1.57") automatic weapon firing a 0.9kg (2lb) shell fed by a belt. The rate of fire was fairly low and the army bought a few for defense of fixed installations such as dockyards, but it was not a success in this role. However, when clustered into groups of six or nine it proved to be a most effective AA weapon against low-flying aircraft, and was adopted by the navy for warship defense. The normal grouping was nine guns in one large mounting which produced a rate of fire of over 1000 rds/minute. The only drawback was the limited range of the short-cased round

Ref: B. Fitzsimons, Ed, "The Illustrated Encyclopedia of 20th Century Weapons and Warfare", Vol 23, Purnell Reference Books, Milwaukee (1979), 2561-62

Victor Powder. A WWI era Brit coal mining expl made by Nobel's Explosives Co. There were two varieties at one time on the Permitted List:

Date of Permit	No 1 5-13-14	No 2 1-15-15
Amm nitrate, %	68	67
K chloride, %	14.5	—
Na chloride, %	—	15
NG, %	8.5	9
Woodmeal, %	9	9
Limit charge, oz	18	16
Power (swing of BalPend)	2.96"	2.63"

Ref: Marshall, Dict (1920), 99-100

Victoria Powder. See under "Dahmen, Johann, von" and "Dahmenit A" in Vol 3, D1-R

Victorite. See under "Explosive B&T No 21" in Vol 6, E395-L

Note: The same name was given to a commercial expl contg Picric Acid 50, K chlorate 40 and castor oil 10 p. Some varieties also contained K, Na or Ba nitrate and charcoal. The mixts were extremely sensitive to friction, and were therefore not "permitted" in Engl

Refs: 1) Daniel (1902), 785 2) Colver (1918), 323 3) Stettbacher (1933), 286

Vieille, Paul (1854-1934). Fr scientist who was Secretary and later, as successor to Berthelot, President of the Fr Powder Explosives Commission. Shortly prior to his death, Vieille was named Inspector Général des Poudres. In 1884 he invented *Poudre B* (see Vol 2, B1-L to B2-L), the first progressive burning smokeless powder. He was the author of classic researches on gun barrel erosion (see Vol 5, E113-L). Vieille invented a so-called "crusher enregistreur" (crusher gage) (see Vol 3, C331-L & R), and devised a stability test for proplnts in 1896. In this test the sample is heated at 110°C (230°F) in the presence of a strip of litmus paper, and is then exposed to air at room temp overnight, after which the cycle is repeated. This treatment is continued until the litmus paper turns red within one hour. The overall duration of the heating operations thus performed is a measure of the stability (Refs 1 & 3)

The advantage of the *Vieille Test* consists of the fact that when the proplnt is periodically exposed to the atmosphere, it can reabsorb moisture, which means that the decompn takes place under realistic conditions. The test is now much less frequently applied, ever since a proplnt manufd with pentanol as solvent, which had been tested by this method, had decompd on board two warships, which were sunk by the resulting expln in 1911. The Vieille test today is used only in Fr and Belg (Ref 6)

Vieille also devised a "coefficient d'échange" test for NC stability (see Vol 3, C389-L), and is

known for "Vieille's Law", $R=ap^n$, which indicates that the burning rate of a proplnt (R) depends markedly on the pressure (p). The exponent, n, is known as the pressure index of the proplnt, and is usually in the range 0.5 to 0.8; a is a const. Vieille's Law is obeyed well by the older types of single and double base proplnts (Ref 5)

Refs: 1) Barnett (1919), 224 2) Anon, *MemorArtillFranc* 13 (1934), IX–XV (obituary) 3) Reilly (1938), 78 4) Davis (1943), 294 5) Fordham (1966), 194 6) R. Meyer, "Explosives", Verlag Chemie, NY (1977), 314

Vieille Test. See under "Vieille, Paul" above

Vigilant. Brit man-portable wire-guided anti-tank missile system. In its simplest configuration the system comprises a launcher box contg one missile, a sight controller, a pocket battery, and a length of interconnecting cable. The launcher box is set on the ground with the missile inserted, pointing in the direction from which a threat is anticipated, and the operator, who carries the sight controller and its associated battery, takes up a suitably unobtrusive position where he has a good field of view. This position may be up to 63m from the launcher box. Thus positioned, the operator can engage targets over arcs of fire of $+10^\circ$ in elevation and $+35^\circ$ in azimuth, and at ranges of from 200 to 1375m. The missile warhead is of hollow-charge design, weighing in excess of 5kg with fuze

Vigilant is now obsolete and has not been made for some years. For the Brit Army it was a useful introduction to the problems of small missile training and use, and when it was introduced (1963) it was notable for the fact that it used velocity control instead of the then more usual acceleration control

Refs: 1) J. Weeks, Ed, "Jane's Infantry Weapons, 1979–80", Fifth Ed, Franklin Watts, NY (1979), 523 2) R.T. Pretty, Ed, "Jane's Weapon Systems, 1979–80", Tenth Ed, Franklin Watts, NY (1979), 36–37

Vigorine. An expl patented in 1875 by L.A. Bjorkmann of Sweden consisted of "Nitroline" 40 (see Vol 8, N136-L), Cellulosa 22 (see Vol 8, N136-L), K nitrate 22, and K chlorate 16%. This expl was sometimes called "Vigorite", although this is, accdg to Salvati, incorrect (Ref 1, p 785 & Ref 2, p 387). A compn contg Nitroline 30, Cellulosa 10, K nitrate 20, K chlorate 20, sawdust 10 and peaflour 10% was sometimes called "Vigorine Américaine", even though it was Swedish in origin

Refs: 1) Daniel (1902), 72–73 & 785 2) Giua, *Trattato* 6 (1959), 387 & 392

Vigorit. Brit expl contg Amm nitrate 76, K nitrate 10, K perchlorate 2, resin 2, and nitrated hydrocarbons 10%. It was claimed to be equal in power to Picric Acid and some Dynamites
Ref: D.H. Rohne, *SS* 1, 109 (9106) & *CA* 2, 706 (1908)

Vigorites (Vigorites Américaine). Expls manufd at the end of the 19th century by the California Vigorite Powder Co. One consisted of NG 30, K nitrate 7, K chlorate 49, woodflour 9, and Ca or Mg carbonate 5%; another variety contained NG 43.75, K nitrate 18.75, K chlorate 17.50, woodflour 11.25 and Ca or Mg carbonate 8.75%

The Hamilton Powder Co of Canada manufd the following mixture, also called "Vigorite": NG 30, Na nitrate 60, NC 5 and charcoal 5%. A serious expln of this dangerous mixt took place in 1879 on the Grand Trunk RR in Ontario, killing two persons and destroying many freight cars

Refs: 1) Cundill (1889) in *MP* 6, 111 (1893) 2) Daniel (1902), 786 3) Marshall, *Dict* (1920), 100–01 4) Van Gelder & Schlatter (1927), 635–36

Viking Powder. A WWI era Brit coal mining expl manufd by Nobel's Explosives Co and used extensively. There were two varieties at one time on the Permitted List:

Date of Permit	No 1 1-15-15	No 2 1-15-15
Amm nitrate, %	59	67
NG, %	10	8.5
Woodmeal, %	10	8.5
Na chloride, %	20	15
Mg carbonate, %	1	1
Limit charge, oz	26	18
Power (swing of BalPend)	2.44"	2.59"

Refs: 1) Marshall, Dict (1920), 100 2) Urban-
ski 3 (1967), 405

Vincent, Thomas K. (1895–1956). Brigadier General, US Army. During his long military career as an officer of the Army Ordnance Corps, Gen Vincent served with distinction in assignments of broad responsibility during the First and Second World Wars, in the Korean War, and thru all the intervening years. His technical experience in artillery design, proving ground administration, and rocket and missile development was unusual. No other officer in the long and memorable history of Army Ordnance had served in such fields with greater vigor or had more widespread responsibility. He concluded his military service in 1954, as Commanding General of Redstone Arsenal, the Army Ordnance Missile and Rocket Center. Immediately thereafter he became associated with the national headquarters staff of the American Ordnance Association in Washington, DC, where he was in charge of the operations of Technical Divisions and committees

Ref: Anon, "Industrial Preparedness", American Ordn Assoc; Washington, DC (Oct 1956)

Vincennite. Poisonous mixt used by the Fr in WWI in chemical shells. It consisted of hydrogen cyanide 50, As trichloride 30, Sn tetrachloride 15, and chloroform 5%. There was difficulty in obtaining toxic concns in field use because of the extreme volatility of the hydrocyanic acid

Ref: J. Bebie, "Explosives, Military Pyrotechnics and Chemical Warfare Agents", Macmillan Co, NY (1943), 160

Vinsol. A Hercules proprietary expl contg Amm

nitrate 94 and a rosin derivative 6%

Ref: J.D. Hopper, "Study of Vinsol Ammonia Explosive Received from Hercules Powder Co", PATR 984 (1939)

Vinyls. (or Vinyl compounds). Compds having the characteristic double-bonded grouping in their structure; viz, (CH₂=CH-). A more general structure for the class can be shown as

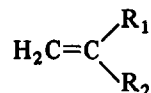

where R₁ and R₂ represent hydrogen, alkyl, halogen or other substituents which can react or add to another similar compd to form an addition type polymer. This structure can also become part of a diene grouping (see in Vol 5, D1223-L). Specific typical compds of this genus are acrylonitrile, vinyl acetate, vinyl chloride and vinylidene chloride. The vinyls are highly reactive, polymerize easily, and are the basis of a number of important plastics. Their polymerization reactions can be extremely violent (for examples see in Vol 8, P343-L to P345 under "Polymerization, Violent"). This class of compds is very useful as energetic materials or as binders for energetic materials. Not only the polymers, but the monomers can be used in expls, proplnts and pyrots. Hence, the pertinent compds of this category, both monomer and polymer, are presented next

Refs: 1) E.C. Leonard, Ed, "Vinyl and Diene Monomers", Parts 1, 2 & 3, Wiley-Interscience, NY (1970–71) 2) Anon, "McGraw Hill Encyclopedia of Science and Technology", Vol 14, McGraw Hill, NY (1977) 3) Cond-ChemDict (1977), 917

2,2-Dinitropropylacrylate. See in Vol 8, N139-R to N140-R

Divinylacetylene. See in Vol 5, D1525-R to D1526-L

Divinylbenzene (DVB or Vinylstyrene). See in Vol 5, D1526-L and the following *Addnl Refs*:
1) S. Patai et al, "Kinetics of the Oxidation of Solid Organic Substances by Solid Oxidants at

High Temperatures", Proc 4th Intl Symp on the Reactivity of Solids, J.H. DeBoer et al, Eds, Elsevier, Amsterdam (1960) [In vacuo heating to 400° resulted in explns of several compns including the copolymers DVB (40) and p-ethylstyrene (60%) (1 p) and K perchlorate (2.5 p) in separate mixts with Fe sulfate (2) and V pentoxide (2%)] 1a) E.C. Leonard, Ed, "Vinyl and Diene Monomers", Part 2, Wiley-Interscience, NY (1971), 543 [Expl limits for a comml DVB mixt (m-DVB [36.4], p-SVB [18.6], m-ethylvinylbenzene [25] and p-ethylvinylbenzene [13%]) in air is reported as 1.1%] 2) E.L. Lista, "Solid Porous, Coated Oxidizer, Propellant Compositions", USP 3830672 (1974) & CA 82, 32918 (1975); Anon, "Solid Propellant Compositions", NethPApplic 7404482 (1975) & CA 85, 179847. (1976); Anon, "Solid Oxidant Based on Inorganic Ammonium Salt", FrP 2266674 (1975) & CA 86, 45357 (1977); all of these patents are from the Aerojet General Corp [High, uniform burning rate control of antimissile missile proplnts is claimed by coating the amm perchlorate oxidizer particles with DVB-alkylamine adduct and then polymerizing the coating. Thus, a slurry of 500g of dry porous AP in 1ℓ hept at 60° was mixed with 40cc of 5% DVB-propyleneimine adduct in hept, stirred 4 hrs, and the salt then sepd and dried, giving the polymer coated AP. A std proplnt formulation contg 52% conventional AP and 20% of the coated porous AP had a Crawford burning rate of 15.1cm/sec (a 7.5 sq cm strand burned at 140kg/sq cm pressure), while a formulation contg 52% conventional AP and 20% uncoated AP gave a value of 8.5cm/sec and one contg 72% conventional AP, 7.5cm/sec]

Divinyl Ether. See in Vol 5, D1526-L & R and the following *Addnl Ref*: G.F. D'Alelio, "Beryllium-Containing Polymeric Propellant Compositions", USP 3479235 (1969) & CA 72, 23044 (1970) [The inventor suggests use of a divinyl eth polymer contg Be as a means of obtg solid polymers, useful as proplnts, which have the high energy content of Be compds but are much safer to handle than the pyrophoric liq Be alkyls. Thus, a mixt of 67 p of diethyl Be and 100 p of hexane was treated with 162 p of divinyl eth, heated in N₂ to evap the hexane, heated again at

100° for 72 hrs, and then cooled. The solid polymer is then ground with an equal amt of AP to prepare a compn which is reported to have burned vigorously when ignited and to have excellent proplnt thrust properties]

Ethylacrylate and Derivatives. See in Vol 6, E201-R to E202-R

Ethylvinyl Carbinol. See in Vol 6, E339-R

Ethylvinyl Ether (Vinylethyl Ether). See in Vol 6, E339-R

Ethylvinyl Hexoate (Vinyl-2-ethyl Hexoate). See in Vol 6, E339-R

Ethylvinylhexyl Ether (Vinyl-2-ethylhexyl Ether). See in Vol 6, E339-R to E340-L

Ethylvinylpyridine. See in Vol 6, E340-L

MethylTrifluorovinyl Ether.

CH₃.O.CF:CF₂, C₃F₃H₃O; mw 112.05; OB to CO₂ -92.81%; liq; bp 10.5 to 12.5°. Prepn is by reacting anhydr Na methoxide with anhydr dioxane in a stainless steel bomb pressured to 300 psi with tetrafluoroethylene at 100° under agitation. The crude product is distld off at 21-45° using a 12" Vigreux column. It is then redistld thru a 3' low-temp column packed with glass helixes. The fraction boiling at 10.5 to 12.5° is collected as the pure product. The yield is 58%. According to Anderson (Ref 3), the ether is an expl. Ign occurs either thru the use of a hot wire or an electric spark, producing a v violent expln. The explosiveness of this perfluorovinyl ether is considered to be greater than acetylene

Refs: 1) Beil, not found 2) S. Dixon, "Chemical Compounds and Process for their Preparation", USP 2917548 (1959) & CA 54, 5474 (1960) 3) A.W. Anderson, "Explosive Reaction Warning", C&EN 54 (16), 5 (1976)

2-Methyl-5-Vinyl Tetrazole Polymer. See in Vol 9 under "Tetrazoles"

Tetravinyl Lead. See in Vol 9

1,1,1-Trinitro-2-Propyl Acrylate. See in Vol 8, P479-L & R

Vinyl Acetate and Polyvinylacetate. See in Vol 8, P353-R to P354-R and in the following *Addnl Refs*: 1) W.S. Baker, "Coating Composition for Combustible Cartridge Case", USP 3293056 (1966) & CA 66, 39502 (1967) [The inventor claims several distinct advantages in using cotton gauze coated with polyvinylacetate to produce a combustible cartridge case; ie, redn of excessive pressure and flash. The vinyl resin is dissolved in a suitable solvent to which amm perchlorate (AP) is added. Thus, AP (420) and a soln of vinylacetate (1000) in methylethylketone (960) is added to a soln of "Staybelite 10" (800) in methylethylketone (2400g) to form the coating agent which is used to impregnate the cotton gauze used for cartridge casing by means of a std coating appar. The inventor reports that the ballistic results obtained from the use of such

cases showed a significant decrease, not only in max pressure, but also in the rate of pressure rise and time to peak pressure. Additionally, K perchlorate can be used instead of AP without resulting in adverse ballistic effects. There is also a distinct redn in flash] 2) S. Horie et al, "Vinyl Acetate", JapP 7039523 (1970) & CA 74, 142615 (1971)

[Expln of ethylene and oxygen is prevented in acetate monomer manufd by addn of a perhaloalkane. Thus, a mixed gas contg ethylene, O, ethanol and chloromethyltrifluoride is passed thru a reaction vessel packed with Pd/Al₂O₃ to safely give improved yields of the acetate over controls not contg chloromethyltrifluoride].

3) G.M. Severs, Jr, "Vinyl Acetate", GerP 2361098 (1974) & CA 81,170196 (1974)

[An increase of 15% yield is claimed by using methane in the prepn mixt to lower the expln limit of the substituents, thus allowing a higher concn of O which, in turn, increases the vinyl acetate space-time yield. Thus, a gas mixt of ethylene (44), methane (10), acetic acid (12), oxygen (8) and inert gases (CO₂+N₂+Ar+w vap) (26 vol %) is passed over a supported Pd-Au-alkali metal acetate solid bed catalyst at 70°/0 atm (gage) to give the monomer in a space-time yield higher by 15% over the same reaction involving ethylene (59), methane (1), acetic acid

Table 1
Properties of Explosive Compositions With and Without Addition of Ethylene/Vinyl Acetate Copolymer (EVA) Binder

	Comp A-3		Comp A-4		
	9% Grade A Wax	EVA/9% RDX	3% Grade A Wax	EVA/3% RDX	EVA/5% RDX
Composition analysis					
% binder	9	8.9	3	2	4.1
Impact sensitivity,					
50% Pt cm	30	30	17	19	27
Friction sensitivity, lb	646	589	324	389	490
Electrostatic sensitivity					
at 0.255 joules	10/10 NF	10/10 NF	10/10 NF	10/10 NF	10/10 NF
Pressed density, gm/cc	1.649	1.632	1.704	1.715	1.694
Compressive strength, psi	752	1.022	746	1.634	1.358
Modulus of elasticity, x 10 ⁶	0.18	0.03	0.06	.011	0.08
Abrasion test, % loss	5	0.60	11	1.8	0.66
Small scale cook-off	mild	mild	—	—	—

(12), oxygen (7) and inert gases (26 vol %)]
 4) H. Hijikata, "Sulfur-Free Match Ignition Composition", JapP 7509844 (1975) & CA **85**, 48931 (1976) [Good ignitability and high moisture resistance are claimed for match ign compns made using vinyl acetate. Thus, an aq glue soln (560g of a 40% soln) is heated to 80°, agitated for 40 secs, mixed with K chlorate (7400g), strongly agitated for 10 mins and mixed with 2ℓ of warm w. To this soln is added at 50°, shellac (100), rosin (100), powdered wood pulp (200), glass powder (3800), Ti dioxide (400), diatomite (500), Al hydroxide (200) and vinyl acetate (100g) to obtain the claimed ign compn]
 5) R. Reed, "Moldable Ethylene/Vinyl Acetate Copolymer", USP 4090894 (1978) & CA **89**, 148908 (1978) [Vinyl acetate copolymerized with ethylene is used as a desensitizer and binder for moldable expl compns of cyclic nitramines such as RDX. From 82 to 98 wt % of binder is used, and various ratios of ethylene to vinyl acetate moieties in the resin are utilized to modify molding and extrusion properties. Prepn of typical compns consists of dissolving the copolymer in benz and addition with stirring to an RDX/w slurry, which is stirred until mixt is complete, followed by filtration and drying. Table 1 presents properties of sample compns with and without the ethylene/vinyl acetate copolymer (EVA). The inventor also states that the EVA, unlike other polymeric binders, endothermically breaks down at high temps and acts as a heat sink for the expl content]

Vinyl Acetate Ozonide.

$\text{CH}_3 \cdot \text{CO}_2 \cdot \text{CH} \cdot \text{CH}_2 \text{O} - \text{O}^+ \text{O}^- \cdot \text{C}_4\text{H}_6\text{O}_5$; mw

134.10; OB to CO_2 -71.59%; cryst. Prepn is by ozonolysis of vinyl acetate. The ozonide is expl when dry

Refs: 1) Beil, not found 2) Kirk & Othmer, Vol **21**, 320 (1970) 3) Bretherick (1979), 485

Vinyl Acetylene (or Buten-3-yne).

$\text{CH}_2 : \text{CH} : \text{C} \equiv \text{CH}$, C_4H_4 ; mw 52.08; colorl gas or liq; bp 5.11°, d 0.7189g/cc at -10°, 0.6679g/cc at 30°; RI 1.4161. Sol in benz; not sol in w. CA Registry No [689-97-4]. Prepn is by reacting 2,4-dichloro-2-butene with K hydroxide in glycol at 170°. Product yield is 45%

Vinyl acetylene is considered an expl to be stored under an inert gas as a liq, or to be mixed with an inert gas at RT. It has violently expld when mixed with decahydronaphthalenes, 1,3-butadiene, and oxygen (forming the v expl peroxide) (Ref 9)

Strizhevskii and Moshkovich (Ref 5) report the following expl properties of vinyl acetylene-decalin mixts; by itself vinyl acetylene explds at 1.67 atm. Mixts of vinyl acetylene-decalin contg ≤ 62.5 wt % vinyl acetylene expld at 20° in either the liq or gaseous state; at < 60 wt % of vinyl acetylene the mixt is stable at 20°, but at 40° mixts contg ≥ 35 wt % of vinyl acetylene decomp. At 20 to 30 wt % of vinyl acetylene at 40°, expl decompn occurs in the gas phase, but liq state decompn is slow. They also report that ign of the mixts in the vap state requires less energy than in the liq state. According to Karapetyan et al (Ref 8), the expl temp of liq vinyl acetylene, normally 140-41°, can be raised 20-45° by addn of xylene, phenylmethane, benz, wood resin antioxidant or acetaldehyde. Conversely, divinylacetylene lowers the expl temp of vinyl acetylene in an air mixt. These investigators also report that acetaldehyde is the most effective safety additive; a 10% acetaldehyde/90% vinyl acetylene mixt raises the expl temp 20°, while 50% acetaldehyde/50% vinyl acetylene does not expl at all. Additionally they report that the expl temp of vinyl acetylene is unaffected by w

Vinyl acetylene can be polymerized by heating at 105° for approx six hrs to give a range of products from viscous liqs to resinous solids (Ref 2)

Liq vinyl acetylene is used as a raw material to make chloroprene rubber by addn of cold HCl, forming 2-chlorobutadiene-1,3 which is then appropriately polymerized to form the desired product (Refs 6 & 8)

Vinyl acetylene forms expl salts such as:

Mercury-Bis-Vinylethynyl.

$(\text{CH}_2 : \text{CH} : \text{C} \equiv \text{C})_2\text{Hg}$, $\text{C}_8\text{H}_6\text{Hg}$; mw 302.73; dark at 0°, becomes a yel solid at RT; mp 144-45°, 142.0-0.5° (separate values); v sol in chl. Prepn is by reacting vinyl acetylene with Hg oxide in acetic acid at RT. The salt explds when heated or struck

Silver Vinyl Acetylene. $\text{C}_4\text{H}_3\text{Ag}$; mw 158.94; leaflets. Prepn is by reacting vinyl acetylene with

Ag nitrate. Beil (Ref 1) terms this salt as being v expl; contact with one drop of ammonia causes a strong deton

Sodium Vinyl Acetylene. C_4H_3Na ; mw 122.11; a flesh-colored solid when freshly prepd. Prepn is by reacting Na amide with liq ammonia. The salt explds when brought in contact with a variety of org solvents and reagents

The polymerization product of either 1-iodobuten-(3)-in(1) or 2-iodo-1-vinyl acetylene, formed by reacting either of these compds with an aq acid soln, is a hard black, v expl solid of the general formula $(C_4H_3I)_x$

Refs: 1) Beil 1, 126; 1032 ff 2) C.E. Shildknecht, "Vinyl and Polymers . . .", J. Wiley, NY (1952), 704 3) G.F. Hennion et al, "Monovinyl Acetylene", OrgSynColl, Vol 4 (1963), 684 4) T.F. Rutledge, "Acetylenic Compounds", Reinhold, NY (1968), 28 5) I.I. Strizhevskii & F.B. Moshkovich, "Explosive Properties of Vinylacetylene . . .", PromSin-Kauch, Nauch-TekhSb, No 12, 4-5 (1971) & CA 78, 98670 (1973) 6) CondChemDict (1977), 916 7) ChemRubberHndbk (1978), C-232 8) N.G. Karapetyan et al, "Effect of Different Components on the Explosion Temperature of Liquid Vinylacetylene in a Closed System", PromStArm, (9), 36-38 (1977) & CA 88, 8178 (1978) 9) Bretherick (1979), 462-63

Vinyl Alcohol-Acetate Resin (VAAR). According to the US Military specification (Ref 6) the resin consists of a mixt of approx 28% solids and 72% solvent. The solids are approx 18% hydroxyl content by wt calcd as vinyl alcohol and 82% as vinyl acetate. The solvent is tech grade methyl acetate (82% pure). The spec requirements are: *Color* - Equivalent to No 300 Pt Co std when a sample aliquot soln is compared visually using 100ml tall-form Nessler tubes against a white background

Polyvinyl alcohol content - 16 to 19 wt % calcd on a dry basis using a turbidimetric procedure consisting of sample aliquot addn to a series of std w-acet solns (differing in the proportions of w to acet) until a clear soln is formed (not turbid) indicating the appropriate wt % of the dry resin

Total solids - 26 to 29 wt % detd gravimetrically after evapn of solvent at 135° for over one hour. The resin mixt is obtainable from approved sources such as Union Carbide Plastic Co, NY

(designated MA-28-18)

According to the current (circa 1980) bulletin released by the Union Carbide Corp (Ref 8) tension tests of VAAR bonded metal samples indicate a shear strength of 6000 lbs/sq inch. The pamphlet also states that the resin exhibits a wide range of NC compatibility. Other VAAR solns supplied by this vendor include one using toluene as the solvent with 24.5% solids (designated as T-24-9), and another with butyl acetate as solvent contg 28% solids (designated BA-28-18)

The resin (MA-28-18) is used primarily as a binder for pyrots. Werbel and Key (Ref 2) detd the effect of adding 1 p of VAAR on the burning rate and sensitivity of some Ba chromate/B delay compns. They report that for 90/10 Ba chromate/B, the addn of 1 p of VAAR decreased the burning rate from 0.720 to 0.902 sec/inch and decreased both impact sensy (PA appar-12" to 24") and friction sensy ("complete burning" to "no action"). Similarly, the Ba chromate/B-95/5 compn, upon the addn of 1 p of VAAR decreased its burning rate from 1.36 sec/inch to 1.955sec/inch while its friction sensy decreased from "complete burning" to "no action". The authors conclude that the effect of the VAAR on the burning properties of the compn is minimal, while the increase in mechanical strength is beneficial. Carrazza and Kaye (Ref 3) found that the ignition and decompn temps of pyrot oxidants and compns are lowered by VAAR. Also found was that the illuminance and burning rate characteristics of typical yellow, red and green consolidated systems contg VAAR did not show any significant changes as a result of a one-year surveillance period at both ambient and high (167°F) temps. They concluded that VAAR can be used as an alternate for Laminac resin as a binder in consolidated pyrot compns

According to Ellern (Ref 4) VAAR has been used in colored smokes deployed by means of aircraft launched rockets. Incorporation of VAAR into the various smoke compns allowed for use of a 45000 lb/sq inch loading pressure (instead of 9000 lb/sq inch) with a substantial increase in cohesive strength, resulting in a burning rate increase of 12% with a volume decrease of 20%. Manno (Ref 5) reports that compns contg K chlorate, sugar, VAAR and the white dyes 2-chloroanthraquinone and 1,4,5,8-tetrachloroanthraquinone were found to produce

good quality grey-white smoke clouds. Beardell et al (Ref 7) investigated the thermodynamic role of VAAR in the SI-143 delay compn: Zr (58), MoO₃ (25), Cr₂O₃ (16) and VAAR (1%).

Added to alter the cohesion characteristics of the pressed blend, the resin actually promotes the ign of the fuel-oxidant system at 550°. The authors conclude that the VAAR appears to aid in the ign of the Zr/MoO₃ system by providing heat from the exothermic reaction between C (pyrolysis residue of VAAR) and MoO₃. This reaction, they state, proceeds at a high rate at about 480° and is close to the minimum ign temp of the Zr/MoO (the second stage of the ign process) reaction at about 490°

Refs: 1) Beil, not found 2) B. Werbel & L. Key, "The Use of Vinyl Alcohol Acetate Resin in Barium Chromate/Boron Compositions", PATR 3250 (1965) 3) J.A. Carrazza, Jr & S.M. Kaye, "Storage Stability of Pyrotechnic Compositions Containing Vinyl Alcohol Acetate Resin", PATR 3357 (1966) 4) Ellern (1968), 413 5) R. Manno, "Use of Organic Dyes in White Smoke Formulations", PATR 1839 (1968) 6) Anon, "Vinyl Alcohol-Acetate Resin Solution (VAAR) (For Use in Ammunition)", MIL-V-50433 (MU) (1969) 7) A.J. Beardell et al, "... Thermoanalytic Study of the SI-143 Delay Composition", PATR 4246 (1971) 8) Anon, "Bakelite Vinyl Alcohol-Acetate Resin Solutions", Plastics Div, Union Carbide Corp, NY (1980)

Vinylamine (Aminoethene, Aminoethylene, Ethyleneimine or Ethenylamine). CH₂:CH.NH₂, C₂H₅N; mw 43.08; colorl liq; ammoniacal odor; bp 55–56° at 765mm; d 0.8321g/cc at 24°; RI 1.3895. Infinitely sol in ethanol and w; sol in ethanol. Prepn is by carefully washing the ethylenimino ester of N-vinylcarbamino acid (CH₂:CHNHCO₂H.HN₂.CH₂.CH₂) with a small amt of w at 0° (de-esterification). According to Seher (Ref 2) attempted reaction with isoprene led to a violent expln. Highly toxic; TLV is 0.5ppm (1mg/M³) for any entry route

Refs: 1) Beil 4, 203 2) A. Seher, Ann 575, 153–61 (1952) & CA 47, 3800 (1953) 3) E.R. Plunkett, "Handbook of Industrial Toxicology", Chem Publ Co, NY (1976), 179

Vinyl Aniline. See in Vol 1, A257-L to R under "Aminostyrenes and Derivatives"

Vinyl Azide. CH₂:CHN₃, C₂H₃N₃; mw. 69.08; liq; bp 30°. Sol in methanol. Prepn is by reacting β-chloroethyl azide with a hot aq soln of K hydroxide and ethylene glycol with refluxing for a few minutes. The product is distld off as it is formed from the reaction mixt and freed of w by freezing the w, followed by decantation of the product. The azide is considered to be a dangerous and highly sensitive material which has detonated when mishandled. It can be polymerized to a white flaky infusible solid by either solution or bulk polymerization in 5% yield. The polymer, according to Wiley and Moffat (Ref 2), burns furiously when held to a flame and decomps with great violence when touched with a hot wire

Refs: 1) Beil, not found 2) R.H. Wiley & J. Moffat, "Preparation and Polymerization of Vinyl Azide", JOC 22, 995 (1957) & CA 52, 2801 (1958) 3) Bretherick (1979), 365

Vinylbenzene and Derivatives. See in Vol 8, N143-L to N144-R under "Dinitro polystyrene"; P349-R to P350-L under "Polystyrene" and in Vol 9 under "Styrene and Derivatives", plus the following *Addnl Refs*: 1) J.C. Balaceanu & G. Clement, "Oxygenated Rocket Fuel", FrP 1313058 (1962) & CA 59, 11182 (1963)

[Suggested is the use of oxygenated org polymers (called by the inventors polyperoxide(s) or PPO(s)) such as polyvinylstyrene PPO to supply part of the oxygen required for combstn, thus minimizing the dead wt associated with the use of solid perchlorates or liq hydrogen peroxide as fuel oxidizers. For example, oxygen is bubbled into styrene at 35 to 50° in the presence of 0.02 mole of azodiisobutyronitrile/l of styrene. After 24 hrs, the absorption of oxygen corresponds to the formation of 20% of the theoretical polystyrene PPO. The product is recovered either by pptn by the addn of cold methanol and then dried, or by removal of the unreacted styrene by vac distln. Other compds which the inventors claim can be so treated to form PPO(s) are acrylonitrile, vinyl acetate, and two forms of dimethylbutadiene] 2) K.E. Coulter et al,

"Styrene and Related Monomers", "Vinyl and Diene Monomers—Part 2", E.C. Leonard, Ed, J. Wiley, NY (1972), 517–21 [Exhibited is the styrene polyperoxide monomer formula (—CHCH₂.O.O—)]



, C₆ H₈ O₂; monomer mw 136.16]

Vinyl Carbinol. See in Vol 1, A135-R to A136-L under "Allyl Alcohol . . ."

Vinyl Chloride. See in Vol 3, C255-R to C256-L under "Chloroethylene and Derivatives", and Vol 8, P343-R to P345 under "Polymerization, Violent". The polymer is to be found in Vol 8, P354-R to P356-L under "Polyvinyl Chloride". *Addnl Refs* on both the monomer (VCM) and the polymer (PVC) are presented next:

Note: Current (circa 1981) computer search lists the CA Registry No of VCM as [75-01-4]

Analysis: E. Sistig, "Recent Methods and Trends of Automatic Analyzers in the Chemical Industry . . . Vinyl Chloride . . . ppm Range", Proc 5th IntCongrChemEngrgChemEquipDes-Autom, Prague (1975) & CA 86, 8217 (1977) [The instruments with the ability to determine 0 to 20 ppm of VCM with an accuracy $\geq \pm 2$ ppm include flame ionization detectors (FID), gas chromatographs using FID, dispersive IR analyzers with spectrometer cells, analyzers based on electrical conduction with upstream combstn chambers, and analyzers with Cl sensitive test paper]

Explosions: 1) Bretherick (1979), 360 [Reported are the factors which can cause and control stored VCM explns; viz, exposure of the monomers to atmospheric oxygen causes the formation of unstable polyperoxides which can initiate an expln. This explphore can be destroyed by the use of an aq 20–30% Na hydroxide soln] 2) M. Pazdry, "Mexico: Explosion of Storage Tanks Containing Vinyl Chloride", OchPrzeciwozarowaPrzemChem (1-2), 48–50 (1979) & CA 92, 63995 (1980) [The expln of storage tanks contg VCM in Puebla, Mex on June 11, 1977 is reported]

Handling and Storage: 1) P.G. Shelley & E.J. Sills, "Monomer [. . . Vinyl Chloride] Storage

and Protection", ChemEngrgProg 65 (4), 29–35 (1969) & CA 70, 115580 (1969) [Recommendations include: a) minimization of spills and leaks, b) elimination of ign sources, c) provision for a drained and deluged dike area, and d) elimination of system contamination with air or an oxidizing chemical] 2) D.L. Dowell, "Handling Vinyl Chloride Emergencies", LossPrev 5, 29–31 (1971) & CA 76, 76079 (1972) [Conclusions derived from modeling techniques indicate that the burning of VCM premixed with oxygen can produce a phosgene concn of 20–40 ppm, and in tank car loads (200000 lbs) would produce a ground level HCl concn of 5 ppm to a distance of 10000 ft]

Production: 1) W.W. Woods & D'Arcy A. Shock, "Encapsulated Propellant Preparation from Fluorinated Monomers by Using Radiation", USP 3441455 (1969) & CA 71, 14738 (1969)

[Claimed is a means of polymerization of proplnt binders using γ -radiation. Thus, a cast proplnt contg powdered Al (16), AP (64), an equimolar mixt of VCM and low mw polystyrene (2 wt %) is prepd by stirring the VCM and polystyrene in a pressure vessel until dispersion occurs and the viscosity reaches 1000cp, adding fuel and oxidizer and then forcing the mixt into a casing where it is irradiated for 12 hrs at 10⁵ rep/hr at 70°F and 500 lbs pressure] 2) Anon, "Method of and Apparatus for Processing Polyvinyl Chloride Mixtures", BritP 1517330 (1974) & CA 90, 105139 (1979) [Claimed is the processing of vinyl chloride in a heated mixt without risk of expln of residual VCM by heating the mixt under reduced pressure to 110–30°, and simultaneously sucking fresh air at 250–500 Torr thru the rotating mixt at a vol/minute of 3–5 times the free vol of air in the mixer. The patent states that the lower expl limit of the residual monomer-air mixt is not reached using the described technique]

3) Anon, "Vinyl Chloride . . .", C&EN 58 (27), 9 (1980) [The current (circa 1980) popular means of comml prodn is reported as the dehydrochlorination of ethylene dichloride made from ethylene and Cl] *Pyrolysis:* I.K. Varma & K.K. Sharma, "Thermal Degradation of Poly (Vinyl Chloride) in the Presence of Additives—Part I", AngewMakromol-Chem 71, 157–66 (1978) & CA 89, 164244 (1978) [The rate of dehydrochlorination of PVC at temps above 200° is reduced in the

presence of maleic anhydride, p-benzoquinone and 9,10-anthraquinone. The authors conclude that the effect of maleic anhydride is due to the disruption of polyene sequence by a Diels-Alder reaction, and that the stabilization effect produced by the quinones can be attributed to radical addn reactions. Also reported is the information that at $< 200^{\circ}$ the dehydrochlorination rate increases on addn of maleic anhydride]

Toxicity: This is an addendum to information entered under "Vinyl Compound Toxicity".

1) Anon, "Recommended Standard for Occupational Exposure to Vinyl Chloride", **PB-246691**, NIOSH, Rockville (1975) [The report recommends, in part, that "... Despite the fact that animal experiments have shown no liver tumors at atmospheric concentrations of 50 ppm ... no woman who is pregnant or who expects to become pregnant should be employed directly in vinyl chloride monomer operations ...; the concept of an allowable working level is rejected." Where there are measurable concns of VCM an air-supplied respirator should be worn (chemical cartridge respirators do not afford adequate protection against VCM vapors)]

1a) J. Michael, "Toxicity of Pyrolysis and Combustion Products of Poly (Vinyl Chloride); FireMater 1 (2), 57-62 (1976) & **CA 86**, 51210 (1977) [The toxic effect of PVC combstn products on the human organism was evaluated and the Toxic Threshold Level is reported as 0.3g of PVC products/M³ of air]

2) M. Bert et al, "Reduction of Smoke Generation in Poly (Vinyl Chloride) Combustion", **FireRes (4-5)**, 301-11 (1978) & **CA 90**, 72796 (1979) [The authors report that the most efficient (toxic) smoke suppressors for PVC are those which show catalytic activity in oxidation reactions, such as Cu, Fe, or V compds. These suppressors cause incandescence and complete combstn of the solid residue without excessive smoke prodn. They conclude that their efficiency is not very dependent on the anion bound to the metal, but may depend on the temp]

3) E.A. Harrison, "Toxicity of Vinyl Chloride", **PB-80-807662**, NTIS (1980) [Abstracts of 164 reports on the subject from 1969 to March of 1980 are presented]

Uses: 1) K.E. Rumbel, "Poly (Vinyl Chloride) Plastisol Propellants", **AdvanChemSer 88**, 36-66 (1969) & **CA 71**, 51803 (1969) [The author sum-

marizes the use of PVC plastisol proplnts in control motors, sounding rockets and tactical weapons and reviews their characteristics and manuf circa 1969. These proplnts consist of finely powdered solid oxidizer and (sometimes) powdered metal uniformly dispersed in cured PVC plastisol. Information is given on compn, uncured proplnt flow, curing time, variation of phys properties with temps of cure and use, combustion products, safety characteristics, and manufg techniques. Effects of oxidizer content (NH₄ClO₄ or KClO₄) on specific impulse, flame temp, d, and burning rate are shown. Burning rate is correlated with oxidizer particle size. Wide variation of burning rate by use of additives and fine metal wires is demonstrated. The effects of Al and Mg on specific impulse and burning rate are covered]

2) R.S. Scheffee, "Gas-Generating Compositions for Safety Device Inflation", **GerP 2222506** (1972) & **CA 78**, 45850 (1973) [The inventor claims impact-sensitive gas-generating compns especially useful for filling bags for protection against injury during accidents in automobiles, etc, which contain plasticized PVC as a substrate, carbon black, halogen-free oxidants, stabilizers and (optionally) catalysts. Thus, a compn contg PVC (7.114), dioctyladipate (10.42), gas black (0.050), K nitrate (11.510), K perchlorate (70.705) and stabilizer (0.200%) had a combstn rate of 15.2 and 68.7 mm/sec and 35 and 350 kg/sq cm, resp; a self-ign temp of 360°; and an impact sensy of >300 kg-cm]

3) H.J. Zilcosky, "Rockets Providing Colored Illumination", **FrP 2154213** (1973) & **CA 79**, 116709 (1973) [The intensity and color integrity of colored smoke compns are improved thru the use of plasticized PVC binders. Thus, an equal amt of PVC resin and dioctyl phthalate are mixed. To 20 p by wt of this plastisol, 36 p of Sr nitrate and 25 p Mg powder are added and mixed for 15 minutes. The mixt is then cast in a 100 x 25mm mold and placed in an oven at 170° for 1 hr. The inventor reports that after ign a red colored smoke lasting 60 secs with a chromatic value of 0.65 and a cp of 15900 was observed]

4) J.M. Smith & H.J. Zilcosky, "Smoke Generating Cord", **FrP 2154214** (1973) & **CA 79**, 116710 (1973) [Claimed is a granulated smoke-producing compn which is prepd from PVC (15), dioctyl phthalate (15), AP (27), Zn oxide (35) and amm chloride (8 p by wt).

The mixt is cast or injected around a type C Ignitacord fuse and wrapped with polyethylene and a rayon thread] 5) H.J. Zilcosky, "Caseless Smoke Grenade Including a Poly (Vinyl Chloride) Binder", USP 3724382 (1973) & CA 79, 21215 (1973) [Claimed is a flameless cast flexible main charge consisting of PVC, a plasticizer, a perchlorate oxidizer and Zn oxide plus optional additives which has a combstn temp of $<1000^{\circ}$. Thus a white smoke compn is prepd by mixing equal parts of PVC and dioctyl phthalate, adding Zn oxide (35) and amm chloride (8), blending and then adding AP (27%), blending for another 15 minutes, pouring into a 1-inch diam cardboard tube, curing the cast compn at 300°F for 2 hrs, cooling and removing the mold. The inventor reports that the solid charge thus prepd burns in cigarette fashion at 4 inches/minute after ign at one end] 6) N.A. Boikov et al, "Inhibition in Construction of Explosion-Proof Electrical Equipment", 1st 1970 MaterSoveshch-MekhInginilirovaniyaTsepnykhGazovReakts, 236-43 (1971) & CA 80, 122932 (1974) [Reported is successful experimentation on expln suppression using PVC powder placed in the air-entry slits of expln and fireproof casings of electrical equipment] 7) W.L. Greever, "Case Bonding Composite for Double Base Propellants", USP 3960088 (1976) & CA, not found [Claimed is a two-layer composite for case bonding double base proplnts. The layer next to the case and internal components is comprised of an optional VCM-V acetate copolymer formulation. Claimed advantages of this system include adequate adhesion, good mechanical stress properties and protection of substrates from absorption of energetic plasticizers (such as NG) used in the proplnt per se] 8) R. Maire, "Molded Propellants", FrP 1605299 (1974) & CA 84, 76542 (1976) [Claimed are molded plastisol rocket motor proplnts which are easily prepd, safe to handle, and are not brittle. Thus, a mixt of AP (74.75), DOP (13.25), plastisol grade VCM (11.75) and tribasic Pb phosphate (0.25%) is prepd and molded to give grains having good ballistic properties which are affected by temp variations only 25-35% as much as conventional proplnts] 9) C.M. Lownds, "Incendiary Compositions", SAfricanP 7401060 (1975) & CA 84, 152905 (1976) [The inventor suggests the use of finely

powdered PVC as a fuel in a compn to form plastic incendiary igniter cords and fuses which, he claims, are relatively safe to manuf in a continuous manner by extrusion as rods on a central flexible fabric or metal support, heating to set the compn, and cooling with air or w. Thus, a suspension of PVC (4) in DNT (12.8) and mononitrotoluene (3.2) is mixed with 150-micron K perchlorate (20) and 50-micron ferromanganese (60%); the mixt is extruded on a 2-mm diam rod on a flexible cotton support, heated and then cooled. The burning rate of the rod is 260 secs/minute. Or, the mixt can be incorporated conventionally as the core of an incendiary fuse having a mean burning time reported, as the avg of 75 tests, of 271.2 secs/minute with a std dev of 1.2 to 4.2 secs/minute] 10) S. Krishnan & T.K. Bose, "Theoretical Performance of Polyvinyl Chloride Plastisol Propellants: A Comparative Study", JSpaceCraftRockets 12 (3), 187-98 (1975) & CA 84, 33343 (1976) [A series of theoretically derived monographs for PVC binder plastisol proplnts is presented indicating the variation of specific impulse and d specific impulse, theoretical specific impulse, max specific impulse and max d specific impulse with a variation in compn and compn percentages]

Vinyl Cyanide. See in Vol 1, A97-R to A98-L under "Acrylonitrile", in Vol 8, P343-L to P345 under "Polymerization, Violent", and in the following *Addnl Refs*: 1) M.L. Peterson, "Gelled Aqueous Acidic Composition for Explosives", USP 3507720 (1970) & CA 73, 5610 (1970) [Expl gels of good homogeneity, w resistance and excellent stability are claimed in this invention. For example, 75% nitric acid (85.2), mineral oil (11.1), starch (2.5) and polyvinyl cyanide (1.2%) are mixed for 10 to 20 minutes with $\text{N,N}'$ -dimethylolamine ketone (0.005%) to prepare a gel which was detond in a 20-lb ctge using 1 lb of TNT as the booster. The deton vel is reported as 5000m/sec] 2) Bretherick (1979), 423-24 [Reported are extremely violent to expl reactions when vinyl cyanide is in contact with acids, bases, bromine, polymerization initiators (such as azoisobutyronitrile, dibenzoyl peroxide or di-tert-butyl peroxide), Ag nitrate and tetrahydrocarbazole (when cyanoethylation is initiated by benzyltrimethylammonium hydroxide)]

Vinyldiazomethane. $\text{H}_2\text{C}:\text{CHCHN}_2$, $\text{C}_3\text{H}_4\text{N}_2$; mw 68.09; dk red, UV sensitive, liq. Sol in pentane. CA Registry no [2032-04-4]. Prepn is by reaction of a soln of allylnitrosocarbamate in pentane added dropwise to a methanolic soln of Na methoxide in the dark at 0° . After washing the product twice with a cold aq Na hydroxide (5%) soln, it is dried over anhydr K hydroxide and stored at 0° in the dark. Yield is 82–85%. According to Ref 2 this vinyl compd is expl
Refs: 1) Beil, not found 2) R.G. Salomon et al, "Vinylcyclopropanation of Olefins With Vinyldiazomethane", *JOrgChem* **40** (6), 756–60 (1975) & *CA* **84**, 73700 (1976) 3) Bretherick (1979), 428

Vinyl Ethylene. See in Vol 2, B365-R to B366-R under "Butadiene and Derivatives"; Vol 3, C464-L to C474-L under "Composite Propellants"; Vol 8, P327-L to P331-L under "Polybutadiene and its Use as a Binder With Energetic Materials", also under "Polymerizations, Violent" in the table on P344, and under "Propellants, Solid", P412-L to P415-Table 17; plus the following *Addnl Refs:* Note—The CA Registry No for Vinyl Ethylene is [106-99-0]

Analysis: M. Bollini et al, "Determination of Free Monomers in Aqueous Emulsions of Synthetic Polymers and Copolymers", *Textilia* **51** (3), 25–28 (1975) & *CA* **83**, 60039 (1975)
 [In order to determine the type and amount of free monomer present in vinyl polymer latexes (so as to ascertain the toxic and expl hazards posed by their presence) the authors report the use of a gas chromatographic technique to successfully identify and measure the amount of vinyl ethylene]

Energetic Parameters: 1) N. Masao et al, "Fundamental Studies on Combustion of Solid Propellants II. Burning Velocities of Multi-Component Fuel", *KogyoKayakuKyokaishi* **27** (5), 295–301 (1966) & *CA* **66**, 67463 (1967)
 [The results of these studies indicate that the burning rate of a stoichiometric mixt of ethylene-air is reduced by 27% when 20% of the ethylene is replaced by vinyl ethylene. Also, that the burning rate of a stoichiometric mixt of vinyl ethylene-air is changed slightly even if 40% of the vinyl ethylene is replaced by ethylene. In addn, the authors report that the effect of

gaseous ammonia on the burning rate of the former mixt is larger than on the burning rate of the latter mixt] 2) R.L. Johnson & B. Siegel, "Chemistry of Electrical Wire Explosions in Hydrocarbons", *JElectrochemSoc* **115** (1), 24–28 (1968) & *CA* **68**, 38951 (1968) [Pyrolysis of vinyl ethylene in a stainless steel closed bomb using an exploding Pt wire as the means of initiation is reported. The monomer was pressurized at 400 to 450mm at RT. The energy imparted to the specimen was 466 joules, resulting in 3.9% pyrolysis of the sample with volatile products (abundance ratio) reported as C_2H_2 (100), CH_4 (6.6), C_3H_4 (2.8) and C_6H_6 (1.1)] 3) F. Maslonlsa, "Determination of the Laminar Combustion Velocity of Gas Mixtures from Values of Explosion Times Found in Determination of Explosion Characteristics", *Petrochemia* **18** (3), 99–103 (1978) & *CA* **90**, 57473 (1979)
 [Good agreement between exptl and calcd data is reported for vinyl ethylene using the equation $\gamma \cdot T_v = a$ constant, where γ is the laminar combustion vel and T_v is the expln time (or time to expln?)]

Manufacture: 1) D.H. Richards, "The Polymerization and Copolymerization of Butadiene", *ChemSocRev* **6** (2), 235–60 (1977) & *CA* **87**, 184973 (1977) [Reported are circa 1977 theory, techniques and kinetic measurements of vinyl ethylene polymerization. Covered are emulsion, anionic, alkali-metal initiation, alkyl Li, alfin catalyst and transition metal catalyst polymerization techniques] 2) T. Hutson, "Oxidative Dehydrogenation Effluent Control", *USP* 4069272 (1978) & *CA* **89**, 25799 (1978) [The inventor suggests a means to control accidental ign in the oxidative dehydrogenation of butene to vinyl ethylene. The oxygen concn in the gas phase of the reactor effluent separator is kept below the combstn limit by recycling part of the butadiene concn stream] 3) A. Lindner et al, "Recovery of 1,3-Butadiene from C_4 -Hydrocarbon Mixture", *GerP* 2823983 (1979) & *CA* **99**, 111502 (1980)
 [The reported technique consists of a distln method designed for the recovery of vinyl ethylene from a C_4 hydrocarbon fraction obtd during ethylene mfg. The C_4 fraction is subjected to continuous extractive distlns thru a series of columns in mixt with a selective solvent for vinyl ethylene to give a final product of high vinyl ethylene concn]

Safety: 1) D.A. Scott, "Hazards with Butadiene and its Peroxides", *EngrgNews* **18**, 404 (1940) [Reported is a summary of the expl hazards associated with the handling of vinyl ethylene including heating under pressure and the formation of expl peroxides via contact with air or oxygen. The recommended technique for safely destroying these peroxides is by treatment with 47% aq Na hydroxide] 2) D.H. Kubicek, "Use of a Nickel Complex to Prevent Explosions When Storing Dienes in the Presence of Oxygen", *USP* 3557225 (1971) & *CA* **74**, 143988 (1971) [The inventor claims that the use of 0.1 to 3% of a Ni complex (for example, bis (triphenyl phosphine) dichloronickel) mixed with a diene, such as vinyl ethylene, will prevent the formation of detonable peroxides upon the storage of the diene. Further, the complex can be sep'd from the diene by washing or distln] 3) R.H. Freeman & M.P. McCready, "Butadiene Explosion at Texas City", *LossPrev* **5**, 61-66 (1971) & *CA* **76**, 87655 (1972) [The authors report the scenario of the Texas City disaster as follows: "During the 8 hr and 23 min preceeding the explosion, the Texas City butadiene refining column was operated in a standby mode of an unsteady-state, batch distn. of a relatively pure butadiene fraction. This mode of operation brought about abnormal, liq.-phase concn. profiles within the column. The vinyl-acetylene concn. reached 40-59 mole %. The liq. in the base of the column fell to a level above that required to maintain flow to the reboiler, but below that required to maintain natural circulation through the tubes. At this point, a reaction occurred in the reboiler tubes; 5 of the tubes yielded to an internal pressure and burst; and the reaction propagated"] 4) R. Keister et al, "Butadiene Explosion at Texas City", *LossPrev* **5**, 67-75 (1971) & *CA* **76**, 87656 (1972) [The authors further delineate the anatomy of the Texas City disaster and map precautionary procedures to prevent reoccurrence. They found that the max temp for butadiene refining systems should be $< 105^{\circ}$ to prevent explns. Since vinyl acetylene-1,3-butadiene mixts are thermally unstable, normally generating exotherms and explns, any higher temp insures such instability. Also, if Na nitrite is converted to Na nitrate, this too makes the mixts less stable. If the concn of vinyl acetylene is ≤ 40 mole %, it does not support a vapor-phase

deflagration at 65 psia. However, they report that the temp and pressure developed from a vapor-phase deflagration is sufficient to initiate an expl decompn in the liq phase. As for addnl precautions, the authors recommend that in butadiene refining, total reflux should be avoided. Additionally, a residual flow should be maintained for as long as there is heat on the system reboiler. For polymer and peroxide control the authors recommend that 10 ppm (based on the reflux flow) of nitrosophenylhydroxylamine be used in the reflux loop]

Uses: 1) E.J. DeLorenzo & R.V. Wright, "Reaction Products of Decaborane and Conjugated Diolefine", *USP* 3301907 (1967) & *CA* **66**, 97089 (1967) [The inventors claim that treatment of $B_{10}H_{14}$ with a conjugated diolefin such as 1,3-butadiene in the presence of dialkyl ethers forms products suitable for use in solid proplnts or high energy liq fuel mixts. Thus, 1,3-butadiene (75), $B_{10}H_{14}$ (75), and dimethyl ketone (200 millimoles) are heated to 165° for 4 hrs in a 150-ml high-pressure reactor to give a product contg 56.6% B, which is thermoplastic and sol in benz and ethylene dichloride. The inventors suggest that the addn of H-reduced Cu powder to the reaction mixt as a polymerization inhibitor results in a viscous liq contg 61.1% B which is usable in liq fuels for gas-turbine engines] 2) A.D. Hewitt, "Heating of Materials by Combustion of a Fuel Gas", *BritP* 1298461 (1972) & *CA* **78**, 100214 (1973) [The inventor suggests the use of 1,3-butadiene instead of acetylene in a welding torch. He claims a flame temp of 2910° , and steel welds of comparable strength and properties as those produced by an oxy-acetylene torch. For example, a welding torch fed with 2.5 cubic ft/hr of gas contg 99.3% 1,3-butadiene and 8 cubic ft of oxygen/hr welds 1/8" steel plates 10% slower than an oxyacetylene flame, but the inventor claims that butadiene is more convenient to transport than acetylene] 3) M.G. Baldwin & S.F. Reed, "Vinyl Ferrocene-Butadiene Copolymers", *USP* 3753812 (1973) & *CA*, not found [Suggested is the use of the copolymers as binder for solid proplnt compns and as a means of increasing the burning rate of solid proplnts. For example, butadiene/vinyl ferrocene copolymer binder (10.0), isodecyl pelargonate plasticizer (10.0), Al powder (10.0) and AP (70 wt %) are mixed to form a proplnt

compn. The inventors claim that this proplnt formulation has a 20% higher burning rate as compared to a *standard* proplnt compn contg only polybutadiene] 4) C. McCulloch et al, "Propellant and Consumable Cartridge", USP-Applic 473456 (1974) & CA 85, 179850 (1976) [Suggested is the use of hydroxyl or carboxyl terminated polybutadiene binder to produce a high density proplnt suitable for making a consumable ctge with stable ballistics and dimensional characteristics, w-resistance, and with an increased muzzle vel capability over the standard proplnt. The suggested component ranges are binder (10-30), curing agent (≤ 5 to 6), oxidizer (70-90), burning rate control additives (≤ 12), and stabilizers such as S or Cu sulfate (0.2%)] 5) G.L. Duchean & G. Perrault, "Binder Composition for Powdered Propellants", BelgP 869619 (1978) & CA 91, 7172 (1979) [The inventors suggest the use of hydroxyl-terminated polybutadiene as a binder for castable composite proplnts] 6) M. Sichel & J.C. Foster, "The Ground Impulse Generated by a Plane Fuel-Air Explosion with Side Relief", ActaAstronaut 6 (3-4), 243-56 (1979) & CA 91, 125540 (1979) [Reported are exptl values of the overpressure and positive impulse behind a plane (air blast) wave obt'd using a plastic bag, 4'x3'x20', filled with a stoichiometric mixt of 1,3-butadiene and air. The deton was initiated using an expl initiator located at one end of the bag consisting of a disc-shaped 85g PETN based DuPont "detasheet" expl]

Vinylethyl Ether. See in Vol 6, E339-R and under "Visol" in this Vol

Vinyl Ferrocene [Vinyl-dicyclopentadienyl-iron or Cyclopentadienyl-(vinylcyclopentadienyl)-iron]. $\text{CH}_2:\text{CH.C}_5\text{H}_4.\text{Fe.C}_5\text{H}_5, \text{C}_{12}\text{H}_{12}\text{Fe}$; mw 212.09; red solid with a strong camphor-like odor; mp 48-49°; bp 80-85° at 0.2mm. V sol in eth, methanol and petr eth. Prepn is by pyrolysis of cyclopentadienyl-(α -hydroxyethylcyclopentadienyl)-iron using alumina at 200° under reduced pressure. The process used for the pyrolysis is distln. The crude desired product remains on the distln column's alumina packing. The 21% yield is removed from the packing when

cool with eth, and the eth is then distld off under reduced pressure. Vinyl ferrocene can be polymerized and also act as a copolymer with a monomer such as butadiene. This property is the basis for several inventions by Burnett (Refs 3 & 4) in the area of proplnt binder formulation. Additionally, Burnett claims control of the burning rate by means of the polymer induced Fe content of the proplnt, ie, the burning rate increases with the dispersed Fe content] Refs: 1) Beil, not found 2) F.S. Arimoto & A.C. Haven, Jr, "Derivatives of Dicyclopentadienyliron", JACS 77, 6295-97 (1955) & CA 50, 8612 (1956) 3) J.D. Burnett, "Vinyl Ferrocene Butadiene Copolymer Burning Rate Catalyst", USP 3770287 (1973) & CA 80, 49970 (1974) 4) Ibid, "Propellant Composition Containing Polymers of Vinyl Ferrocene", USP 3813307 (1974) & CA 81, 9362 (1974)

Vinyl Fluoride. See in Vol 6, F140-L under "Fluoroethylene"

Vinyl-2,2,2-Fluorodinitroethyl Ether Polymer.
Monomer

$\text{FC}(\text{NO}_2)_2.\text{CH}_2.\text{O.CH:CH}_2, \text{C}_4\text{H}_5\text{FN}_2\text{O}_5$; mw 180.11; OB to CO_2 -48.86%; colorl oil; bp 61-62° at 13mm. Prepn is by reacting a soln of 45g of 2,2,2-fluorodinitroethanol in 80g of inhibited vinyl acetate with 0.6g of Hg acetate and 0.045ml of concd sulfuric acid at 0°. Excess vinyl acetate is then distld off, the residual oily product washed with 100ml of 0.1N Na hydroxide, dried over Mg sulfate, and then fractionally distld at 10mm to give a 51% yield

Polymer

$[\text{FC}(\text{NO}_2)_2.\text{CH}_2.\text{O.CH:CH}_2]_{8.33}$; mw 1500; visc brn oil. Prepn is by heating a soln of 5g of the monomer with 0.125g of azobis (isobutyronitrile) under N_2 for 24 hrs at 85°. The unreacted material is then vac distld off, leaving a 4g yield. Ref 2 states that this product is a highly energetic polymer which can be used as an ingredient in PBX and proplnt compns Refs: 1) Beil, not found 2) H.G. Adolph, "2,2-Dinitroalkyl Vinyl Ethers and Polymers Thereof", USP 3808182 (1974) & CA 79, 91572 (1974)

Vinylhaloacetylene Polymers.

$(\text{CH}_2:\text{CH}.\text{C}\equiv\text{CX})_n$, $\text{C}_4\text{H}_3\text{X}$, where X is a halogen. Prepn is from hypohalites and vinylacetylene. According to Blatt (Ref 2) these polymers are expl

Refs: 1) Beil, not found 2) Blatt, OSRD 2014 (1944)

Vinylidene Chloride. See in Vol 5, D1210-R to D1211-L under "Dichlorethylene" and in Vol 8, P345-Table, under "Polymerization, Violent". The following *Addnl Refs* are also pertinent: *Note:* CA Registry No is [75-35-4]. 1) R.C. Reinhardt, "Handling Vinylidene Chloride", *C&EN* 25, 2136 (1947) & *CA* 41, 6075 (1947) [Reported is the use of phenol-type polymerization inhibitors to prevent formation of expl peroxides. Caution is expressed against prolonged or repeated skin contact] 2) L.G. Shelton et al, "Vinyl and Vinylidene Chloride" in "Vinyl and Diene Monomers—Part 3", E.C. Leonard, Ed, J. Wiley, NY (1971), 1255–89 [A survey of the entire spectrum of information on vinylidene chloride, circa 1971, is available in this text. Of particular interest is the data on peroxide formation. This expl compd forms as low as -40° . The reaction product with ozone is considered particularly dangerous. If the peroxide content of the monomer is more than 15% the mixt formed can detonate from either a slight mechanical shock or heat. Recommended monomer purification requires washing with 10% aq Na hydroxide or 5% aq Na bisulfate soln. The authors caution that large scale equipment should be filled with w during shut-down, and that air or oxygen be prohibited from contacting the monomer, or instead, that phenolic polymerization inhibitors be used] 3) M. Mansson et al, "The Enthalpies of Combustion and Formation of . . . 1,1-Dichloroethene", *JChemThermodyn* 3, 547–51 (1971) & *CA* 69, 26662 (1972) [Reported are enthalpies of combustion and formation at 25° ; $-24.3 \pm 1.4\text{kJ/mole}$ (liq) and $+2.2 \pm 1.4\text{kJ/mole}$ (gas), resp] 4) R.L. Brennan, USP 3741831 (1973) [The inventor suggests use of vinylidene chloride to increase the sensy of an expl compn. Thus, the monomer (1.2) is mixed with powdered Mg/Al alloy (50/50 by wt) (31.7), AN (59.0), W (0.9), Mg oxide (6.0), and assorted

resins (1.2%) and then cast in a mold to form a hard mass] 5) R.D. Huffman, "Health and Environmental Impacts: Task 1, Vinylidene Chloride", EPA 560/6-76-023, Tracor Jitco, Rockville, Contract 68-01-4116, Task 1 (1976) [A summary of the information available indicates that the compd is readily absorbed from the gastrointestinal and respiratory tracts. The authors report that the fate of this substance following absorption had not been elucidated as of 1976. The minimum effective toxic concn of vinylidene chloride had been found to vary from the Manufacturing Chemists Association TLV of 5mg/m^3 (1972) to Pendergast et al's (*Toxicol-ApplPharmacol* 10 (2), 270–89 (1976) observation that toxic effects in animals occurred at 101mg/m^3 upon 90-day exposure. The authors also report that the American Council of Government and Industrial Hygienists had set the TLV at 10 ppm in 1972] 6) M.H. Kaufman, "Novel Inhibitor System for Double-Base Propellant", USP 2954063 (1976) [Suggested is the use of a layer of vinyl chloride-vinylidene chloride copolymer, bonded to the surface of a double-base rocket proplnt grain by means of a block copolymer adhesive contg blocks of vinyl chloride-vinylidene chloride copolymer, plus a block of polyurethane to act as a burning rate inhibitor by controlling the ignitability of the surface area of the proplnt. Hence, the designed ballistic performance of the proplnt is achieved] 7) H.S. Warren & B.E. Ricci, "Vinylidene Chloride. I. An Overview. II. A Literature Collection, 1947 to 1977", *ORNL/TIRC-77/3* (1978) & *CA* 89, 219959 (1978) [Abstracted are 54 publications dealing with various aspects of vinylidene chloride technology and toxicity]

Vinylidene Chloride Monoperoxide. When vinylidene chloride is stored without a polymerization inhibitor (such as tertiary butyl catechol or other phenol type inhibitors) at a temp of between -40 and $+25^\circ$ in the presence of air or oxygen, the O_2 dissolves to form a peroxide compd of undetermined nature which is an *extremely violent expl*. This peroxide seems to act as a polymerization catalyst because its formation is often accompanied by the pptn of a flocculent vinylidene chloride polymer. Since the peroxide is absorbed on the pptd polymer, any separation

of the polymer by filtrn, evapn or drying will yield a more or less expl substance. It has been found exptly that any compn contg more than 15% of the peroxide will, if dry, deton from a sl mechanical shock or heat

Compns contg reaction products of vinylidene chloride and ozone are also extremely dangerous. See also in Vol 8, P344-45 under "Polymerization, Violent", and the preceding entry

Refs: 1) Beil 1, 186 2) Anon, "Handling Precautions for Vinylidene Chloride Monomer", pamphlet, Dow Chemical Co, Midland (1951)

Vinylidene Fluoride (VF₂). See in Vol 6, F133-L under "1,1-Difluoroethylene . . ." and the following *Addnl Refs*: 1) R.A. Prosser & J.T. Stapler, "A New Approach to Protection Against Intense Light Energy", Natick Labs (1968) (AD 837162) [The authors report on the pyrolysis mechanism which makes poly-VF₂ the best means of protection from the intense thermal energy generated by a thermonuclear expln from among a list of other candidates including polyvinyl fluoride, polyethylene, polytrifluoroethylene and Teflon. Poly-VF₂, according to the authors, provides the largest amt of polyene structure of all of the polymers examined. This type of molecular structure is termed chromophoric as it can absorb thermal (photon induced) energy. As this energy is absorbed by poly-VF₂, HF is released which cools the polymer and cannot, of itself, ignite] 2) R.S. Brown et al, "Surface Reaction Effects on the Acoustic Response of Composite Solid Propellants", AIAAJ 6 (3), 479-88 (1968) & CA 68, 70784 (1968) [The excellent burning rate control of AP proplnts using a grain coating comprised of Viton A (a copolymer of VF₂ and hexafluoropropylene) is attributed to the oxidation resistance of the copolymer by the authors. They indexed this effect by examining the acoustic response of various proplnt coatings including VF₂ during proplnt combstn over a frequency range of from 150 to 5000cps. Their parametric studies revealed that high ratios of the max acoustic response function to the burning rate pressure exponent occur when the net heat release at the proplnt surface (pressure dependent reactions plus pyrolysis reactions) is

nearly zero, or is exothermic] 3) W.W. Woods & D.A. Shock, "Encapsulated Propellant Preparation from Fluorinated Monomers by Using Radiation", USP 3441455 (1969) & CA 70, 14738 (1969) [The inventors claim a γ radiation technique which reduces the time required for proplnt prepn, enables prepn at lower temps than prior processes, and gives uniform, crack-free grains. Thus, a cast proplnt contg powdered Al (16), AP (64), an equimolar mixt of VF₂, vinyl fluoride and perfluorovinyl chloride (18) and low mw polystyrene (2 wt %) is prepd by stirring the monomers and the polystyrene in a pressure vessel until dispersion occurs and the viscosity reaches 1000 cp, then adding the fuel and oxidizer, forcing the mixt into a casing, and irradiating it for 12 hrs at 10⁵ rep/hr at 70°F and 500 lbs pressure. The irradiation process solidifies the proplnt in the casing] 4) L.E. Wolinski, "Fluorovinyl Monomers", in "Vinyl and Diene Monomers", E.C. Leonard, Ed, J. Wiley, NY (1971), 1321-28 [This survey article presents circa 1971 information on all aspects of VF₂. Several facets of this article are of interest; the expl concn limits of the monomer with air is reported as 5.8 to 20.3%, and the fact that spontaneous polymerization of the monomer does not occur] 5) W.L. Elban, "The Development of an Inert Simulant for HNS/Teflon Explosive", NOL TR 72-255 (1972) [An inert simulant for HNS/Teflon has been developed with non-expl properties that nearly match those of the expl. The compn, which contains VF₂ (66.0), melamine (10.0) and Teflon-7C (24.0%), closely duplicates the pressed d, thermal conductivity and specific heat of the expl while having similar processing and machining characteristics] 6) R.W. James, "Propellants and Explosives", Noyes Data Corp, Park Ridge (1974), 166-69 [Presented in this review of the patent literature circa 1974 is a patent of an invention by M.H. Kaufman (USP 3734788 (1973)) covering a series of proplnt compns incorporating a binder of Viton-A (a copolymer of VF₂ and perfluoropropene). Kaufman claims the proplnts attain a theoretical d impulse value of 490 to 622g-sec/cc and an increase in tensile strength over the then standard compns. Typically, Viton-A (18.5), Na Azide (9.1), AP (54.6), and Al (18.15 wt %) are formed into the compn of the invention. Claimed parameters are: burn-

ing rate 0.37inch/sec at 1000psi and 0.78inch/sec at 4000psi. The patent also covers a series of other compns contg Viton-A and presents measured impulse data generated by the burning of these compns in a test device. Thus, a compn consisting of Viton-A (20), AP (65), and Al (15%) has a measured I_{sp} of 283] 7) J.B. Eldridge et al, "Fluorocarbon Solid Propellant with Burning Rate Modifier", USP 3876477 (1975) & CA 83, 118055 (1975) [Here Viton-A and Teflon are used as proplnt binders. Claimed is increased burning rate, low pressure exponents and/or low temp coefficients. Typically, Viton-A (15), Teflon (25), Al (20), K perchlorate (35), NaF (2.5) and K dichromate (2.5 wt %) are mixed to form a slurry which is pptd with hexane to form the invented proplnt] 8) R.P. Cornia & R. Reed, "Compositions for Producing Flickering Signals", USP 3983816 (1976) & CA 85, 194940 (1976) [Suggested are pyrot compns contg Viton-A which upon burning produce flickering signals of flame and smoke and emit IR and radar signals. Thus, a castable compn is prepd from powdered Mg (24), AP (15), Cs nitrate (1), hexachlorobenzene (20), Viton-A in 1,1,7-trihydrodecafluoroheptyl acrylate (39.1), glycidyl methacrylate (0.1), benzoyl peroxide (0.5), triethyleneglycol diacrylate (0.2) and propyleneglycol monoacrylate (0.1 wt %) with the desired pyrot properties] 9) E.L. Church et al, "Plastic Piezoids for Fuze Applications", FrankfordArs, Phila (1976) (ADA 025987) [Several concepts for the use of poly-VF₂ as a piezoid material in fuzing applications are reported. In one concept, the polarized polymer is used as an impact-energy generator transducer for round ign. Another concept involves its use as a piezoelectric optical window, which upon round impact generates sufficient energy to light a miniaturized lamp, thus activating a photo-detector whose output functions the fuze. Addnly, the authors report that ". . . PVF₂ sheets are transparent in the visible and near infrared spectral regions, including the neodymium laser emission wavelength at 1.06 microns. Hence, PVF₂ can serve as a piezoelectric window for missiles or guided projectiles with active or passive optical/infrared seeker systems. In addition, its pyroelectric behavior can utilize the aerodynamic heating of a projectile in flight as a second arming environment . . ."] 10) R.H. Pirtchard,

"Compatibility of TATB PBX with Weapons Materials", *PlastOtherMaterExplosProplntsSymp*, IIIA (1976) & CA 87, 87227 (1977) [Reported is the use of Viton-A, Kel-F 800 and Estane 5702-F1 as a binder for TATB contg expl compns. Compatibility tests (the object of the study with stainless steel, V, polyamide film and several sealant/adhesives at 120° for 1 to 4 months revealed no definite reaction. However, it was concluded that the major cause of gas evolvn and chemical interaction between expl and test materials is the presence of w]

Vinyl Lithium. CH₂:CHLi, C₂H₃Li; mw 33.99; violently pyrophoric fine white powder; mp, decomps on heating. Sol in eth; insol in benz or petr eth. Peptn is by metal exchange between tetravinyl Pb and Li in eth at RT giving a 55% yield. Freshly prepd vinyl Li is violently pyrophoric, giving a brilliant red flash on contact with air. It can be used to vinylate compds such as tributyltin to tributylvinyltin. When stored in an inert atm, even at -26°, it will polymerize to a less active substance
Refs: 1) Beil, not found 2) E.C. Juenge & D. Seyferth, "Synthesis and Isolation of Vinyl-lithium . . .", *JOC* 26, 563-65 (1961) & CA 55, 17482 (1961) 3) Bretherick (1979), 363

Vinyl Nitrate Polymer. See in Vol 8, P356-L to P358-R under "Polyvinyl Nitrate (PVN)" and the following *Addnl Refs*: 1) R.A. Strecker & F.D. Verderame, "Isotactic and Syndiotactic Polyvinyl Nitrates", USP 3965081 (1976) & CA 85, 162921 (1976) [The inventors claim the prepn is isotactic PVN, with a softening pt of 65-90°, to be used with either RDX or HMX in suggested proplnt formulations. Thus, anhydr nitric acid (143) is added to a slurry of isotactic PV alcohol (26.5) and acetic anhydr (286g) at -10 to -15° and held for 1 hr. The temp is then allowed to rise approx 20° in 90 minutes, and stirring is continued for 45 minutes more. The product is pptd by drowning in ice-w, then dissolved in acet and repptd from a 5% Na carbonate soln] 2) R.A. Strecker, "Stereo-regular Polyvinyl Nitrate", **ARLCD-MR-80003** (1980) (AD-E400456) [The author reports on various nitrating procedures for PV alcohol to

produce isotactic PVN and the thermal stability of these products. He concludes that stabilization of isotactic PVN to a level comparable to that of NC can be achieved only when the polymer is dissolved and re-pptd]

Vinyl Polymers. See in Vol 8, P353-R to P358-R under "Polyvinylacetate, Polyvinylalcohol, Polyvinyl Chloride or Polyvinyl Nitrate (PVN)" and in this article under appropriate entries

Vinyl Pyridines and Derivatives

α -Vinylpyridine (Pyridine-2-ethenyl).

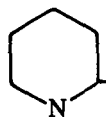

CH:CH_2 , $\text{C}_7\text{H}_7\text{N}$; mw 105.14; colorl liq; bp $159-60^\circ$; d 0.980g/cc at $20/4^\circ$; RI 1.5449 at 20° . Infinitely sol in w; v sol in acet, chl, ethanol and eth. CA Registry No [19295-34-2]. Prepn is by dehydration of 2-(2'-hydroxyethyl) pyridine (Ref 2, p 137, & Ref 4)

According to Refs 3 & 5, the compd exhibits a tendency to polymerize sponty with expl violence. Karakuleva et al (Ref 3) suggest the use of amine nitrates to suppress this tendency and prevent the occurrence of such explns
 Refs: 1) Beil 20, 256 2) J.P. Schroeder & D.C. Schroeder, "Miscellaneous Vinyl Monomers", in "Vinyl and Diene Monomers-Part 3", E.C. Leonard, Ed, J. Wiley, NY (1971), 1376-93
 3) G.I. Karakuleva et al, "Inhibition of Spontaneous Polymerization of N-Vinylpyridines", USSRP 396349 (1973) & CA 82, 58458 (1975)
 4) ChemRubberHndbk (1978), C-473
 5) Bretherick (1979), 630

2-Vinylpyridinium Perchlorate Polymer.

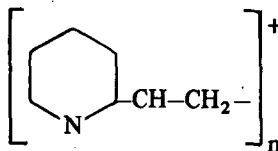

ClO_4^- ; a brittle solid.

Prepn is by reacting polyvinylpyridine with an aq soln of 70% perchloric acid, and then bringing the soln to a boil. The product is pptd on cooling and is then oven-dried at 85° . Jenkins et

al (Ref 2) claim that this compd burns readily in an inert atm, and is therefore suitable for expl and proplnt purposes

Refs: 1) Beil 20, 256 2) H.P. Jenkins et al, "Poly (Vinylpyridinium Perchlorates)", USP 2989390 (1961) & CA 55, 25258 (1961)

γ -Vinylpyridine (Pyridine-4-ethenyl).

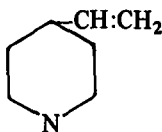

C_7H_7 ; mw 105.14; red to dk brn liq; bp 65° at 15mm; d 0.9800 at $20/4^\circ$; RI 1.5449 at 20° . Infinitely sol in eth; sol in ethanol and w. Prepn is by dehydrohalogenation of 2-chloro-4-ethyl pyridine (Refs 3 & 5)

The same comment and refs for spontaneous expl polymerization pertains here as it does for the α -isomer described above (Refs 4 & 6)

A possibly expl picrate is prepd by reacting a diphenyl ether soln of 4-vinylpyridine styrene copolymer (10:90) with an equivalent of PA, also dissolved in diphenyl ether. The 4-vinylpyridine styrene copolymer picrate product is sol in acet and insol in w (Ref 2)

Refs: 1) Beil 20, [166] 2) R.M. Fuoss & G.I. Cathers, ". . . Picrates of 4-Vinylpyridine-Styrene Copolymers", JPolymerSci 2 (1), 12-15 (1947) & CA 41, 4996 (1947) 3) J.P. Schroeder, "Miscellaneous Vinyl Monomers" in "Vinyl and Diene Monomers-Part 3", E.C. Leonard, Ed, J. Wiley, NY (1971), 1376-93
 4) B.I. Karakuleva et al, "Inhibition of Spontaneous Polymerization of N-Vinylpyridines", USSRP 396349 (1973) & CA 82, 58458 (1975)
 5) ChemRubberHndbk (1978), C-473
 6) Bretherick (1979), 630

Vinyl Compound Toxicity. Listed in Table 1 are the carcinogeneity, lowest toxic concn (TC_{LO}), lethal dose (LD), threshold limit value (TLV), avenue of body entry (Entry mode), and the appropriate refs for a number of vinyl compds. The primary toxic effects of most vinyl compds (except where lethality and carcinogenic effect are noted) are those of skin irritation, corneal erosion, headache, nausea and vomiting

Table 1
Vinyl Compound Toxicity

Compound	Carcinogen	TC _{LO} , ppm	LD, mg/kg	TLV, ppm	Entry Mode	Refs
Vinyl Acetate	No	4000/4 hrs (rat)	—	10	Inhalation	1 & 3
Vinyl Acetonitrile	—	—	500 (rat)	—	Intraperitoneal	3
Vinyl Amine	No	—	115 (rat)	—	Oral	3
Vinyl Benzene	No	—	—	0.5	Any	1
Vinyl Butyrate	No	—	—	100	Any	1
Vinyl Butyrate	No	4000/4 hrs (rat)	8530 (rat)	—	Inhalation & Oral	3
Vinyl Carbinol	No	—	—	2	Inhalation & Percutaneous	1
Vinyl Chloride	Yes (500ppm, intermittent)	20 Cardiovascular	500 (rat LD ₅₀)	None detected	Inhalation	2 & 3
Vinyl Cyanide	No	—	82 (rat LD ₅₀)	20	Any	1
Vinyl Ether	No	51223 (mice)	—	—	Inhalation	3
Vinyl Ethylene	No	—	8160 (rat LD ₅₀)	1000	Inhalation	1 & 3
Vinylidene Chloride	Same as Vinyl Chloride	—	—	—	—	3
Vinyl Pyridine isomers: 2-Aminopyridine Pyridine	No No	— —	— —	0.5 5.0	All All	1 & 3 1 & 3
Vinyl Styrene	No	—	4040 (rat LD ₅₀)	—	Oral	3
Vinyl Toluene	No	—	—	100	Inhalation & Oral	1 & 3

Refs: 1) E.R. Plunkett, "Handbook of Industrial Toxicology", Chemical Publishing Co, NY (1976), 13, 16, 67, 179, 354, 380, 417, 434 & 437 2) M. Settig, "Hazardous and Toxic Effects of Industrial Chemicals", Noyes Data Corp, Park Ridge (1979), 441-44 3) Sax (1979), 1086-90

Violette (Poudre) (Fr). Violette proposed in 1871 an expl mixt made by melting Na nitrate 62.5 and Na acetate 37.5 p together. Although the mixt is hygroscopic, it explds on heating to about 350°

Note: In order to achieve complete combustion according to the following equation:

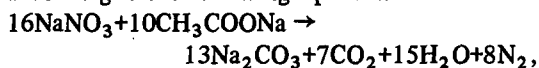

the stoichiometric mixt should contain 62.385 p of Na nitrate and 37.615 p of Na acetate. The calcd temp of expln would be 2276.6°, heat of combstn 1605.4cal/g at const vol and 1580.9 cal/g at const press

Ref: Daniel (1902), 786-87

Viper Light Anti-Tank Weapon. US light and inexpensive expendable one-man anti-tank weapon weighing less than 7 lbs (3.165 kgs), and firing a rocket with improved propulsion and a more powerful shaped-charge warhead than that used with the M72 series

The rocket is supplied packed in a container/launch tube made of a fibreglas material which is in two telescoped sections. Attached to the outer tube of the container are a folded shoulder-piece and rear sight, and a folded foresight is attached to the inner tube. Before firing, it takes only a few moments to extend the launch tube by pulling out the inner tube until it locks in the extended position, and to erect the rear sight and shoulder-piece – the foresight is self-erecting (Fig 1)

The simplicity of the sighting is likely to restrict the useful battle range to less than 300m and may well inhibit the use of the weapon in poor light. It remains to be seen how good the warhead will be against modern tanks, but it seems likely that it will be too small for the frontal armor of the latest Soviet models, and the method of attack may have to be restricted to the side armor

CARRY MODE

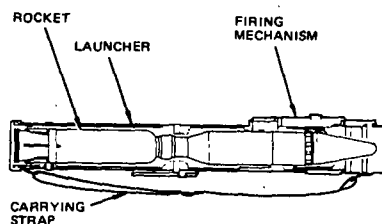

READY-TO-FIRE MODE

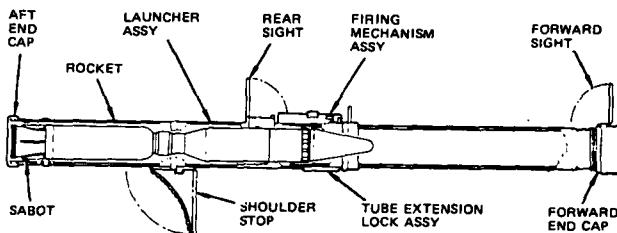

Fig 1 The Two Modes of Viper

The new missile uses a new fast-burning carborane proplnt which is entirely consumed before the missile leaves the launch tube. Its shaped-charge HEAT warhead is said to be more lethal than that of the earlier weapon. Viper has been under development by the General Dynamics Corp since Feb 1976

Ref: J. Wicks, Ed, "Jane's Infantry Weapons, 1979-80", Fifth Ed, Franklin Watts Inc, NY (1979), 526

Virgo. Swed 120-kg fragmentation bomb developed for use against diverse targets such as landing craft, aircraft on the ground, anti-aircraft weapons, field artillery, light armored and unarmored vehicles, etc. Designed to disperse a large number of fragments of a pre-determined size and weight at high striking velocity, the bomb incorporates many unique safety devices to ensure that any logistical or tactical mission can be safely and effectively accomplished. The bomb is designed for one-point suspension in ejector release units

To meet the demands of tactical requirements of being used at low altitudes the bomb is equipped with a built-in brake parachute which will retard the bomb sufficiently to give the

aircraft enough lead distance to be safe at the moment of burst. The bomb can be dropped from higher tactical altitudes with or without the brake parachute. As the bomb is designed for supersonic speeds it is equipped for protection against aerodynamic heating. A proximity fuze is fitted in the nose of the bomb, and this is based on the capacitance principle. The fuze system causes the bomb to detonate a few meters above the target or the ground vegetation. The use of this proximity fuze system substantially increases the lethal area in comparison with bombs fitted with impact fuze systems. The expl charge is 30 kg of RDX/TNT. It is manufd by the FFV Ordnance Division, Sweden
 Ref: R.T. Pretty, Ed, "Jane's Weapon Systems, 1979-80", Tenth Ed, Franklin Watts, NY (1979), 456-57

Virite. See under "Italian Explosives and Related Items" in Vol 7, I181-R

Visol. Ger trade name for a liq rocket fuel (brennstoffe) of variable compn, such as:
 a) Vinylethyl ether straight or mixed with some aniline to promote combustion. When used in liq rocket propellants in the proportion of 0.23 p of Visol per one p of 100% nitric acid, the theoretical specific impulse was 214 lbs/lb/sec (Ref 1).
 b) Vinylisobutyl ether 40, isopropyl alc 40 and water 2%. The remaining 18% consisted of four other ingredients including 1% of a dope to control the ignition delay time (Ref 3)

Visol-6, according to Refs 2 & 4, was a Ger trade name for vinylethyl ether. It was used during WWII as a liq rocket propelling fuel in guided missiles such as the Enzian E-4, Rheintochter R-3 and Wasserfall. Absolute nitric acid was used as the oxygen carrier

Ref 5 defines Visol-1, -4, and -6 as vinylethyl ether and mixts with isopropyl alcohol and vinylbutyl ether

Refs: 1) J. Collins, "Rockets and Directed Missiles", CIOS Rept 28-56 (1945), 19 2) Anon, Army Ordnance 31, 30 (1946) 3) Anon, "German Explosive Ordnance", TM 9-1985-2 (1953), 220 4) B.T. Fedoroff et al, "Dictionary of Explosives, Ammunition and Weapons (German Section)", PATR 2510 (1958), Ger

215-16 5) R. Meyer, "Explosives", Verlag Chemie (1977), 357

Vitesse de Combustion (Fr). The *linear burning rate* of a proplnt is the rate at which the chemical combustion reaction is propagated by both thermal conduction and radiation. The combustion gases flow in the direction opposite to that of the combustion process (unlike in detonation). The burning rate is equivalent to the distance normal to any burning surface of a proplnt grain burned thru in unit time. It varies not only with compn, pressure, temp and physical structure of the proplnt (porosity, granulation, and density, but also with the shape of the proplnt grain - flakes, balls, tubes, multiperforated tubes, etc, and including the more complicated shapes of rocket proplnt charges). In rocket technology the term "burning rate" is usually employed in the more restricted sense of the rate of propagation of combustion at constant pressure in the rocket motor

The various parameters influencing the progress of combustion are correlated in Charbonnier's equation:

$$\frac{dz}{dt} = A \cdot \phi z \cdot p^a$$

- where $\frac{dz}{dt}$ is the volumetric combustion rate, or $\frac{dz}{dt}$ when multiplied by the density of the propellant, the mass flow
 A is the "vivacity" or "quickness" (see article which follows)
 ϕ is the form function which may vary thruout the progress of combustion (eg, due to the increase in the diameter of the longitudinal holes of multiperforated tubular grains)
 z is the ratio of the volume of proplnt already burned at any given time to the initial volume of the proplnt prior to the beginning of reaction
 p is the pressure; the higher the pressure, the greater the heat transfer onto the combustion surface
 a is the pressure exponent which in high pressure ranges is close to unity, but in rocket proplnt formulations containing special additives may be close to zero ("plateau burning") or negative ("mesa burning")

In a confined volume (eg, in a ballistic closed vessel or bomb) the pressure increases to the maximum value p_{\max} ; in a weapon, it decreases beyond the maximum point because the combustion volume increases due to the movement of the projectile

If the gases are continually flowing out, as in the case of a rocket motor, the pressure remains almost constant thruout the combustion period. The linear burning rate and its variation with temp and pressure can be determined in a Crawford type strand burning rate bomb. The temp coefficient of the burning rate is the variation per degree of temp increase at constant pressure. The dependence on pressure is characterized by the pressure exponent

See also under "Burning and Burning Characteristics of Propellants" in Vol 2, B346-L to B355-R, and under "Propellants, Solid" in Vol 8, P402-L to P406-R

Ref: R. Meyer, "Explosives", Verlag Chemie, NY (1977), 39-40

Viton. A trademark of the E.I. duPont de Nemours & Co for a series of fluorelastomers based on the co-polymer of vinylidene fluoride and hexafluoropropylene with a repeating structure of $[-CF_2-CH_2-CF_2-CF(CF_3)-]_n$; white, transparent solid; sp grav 1.72-1.86. Resistant to corrosive liqs and chemicals up to 600°F, and useful in continuous service at 400-500°F. The material is resistant to weather, ozone, flame, oils, fuels, lubricants and many solvents

According to Refs 2 & 3, Viton-A is used in many expl formulations developed by the Lawrence Livermore Laboratory, such as LX-04, LX-07, LX-10-0, LX-10-1 and LX-11-0 (see Vol 8, P68-Table 3). For proplnt usage see Vol 8, P413-L & R; for pyrots, see Vol 8, P514-Table 9, and in Vol 9 under "Tungsten". Other applications are detailed under "Vinylidene Fluoride" in this Vol

Refs: 1) L.E. Wolinski, "Fluorovinyl Monomers" in "Vinyl and Diene Monomers-Part 3"; E.C. Leonard, Ed, J. Wiley, NY (1971), 1321 & 1327
2) B.M. Dobratz, "Properties of Chemical Explosives and Explosive Simulants", UCRL-51319, Lawrence Livermore Lab, Livermore (1974).
3) C.S. MacDougall et al, "Composition Analysis of Viton Used in Explosives", MHSMP-75-24N,

Mason & Hanger, Silas Mason Co (1975)
4) CondChemDict (1977), 921

Vivacité de Combustion des Poudres. See under "Coefficient de Vivacité des Poudres" in Vol 3, C390-R to C391-L, and under "Propellants, Solid" in Vol 8, P404-R

Voigt Explosives. Adolf Voigt of Giessen, Ger, took out patents in several countries in 1911 for safety expls of the following compns:

No	1	2	3	4
Mononitrophenol or Na mononitrophenol-sulfonate, %	25	25	22.5	25
K or Na nitrate, %	65	50	45	65
K perchlorate, %	10	25	22.5	—
Amm nitrate, %	—	—	10	—
TNT, %	—	—	—	10

He claimed that these expls were 30% more powerful than the usual "nitro" powders of the day, and that by the addition of Amm nitrate they could be made to possess a high degree of safety

Ref: Colver (1938), 285-86 & 707

Volatiles, Total. Three tests are current in the USA for the determination of total volatiles in solid proplnts. They are all contained in "Military Standard-Propellants, Solid: Sampling, Examination and Testing", MIL-STD-286B (1 Dec 1967) with Notice 1 (15 July 1969) and Notice 3 (30 Dec 1975). In the interest of accuracy, these procedures will be reproduced verbatim:

Method 103.1.3 (15 July 1969)

Total Volatiles (Dish and Cone Method)

1. SCOPE

1.1 This method is used for determining the moisture and volatile solvent content of sheet propellant (such as M-8 propellant) and other propellants where the chief constituent evolved is moisture. The method is generally not applicable to propellants not in sheet form.

Note: The cone is intended to prevent loss of nitro-glycerin by condensing any that has volatilized.

2. SPECIMEN

2.1 The specimen shall consist of approximately 10 gm of the propellant, weighed to within 0.2 mg.

3. APPARATUS

3.1 Aluminum dish with glass cone (Fig 1).

3.2 Closed steam plate (surface temperature $90^{\circ} \pm 5^{\circ}\text{C}$), or steam heated, forced draft type oven maintained at $90^{\circ} \pm 5^{\circ}\text{C}$.

3.3 Desiccator containing an indicating calcium sulfate desiccant (Drierite).

4. PROCEDURE

4.1 Prepare the specimen as described in Method 509.3.

[*Editor's Note:* The following insert is **Method 509.3**, "Preparation of Propellant Samples":

1. SCOPE

1.1 This method is used for preparing sheet and granular propellant for analysis.

Warning: Procedures involving grinding should not be used for propellants containing potentially hazardous oxidants, such as chlorates and perchlorates.

2. SPECIMEN

2.1 The specimen shall consist of a portion of propellant selected in accordance with the applicable propellant specification, and weighed in accordance with the test method used.

3. APPARATUS

3.1 Laboratory mill (Wiley, Standard Model No. 2G, or equivalent), equipped with a shield and an explosion-proof motor (class 2).

3.2 Beryllium alloy shears or a razor blade.

3.3 Powder cutter (modified papercutter, preferably with a beryllium alloy blade).

3.4 Glass bottle, stoppered.

4. PROCEDURE

4.1 Sheet propellant. Cut sheet propellant into pieces approximately 1/8-inch square, using razor blade or shears. Place cut propellant immediately in a stoppered glass bottle.

Note: If grinding of sheet propellant is specified, the propellant must be brittle. Soft and pliable sheet can be made brittle by chilling the propellant container in an ice bath. Grind sheet propellant as prescribed for small grains (par. 4.2).

4.2 Small grain propellant. Grind small grain propellant (0.2 gm or less) in the laboratory mill as follows:

(a) Prepare the mill for grinding by placing the 20-mesh screen between the grinding chamber and the receiving container, and firmly clamping the rotor cover plate in position.

(b) Place the shield in proper position.

(c) With motor running, grind a few grains at a time, checking the temperature of the machine between grindings.

Warning: Allow sufficient time for the rotor and blades to cool before grinding additional samples of the propellant.

(d) Place ground propellant immediately in a stoppered glass bottle.

4.3 Large grain propellant. Cut large-grain propellant (grains larger than 0.2 gm) into slices approximately 0.17 mm thick, using the powder cutter. Cut these slices into pieces approximately 1/8-inch square. Place cut propellant immediately in a stoppered glass bottle.

Note: For solvent extractive matter determination, grind the slices as prescribed for small grains (par. 4.2).]

Continuation of: **Total Volatiles (Dish and Cone Method)**

4.2 Weigh the dish and cone (par. 3.1.), place the specimen in the dish, and cover it with the cone.

4.3 Heat the specimen for 2 hours.

4.4 At the end of 2 hours, place the covered dish in the desiccator, and cool to room temperature.

4.5 Determine the loss in weight, and calculate the loss as the percentage of volatiles in the propellant specimen.

$$\text{Percent of volatiles (by weight)} = \frac{W_1 - W_2}{W_2} 100$$

W_1 = Weight of specimen before drying, gm.
 W_2 = Weight of specimen after drying, gm.

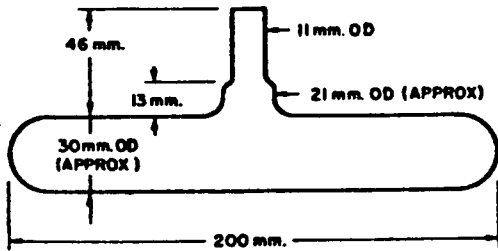

Fig 1 Dish and Cone

Method 103.3.3 (1 Dec 1967)

Total Volatiles (Solution—Evacuation Method)

1. SCOPE

1.1 This method is used for determining the total volatiles content of either single-base, double-base, or triple base propellants.

2. SPECIMEN

2.1 The specimen shall consist of approximately 2 gm of the propellant prepared with minimum atmospheric exposure in order to reduce loss of volatiles.

3. APPARATUS

3.1 Solution tubes (Fig. 1).

3.2 Steel balls, 5/16-inch diameter.

3.3 Tubing, rubber, 5/16-inch bore, 3/16-inch wall.

3.4 Vacuum line assembly (Fig. 2).

3.5 Wire screen tray (Fig. 3).

3.6 Protective drying tubes (Fig. 4), contain-indicating desiccant.

3.7 Vacuum pump capable of maintaining a pressure (absolute) of 5 mm of mercury.

3.8 Wire holders for solution tubes (Fig. 5).

3.9 Counterpoise (Fig. 6).

3.10 Pyrex glass wool, or equivalent.

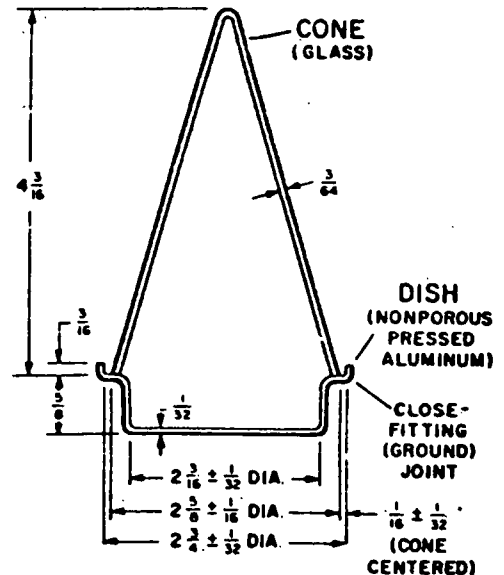

DIMENSIONS ARE IN INCHES AND ARE APPROXIMATE UNLESS TOLERANCE IS GIVEN.

Fig 1 Solution Tube

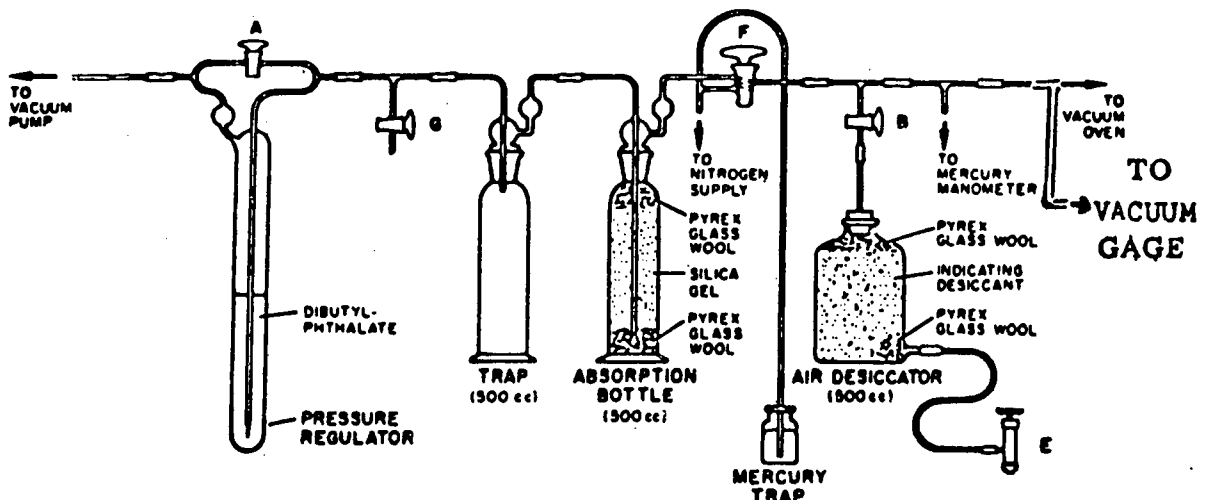

Fig 2 Vacuum Line Assembly

3.11 Oven containing a rocking device with evacuation manifolds (Central Scientific Co., Cat. No. 95105-A modified by addition of a safety latch, or equivalent).

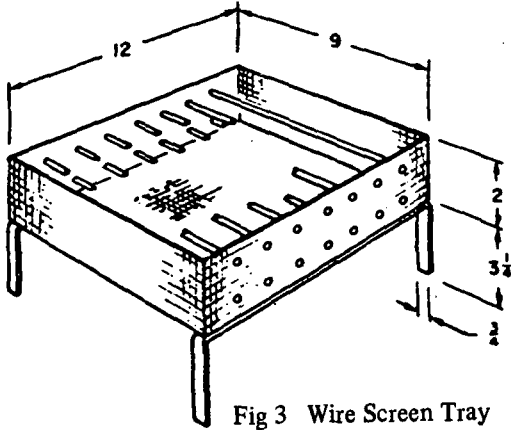

Fig 3 Wire Screen Tray

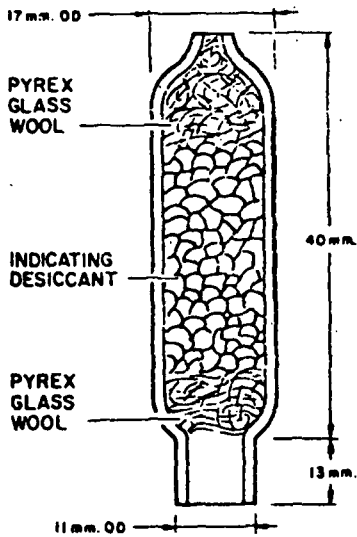

Fig 4 Protective Drying Tube

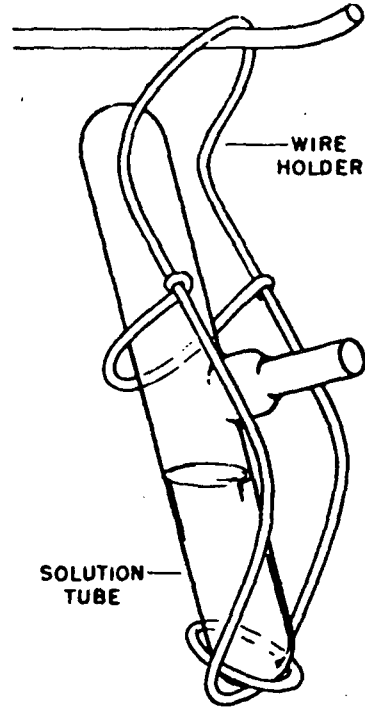

Fig 5 Solution Tube Holder

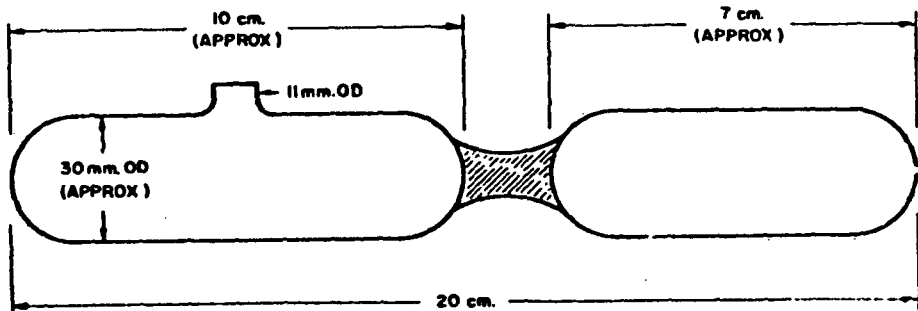

Fig 6 Counterpoise

4. MATERIAL

4.1 Dibutylphthalate, prepared as follows:

- (a) Dissolve 1 gm of diphenylamine in 100 ml of hot dibutylphthalate.
- (b) Pour this solution into 500 ml of dibutylphthalate; stir vigorously.
- (c) Add dibutylphthalate to make 1 liter; stir vigorously.
- (d) Heat the solution for 2 hours at 145° to 150°C. while bubbling dry air through it.

Note: The heating ensures that the solution will lose less than 10 mg in 50 ml during the solution-evacuation procedure, and may be omitted if previous tests show that it is unnecessary.

5. PROCEDURE

5.1 Prepare at least four solution tubes (two for the specimens, two for blanks) as follows:

- (a) Place 10 clean, dry, steel balls and 50 ml of the dibutylphthalate reagent into each solution tube.
- (b) Clean the inlet of each solution tube with absorbent cotton held by steel forceps, and insert a wad (approximately 0.2 gm) of pyrex glass wool, using the forceps.

Caution: Position the glass wool at such a point in the tube that it will not fall into the tube and will not touch the cork stopper that is to be inserted subsequently.

5.2 Precondition the solution tubes as follows:

- (a) Using 5-cm pieces of the rubber tubing, connect the solution tubes to the manifold of the rocking device in the oven, placing the tubes containing the blanks at opposite ends of the manifold. Plug or otherwise close unused manifold connections.

Note: New connecting tubing should be precleaned by boiling in a 5-percent solution of sodium hydroxide for 10 to 15 minutes, followed by a thorough rinsing, and drying at 100°C.

- (b) Connect the vacuum line assembly (Fig. 2) to the manifold of the rocking device and to the vacuum pump.
- (c) On the vacuum line assembly (Fig. 2) open stopcock A; close stopcocks B,

and G and needle valve E; and set stopcock F to connect the manifold to the vacuum pump.

- (d) Adjust the oven temperature to 85° ± 1°C., start the rocking motor, and turn on the vacuum pump. Evacuate the tubes at a pressure of 5 mm or less for 1½ hours.
- (e) At the end of 1½ hours, stop the vacuum pump and rocking motor, and slowly open stopcock B. Then slowly admit dry air to the solution tubes by gradually opening needle valve E.

Caution: If the air is admitted too rapidly, wads of pyrex wool may be drawn into the solution tubes.

(f) Wearing gloves, remove the solution tubes from the oven, leaving the connecting tubing attached to the tubes, and place them in the wire-screen tray (Fig. 3). Immediately attach a protective drying solution tube (Fig. 4) to the inlet of each solution tube to prevent the admission of atmospheric moisture. Allow the tubes to cool to room temperature (approximately 45 minutes).

(g) When the solution tubes have cooled, remove the protective drying tubes and connecting tubing, and insert No. 1 cork stoppers.

Caution: The solution tubes must be kept tightly corked hereafter to prevent absorption of atmospheric moisture by the very dry dibutylphthalate, except during evacuation in the oven and while being weighed.

5.3 Clean and remove electrostatic charges from the solution tubes by wiping them with a wet towel and drying them with a clean lint-free cloth (without rubbing). Place the tubes in the wire-screen tray, cover them with a cloth to protect them from dust, and allow them to stand near the balance for at least 30 minutes to attain equilibrium with the moisture content of the air.

Caution: After the tubes have been conditioned they should not be touched with the fingers until they have been weighed. When handling the tubes, grip the inlet tube only, after covering the inlet with a tissue paper.

5.4 Cut sheet and large grain propellant as described in Method 509.3, paragraphs 4.1 and 4.3, respectively. Use small grain propellant as

received. Take at least two specimens.

5.5 Remove the cork stoppers from two of the prepared solution tubes, and take out the wads of glass wool, using forceps. Add one of the accurately weighed specimens of the propellant to each, using a small metal funnel (9-mm od outlet) to prevent adherence of the propellant to the walls of the tube. Reinsert the wads of glass wool.

Note: Propellants soften and tend to gelatinize when added to dibutylphthalate solution. Therefore, the solution tubes should be rocked as soon as possible after the addition so that the propellant does not adhere to the walls of the tube and prevent the steel balls from moving.

5.6 Support the tubes in wire holders (Fig. 5), and weigh each solution tube (including blanks) to within 1 mg, using the counterpoise (Fig. 6) on the right-hand side of the balance.

Note: The counterpoise approximates the weight, volume, and exterior surface area of a solution tube containing 10 steel balls and 50 ml of dibutylphthalate. It should be kept standing near the balance, covered with a cloth to protect it from dust. *Do not wipe the counterpoise;* wiping will disturb its equilibrium with the prevailing temperature, pressure, and humidity.

5.7 Shake the tubes, if necessary to loosen any grain of propellant adhering to the walls of the tubes, and connect the tubes to the manifold of the rocking device in the oven. Plug all unused manifold connections.

5.8 As soon as all the solution tubes have been placed in the oven (maintained at $85^{\circ} \pm 1^{\circ}\text{C}$.), start the rocking motor.

5.9 On the vacuum line assembly (Fig. 2), check that stopcock F is turned so that nitrogen does not enter the vacuum line. Then open the valve on the nitrogen cylinder to allow a slow stream of nitrogen to escape through the mercury trap.

5.10 Close stopcocks B and G, and needle valve E, and open stopcock A. Then turn on the vacuum pump, and evacuate the solution tubes to a pressure of 1 mm of mercury or less.

5.11 When the pressure has stabilized at 1 mm of mercury, turn stopcock F to admit nitrogen slowly to the solution tubes.

Caution: Admit nitrogen slowly so that the glass wool or other foreign matter from the manifold or tubing is not carried into the solution tubes.

5.12 Evacuate the tubes again, and refill with nitrogen by operating stopcock F.

5.13 Turn stopcock F so that the nitrogen inlet is connected to the oven manifolds, open stopcock G to admit air to the vacuum line, and turn off the vacuum pump. Close stopcock G.

5.14 Allow the solution tubes to rock until sample has completely broken up or a maximum of 15 hours at a temperature of $85^{\circ} \pm 1^{\circ}\text{C}$.

5.15 At the end of 15 hours, check that stopcock G is closed, and turn stopcock F to connect the oven manifolds to the vacuum pump. Open stopcock B and needle valve E, and start the vacuum pump.

5.16 While observing the solution tubes through the glass door of the oven, gradually close needle valve E to lower the pressure in the vacuum line assembly, being careful not to close the valve so fast that the solution in the tubes boils violently.

Caution: Take approximately 10 minutes to lower the pressure to 5 mm of mercury. If the solution boils violently, there is danger of mechanical loss of the solution, and a resulting error in the determination.

5.17 When the pressure reaches 5 mm, or less, close stopcocks A and B, and continue the evacuation for 2 hours at $85^{\circ} \pm 1^{\circ}\text{C}$., and at a pressure of 5 mm of mercury or less.

5.18 At the end of 2 hours, stop the rocking motor, open stopcocks A and B, very slowly open needle valve E to admit dry air, and stop the vacuum pump.

Caution: If stopcock A is not open when the vacuum pump is shut off, the dibutylphthalate solution will flow out of the pressure regulator.

5.19 Remove the solution tubes from the oven, and cool them, as described in paragraphs 5.2(f) and 5.2(g).

5.20 Condition the tubes as described in paragraph 5.3.

5.21 Weigh the tubes, as described in paragraph 5.6 to determine the *loss* in weight of the tube containing the specimens, and the *change* in weight of the tubes containing the blanks.

5.22 Calculate the percentage of total volatiles in each of the 2-gm specimens using the equation given below. The results of calculations

must agree to within 0.10 percent. If not, repeat the analysis.

$$\text{Percent total volatiles} = \frac{100 (A + B)}{W}$$

A = Decrease in weight of specimen tube

B = Change (average) in weight of blank tubes taken algebraically

W = Weight of specimen

Note: The change in weight of the blank tubes usually is a decrease and the value substituted for B becomes a negative quantity. However, in some instances it is an increase (possibly as a result of humidity changes) and then the value substituted for B becomes a positive quantity. The blank values must agree to within 2 mg. If not, the analysis must be repeated.

Method T 103.5.1 (30 Dec 1975)

Total Volatiles (Gas Chromatographic Method)

Note: This tentative method has been prepared by the US Army Armament Command. It is optional for use by all activities

1. SCOPE

1.1 This method is used for determining water, ethyl alcohol, and diethyl ether or acetone (total volatiles) in propellant granules (or fine chopped material). It is based on extraction of the solvents from the propellant with a mixture of predried methyl ethyl ketone (MEK) and secondary butyl alcohol. By controlling the ratio of the extracting solvents, propellants containing nitrocellulose of varying nitrogen content can be analyzed by this procedure. For each propellant type, the MEK to sec.-butyl alcohol ratio should be adjusted to prevent the granules from completely dissolving.

2. SPECIMEN

2.1 The specimen shall consist of approximately 10 gm of the propellant prepared with minimum atmospheric exposure and placed in a suitable sealed container to reduce loss of volatiles or adsorption of moisture.

Note: If the size of the propellant as received would unnecessarily prolong the time required for extraction, the specimen may be crushed or sliced.

This procedure has been used successfully on the following single-base and multi-base propellants but is applicable to other propellant formulations:

Single-Base

M-1 SP, original size

M-1 MP, original size

M-6, crushed

Benite, original size

IMR, original size

CBI, original size

Multi-Base

M30, original size

M26, original size

M-7, original size

Rolled propellants, cut

Various casting powders, original size

Note: Original size refers to material of 0.3 inch or less in diameter.

3. APPARATUS

3.1 Gas chromatograph (GC) equipped with a thermal conductivity detector, a one-millivolt recorder and integrator.

3.2 Columns: 1/4-inch O.D., stainless steel tube containing 80–100 mesh Porapak Q and of the following lengths:

(a) eight-foot for analysis of water, ethyl alcohol and diethyl ether in single-base propellants.

(b) two-foot for analysis of water, ethyl alcohol, and acetone in multi-base propellants

3.3 Erlenmeyer flasks, 125 ml.

3.4 Rubber stoppers, size 5-1/2, solid.

3.5 Syringe, 50 microliters (μ l) or as required.

3.6 Serum bottles, 30 ml capacity.

3.7 Rubber stoppers (or seals) for serum bottles.

3.8 Pipets, 25 and 50 ml volumetric.

3.9 Shaker, horizontal (for flasks).

4. MATERIALS

4.1 Acetone.

4.2 Acetone, dried.

4.3 Methyl ethyl ketone (MEK), certified reagent grade.

4.4 Sec.-butyl alcohol.

4.5 Molecular sieves, type 4A, size 1/16" pellets (or equivalent).

4.6 Ethyl alcohol, absolute, dried.

4.7 Water, distilled.

4.8 Diethyl ether, dried.

4.9 Helium.

4.10 Extraction solution: Mixture of dry methyl ethyl ketone and dry sec.-butyl alcohol of the following ratio:

4.10.1 MEK/sec.-butyl alcohol (25/75): primarily used for the analysis of moisture, ethyl alcohol, and diethyl ether in single-base propellants containing nitrocellulose of approximately 13.15% nitrogen.

4.10.2 MEK/sec.-butyl alcohol (20/80): primarily used for the analysis of moisture, ethyl alcohol, and acetone in multi-base propellants containing nitrocellulose of approximately 12.60% nitrogen

5. PROCEDURE

5.1 Preparation of Extraction Solvents

5.1.1 Dry solvents for extraction by adding approximately a one-inch layer of molecular sieves directly to gallon containers of methyl ethyl ketone and sec.-butyl alcohol prior to mixing in the proper ratio and allow a minimum of two days for the absorption of the moisture in the solvent.

5.1.2 Mix the dry methyl ethyl ketone and dry sec.-butyl alcohol in the proper ratio by volume: 25/75 or 20/80 (or as needed).

5.1.3 Add a one-inch layer of molecular sieves to the container of mixed solvents to further dry solvent for a minimum of 2 days and to insure that the solvent remains dry. The container must be kept sealed from atmospheric moisture.

5.2 Preparation of Standard.

5.2.1 With minimum exposure to the atmosphere, pipet 25 ml of the dry extraction solvent into a 30 ml serum bottle.

5.2.2 Immediately stopper the bottle with the appropriate stopper and weigh the bottle to the nearest 0.2 mg.

5.2.3 Using a clean dry syringe, inject through the rubber stopper approximately 0.10 ml each of distilled water, dry ethyl alcohol, and dry diethyl ether or dry acetone, depending on types of process solvents used in the manufacture of the propellant. Reweigh the bottle to the nearest 0.2 mg after each injection to determine the weight of each component added. The syringe should be rinsed with acetone and dried between each injection with dry air.

Note: If necessary, the concentration of the standard may be varied depending on the sample concentration.

5.2.4 Record the weight of each component.

5.3 Testing.

5.3.1 Add approximately 10 grams of propellant, weighed to the nearest 0.2 mg, to a 125 ml Erlenmeyer flask and stopper immediately.

5.3.2 Record the sample weight.

5.3.3 Pipet 50 ml of extraction solvent into the flask and immediately stopper.

5.3.4 Place the prepared flask on a horizontal shaker at a low speed for gentle agitation at ambient conditions to extract the process solvents from the propellant. The MEK will swell the propellant to facilitate removal of process solvents.

5.3.5 Extraction times will vary with propellant type. Ten hours is usually sufficient for most single-base propellants. Multi-base propellants usually require a 16-hour extraction time.

5.3.6 Remove the flask from the shaker and allow solids to settle 15 minutes.

5.3.7 Check the gas chromatographic operating conditions, make necessary adjustments, and allow the instrument to stabilize. (See Table 1).

5.3.8 Inject 20 μ liter (or as required) of the liquid portion of the sample into the gas chromatograph.

5.3.9 Allow each component to elute from the column and measure its area with an integrator.

5.3.10 The sequence of separation of the components will be as follows:

Table 1

	Condition A	Condition B
Column	8 foot	2 foot
Oven temperature	150°C	125°C
Injection port	170°C	140°C
Detector	180°C	140°C
Bridge Current	200 ma	200 ma
Helium (carrier) flow	60 cc/min	60 cc/min
Helium Inlet Pressure	50 psig	50 psig

Condition A: For analyzing single-base propellants (no nitroglycerin) (or other nitrated esters) present for water, ethyl alcohol, and diethyl ether. See Fig 1.

Condition B: For analyzing multi-base propellants for water, ethyl alcohol, and acetone, primarily. See Fig 2.

Note: If multi-base propellants are tested using Condition A, nitroglycerin will decompose and interfere with the water peak.

Condition A: Air, water, ethyl alcohol, impurity from extraction solvent (observed when the gas chromatograph is set at high sensitivity), diethyl ether, and extraction solvent (MEK/sec.-butyl alcohol). See Fig. 1. If acetone is present, it will elute at approximately the same retention time as the impurity from the extraction solvent.

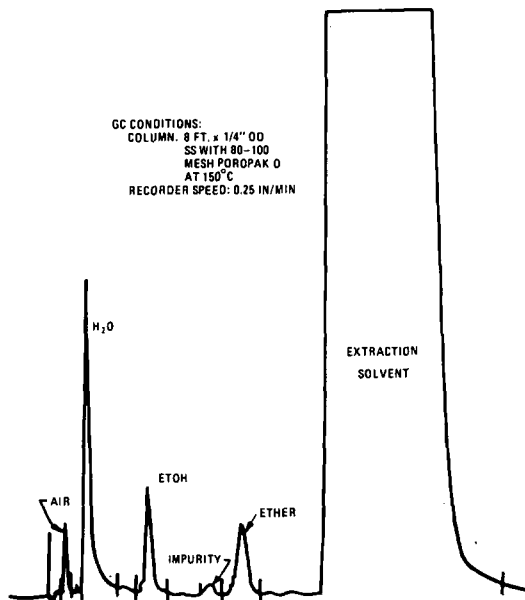

Fig 1 - Condition A, GC Scan of a Typical Single-Base Propellant Extract

Condition B: Air, water, ethyl alcohol, acetone, impurity from extraction solvent and extraction solvent (MEK/sec.-butyl alcohol). See Fig. 2. If diethyl ether is present, it will elute immediately before the extraction solvent and will be interfered with by the impurity from the extraction solvent.

Note: Acetone and diethyl ether can be analyzed quantitatively using Conditions A and B, respectively, if the area of the impurity is subtracted.

5.3.11 Repeat Paragraphs 5.3.8 through 5.3.10 using the standard.

5.3.12 Run a blank by repeating Paragraphs 5.3.8 through 5.3.10 using the MEK/sec.-butyl alcohol solution to obtain the water correction (if necessary).

5.3.13 Calculation:

$$\%H_2O = \frac{(A_1 - A_b)(W_1)(100)(E)}{(A_s - A_b)(W_2)}$$

$$\%X = \frac{(A_1)(W_1)(100)(E)}{(A_s)(W_2)}$$

% TV (total volatiles) = the sum of all process solvents [% H₂O + % alcohol + ether (or % acetone)]

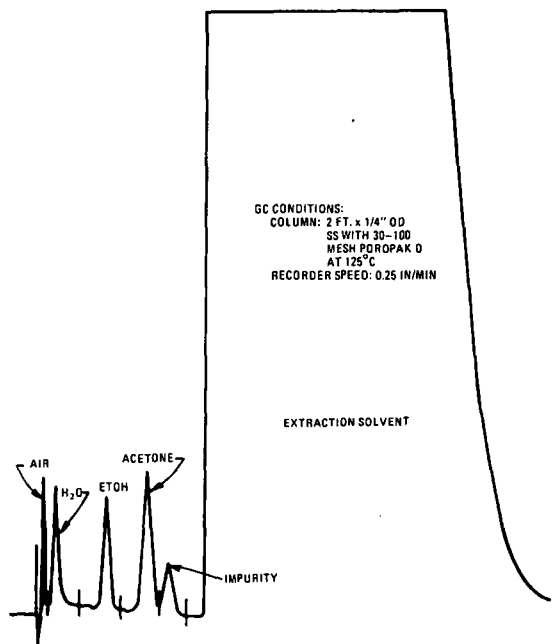

Fig 2 - Condition B, GC Scan of a Typical Multi-Base Propellant Extract

Where: X = % alcohol, ether, or acetone

A_1 = Area of peak of unknown sample.

A_s = Area of peak for standard.

A_b = Area of water peak in extraction solvent.

W_1 = Grams of component per 25 ml of standard.

W_2 = Sample weight.

E = Ratio of solvent between sample and standard (equals 2 when 50 ml is used for samples and 25 ml is used for standard).

Two tests are current in the USA for the determination of moisture and volatiles in expls. They are contained in "Military Standard-Explosive: Sampling, Inspection and Testing", MIL-STD-650 (3 Aug 1962), and are reproduced below verbatim:

Method 101.5 (3 Aug 1962)

Moisture and Volatiles (Oven Method)

1. SCOPE

1.1 This method is used for determining the moisture and volatiles of explosives on the basis of loss of weight on heating at $100^\circ \pm 5^\circ\text{C}$.

2. SPECIMEN

2.1 The specimen shall consist of approximately 5 gm of the explosive, weighed to within 0.2 mg.

3. APPARATUS

3.1 Weighing dish (aluminum or glass) diameter 60 mm, depth 30 mm

Warning: Samples that exhibit hygroscopicity require a glass receptacle with a tight fitting stopper. In the event a receptacle with a ground glass stopper is used, it should be the slip-on (cap-style) type of stopper.

3.2 Oven

3.3 Desiccator containing an indicating desiccant.

4. PROCEDURE

4.1 Place the specimen in a tared stoppered weighing dish.

4.2 Heat the dish and contents with the stopper removed for 4 hours in an oven at $100^\circ \pm 5^\circ\text{C}$ and atmospheric pressure.

4.3 Cover the dish and cool the specimen to room temperature in the desiccator.

4.4 Determine the loss in weight, and calculate (by weight) the percentage of moisture and volatiles in the sample.

4.5 Calculations

$$\text{Percent moisture and volatiles} = \frac{A}{B} \times 100$$

where: A = loss in weight, gm

B = weight of sample, gm

Method 101.6 (3 Aug 1962)

Moisture and Volatiles (Vacuum Oven Method)

1. SCOPE

1.1 This method is used for determining the moisture and volatiles, on the basis of loss of weight on heating at $55^\circ \pm 2^\circ\text{C}$. under vacuum, on multi-component explosives that contain material that would be damaged by 100°C . heat treatment at atmospheric pressure.

2. SPECIMEN

2.1 The specimen shall consist of approximately 5 gm of the explosive weighed to within 0.2 mg

3. APPARATUS

3.1 Weighing dish (aluminum or glass): diameter, 60 mm; depth, 30 mm.

3.2 Vacuum Oven

3.3 Desiccator containing an indicating desiccant.

4. PROCEDURE

4.1 Follow the procedure described in Method 101.5 for the determination of the percentage moisture and volatile in the explosive. However, in this determination heat for 6 hours in a vacuum oven at a temperature of $55^\circ \pm 2^\circ\text{C}$. and a pressure (absolute) of 80mm \pm 10mm of mercury instead of four (4) hours in an oven at $100^\circ \pm 5^\circ\text{C}$. and atmospheric pressure.

Volkman, Friedrich. Austrian inventor of smokeless powder made of colloid NC (Ref 1). Volkman found that by more or less gelatinizing the nitrated cellulose of wood granules with a solvent, such as a mixture of ether and alcohol, the speed of burning of the finished powder could be controlled within wide limits. This was an important discovery. The more of the NC that was dissolved and turned into a horny coating on the remaining NC, the slower burning the grain became in a gun chamber. The powder was partly colloid, and so was named *Colloden*. Manufacture of this successful and pioneer expl was stopped by the Austrian Govt in 1875, as it was held to constitute a threat to their powder making monopoly (Ref 3). Volkman never got anything for his invention, and it is unknown what became of him

Volkman's patents of 1870 and 1871 clearly outlined the principles of smokeless powder manufacture by gelatinization and described the properties which present NC powders have. If the Austrian War Dept had but paid more attention to Volkman and perfected the methods of manufacture, Austria could have had a smokeless powder some twelve years before any other country. Their attitude was that his powder was lacking in proper qualities, was very imperfect and irregular, and therefore useless for the army (Ref 2)

However, the patent specifications speak for themselves. The powder was made from nitrated wood, then treated with a mixt of 5 p of ether and 1 p of alcohol for 30 minutes, and the resulting paste dried for 12 hrs at 19–30°. It was then pressed in special molds to obtain any desired shape, and further dried for 24 hrs at 30° and another 24 hrs at 50°. This, according to his claims, gave it the consistency of wood. By treating the nitro-lignin for a longer time with the solvent and thereby "dissolving the ligneous fibres in the interior more or less", and by varying the molding pressure, he regulated gas production of the powder mathematically

Volkman made three kinds of powder, one yellow in color in which no solvent was used; a second, brown in color, which received a solvent treatment of a few minutes only and was only superficially gelatinized; and a third, also brown, which was made compact and of any shape by longer treatment with ether-alcohol and molding

Volkman claimed the following properties for his powder vs BlkPdr:

- 1) The smoke is transparent
- 2) The noise of the detonation is much less than with BlkPdr
- 3) Only a very small residue is left in the barrel and this is removed by the succeeding shot
- 4) Only half the quantity of powder is required to carry the projectile one-third farther with a velocity one-fourth greater
- 5) The trajectory is flatter by one-half
- 6) The effect of the powder is constant
- 7) There is no danger in its manufacture
- 8) There is no danger in storing it, as it explodes only if confined. Otherwise it only burns with a clear flame
- 9) There is no danger in its transportation
- 10) It is not injured by humidity. If it is accidentally wetted, it needs only to be dried to make it fit for use

For his partly and completely gelatinized powders (types 2 and 3) he claimed further that the volume was reduced, that they were not hygroscopic at all, and that they had in a small volume as great a power as any known explosive. This might have been written of modern smokeless powders, except that NC powders are somewhat hygroscopic and their power is impaired by exposure to humid conditions (Ref 2)

Refs: 1) F. Volkman, AustrianP 21-208 (1870) & AustrianP 21-257 (1871) 2) VanGelder & Schlatter (1927), 775–78 3) E. Bryan, "Cornish Explosives", The Trevithick Society, Cornwall, Engl (1978), 155

Volksgewehr. Ger automatic rifle. In 1944 the Ger Govt called upon various arms manufacturers to develop *Primitif-Waffen*, cheap and expendable weapons which could be quickly produced and issued to the Volkssturm (home guard) units being formed for the last-ditch defense of Germany. The Gustloff Co of Suhl were given the task of developing an automatic rifle

The weapon which they produced was based on a 1943 design by Barnetske, their chief engineer, and it consisted of a rifle barrel surrounded by a tubular sleeve which carried the bolt at its rear end. This was carried in a casing in which the boltsleeve unit could recoil against a spring and in which was the trigger and firing

mechanism. The tubular sleeve maintained an annular space around the barrel; in this space was the recoil spring and, just behind the muzzle, four gas ports which led from the barrel into the annular space. On firing, some of the propelling gas passed thru these vents and acted on the forward end of the sleeve, resisting the rearward force being generated at the other end of the sleeve by the cartridge case forcing back the bolt. The balance of these two forces gave a delayed action to what would otherwise have been a simple blowback weapon. Feed was by a 30-round box magazine, that of the Stug 44 assault rifle, and it was chambered for the short 7.92mm (0.312") M1943 cartridge. Its weight is 4.52 kgs (10 lbs, 2 oz); length 885mm (34.8"); barrel length 378mm (14.9"); and muzzle velocity 655m/sec (2150ft/sec)

Although the weapon appears cheap and shoddy, it is well built where it matters and there was an ample safety factor. The only defects were the probability of fouling building up inside the sleeve, and the possibility of barrel expansion due to heat causing the sleeve to bind or jam. WWII ended before much production could take place, but quite a number were made and many survive today

Ref: B. Fitzsimons, Ed, "The Illustrated Encyclopedia of 20th Century Weapons and Warfare", Vol 24, Purnell Reference Books, Milwaukee (1979), 2580

Volkspistole. Ger automatic pistol. This was another development due to the *Primitif-Waffen* (see above) program. It was developed early in 1945 for arming the Volkssturm, but got no further than the prototype model. Due to the fragmentary record-keeping in Germany in early 1945, the actual makers of this pistol are not known. The Volkspistole uses a similar system of delayed blowback to that of the Volksgewehr (see above). The barrel is fixed to the frame and surrounded by a slide which forms an annular chamber around the barrel. Vents lead into this from the gun barrel so that high-pressure gas will serve to hold the slide, and thus the breech, from moving back for a short time after firing. The barrel is extended by a smoothbore tube; the purpose of this has never been officially explained, but it is possible that it would sustain

chamber pressure so as to improve the delayed blowback action. The pistol is chambered for the standard 9mm (0.354") Parabellum cartridge and uses a Walther 8-round P-38 magazine. Its estimated muzzle velocity is 380m/sec (1250 ft/sec)

Ref: B. Fitzsimons, Ed, "The Illustrated Encyclopedia of 20th Century Weapons and Warfare", Vol 24, Purnell Reference Books, Milwaukee (1979), 2580

Volney, Carl Walter. Ger chemist who was associated with a number of NG Dynamite and smokeless powder manufg ventures in the USA over a forty-year period during the late 19th and early 20th centuries. Among his many inventions was a progressive burning smokeless powder in which the inside of the grain consisted of high nitrogen NC, with the outer portion contg lower nitrogen NC. This was achieved by treating the surface of the grains with reducing agents such as alkaline sulfides or sulfites (USP 592485 of 1897)

Volney patented in 1874 an expl intended for use in torpedoes contg Mononitronaphthalene 20.8, K nitrate 68.6 and S 10.6%. Another patent (1897) for cannon smokeless powder described the mixing of 86.00 p of dodecanitrocellulose with 7.82 p of rosaniline or its homologues and 6.18 p of benzene, all dissolved in acetone. According to Ref 3, the production of Nitro-starch started in the USA in about 1888, under the name "Volney's Powder"

Refs: 1) Daniel (1902), 788 2) VanGelder & Schlatter (1927), 352, 378, 394, 586, 637, 660, 671, 676, 781, 796, 867-68, 871 & 874 3) Urbanski 2 (1965), 419

Volpert. Patented in Ger in 1896, a mining expl contg K nitrate 40, NG 30, Mg sulfate cryst 24, turpentine 4, collodion cotton 1 and soda ash 1 p. Volpert also patented in 1897 in both Belg and Engl, AN based mining expls with the following typical formulation: AN 82.5, K pyrosulfate 7.5, naphthalene 5.0 and K ferrocyanide 5.0 p

Refs: 1) Daniel (1902), 789 2) B.T. Fedoroff et al, "Dictionary of Explosives, Ammunition and Weapons (German Section)", PATR 2510 (1958), 216

Not done

Volume, Specific

Introduction

Specific volume, usually designated by v , is the volume of a unit weight of material. Thus in cgs units v is in cm^3/g , and in mks units it is m^3/kg . Of course, $v = 1/\rho$ where ρ is the density of the material. This article is concerned with the *specific volume of products* of steady detonation of condensed expls. One further restriction is that these products are at the CJ state, ie, at the equilibrium state attained upon completion of the detonation reaction. Because of product expansion and rarefaction waves, this state of immense pressures and high temps is very short-lived. Consequently it is intuitively obvious that direct measurements of v_1 , the specific volume of materials at the CJ state, is virtually impossible. To date no such direct measurements are available, and v_1 must be obtained from indirect measurements or else computed theoretically

We will now proceed to describe theoretical computations of v_1 , followed by semi-empirical calcns based on exptl data

Theoretical computations of v_1

From the conservation equations for a shock wave (see Vol 7, H179-L) one obtains:

$$v_s/v_0 = 1 - u/U \tag{1}$$

where v_s is the specific volume immediately behind the shock front, v_0 is the specific volume of virgin material, and u and U are respectively particle velocity (see article "Velocity, Particle", in this Vol) and shock velocity. For a detonation (considered to be a chemically supported shock):

$$v_1/v_0 = 1 - u_1/D \tag{2}$$

where v_1 is now the specific volume of the detonation products at the CJ plane, u_1 the particle velocity at the CJ plane, and D is the detonation velocity. Since v_0 is known ($v_0 = 1/\rho_0$), measurement or theoretical computation of u_1 and D will determine v_1

An alternate form of Eq (2) is:

$$p_1 = \rho_0 D^2 (1 - \rho_0 v_1) \tag{3}$$

Here p_1 is the CJ pressure. As above, measured or computed values of p_1 and D can be used in Eq (3) to obtain v_1

For a detonation whose products obey the ideal gas law (gaseous detonations or condensed phase detonations at very low ρ_0):

$$v_1 \approx \frac{\gamma_1 v_0}{\gamma_1 + 1} \tag{4}$$

where $\gamma_1 = c_p/c_v$ of the detonation products and it is assumed that $p_1 \gg p_0$. Thermochemical calcns can then be used to evaluate γ_1 and consequently v_1 . If p_0 is not negligible in comparison with p_1 , Eq (4) becomes:

$$\frac{v_0}{v_1} = \left(\frac{\gamma_1 + 1 - \frac{p_0}{p_1}}{\gamma_1} \right) \tag{5}$$

For detonation products which are polytropic (ie, $p v^\kappa = \text{const}$), γ 's of Eqns (4) and (5) are replaced by κ 's where $\kappa = (\partial \ln p / \partial \ln \rho)_s$. For dense HE's, $\kappa \approx 3$. Unfortunately, it is not possible to evaluate κ exactly solely by thermochemical calcns, unless the EOS of the detonation products is known, which, of course, it is not for dense expls

A useful semi-empirical EOS was proposed by Jones (Ref 1; also see Ref 8, Chapt 7). With this EOS, v_1 is given by

$$v_1 = \frac{1}{\rho_0} \left(1 - \frac{1}{g_0(2+\lambda)} \right) \tag{6}$$

where $g_0 = 1 + d \ln D / d \ln \rho_0 = 1 + B \rho_0 / (A + B \rho_0)$ if $D = A + B \rho_0$; where A and B are characteristic constants for a given expl, and $0 \leq \lambda \leq 0.25$ and is defined by $1/\lambda = (1/p) (\partial e / \partial v)_p$, where e is the specific internal energy

Two types of EOS in wide current use are the BKW and JCZ-3 (Refs 4, 9 & 11). Both provide means of computing v_1 though they do not give explicit analytical solutions for v_1

Kuznetsov & Svedov (Ref 6 and Vol 9, R125-126) used a Gruneisen type EOS to obtain

$$p = p_0 + \Gamma(1/v) (e - e_0 - \Delta) \tag{7}$$

where Γ is the Gruneisen coefficient of the detonation products and Δ is a complex function of the product temp (see Vol 9, R125). This eqn is also applicable to products at the CJ state and can be used to evaluate v_1

Computed values of v_1 , according to the various EOS described above, are shown in Table 1 for RDX, TNT and PETN as a function of initial

Table 1
Theoretical and Semi-Empirical Computations of v_1

Explosive	ρ_0 (g/cm ³)	v_1 (cm ³ /g)								
		Theoretical			Semi-empirical					
		JCZ-3	BKW	Kuznetsov	Cook	Jones Method (a)	Roth	Hardesty	Kamlet	Johansson
RDX	1.80	0.427	0.416	0.418	0.438 (b)	0.408	0.411	0.423	0.418	0.415
RDX	1.40	0.528	0.523	0.529	0.546	0.518	0.522	0.535	0.522	0.525
RDX	1.00	0.719	0.713	0.719	0.735 (b)	0.712	0.718	0.728	0.711	0.714
TNT	1.60	0.476	0.463	—	—	0.457	0.456	0.472	0.464	0.464
TNT	1.40	0.531	0.521	—	—	0.519	0.522	0.535	0.522	0.525
TNT	1.20	0.608	0.604	—	—	0.602	0.604	0.617	0.600	0.605
TNT	1.00	0.720	0.714	—	—	0.715	0.718	0.728	0.711	0.714
PETN	1.77	—	0.421	—	0.441 (b)	—	0.417	0.430	0.424	0.422
PETN	1.40	—	0.520	—	0.547 (b)	—	0.522	0.535	0.522	0.525
PETN	1.25	—	0.581	—	0.602 (b)	0.588 (e)	0.582	0.594	0.578	0.583
PETN	1.00	—	0.713	—	0.735 (b)	0.719 (e)	0.718	0.728	0.711	0.714
PETN	0.75	—	0.93 (f)	—	0.957 (b)	0.933 (e)	0.936	0.939	0.941	0.925
PETN	0.50	—	1.35 (f)	—	—	1.34 (e)	1.35	1.32	1.44	1.30
Refs:		9	4	2	6	1	(c)	11	(d)	7

Notes: (a) $D = 2.56 + 3.47\rho_0$; $\lambda = 0.2$ for RDX; max error due to uncertainty in $\lambda \sim \pm 2.5\%$

$D = 1.873 + 3.187\rho_0$; $\lambda = 0.15$ for TNT; max error due to uncertainty in $\lambda \sim \pm 2.5\%$

$D = 1.87 + 3.68\rho_0$; $\lambda = 0.1$ for PETN; max error due to uncertainty in $\lambda \sim \pm 2.5\%$

(b) Interpolated

(c) J. Roth, in prepn for publication

(d) Quoted in Ref 11

(e) Original Jones calcn

(f) Extrapolated

density. Also shown are semi-empirical computations which will be discussed later. Note that the BKW, Kuznetsov and Jones EOS give essentially equivalent v_1 's. The v_1 's computed via the JCZ-3 are somewhat larger and those obtained via Cook's method are larger still. Nevertheless, the maximum spread between the largest and smallest computed values is only about 5%. Thus the type of EOS used in computing v_1 makes little difference in the absolute values of v_1 . Indeed, for rough approximations of v_1 , one can use Eqn (4) (with κ_1 substituted for γ_1) and assume that $\kappa_1 = 3$, although this will result in appreciable error at low ρ_0 .

As already mentioned, thermohydrodynamics, the ideal gas law, and Eqns (2) or (4) can be used to compute v_1 for condensed expls at very low packing densities. Examples of this as computed by the writer from the results of Stesik & Shvedova (Ref 5) are shown in Table 2

Table 2
Specific Volumes of Detonation Products of Explosives at Low Density

Explosive	ρ_0 g/cm ³	v_1 cm ³ /g
NC	0.005	108.1
NC	0.01	54.3
TNT	0.01	54.8
Tetryl	0.01	55.1
PA	0.01	55.2
RDX	0.01	53.9
PETN	0.01	53.3

Note that once again the max spread in v_1 (at a given ρ_0) is only about 3% for the six expls shown in Table 2

To summarize: v_1 is primarily a function of ρ_0 and essentially independent of the chemical nature of the expl (at least for CHNO expls)

Semi-Empirical Methods

Johansson & Persson (Ref 7) obtained the following correlation: $\rho_1 = 0.14 + 1.26\rho_0$ based on analysis of Mader's computations using the BKW EOS (Ref 4) (recall that $\rho_1 = 1/v_1$). It can be seen in Table 1 that this correlation provides an excellent fit to the Mader results

Hardesty & Kennedy (Ref 11) obtained: $\rho_1 = 0.136 + 1.238\rho_0$ to fit their JCZ-3 computa-

tions. As seen in Table 1, the fit to the theoretical values is good, but not quite as good as Johansson's fit to Mader's data

Kamlet and coworkers proposed a simplified scheme for computing p_1 and D (see article on "Velocity, Detonation" in this Vol). Their results can be used to estimate v_1 as shown below. Eqn (3) can be rewritten as:

$$v_1/v_0 = 1 - p_1/\rho_0 D^2 = 1 - K^2 \rho_0^2 \phi / \rho_0 A^2 \phi (1 + B\rho_0)$$

(see "Velocity, Detonation" article for definition of terms of the right-hand Eqn). Simplifying and inserting values for the constants K and A gives:

$$v_1/v_0 = 1 - 1.529\rho_0 / (1 + 2.60\rho_0 + 1.69\rho_0^2) \quad (8)$$

Thus, v_1 is expressed entirely in terms of ρ_0 . Table 1 shows that Eqn 8 gives a good fit to the BKW results except at $\rho_0 < 1$. This is not unexpected since Kamlet "normalized" his scheme against BKW results

The writer (publication in prepn) also used Eqn 3 to obtain the following correlation:

$$\rho_1 = 0.0908 + 1.303\rho_0 \quad (9)$$

This correlation is based on the examination of *measurements* of p_1 and D at various ρ_0 values for some 60 expl- ρ_0 combinations. It does not involve choosing any particular EOS, thus avoiding the controversy among the proponents of the various types of EOS in current use. It does, however, suffer from the fact that there is considerable scatter in the published data on detonation pressures. To normalize these data, the following scheme was adopted: It can be shown that κ is independent of the choice of EOS, and using the CJ condition and defining local sound velocity as $c^2 = \kappa p / \rho$ one obtains

$$\kappa_1 = (\rho_1/\rho_0 - 1)^{-1} \quad (10)$$

As ρ_0 approaches 0, κ_1 approaches $c_p/c_v = \gamma_1$, thus there is an "anchor point" for the κ_1 vs ρ_0 curve. Now with the reasonable assumption that this curve is monotonic and approaches an asymptote at large values of ρ_0 (or at least a very slow increase in κ_1 with large increases in ρ_0) one can choose only those values of p_1 that give values of κ_1 (via Eqns 9 & 10) that lie close to a monotonic κ vs ρ_0 curve which passes thru γ_1 as ρ_0 approaches 0

Examination of Eqn (9) (or Eqn (8), or the Johansson or Hardesty empirical fits) reveals

Table 3
Application of Jones' Method (Eqs 6 & 10) to Low Density Explosives

HE	ρ_0 g/cc	g_0	λ	γ_1
TNT	0.01	1.017 (a)	0	1.03
TNT	0.01	1.017	0.25	1.29
PETN	0.01	1.011 (b)	0	1.02
PETN	0.01	1.011	0.25	1.27
RDX	0.01	1.004 (c)	0	1.01
RDX	0.01	1.004	0.25	1.26
NC	0.01	1.008 (d)	0	1.02
NC	0.01	1.008	0.25	1.27

Notes: (a) $D = 1.873 + 3.187\rho_0$
(c) $D = 1.81 + 4.22\rho_0$

(b) $D = 2.50 + 2.86\rho_0$
(d) $D = 2.10 + 2.55\rho_0$

that all these correlations break down as ρ_0 approaches 0. For example, at $\rho_0 = 0.01$ g/cc, Eqn (9) yields $\rho_1/\rho_0 \sim 10.39$, which is much too large. Most of the theoretical computations for ρ_1 (or v_1) also break down as ρ_0 approaches 0, as shown by the following. The BKW EOS computation for $\rho_0 \geq 1$ g/cc gives $v_1 = 0.7145\rho_0^{-0.9253}$ with a correlation factor of -0.9998 (a correlation factor of ± 1 shows perfect correlation) for 51 expl- ρ_0 combinations. This expression (if it is assumed to hold for $0 < \rho_0 < 1$), coupled with Eqn (10) gives $\gamma_1 = 1.03$ at $\rho_0 = 0.01$ g/cc. Such a low value of γ_1 is unreasonable. The data in Table 2 give $1.14 \leq \gamma_1 \leq 1.23$ at $\rho_0 = 0.01$ g/cc. Similarly the correlation for JCZ-3 computation is $v_1 = 0.721\rho_0^{-0.8930}$ with a correlation factor of -0.9995 for 13 expl- ρ_0 combinations. This correlation gives $\gamma_1 = 0.79$ at $\rho_0 = 0.01$ g/cc. A value of $\gamma < 1$ is utterly impossible! The EOS that leads to reasonable values of γ_1 as ρ_0 approaches 0 is that of Jones (Eqn (6)). As shown in Table 3, the γ_1 's obtained with Eqs (6) and (10) are *entirely reasonable* for $0 < \lambda \leq 0.25$, which is the λ range proposed by Jones on the basis of thermodynamic considerations

Applications of v_1

Probably the most useful application of v_1 is an *inverse* approach of estimating p_1 . It has been shown that the relation between ρ_1 (or v_1) and ρ_0 is not dependent on the chemical nature of

the expl (see Table 1). Consequently v_1 estimated from either theoretically-based or empirically-based correlations can be used in Eqn (3) to obtain p_1 . This approach is particularly useful in estimating p_1 for industrial expls, for which D is generally known, but p_1 is rarely measured. The writer used this scheme for estimating p_1 for a variety of industrial expls (Ref 12)

If it is assumed that the κ vs ρ_0 curve is monotonic, then κ 's obtained via Eqn (10) based on theoretically computed ρ 's can be compared with κ 's derived from exptl measurements of p_1 and D . Agreement between theoretical and exptl κ 's can provide justification for choosing a particular EOS. Unfortunately, as already mentioned, there is considerable scatter in the "experimental" κ 's. Preliminary comparisons suggest that κ 's obtained from BKW calcs are in reasonable accord with "experimental" κ 's for $\rho_0 > 1$ g/cc. Agreement between theoretical and exptl κ 's for the JCZ-3 EOS is poorer over the entire ρ_0 range. The Jones method gives good agreement at low ρ_0 and reasonable agreement over the entire ρ_0 range

Braco (Ref 10) derived a "general" relationship which he claims must be satisfied by any thermal EOS for detonation products. He concludes that knowledge of v_1 , D and u_1 as a function of loading density is *insufficient* to determine the thermal EOS. This conclusion, borne out by experience (different EOS give similar values of D , v_1 and u_1 , but very different values of T_1) is somewhat weakened by several

erroneous assumptions in attaining it. However, Braco is certainly correct in pointing out the desirability of obtaining exptl information for $T_1 = T(v_0)$ in order to develop a satisfactory thermal EOS

Written by J. ROTH

Refs: 1) H. Jones, 3rd Combustn Symp (1949), 590 2) Cook (1958), 298 3) A.N. Dremen et al, 8th Combustn Symp (1962) 4) C.L. Mader, LA 2900, Los Alamos Natl Scientific Lab, NM (1963) 5) L.N. Stesik & N.S. Shvedova, JApplMekh&TechnFiz 4, 124 (1964) 6) N.M. Kuznetsov & K.K. Shvedov, FizGorVzryva 5, 362 (1969) 7) C.H. Johansson & P.A. Persson, "Detonics of High Explosives", Academic Press, NY (1970), 34 8) Anon, EngrgDesHndbk, "Principles of Explosive Behavior", AMCP 706-180 (1972) 9) M. Cowperthwaite & W.H. Zwisler, Final Rept, SRI Proj PYU-1397, Stanford Res Inst, Ca (1973) 10) F.V. Braco, Combustn&Flame 22, 9 (1974) 11) D.R. Hardesty & J.E. Kennedy, Ibid 28, 45 (1977) 12) J. Roth, Proc APS Symp on Shock Waves in Condensed Matter (1981), in press

Volume Strength. See under "Strength of Explosives" in Vol 9, S219-R

Volumex. Trade name of a semigelatinous, porous, low density expl distributed in Switzerland by Vereinigung Schweizerischer Sprengstoff-Fabriken, designed for "smooth blasting" operations. Its d is 0.6g/cc with a weight strength of 85%

Note: The purpose of *smooth* or controlled blasting is to produce an excavation contour, while leaving behind an intact, fissure-free formation. This is done by the use of diminished-strength expl charges, using numerous boreholes, driven exactly in parallel

Ref: R. Meyer, "Explosives", Verlag Chemie, NY (1977), 239 & 314

Von Brank's Powder. See under "Brank's Powders" in Vol 2, B261-L

Von Dahmen Explosives. See under Dahmen, Johann, von" and "Dahmenit A" in Vol 3, D1-R

Von Geldern, Egmont. In 1899 patented expl compns contg naturally carbonized cellulose, such as peat, dead tree leaves, etc, with Amm nitrate and other ingredients. One expl of this type contained partially carbonized wood and was called "Dynammon" (see Vol 5, D1742-R)
Ref: Daniel (1902), 231 & 793-94

Vonges, Dynamites de. In the latter part of the 19th century in France, in addition to *guhr* Dynamites, Dynamites were also made from a mineral called *randanite*, composed of weathered feldspar, with or without the addition of absorbent silica either from natural sources or manufd by passing Si fluoride into water. The Govt factory at Vonges, for example, made the following grades:

	No 1	No 2	No.3	Special
NG, %	75	50	30	90
Randanite, %	20.8	—	—	1
Silica, %	3.8	48	65	8
Mg carbonate, %	0.4	—	—	1
Ca carbonate, %	—	1.5	1	—
Ochre, %	—	0.5	5	—
Slag, %	—	—	4	—

Refs: 1) Daniel (1902), 794 2) E. de Barry Barnett, "Explosives", D. Van Nostrand Co, NY (1919), 96

Von Stubenrauch's Explosives. See under "Stubenrauch's Explosives" in Vol 9, S223-L

Vorlage. Ger WWI antflash bag, literally, "something put before". It consisted of doughnut shaped cotton or artificial silk cloth bags filled with coarsely pulverized K chloride. Two such bags were loaded at the base of projectiles, between the projectiles and the propelling charges

In firing with Vorlage there were produced at the muzzle a red light (glow) and a red smoke. The light gave no reflection in the sky but was visible if the piece was placed in such a way that the enemy could see its muzzle. In the daytime, the Vorlage was used only when the weather was so dark that the flashes of the gun without Vorlage were more visible than the clouds of reddish smoke produced by the Vorlage

Ref: T.L. Davis, "The Chemistry of Powder and Explosives", J. Wiley & Sons, NY (1943), 324-25

Vortices, Explosive Powered. During WWII in Ger, a Dr Zippermeyer, working at the Speer Ministry's Research Establishment near Lofer, attempted to duplicate in miniature the effects of tornadoes using expl powered vortices. Although man-made vortices had heretofore been produced using compressed air, Zippermeyer proposed to power the vortex in an entirely new way. He proposed to shoot powdered coal in a projectile. In the center of the mass of powdered coal, he placed a charge of low expl, so that, upon initiation, the coal dust would have a forward component of velocity due to the motion of translation of the projectile and a lateral

component of velocity due to the expln. A brisant expl would impart too much lateral velocity and scatter the coal dust too widely. Zippermeyer used *noodle powder*, a finely grained, rough-surfaced, double-base powder, for the expl charge. As the diffused coal powder mixes with the air in the presence of the expl charge which acts as an igniter, a coal-dust expln results. Of course, an appropriate pressure condition must exist for the coal-dust expln. Zippermeyer stated that he was unable to achieve the vortex condition unless the projectile had a velocity of several hundred meters per second. In his expts, he shot the projectile from a mortar tube which was buried in the ground. High speed movies indicated that he achieved a considerable vortex effect

Since airplanes are not built to withstand great wing loads, a very low pressure would remove the wings if it persisted for a tenth, or a few tenths of a second. Although the pressure of the vortex falls off as a function of distance, it appeared that a destructive pressure could be sustained for several hundred feet by a projectile of moderate diameter

Ref: L. E. Simon, "German Research in World War II", J. Wiley & Sons, NY (1947), 183-84

Voswinkel. In 1893 he patented (GerP 1993) the following prepn of NC: To a mixt consisting of Zn chloride 10 p, acetic acid or acetic anhydride 10 p, and fuming nitric acid 10 p, cooled to about 10°, is added gradually 1 p of cellulose. After maintaining the mixt at 10-15° for three to four days, the gelatinized mass is sepd from the acid and washed thoroughly several times with water

The same inventor patented (GerP 2007 of 1893) the following prepn of "α-trinitrophenol-dinitroglycerine" and "dinitronaphthol-dinitroglycerin": One dissolves 20 p of dinitro-α-chlorhydrin in 60 p of alcohol, and the soln is mixed with 27 p of K picrate. After heating at 70-80° until the pptn of K chloride ceases, the soln is concd and then cooled to achieve crystn
Ref: Daniel (1902), 796

V (Poudre). Original nomenclature (*Poudre Vieille*) for Poudre B, invented by P. Vieille in

1884. See under "Vieille, Paul (1854-1934)" in this Vol, and "B (Poudre)" in Vol 2, B1-L to B2-L

Vril Explosives. K chlorate based mining expls patented in Engl in 1889 having the following formulations:

	No 1	No 2
K chlorate, %	50.00	48.00
K nitrate, %	25.00	24.30
K ferrocyanide, %	4.50	9.10
Willow charcoal, %	10.50	11.60
K ferrate, %	2.00	-
Fe oxide, %	2.00	0.50
Paraffin, %	6.00	6.50

The K ferrate ingredient was prepd by passing chlorine gas thru a concd soln of K hydroxide contg Fe hydroxide in suspension

See also under "Chlorate Explosives" in Vol 2, C202-L ff

Refs: 1) Cundill (1899) in MP 6 (1893), 113
2) Daniel (1902), 797 3) Gody (1907), 264
4) Escales, Chloratspr (1910), 81 5) Guia, Trattato 6 (1959), 395

VT Fuzes. See under "Proximity or VT (Variable Time) Artillery Fuzes" in Vol 4, D918-R to D921-R; "Bomb Proximity or VT (Variable Time) Fuzes" in Vol 4, D995-R to D998-R; and "Fuzes" in Vol 6, F255-L to F257-L

Addnl Refs: 1) Anon, EngrgDesHndbk, "Fuzes, Proximity, Electrical, Part One (U)", **DARCOM-P-706-211(C)** (no date) [Introduces the various types of electrical fuzes and presents basic philosophies involved in fuze design]

2) Anon, EngrgDesHndbk, "Fuzes, Proximity, Electrical, Part Two (U)", **DARCOM-P-706-212(S)** (no date) [Discusses basic principles and design considerations for radio proximity fuzes operated in the VHF and UHF bands]

3) Anon, EngrgDesHndbk, "Fuzes, Proximity, Electrical, Part Three (U)", **DARCOM-P-706-213(S)** (no date) [Describes various types of radio proximity fuzes that operate at microwave frequencies]

4) Anon, EngrgDesHndbk, "Fuzes, Proximity, Electrical, Part Four (U)", **DARCOM-P-706-214(S)** (no date) [Discusses

various types of nonradio fuzing systems and describes the use of multiple fuzing methods]

5) Anon, *EngrgDesHndbk*, "Fuzes, Proximity, Electrical, Part Five (U)", **DARCOM-P-706-215(C)** (no date) [Discusses fuze testing and various types of power sources used in the design of safing and arming devices]

6) R.B. Baldwin, "The Deadly Fuze—The Secret Weapon of World War II", Presidio Press, San Rafael, Ca (1980) [History of development of the VT fuze during WWII]

Vukolov, S. P. (1863–1940). Russ expls chemist, pupil of and collaborator with Mendeleev in the development of "pyrocollodion" smokeless powder (see under "Mendeleev, Dmitry I." in Vol 8, M58-L). Inventor of a solventless propellant called *Stonit*. Vukolov worked for many years as an expls specialist for the Russ navy, and was a professor at the Naval Academy. He was the author of numerous publications on expls and ammo

Ref: L.I. Bagal, *JApplChem* **14**, 517–20 (1940)

Vulcain Dynamite. One of the varieties of so-called "lignin dynamites". It contained NG, lignin (such as sawdust) and Na nitrate

Ref: Daniel (1902), 408 & 797

Vulcaine. Mining expl patented in Fr in 1893 by Mourette contg K nitrate 64.0, S 25.0, charcoal 5.0, ashes 5.5 and K chlorate 0.5%

Ref: Daniel (1902), 797

Vulcan. US anti-aircraft weapon system based on the Vulcan 20 mm six-barrel gun. The gun was originally designed for aircraft use but has lent itself readily to integration in a sophisticated light anti-aircraft system

For different operational purposes the weapon system can be made available on a variety of platforms — as a towed trailer, on a self-propelled land vehicle, or mounted permanently on a ship or in a static air defense gun emplacement. The main functional units are the same in each case, however, and the description that follows relates to the towed trailer version of the system

The system comprises the Vulcan gun, a linked ammo feed sub-system, and a fire control sub-system, all mounted in an electrically-powered turret. The fire control sub-system consists of a range-only radar and a lead-computing gunsight with its associated current generator. The towed VADS (Vulcan Air Defense System) contains its own batteries and is equipped with a galoline-driven generator for recharging, and the entire system is mounted on a gun carriage

The Vulcan gun, previously used as aircraft armament at rates as high as 6000 rds/minute, has been modified for the air defense application to provide alternative firing rates of 1000 and 3000 rds/minute. Because of the weapon's six-barrel design, its dispersion pattern can be optimized by a suitable choice of muzzle adapter. The adapter chosen causes the pattern to be spread, which results in a higher hit probability

In the towed system a conventional belt feed is used for ammo, the belted rounds being fed from a 500-round container. In other systems where more space is available, a linkless feed system can be used and this has a capacity of 1100 rounds

The fire control system consists of an SM-61 gyro lead-computing gunsight and a sight current generator. The gunner visually acquires and tracks the target with the gyro lead-computing gunsight. The antenna axis of the radar is servoed to the optical line-of-sight and the radar supplies target range and range-rate data to the sight current generator. These inputs are then processed to provide outputs that are used to control the gunsight

With inputs of range, range rate, and angular tracking of the optical lines-of-sight (measured by a freely gimballed gyro), the sight automatically computes the future target position and adds the required super-elevation to hit the target

Turret fire control is a disturbed line-of-sight system. The sight case and gun bore are physically fixed in alignment, but the sight reticle, which defines the optical line-of-sight, is positioned by the gyro and is displaced from the gun bore as the gunner tracks the target, thereby establishing the proper lead angle. The amount of optical line-of-sight displacement is dependent on the range and range rate inputs to the sight, and the required tracking time to establish the

lead angle is about one second

The range-only-radar, developed by the Lockheed Co, is a coherent doppler, moving target indicator (MTI) radar. It will acquire targets upto 5000m away. A green light appears in the sight optics signalling that the radar has acquired the target and that the target is within the effective range of the turret system, so that the gunner simply acquires the target in the sight reticle, tracks the target, and fires after the green light appears (Refs 1 & 2)

One of the most recent applications of the VADS is in the US Navy's *Phalanx* ship-board antimissile system. Nine hundred-fifty discarding sabot depleted uranium rounds are carried in the feed system, and search and tracking radar are carried in a dome above the mounting. The gun is controlled automatically by the ship's fire-control computer, and a closed-loop spotting system measures the positions of target and projectile simultaneously to direct the stream of fire (at 3000 rds/minute) on to the target thruout the engagement (Ref 3)

Refs: 1) R.T. Pretty, Ed, "Jane's Weapon Systems, 1979-1980", 10th Ed, Franklin Watts, NY (1979), 85-86 2) J. Weeks, Ed, "Jane's Infantry Weapons, 1979-1980", 5th Ed, Franklin Watts, NY (1979), 487-88 3) B. Fitzsimons, Ed, "The Illustrated Encyclopedia of 20th Century Weapons and Warfare", Vol 24, Purnell Reference Books, Milwaukee (1979), 2582

Vulcania DB and DBS. See as "Tutamite" under "Italian Explosives and Related Items" in Vol 7, I181-L

Vulcanienne (Poudre). Same as Espir Powder in Vol 5, E127-L

Vulcanite. A mining expl patented near the end of the last century by Moritz and Köppel of Austria. Two variations are given:

	No 1	No 2
K nitrate, %	35.00	33.00
Na nitrate, %	19.00	22.00
Sulfur, purified, %	11.00	12.50
K chlorate, %	9.50	-
Sawdust, %	9.50	19.00
Charcoal, %	6.00	7.00
Na sulfate, %	4.25	5.00
Sugar, refined, %	2.25	-
Picric Acid, %	1.25	1.50
K ferrocyanide, %	2.25	0.00

See also as "Vulcanite P" and "Vulcanite PR" under "Italian Explosives and Related Items" in Vol 7, I182-L

Refs: 1) Cundill (1899) in MP 6 (1893), 114
2) Daniel (1902), 798 3) Guia, Trattato 6 (1) (1959), 387

Vulcan Dynamite. Nineteenth century formulation patented in the USA by Warren contg NG 30.0, Na nitrate 52.5, S 7.0 and charcoal 10.5%. About 5 tons of this expl were used in the first blasting operations to remove rocks at Hells Gate, NY in 1869

Refs: 1) Daniel (1902), 797-98 2) Barnett (1919), 98 3) Naoúm, NG (1928), 284
4) Giua, Trattato 6 (1) (1959), 388 5) C. Belgrano, "Gli Esplosivi", 2nd Ed, Arti Grafiche Fiulane, Udine, Italy (1974), 339

Vulnerability of a Target. The effect of damage on the target from a given threat or group of threats. Thus, a measure of the vulnerability of a target to a given threat is a measure of the adverse response of the target to damage to components of the target. This adverse response involves a loss (generally major) of performance capability and is related to the target kill categories. For example, vulnerability of an aircraft target may be reflected in terms of catastrophic disintegration of the airframe due to an expln, loss of flight control due to mechanical damage to control components or disabled crew members, loss of power due to failure of a damaged engine, or loss of armament control due to damage to components of this system

The determination or estimation of the vulnerability of military targets to the effects of

weapons is a very complex process. It involves careful consideration of the characteristics and geometry of a wide variety of targets, possible damaging mechanisms of an equally wide variety of ordnance and weapons; experimental and analytical terminal ballistic effects; synthesis of these elements into rational computer models, equations, or graphs; and development of efficient computer programs for estimating vulnerability of specific targets to specific types of ordnance. The cycle is not complete until the computer program or other method is tested against realistic experimental data

Systems Analysis

Target vulnerability analysis is one element in a much more comprehensive analysis which should be conducted when evaluating the effectiveness of munitions or effectiveness of methods of vulnerability reduction. The more comprehensive analysis can be termed "system analysis". System analysis applied to munitions effectiveness should help answer one or more of the following questions:

- 1) Are different munitions equally effective for the same missions?
- 2) Are new developments required to overcome existing gaps in munition effectiveness?
- 3) Should some weapons or munitions be replaced because others are more effective?
- 4) Which weapons are most effective for a broad spectrum of military targets?
- 5) How many sorties, salvos, volleys, or rounds are needed to defeat a particular target?
- 6) How can gun crews be trained to enhance the battlefield effectiveness of their weapons?
- 7) What level of munition stockpiling is appropriate to achieve realistic effectiveness?
- 8) How can the vulnerability of the US equipment be reduced?

Obviously, different system analyses must be applied, or the predictions from the analyses viewed in different ways, to help answer all of the foregoing questions. An analysis which determines which weapons are most effective for a spectrum of military targets probably will have little bearing on how to train gun crews to enhance battlefield effectiveness. Similarly, it is very unlikely that an analysis designed to determine how many rounds are needed to defeat a specific target will answer directly the questions

involved in improving survivability of a variety of US equipment by the use of vulnerability reduction techniques

System analysis for munition effectiveness, or for vulnerability reduction of our own equipment, is a complicated task. On the battlefield, weapons are not operated by experts methodically following test plans. They are operated by individuals and crews functioning under the stresses of combat against a live and reacting enemy. Data for evaluating weapons should represent the actual performance of both man and machine in combat. Only a relatively small amount of this type of information can be recovered from combat experience. Other data can be gathered from test firings if the tests are controlled carefully to allow for or simulate the realities of combat. Usually, combat or simulated combat data are simply not available, and inputs to the system analysis must be based on ballistic and vulnerability data or theories, or (hopefully) wise guesses

Typical of the complicating factors that must be considered fully if battlefield effectiveness of munitions is to be determined realistically are:

- 1) Vulnerability—a quantitative measure of the susceptibility of target or material to a given damage mechanism
- 2) Vulnerability reduction—the application of design techniques to materiel items to reduce or eliminate the effects of combat damage
- 3) Weapon characteristics—nature of the functioning of specific weapons and their damage mechanisms
- 4) Delivery accuracy—capability of a system to deliver a warhead on or near a target
- 5) Enemy actions—effect of enemy actions and countermeasures and tactics

It is difficult to incorporate all the factors required to predict the outcome of the use of a weapon in combat. Some occasionally are not recognized or are disregarded—and the result is an inaccurate estimate. Valid evaluations will consider all significant factors

One of the widest applications of system analysis in this field has been to provide procedures for selecting the proper weapon and munition for a given target or target complex. A typical procedure is shown in Fig 1. Each target is analyzed to define its vital components, and a preliminary selection is made of weapons

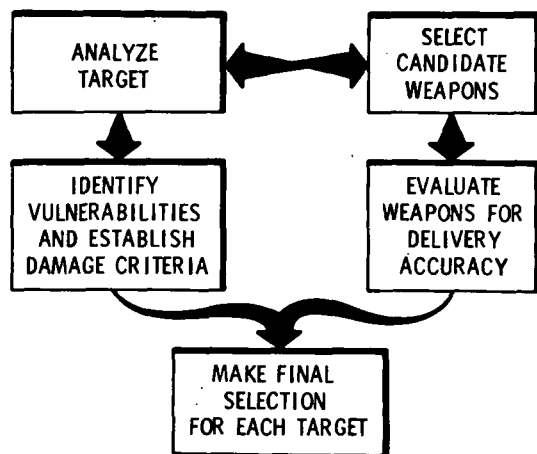

Fig 1 Structure of System Analysis for Munition Effectiveness

capable of achieving the desired damage. Each target is studied in considerable detail to identify its vulnerabilities and to establish damage criteria. Each of the candidate weapons is evaluated for delivery accuracy, hopefully under realistic combat conditions. The predicted delivery accuracies are then married with the target vulnerability data in the analysis to provide relative measure of effectiveness for each system. These measures of effectiveness then allow a final selection of weapons and munitions for each target

This brief discussion of system analysis is included here to show that target vulnerability analysis is only one element of a much more comprehensive analysis. It should *not* be considered a complete review of system analysis applied to studies of munition effectiveness

Role of Target Vulnerability Analysis

Target vulnerability analysis has a role in the assessment or estimation of munition effectiveness which can be illustrated by indicating how target vulnerability analysis enters the broader role of system analysis. The reader is referred back to the 8 questions posed above under *Systems Analysis*. Target vulnerability analysis will provide the essential input information needed to answer these questions. The answer to Question 8 is important because survivability of our own equipment can probably best be improved by identifying those components of any military target which contribute most to

the target vulnerability. Target vulnerability analysis should have considerable effect in systems analyses directed in answering Questions 2, 3 and 7, but is probably not as crucial as the answers to the other questions. Only Question 6 seems to be independent of considerations of target vulnerability

Referring again to the discussion of system analysis for munition effectiveness given above, note that the structure of system analysis in Fig 1 is heavily dependent on analysis of target vulnerability. The boxes "Analyze Target" and "Identify Vulnerabilities and Establish Damage Criteria" fall entirely within the purview of target vulnerability analysis. The process of final selection for each target involves a marriage of weapon capabilities and target vulnerability, and is therefore heavily dependent on analysis of the latter

This brief discussion highlights the role of target vulnerability analysis in the larger and more complex process of system analysis related to munition effectiveness or improvement in survivability of our own equipment. But, although target vulnerability analysis is only an element in the more complex scheme of things, it in itself is quite complex and must in turn assume or accept inputs from other sophisticated disciplines such as terminal ballistics and mathematical theory of statistics. The structure of target vulnerability analysis therefore is discussed next

Major Elements of Target Vulnerability Analysis

Target vulnerability analysis is a complex process, with many possible iterations or interactions between steps in or elements of the process. One possible division between major elements of such analysis and some interactions are shown schematically in Fig 2

One major element is the definition of damage threats from various weapons or munitions and the description of basic damage mechanism or mechanisms associated with this threat. Targets can be described somewhat independently of the consideration of threats and damage mechanisms, but often the damage mechanisms are more or less specific for certain classes of targets; a one-way interaction between these two basic elements therefore is shown in Fig 2. A careful description of targets and a function analysis

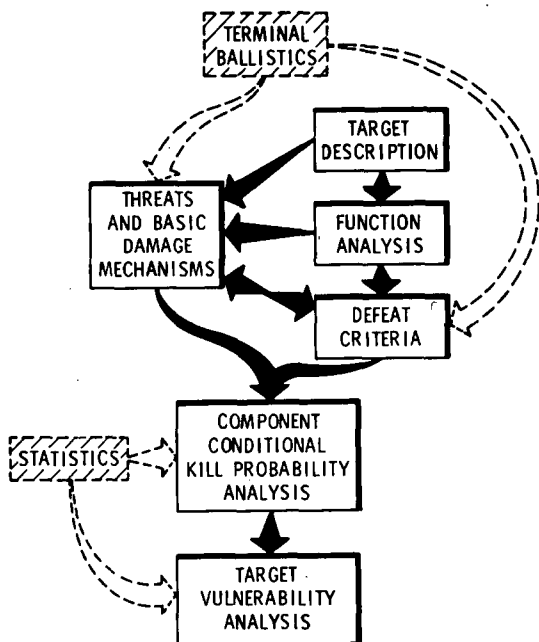

Fig 2 Elements of Target Vulnerability Analysis

lead to a definition of defeat criteria for those targets, another major element in target vulnerability analysis. The word "defeat" has a very broad context and must be related intimately to the target and the intended function of the target. This element in the analysis cannot be performed without considerable interaction between it and threats and damage mechanisms

The definitions of threats and of defeat criteria for targets are combined mathematically in the next step in the process, ie, computation of component conditional kill probability. Essentially, the target is dissected and vulnerability of its individual components analyzed. Again, the word "kill" has a very broad general connotation, but is given specific meaning in developing defeat criteria

The final step in the process is the synthesis of estimates of vulnerability of the entire target to the specific assumed threat or threats. The dissected bits of the target, whose individual probabilities of kill are now estimated from the previous step, now are reassembled conceptually as a whole to provide estimates of overall target vulnerability

Although they are not directly a part of target vulnerability analysis, two other scientific disciplines provide indispensable inputs. These

disciplines, shown in shaded boxes in Fig 2, are terminal ballistics and statistics. Threats and basic damage mechanisms for munitions cannot be estimated rationally without a thorough knowledge of terminal ballistics, which provides most of the information regarding levels of damage to targets which result in their defeat. Without proven methods from mathematical statistics, no rational techniques could have been developed for estimating conditional kill probabilities or for completing an analysis of vulnerability of an entire target complex

Since it is beyond the scope of this article to treat the subject of target vulnerability in any detail, the interested reader (with proper security clearance) is recommended to Ref 3. This handbook as a whole does not consider chemical, biological or nuclear weapons. It is intentionally limited to kinetic energy or explosive energy type weapons. A synopsis of the contents by chapter follows:

1) Chapter 1 provides a brief overview of target vulnerability methodology and its place in system analysis

2) Chapter 2 covers threats and basic damage mechanisms associated with a wide variety of nonnuclear weapons and munitions. It also touches on terminal ballistics, but does not cover this extensive topic in detail

3) Chapter 3 presents methods of describing targets for vulnerability analysis and again covers a wide spectrum of military targets. A number of computer programs for target description are discussed

4) Chapter 4 presents methods of establishing defeat criteria for many targets and gives a correlation of these criteria with target function or use. Commonly used damage assessment methods are reviewed

5) Chapter 5 covers the mathematics and definitions involved in estimating component conditional kill probability. Ways of estimating degraded performance caused by damage are included in this chapter

6) Chapter 6, the last major element in target vulnerability analysis, synthesizes the parts into an integrated whole. Vulnerability methods for several types of targets are given as examples

7) Chapter 7, the final chapter, gives the opposite side of the coin from vulnerability, ie, vulnerability reduction analysis. It discusses pri-

marily the methods that can be employed to decrease vulnerability of our own "targets"

The handbook includes a Glossary of vulnerability terms, an extensive Bibliography, and a subject Index. It presents the methodology for estimating target vulnerability and includes examples of actual estimates. It is *not*, nor is it intended to be, a compendium of target vulnerability or terminal ballistic data. Other sources for such information must be sought by the reader who wants or needs such data; these sources are adequately referenced in later chapters
Refs: 1) R.I. Rossbacher, "Methodology of a Vulnerability Study", NWL Tech Memo T-3/64, US Naval Weapons Lab, Dahlgren, Va (1964) [AD 348-907] 2) T.D. Kitchin, "Research Effort to Evaluate Target Vulnerability", Tech Rept AFATL-TR-70-38, Methonics, Inc, Air Force Armament Lab, Eglin AFB, Fla (1970) [AD 888-846] 3) Anon, EngrgDesHndbk, "Basic Target Vulnerability (U)", DARCOM-P-706-163(C) (1977) [ADC 013-060]

VX. Quick-acting casualty agent.

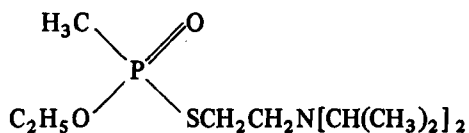

mw 267.38; odorless amber colored liq similar in appearance to motor oil; bp, 298° (calcd) decomps; fr pt, below -51°, -39° calcd; fl pt, 159°; vapor d (compared with air), 9.2; liq d, 1.0083g/cc at 25°; vapor press, 0.0007mm Hg at 25°; volatility, 10.5mg/m³ at 25°; latent heat of vaporization, 78.2cal/g at 25°; CAS Registry No [50782-69-9]

Decomposition temp. Half life: 36 hrs at 150°; 1.6 hrs at 200°; 4 minutes at 250°; 36 seconds at 295°

Rate of hydrolysis. Half-life at 25°, pH 2-3, 100 days; pH 13, 16 minutes; pH 14, 1.3 minutes

Hydrolysis products. Diethyl methylphosphonate, 2-diisopropylaminoethyl mercaptan, ethyl hydrogen methylphosphonate, bis (ethylmethyl-

phosphonic) anhydride, and bis S-(2-diisopropylaminoethyl) methylphosphonodithioate. Toxic hydrolysis products form at pH 7-10

Stability in storage. Relatively stable at room temp. Unstabilized VX of 95% purity decompd at a rate of 5% per month at 71°

Action on metal or other material. Negligible on brass, steel and aluminum

Median incapacitating dosage (ICt₅₀). 50mg-min/m³

Median lethal dosage (LCt₅₀). 100mg-min/m³

Rate of detoxification. Low, essentially cumulative

Skin and eye toxicity. Extremely toxic by skin and eye absorption. Liq does not injure the skin or eye, but penetrates rapidly. Immediate decontamination of the smallest drop is essential

Rate of action. Very rapid. Death usually occurs within 15 minutes after fatal dosage is absorbed

Physiological symptoms. Individuals poisoned display the following symptoms: difficulty in breathing; drooling and excessive sweating; nausea; vomiting, cramps, and involuntary defecation and urination; twitching, jerking, and staggering; headache, confusion, drowsiness, coma, and convulsion; and, when the agent is inhaled, dimness of vision and pinpointing of the eye pupils

Protection required. Protective mask and protective clothing

Decontaminants. Supertropical bleach slurry; DS2 soln; hot soapy water. Liq agent on the skin may be decontaminated by use of the skin decontamination pad in the M13 Individual Decontaminating and Reimpregnating Kit, or the new M258 Skin Decontamination Kit

Persistence. Depends upon munitions used and the weather. Heavily splashed liq persists for long periods of time under avg weather conditions

Refs: 1) Anon, "Field Manual—Military Chemistry and Chemical Compounds", Army FM 3-9, Air Force AFR 355-7 (1975), 3-5 2) B.L. Harris et al, "Chemicals in War" in "Kirk-Othmer, Encyclopedia of Chemical Technology", Vol 5, 3rd Ed, J. Wiley & Sons (1979), 398 & 413

W

W. A. (Powder). A smokeless powder manufd in the USA by the American Smokeless Powder Co and the Lafflin and Rand Powder Co (see Vol 7, L2-R). It was prepd by mixing NC, dissolved in acet, with NG and powdered K nitrate or amm nitrate, and grained either as cords or single perforated cylinders

Ref: Daniel (1902), 799

WAAM Program. The *Wide Area Anti-armor Munitions* program is a high priority US Air Force effort designed to provide tactical air forces with a weapon system that will be capable of multiple kills against tanks and other armor from a single aircraft pass. The system is to be suitable for use under all weather conditions and by day or night. The goal is to improve the current US armor kill-per-pass capability by a factor of 4 to 8 times. Initially the system is being considered for the A-10 ground attack aircraft but it will be suitable for use with other types of aircraft engaged in operations against concentrations of armor

Four concepts are being studied:

ACM (Anti-armor Cluster Munitions)

This is an evolution of existing cluster-bomb technology, and the aircraft would normally employ a low-level delivery pass to release the cluster-bomb canister. The latter contains a large number of sub-munitions which are allowed to drift to the ground supported by parachutes. In this way, several hundred sub-munitions can be delivered on a single aircraft pass. An important feature of the sub-munitions is the use of Self-Forging Fragment warheads (SFF) which reportedly have a very high lethality against armor. The SFF warhead, in one form, consists of a tubular-shaped chamber about 20cm long and 25cm in diameter, and the two ends of the chamber are sealed by a concave copper disc. On detonation the two copper discs are ejected with considerable force, deforming to adopt a projectile-like form. Typically these projectiles attain velocities in the region of 2100 to 3000 m/s, and tests have shown that several inches of armor plate can be penetrated. Ranges of 10 to 150m from the point of detonation can be achieved. The ground pattern covered by the ACM depends on the height and speed of the aircraft at release of the cluster-bomb, but in

general a low-level release produces an elongated ground pattern while higher release results in more lateral spreading of the sub-munitions. On reaching the ground, the sub-munitions remain slightly above the level of the ground because of penetrator spikes on their undersides which form supports for the sub-munition by sticking into the ground

Cyclops

This is a much more sophisticated concept than ACM although it is also likely to be deployed in cluster-bomb type dispensers. There will be fewer sub-munitions however, perhaps 10 to 15 in each, but very large coverage patterns are one of the advantages claimed for the system. A high kill ratio of the tanks within the coverage pattern is also expected. Each Cyclops sub-munition is supported after release from the cluster-bomb container by a parachute that imparts a rotation on the payload as it descends. Each payload consists of a sensor and a housing for a projectile munition, the latter being equipped with an SFF warhead. As the payload rotates during descent, the sensor is carrying out a 360° search of the terrain below and when a tank or equivalent target is detected, the payload is first stabilized and the projectile is launched at the target. A variety of sensor techniques are being studied for use in the Cyclops application but the most favored ones are infra-red and the millimeter-wave seeker (MMW)

ERAM (Extended Range Anti-Armor Mine)

This concept is apparently an enhancement of the ACM system, with a very large number of mines being emplaced by an aircraft making a single low-level pass over the anticipated line of advance of the enemy armored formation. Several hundred such mines could be emplaced in this way by day or night and in any weather conditions. Each ERAM has a sensor that detects the passage of an armored vehicle at ranges of possibly up to 150m, whereupon the mine is projected into the air again by an explosive charge, and if the target is locked onto, the SFF warhead is detonated. Multiple shots for each mine are possible

WASP (Mini-missile)

This is the most advanced of the WAAM concepts and entails loading miniature missiles, each with its own new-technology seeker into cluster-bomb containers for low-level stand-off

delivery by the ground attack aircraft. The WASP mini-missiles would be capable of individual independent target acquisition and tracking, and would probably employ a shaped charge warhead for armor penetration, although the SFF warhead will remain as an alternative

The WAAM program was started in 1975, and work is concentrated at the Armament Development Test Center, Eglin AFB. All four concepts outlined above will be tested competitively to determine which should be put into production

Ref: R.T. Pretty, Ed, "Jane's Weapon Systems, 1979-80", 10th Ed, Franklin Watts, NY (1979), 150-51

Waffen. Patented in the late nineteenth century the following expl: blasting gelatin contg 94% NG, 40.00; Na nitrate 22.50; wood flour 36.00 PA 0.25; S 1.0; and soda ash 0.25%

Ref: Daniel (1902), 799

Wagner. Patented in Ger in 1894 the following safety expl: Amm nitrate 90 to 98 and resin 10 to 2%. It was modified in 1895 (BritP 14775) as follows: Amm nitrate 90 to 98, resin 5, and chromium salts 5 to 3%, the latter ingredient being added as a cooling agent. In the prepn of these mixts, all ingredients were pulverized and then heated to a temp sufficient to soften the resin. After thorough mixing, the mass was cooled and grained

Ref: Daniel (1902), 800

Wahlenberg. Patented in Engl in 1876 expls prepd by mixing pulverized Amm nitrate with a small quantity of paraffin wax and Nitrobenzene. See also in Vol 2, C207-L

Ref: Daniel (1902), 800

Walleye. US guided bomb. The AGM-62 Walleye is an unpowered glide bomb which has been developed in two versions: Walleye I, which has a 385-kg (850-lb) HE warhead; and Extended-Range Data-Link Walleye, with a 907-kg (2000-lb) HE warhead, larger wings and data link for engagements at longer ranges. The weapon was

designed for the destruction of large semihard targets such as bridges, air base facilities, and ships

The Walleye family was developed by the US Naval Weapons Center at China Lake and a production contract for Walleye I was awarded to Martin Marietta Aerospace in 1966; Hughes Aircraft Co began production as second-source contractor in the following year. The AGM-62 arms a wide variety of US Air Force and US Navy attack aircraft, seeing action in the Vietnam war, and has also been supplied to Israel

The pilot or second crew member of a Walleye-equipped aircraft has a monitor on which he can see the view from a television camera mounted in the weapon's nose. He steers the camera, by means of a joystick, so that cross-wires are placed over the target and the bomb is then released to home automatically on to that point. In the larger, extended-range version the weapon can be dropped from one aircraft and then locked on to its objective by another, using the data link to carry video signals in one direction and positioning commands for the camera in the other

Refs: 1) R.T. Pretty, Ed, "Jane's Weapon Systems, 1979-80", 10th Ed, Franklin Watts, NY (1979), 143-44 2) B. Fitzsimons, Ed, "The Illustrated Encyclopedia of 20th Century Weapons and Warfare", Vol 24, Purnell Reference Books, Milwaukee (1979), 2584

Wallonite. A turn-of-the-century Belg blasting and coal mining expl available in three formulations:

	I	II	III
Amm nitrate, %	90	70	70
Na nitrate, %	—	20	25
Nitrated resin, %	10	10	5
Charge limité, g	50	125	600

Ref: Marshall, Dict (1920), 101

Walker, John (1780-1859). Brit inventor of the friction match. Walker was articled to a surgeon in his native town of Stockton-on-Tees, and indeed practiced, but an increasing aversion to surgical operations turned his interest to chemistry. He set up in business as an apothecary about 1818, and in his leisure time worked on means of

producing fire. Unlike nearly all his contemporaries in this field, he did not confine himself to preparations containing phosphorus, and about 1827 he invented, and began to sell, the first friction matches. These were wooden splints coated with sulfur and tipped with a head made of a mixture of K chlorate, Sb sulfide, and gum arabic. The match was struck by gripping the head in a piece of sandpaper (supplied with the matches) and withdrawing sharply; fifty were sold for a shilling. Although Walker did not patent his invention, and consequently had many competitors, he made a considerable fortune

See also under "Match" in Vol 8, M39-R to M41-L

Ref: T.I. Williams, Ed, "A Biographical Dictionary of Scientists", 2nd Ed, John Wiley & Sons, NY (1974), 539

Walsrode Powders. Smokeless powders used primarily in sporting weapons, manufd at the end of the last century by Wolff & Co at Walsrode, Ger, and by the Chilworth Gunpowder Co, Ltd in Engl. The original proplnt was prepd by gelatinizing pure NC with ethyl acetate and adding water (25% of total volume) to the resulting jelly. The mixt was then kneaded and, while continuing this operation, live steam was introduced. This resulted in the formation of very small grains of gelatinized NC. For removal of volatile solvent, the grains were treated under pressure with boiling water, dried, and screened to the desired size (Ref 1). The compn of such a proplnt, as given in Refs 2 and 4, was as follows: NC 98.6 and volatile matter 1.4%; its calorific value was 1014kcal/kg, and volume of gas at NTP was 875 ℓ /kg of which 14.8% was N₂

A different compn for Walsrode is given in Ref 3: Guncotton 77, Ba nitrate 10, grease 7, agar-agar 3, glue 2 and moisture 1%

Refs: 1) Daniel (1902), 801-02 2) Marshall 1 (1917), 327 3) H. Brunswig, "Das Rauchlose Pulver", W. deGruyter, Berlin (1926), 134 4) Anon, "Thorpe's Dictionary of Applied Chemistry", Vol 4, Longmans Green, London (1940), 530

Walsrode Sicherheits-Sprengstoff. An older Ger coal-mine expl contg AN, TNT, flour, a little

Guncotton, and sometimes Na chloride

Ref: Marshall, Dict (1920), 101

Walter Explosives. Between 1942 and 1945, a team of chemists under the direction of Dr Hans Walter and which included Dr Benno Walter, developed several expls by using methanol and ammonia as starting materials. The work was started in the Degussa Laboratories in Frankfort on Main, and was transferred to Tetschen, Czechoslovakia in 1944. The most important expls developed by this group were **MAN-Salz**, **Myrol**, and **TETRA-Salz**. Of these, Walter considered Myrol as the most important

A few less important expls as well as derivatives of the above three materials, and various mixts containing them were also investigated, such as: **DI-Salz**, **Formit**, **MAN-Salz** plus Na nitrate, **MAN-Salz** plus Amm nitrate, **MAN-Salz** perchlorate and **TRI-Salz**

Ref: H. Walter et al, "German Development in High Explosives", FIAT Final Rept No 1035, PB Rept No 78271 (1947)

Walther. Ger small-arms manufacturer. The Walther Waffenfabrik of Zella Mehlis, Ger, was founded in 1886 for the production of sporting arms. In 1908 the company produced its first pocket automatic pistol, the Model 1. Improvements were gradually incorporated into the basic design, and in 1915 the company produced a military pistol, the Model 6. It was an attempt to fulfill the demand for pistols which had arisen during WWI, and was simply an enlargement of the Model 4 pocket pistol, chambered for the 9mm (0.354 inch) Parabellum cartridge. Thus, it was a fixed-barrel blowback with the recoil spring wrapped around the barrel and inside the slide. To give the barrel a reasonable length, it extended in front of the slide, and an extension piece was attached to the slide to conceal the recoil spring and carry the foresight. As might be expected, the 9mm Parabellum stressed the blowback design to the limit, and the Ger army was not happy with it. Relatively few were made and it was never offered commercially

Apart from the Model 6, Walther pistols had acquired a good reputation for sound workmanship and reliability, and in the 1920s the com-

pany decided to make a bid for the police market. This resulted in the Model PP, or Polizei Pistole of 1929 which retained the usual Walther fixed barrel with axial recoil spring, but it was given an external hammer, and a double-action lock. The whole design was streamlined and refined to the point where it made virtually every other pocket automatic obsolete overnight. Produced in 7.65mm (0.301 inch) caliber the PP was an immediate success and became the preferred police pistol thruout Europe in the 1930s. Versions in 0.22 inch (5.59mm), 6.35mm (0.25 inch), and 9mm short chambering were produced, though the 6.35mm version was soon dropped. Production continued during WWII, being taken for military use; after the war the patents covering the various features were still valid and Walther was able to negotiate a license agreement with Manurhin of Fr, whereby Manurhin made the PP and other Walther pistols. This arrangement enabled the Walther company to re-establish itself in Ulm, and in the mid-1960s production of the PP returned to the Walther factory

The Model PP has been fairly widely copied. The first copies appeared in Spain in prewar days and were unlicensed due to the peculiar Spanish patent laws of the time. Postwar copies have been made by Femaru in Hungary and Kerrikale in Turkey. A copy is also made in East Ger, and the Soviet Makorov leaned heavily on the PP for its inspiration. The PP was followed in 1931 by the PPK which stood for Polizei Pistole Kriminal, meaning a pistol to be carried by plain-clothes men. It was simply a smaller version of the PP, chambered in the same selection of calibers

Having catered to the police market, Walther turned to the military field, and in 1934 offered the Ger army their Model MP (military pistol). This was simply a scaled-up PP chambered for the 9mm Parabellum cartridge – a modernized version of the Model 6

Walther then turned to a completely new locked-breech design which appeared in 1937 as the Model AP (Armee Pistole). Barrel and slide rode in the pistol frame, the front of the slide being extensively cut away to expose the rear of the barrel. On firing, both recoiled together for a short distance locked by a wedge beneath the chamber. This wedge was then cammed down to

unlock the slide, and struck a buffer in the frame to halt the barrel while the slide continued to recoil. On the return stroke, impelled by two return springs alongside the slide, a fresh round was chambered and barrel and slide were locked together again. Firing was done by an internal hammer, a double-action lock was fitted, and the pistol was chambered for the 9mm Parabellum cartridge

Some 200 or so Model AP were made and, after testing them, the Army Weapons office declared a preference for a pistol with an external hammer, on the grounds that an internal hammer gave no immediate indication of whether or not it was cocked. Walther therefore reworked the AP design, giving it an external hammer and calling the result the Model HP (heeres pistole). It was put forward for military test and also placed on the commercial market

The army approved the HP, subject to some small modifications to simplify mass production, and it was adopted as the Pistole 38. The total number of P-38s made is not known, but is believed to be in excess of 1000000. As well as being produced by Walther, they were also made by Mauser and by Spreewerke of Berlin. It was also adopted by the Swedish army in 1939 as their P-39, but only about 2000 were shipped before the outbreak of war put an end to the export business

When the Bundeswehr was set up in the 1950s, they selected the P-38 as their standard pistol, and in 1957 production began again at Ulm. The new model, known as the P-1, is identical to the prewar version except that the slide is made of light alloy and there are small changes in the firing pin and safety catch. It is also sold commercially in the 0.22 inch, 7.65mm Parabellum and 9mm Parabellum chambering

In the early 1960s the company developed a submachine gun, the Walther MP-K or MP-L, the difference being a matter of the length of the barrel. The weapons are of pressed and welded construction with an overhung bolt and a folding metal stock. They are quite compact, blowback operated, and incorporate an ingenious sight which uses an open notch for snap-shooting and an aperture for more careful aiming. They have been evaluated by several countries, but apart from being adopted by various police forces, have not been purchased in any number for

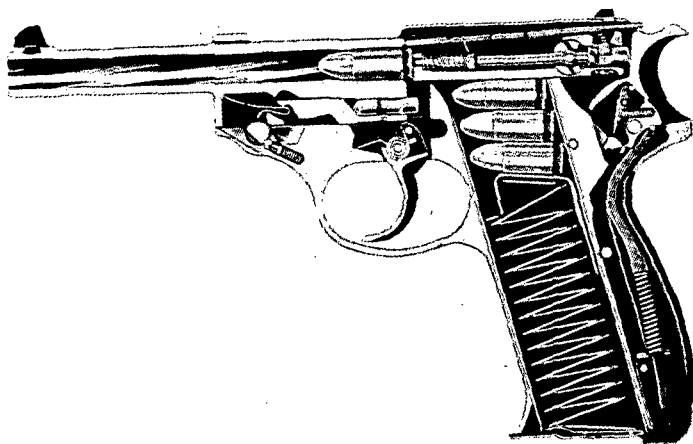

Sectional view of P.38 pistol



P38 pistol stripped

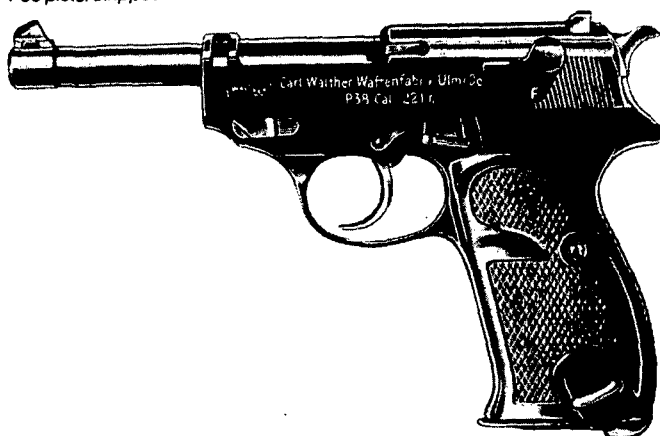

Pistol P38 in 22RF calibre

Fig 1 Walther Model P-38 Pistol (from Ref 3)

military use

Refs: 1) I.V. Hogg & J. Weeks, "Military Small Arms of the 20th Century", Hippocrene Books, NY (1977), 34-35 2) B. Fitzsimons, Ed, "The Illustrated Encyclopedia of 20th Century Weapons and Warfare", Purnell Reference Books, Milwaukee (1979), 2585 3) J. Weeks, Ed, "Jane's Infantry Weapons, 1979-80", 5th Ed, Franklin Watts, NY (1979), 24-26

Wanklin. Patented in Engl in 1888 an expl compn prepd by mixing 2 to 5 p of NC or Dynamite with 1 p of urea nitrate
Ref: Daniel (1902), 802

Ward and Gregory Powder. The following expl mixt was patented at the end of the 19th century: K chlorate 97.4, amorphous P 1.3 and pulverized coke 1.3%. After mixing these ingredients in the presence of a volatile solvent, some paraffin or tallow was incorporated (Ref 1). Giua (Ref 2) gives the following formulation under the same name: K chlorate 77, K ferrocyanate 10, starch 7, crude mineral oil 6, K dichromate 2 and charcoal 3%

Refs: 1) Daniel (1902), 802 2) Giua, Trattato 6 (1959), 400

Warmlagermethode 75°. Older Ger stability test for NC and proplnts depending on the direct observation of brown fumes. Five grams of the sample is heated in stoppered tubes of 200mm length and 28mm diameter at 75°. The tubes are left open for 16 hrs and are then stoppered, and the heating is continued without interruption until distinct brown fumes appear. They are opened once a week for 10 minutes to renew the supply of oxygen necessary to convert NO to NO₂. The test is stated to give reliable results and to give good concordance in tests done on the same powder at different times. A temp of 100° is sometimes used
Ref: Reilly (1938), 81

Warren. Proposed in the last quarter of the nineteenth century an expl compn prepd by adding to 70 p of pulverized BlkPdr, 30 p of a

mixt consisting of 1 p NC and 10 p NG. Some nitrohydrocellulose was then added to prevent exudation in storage

Ref: Daniel (1902), 802

Warrite. An older Dynamite contg about 30% NG and an active absorbent, such as K, Na, or Amm nitrates

Ref: Daniel (1902), 803

Wasacord. Trade name of a detonating cord marketed by Wasagchemie G.m.b.H. in the Ger Federal Republic. It is available in a variety of filling grades, contg from 12 to 40g of PETN/m
Ref: R. Meyer, "Explosives", Verlag Chemie (1977), 314

Wasagel 1 & P1. Trade names of slurry blasting agents distributed by Wasagchemie G.m.b.H. in the Ger Federal Republic. Wasagel P1 can be loaded by pumping. Ref 1 gives the following data on Wasagel 1:

State	Muddy grey-black
Oxygen balance	-16.4%
Volume of detonation gases	824ℓ/kg
Heat of explosion	1423kcal/kg=5958kJ/kg
Specific energy	124kt/kg=1216kJ/kg
Density	1.45g/cc
Pb block test	370cc
Detonation velocity	4800m/sec
Impact sensitivity	No reaction at 5kpm

Ref 2 lists a weight strength of 78% for Wasagel 1, and a density of 1.30g/cc and weight strength of 78% for Wasagel P1

Refs: 1) R. Meyer, "Explosivstoffe", Verlag Chemie, Weinheim (1975), 286 2) Ibid, "Explosives", Verlag Chemie, NY (1977), 315

Wasamon W & F. Trade names of powder form blasting agents distributed by Wasagchemie G.m.b.H. in the Ger Federal Republic. Both can be used in large diameter bore holes, Wasamon F in a free flowing, uncartridged state. Ref 1 contains the following data:

Ref 2 gives a relative weight strength of 70% for both expls

Refs: 1) R. Meyer, "Explosivstoffe", Verlag Chemie, Weinheim (1975), 287 2) Ibid, "Explosives", Verlag Chemie, NY (1977), 315

Washing-out of HE from Shells. See under "Reclamation of Energetic Material Components from Ordnance Ammunition" in Vol 9, R146-R

Washout. A water jet built into the chamber of a heavy gun, so that water can be squirted in to extinguish any smouldering residue from the bag charge before the breech is opened. Such residue is rarely met, but if, as is generally the case with coast and naval guns, someone is standing close behind the breech with the next round's bag charge in his arms, it needs only one flash-back to kill everybody in the turret, and the draft

Wasamon

	W	F
State	Golden-white powder	Violet-black powder
Oxygen balance	+0.50%	+0.07%
Volume of detonation gases	906ℓ/kg	884ℓ/kg
Heat of explosion	922kcal/kg = 3860kJ/kg	976kcal/kg = 4087kJ/kg
Specific energy	104mt/kg = 1020kJ/kg	101mt/kg = 990kJ/kg
Energy level	115mt/ℓ = 1128kJ/ℓ	106mt/ℓ = 1039kJ/ℓ
Density	1.1g/cc	1.05g/cc
Pb block test	310cc	315cc
Relative weight strength	65%	75%
Detonation velocity	3700m/s	4200m/s
Impact sensitivity	2kpm = 20J	2kpm = 20J

generated by the breech block swinging open can easily fan a smouldering remnant into a blaze which will ignite the gas-air mixture in the chamber mouth with spectacular and disastrous effects

"A washout is also worth its weight in gold in the event of a misfired bag charge; this, too, could be smouldering and could explode violently as the breech is opened in order to remove it. But a squirt from the washout removes all danger"

Ref: I.V. Hogg, "British and American Artillery of World War 2", Hippocrene Books, NY (1978), 256

WASP. See under "WAAM Program" in this Vol

Wass. Patented at the end of the last century a smokeless powder consisting of partially gelatinized NC mixed with manganese sesquioxide, Mn_3O_4

Ref: Daniel (1902), 803

Wasserfall, Peenemünde. Ger WWII surface-to-air missile. In 1941 the Peenemünde research station began private-venture studies of surface-to-air missiles, and the following year the Ger authorities were forced to initiate an anti-aircraft rocket/missile program to counter Allied bombers. In November 1942, Wernher von Braun submitted a paper suggesting a single-stage liquid-fueled SAM — which in many ways resembled Peenemünde's A4 ballistic missile — in response to the report issued by Gen von Axthelm, inspector-general of anti-aircraft defenses, calling for a coordinated development program

The RLM (Ger air ministry) studied von Braun's report and awarded a development contract for Wasserfall, design studies of which were completed in early 1943. More than 25 designs were tested in wind tunnels at up to 3200km/h (2000mph) but work proceeded only slowly, the first fully successful flight (with the third prototype missile) not taking place until March 1944. A total of 25–27 Wasserfalls were fired, of which ten were failures, and development was officially abandoned in February 1945. The Luftwaffe's Flak Training and Research

Section 700, which was responsible for evaluating competing SAMs, estimated in 1944 that 600 batteries of Schmetterling and 900 of Wasserfall would be needed to defend Ger against bomber attacks from the west, with a total of 670 batteries doing the same job on the Russ front. The same unit estimated, however, that only three Wasserfall batteries could have been operational by the end of 1945

Wasserfall was built entirely of steel because light alloys were in short supply, and the missile was big and heavy. It had to be launched vertically, and a primitive computer was required to ensure that the round was launched in the correct direction and gathered by the associated optical or radar tracking devices as quickly as possible. Beam-riding guidance was proposed originally, but the technology was not sufficiently advanced at the time; a visual command system was therefore adopted initially, with radar planned to supersede it later

Wasserfall was powered by a Peenemünde P IX liq-proplnt rocket motor burning *Visol* (vinyl isobutyl ether) oxidized by *SV-Stoff* or *Salbei* (fuming nitric acid) to produce 7800kg (17160 lbs) of thrust for 42 seconds. Enemy bombers would be tracked optically or by radar, the Einlenk computer would process this information and aim the optical or radar missile tracker, the round would be launched and come under ground control within six seconds. The initial all-optical system was known as Burgand, and used the Kehl-Strassburg command link to operate graphite vanes in the motor exhaust and steering surfaces on the fins

Length: 8.4m (27 ft, 7 in)

Span: 2.7m (8 ft, 10 in)

Diameter: 95cm (3 ft, 1 in)

Weight: Approx 3800kg (8400 lbs)

Speed: 2700km/h (1700mph)

Range: 26.5km (16.5 miles)

Altitude: 18300m (60000 ft)

Warhead: 150kg (330 lbs) HE

Ref: B. Fitzsimons, Ed, "The Illustrated Encyclopedia of 20th Century Weapons and Warfare", Vol 24, Purnell Reference Books, Milwaukee (1979), 2588

Water Content. See under "Moisture" and "Moisture, Analytical Procedures" in Vol 8, M149-L to M154-L

Water-driven Injector Transport (Emulsions-förderung; Transport par injection d'eau). The liq nitric esters, Nitroglycerin and Nitroglycol, are highly sensitive to impact. Thus, handling of these materials in the expls plant in a free unbound condition is extremely dangerous. They are therefore conveyed in the form of emulsions. The expl oil is sucked up by means of a compressed-water-driven injector, and the emulsion is sent thru conduit pipes for processing in mixing houses. It is then separated from the carrier water and, if required, dried by passing thru a salt filter

Ref: R. Meyer, "Explosives", Verlag Chemie, NY (1977), 315

Water, Effect on Energetic Materials. See under "Moisture" in Vol 8, M149-L to M154-L

Water Gels. See under "Slurry Explosives" in Vol 9, S121-L

Water, Its Hazardous Reactions and Use in Energetic Materials. This article surveys the hazardous reactions of water (w) with elements, compds and compns, its use with energetic materials, its effect on detonation parameters, as well as other pertinent topics

See also in Vol 8, M149-L to M154-L under "Moisture", P502-L to P504-R under "Pyrophoric Incendiary Agents", and in Vol 9 under "Slurry Explosives"

Hazardous Reactions with Water-Reactive Materials. Accdg to Refs 1, 2, 3 & 5, w reacts with a variety of elements, compds and mixts to generate at RT either an expln or a combustion reaction because of the hydrogen released and the heat of reaction. Table 1 presents an identification of the reactants, and a generalized classification of the results of these reactions into either "expln" or "combustion". From Ref 3, a more quantitative approach yielded data in terms of temp increase and the time required to reach the max temp on a selected group of w-reactants (Table 2). Table 3 displays the results of an attempt to determine if the order of addition (effects of dilution and/or surface

area) of the reactants affects the sensy and rate of reaction

Table 1
Classification of Hazardous Reactions Generated from the Reaction of Water with Water-Reactive Materials (from Refs 1, 2, 3 & 5)

Material	Type of Reaction	
	Expln	Combustion ^a
Ba (?)		X
Ca	X	
Ce	X	
Li		X
Mg (burning)	X	
K	X	
Rb	X	
Na	X	
Na amalgam		X
Na-Pb alloy		X
Na-KO ₂	X	
Cd amide	X	
Li amide		X
Mg diamide		X
Pb imide	X	
Ba carbide		X
Ca carbide		X
K graphite		X
K carbide	X	
Na carbide	X	
U monocarbide		X
K carbonyl	X	
Na carbonyl	X	
Bi pentafluoride		X
Br pentafluoride	X	
Ca hypochlorite		X
Cl trifluoride		X
Li hypochlorite		X
P trichloride		X
Tetrabromosilane		X
Trichlorosilane		X
Ti dibromide		X
Ti dichloride		X
Ti diiodide		X
Al borohydride	X	
Diborane		X
Ba hydride		X
Be hydride		X
Be borohydride		X
Na hydride		X
K hydride		X

Material	Type of Reaction		Material	Type of Reaction	
	Expln	Combustion ^a		Expln	Combustion ^a
Li Al hydride		X	Diethyl chloroalumine		X
Li borohydride		X	Triethyl Al	X	
Li hydride		X	Triphenyl Al	X	
Mg hydride		X	Triethyl Al etherate	X	
Na Al hydride	X	X	Dimethyl Be		X
Cd nitride	X		Diisopropyl Be	X	
Ce nitride		X	Diethyl Cd	X	
Ba peroxide	X		Butyl Li		X
Ce oxide		X	Li tetramethyl borate		X
K peroxide	X		Mg diphenyl		X
Al phosphide ^{-b}		X	Na nitromethane	X	
Ca phosphide ^{-b}		X	Na methylate		X
Ce phosphide ^{-b}		X	Na acetate		X
Cu (ic) phosphide ^{-b}		X	Methyl trichlorosilane		X
K phosphide ^{-b}		X	Hexachloroethane		X
Na phosphide ^{-b}		X	Mg powder/Ag nitrate powder		X
Ru phosphide ^{-b}		X	Al powder/Na peroxide		X
Sn phosphide ^{-b}		X	Liquified natural gas (LNG)	X	
Ce silicide	X		(LNG) ^{-c}		
K silicide	X		Powdered mixt of Mg/Cu		X
Li silicide		X	sulfate/AN/K chlorate		
Na silicide	X				
Ba silicide		X			
K sulfide		X			
Na sulfide		X			
P pentasulfide		X			
Di K nitroacetate	X				
Na hydrazide	X				
Na ₂ P ₂ ·2NH ₃		X			
Ru silicide	X				
Diethyl Al bromide		X			

Footnotes to Table 1:

a-by contact with liq w or moist air, resulting in the generation of gaseous hydrogen and heat, leading to vigorous ign accompanied by flame .

b-yields phosphine, which in turn yields hydrogen

c-accdg to Ref 4, LNG enriched with <50 mole % of methane will superheat and expld at room temp by wetting with w. This is a flameless non-chemical, satd liq-to-vapor-state change

Table 2
Maximum Temperature Rise Exhibited by Various Substances Reacting with Water (from Ref 3)

Substance	Quantities	Maximum Temperature Rise Recorded, ΔT_{\max} , °F	Time to Maximum Temperature, t_m , min	Spontaneous Ignition	Toxic Gas
CaH ₂	10g into 10g H ₂ O	725	4	Yes	No
NaNH ₂	10g into 5g H ₂ O ^a	400	3 sec	Yes	Yes
Al ₄ C ₃	10g into 10g H ₂ O	387	11	No	No
CaC ₂	20g into 10g H ₂ O	367	14	No	No
CaO	31.1g into 10g H ₂ O	361	2	No	No
P ₂ O ₅	20g into 8g H ₂ O	368	45 sec	No	No
NaH	10g H ₂ O into 5g ^a	278	18 sec	Yes	Yes
Ca	10g H ₂ O into 20g	266	6.5	No	No
Ca ₃ P ₂	20g into 10g H ₂ O	254	16	Yes	Yes
Na ₂ O ₂	20g into 10g H ₂ O	223	1.5	No	No
H ₂ SO ₄	10g H ₂ O into 20g	208	10 sec	No	No
LiH	10g H ₂ O into 5g ^a	179	1.25	Yes	No
PCl ₅	10g into 8g H ₂ O	150	4	No	Yes
LiNH ₂	10g H ₂ O into 10g	121	30 sec	No	Yes
NaOCH ₃	20g into 8g H ₂ O	114	15 sec	No	No
CH ₃ COCl	20g into 10g H ₂ O	101	15 sec	No	Yes

Footnote to Table 2:

a- Five grams was the largest amount of these materials used because of the severity of the reaction

Table 3
Water Reactivities Determined by Using 20 Grams of Each Material and 10 Grams of Water (from Ref 2)

Substance	Substance Added to Water		Water Added to Substance	
	ΔT_{\max} , °F	Rank ^a	ΔT_{\max} , °F	Rank
Al ₄ C ₃	280	1	349	1
CaC ₂	367	2	250	4
Ca ₃ P ₂	254	3	220	5
P ₂ O ₅	239	4	318	2
Na ₂ O ₂	223	5	183	7
CaO	217	6	131	9
H ₂ SO ₄	185	7	208	6
PCl ₅	146	8	139	8
Ca	131	9	266	3
LiNH ₂	119	10	107	10
CH ₃ COCl	101	11	98	11
NaOCH ₃	54	12	54	12

Footnote to Table 3:

a- Decreasing order of heat release

Refs: 1) Ellern (1968), 43 ff, 280 & 295 ff
 2) J.R. Gibson & J.D. Weber, "Handbook of Selected Properties of Air- and Water-Reactive Materials", **RDTR 144**, Library of Congress, Wash, DC, Contract PO-6-0024 (1969)
 3) C.M. Mason & J.C. Cooper, "Classification of Hazards of Materials, Water-Reactive Materials and Organic Peroxides", **TSA-20-72-2**, US Bu-Mines, Pittsburgh, Contract DOT-AS-00007 (1972) 4) D.L. Katz, "LNG-Water Explosions", **CG-D-60-74**, NAS, Wash, DC, Contract DOT-CG-11, 775-A (1973) 5) J.C. Commander, "Explosive Hazards Analysis of Eutectic Solution Sodium-Potassium (NaK) and Potassium Superoxide (KO₂)", **ANCR-1217** (1975) & **CA 84**, 107981 (1976)

Effect of Water on Detonation Parameters

1) B. Yavetlov, "Efficiency of Water-Filled Mixtures of Ammonium Nitrate with Trotyl", *Vzryvnoe Delo* 1966 (60/17), 160-73 (1966) (Russ) & **CA 67**, 55796 (1967) [The author compared dry and w-filled mixts of granular Trotyl (TNT) and AN by means of their heats of expln detd using calorimetric bombs, brisance from Trauzl test data, MacKnee ballistic balance values and ballistic plate tests. Evaluated were composites of AN and TNT in 79/21, 50/50 and 30/70 ratios as well as pure granular TNT. It was found that in the dry state the heat of expln is max for the stoichiometric 79/21 mixt. However, as the TNT content increases, the evolved heat decreases to a min for pure TNT. The w-filled mixts exhibit an opposite trend, viz, the heat of expln increases with TNT content, becoming maximized for 70-100%

TNT. A similar relation is reported for brisance by Trauzl test. In dry mixts the expln efficiency decreases with increasing TNT content (as a result of incomplete reaction), and increases in the case of w-filled expls. The author concludes that for dry mixts the stoichiometry ratio of components prevails, while in w-filled samples the brisance effect is greater for mixts rich in TNT] 2) Y. Bernard et al, "Detonation Characteristics of Liquid Nitropropane II-Nitric Acid Mixtures", *CR, AcadSciParis, Ser A*, **B293B** (20), 1096-99 (1966) (Fr) & **CA 68**, 39485 (1967) [The authors report on the deton parameters of the subject mixt. They found that the deton vel (~6.5km/sec) decreases linearly with increasing initial temp (0 to 29°) and w content. The calcd deton pressure for the reaction (including w) is of the order of 140kilobars]

3) Yu.A. Lebedev et al, "Thermochemical Study of Individual Explosives and Their Mixtures", **ASC FTD-MT-24-98-68** (1968) (AD-675457) [The authors conclude from their experimentation that although w is an inert additive it plays the role of an intimate confining medium on the (usually) dry expl, so that the expl charge detonates not at the filled d but at the d of a single cryst, with more completeness. This is illustrated by the heat of expln data of Table 4. They also point out that the effectiveness of the action of such confinement is essential for expls with negative oxygen balance (such as TNT or Cyclonite) and can depend on the degree of dispersiveness and physical state of the expls. From the data presented here as Table 5, it is possible to note a small dependence of the heat of expln on the degree of dispersiveness and

Table 4
 Heat of Explosion Data for TNT, Cyclonite and PETN Both Dry and Water-Filled (from Ref 3)

Designation	Content of Water in Charge, %	Density of Charge, g/cm ³	Heat of Explosion, cal/g, explosive	Heat of Explosion, cal/g, mixture
TNT	0	0.80	750	750
The same	35.6	1.24	1020	650
Cyclonite	0	1.10	1280	1280
The same	24.7	1.46	1390	1050
PETN	0	1.00	1380	1380
The same	29.1	1.41	1390	990

Table 5
Effect of Physical Continuity on
Water Content and Heat of Explosion of TNT (from Ref 3)

Form of TNT	Density of Charge Without Water, g/cm ³	Content of Water in Charge, %	Heat of Explosion, kcal/kg, according to the relationship	
			to the general mass of the charge	to the weight of TNT
Granulated	1.01	31.8	790	1080
Flaky	0.92	33.5	840	1130
Pressed	0.91	36.1	770	1100

porosity of TNT to illustrate this conclusion. From other data the authors further conclude that aq solns of oxidizer salts such as AN and AP increase the heat of expln and the vol of gases produced over plain w addns, while sharply decreasing the poisonous gas content (CO and NO) of such compds

4) V.G. Voronkov & A.S. Rozenberg, "Explosive Properties of Mixtures Formed by Hydrazoic Acid Gas with Inorganic Diluents", DoklAkad-NaukSSSR 177 (4), 835-38 (1967) (Russ) & CA 68, 61112 (1968) [The authors report on their mathematical analysis of the expl decompn of mixts of Hazide with w. From kinetic data and IR spectra of the decompn products a series of reactions were developed to describe the initiation, growth, and completion of the decompn (deton) process. From these reactions the authors derived a series of differential equations based on the variation of the energy of activation with time. They found that the limiting partial pressure of H azide ign is dependent upon the partial pressure of the diluent (w)]

5) V.I. Vashchenko et al, "Explosion Energy in Water-Filled Hexogen", FizGoreniyaVzryva 3 (7), 429-32 (1971) (Russ) & CA 77, 22440 (1972) [Work on determination of the heat of expln and the type and volume of the gaseous expln products from the deton of w-filled RDX is reported. W was added by first coating the RDX with w, and then by filling the voids between the RDX particles with w. It was found that the heat of expln increases proportionally with the w content to 24% w. Above 24% the heat of expln does not depend on w content. It

was also found that the higher the w content, the lower the vol of expln gases as well as their CO and H₂ content, and the higher the CO₂ and C content of these gases. The authors explain this phenomenon by concluding that the higher "local" pressure formed in the expln, from the role of w as a confining agent, shifts the deton decompn reactions to the right in the following reactions; viz, $2CO \rightleftharpoons CO_2 + C$, and $CO + H_2 \rightleftharpoons H_2O + C$] 6) A.S. Derzhavets, "Detonation Susceptibility and Detonation Capacity of Heat-Resistant Explosives", FTD-MT-24-1362-72, W-PAFB (1972) (AD-751959) [Several conclusions as to the effect of w on the deton of expls such as RDX, GNDS, and NTFA were arrived at as the result of this work; viz, the phlegmatizing effect of w (under high pressure) which has penetrated the pore spaces of an acceptor charge reduces the range of deton transmission from a donor charge, and substantially increases the required critical diameter of the acceptor charge. The author also concluded that the negative influence of hydrostatic pressure on these expl properties is sharply reduced if the charge d is greater than 1.0g/cc because of the reduction in porosity, and hence the w saturation rate] 7) V.B. Ioffe & B.H. Men'shikov, "Effect of Water Content on Various Characteristics of Granular Type Explosives", VzryvneoDelo 71 (28), 221-28 (1972) (Russ) & CA 78, 138454 (1973) [The authors experimented with granular TNT, granular and pulverized AS, VV and 80/20 TNT/RDX mixts. They found that the best detonability and the max gain in energy is obt'd from these mixts with a 10 to 12 wt % w addn]

8) T. Urbański, "Influence of Non-Explosive Liquids on the Detonation Rate of Solid Explosives", *ArchProcesouSpalania* **3** (2), 117-32 (1972) & *CA* **78**, 99944 (1973) [The author discusses the effect on the deton rate of adding w to PETN, RDX, p-Nitrotoluene or TNT in concns of from 5 to 40%. He reports that at low w concns the deton rate is minimized. As the w content increases the deton rate curve passes thru a maximum to reach a second minimum at the higher (~40%) level of w concn. The author concludes that the increase in deton rate can be attributed to three factors, the existence of a covolume, a phlegmatizing factor, and the result of mixing of two components, at least one of which is expl] 9) T.V. Ferris, "Expansion of Methanol-Air Mixtures at Above Atmospheric Conditions", *LossPrevn* **8**, 15-19 (1974) & *CA* **82**, 45989 (1975) [Upper flammability limits were detd for various mixts of methanol with air, or a 30/70 O₂-N₂ mixt with and without w. A rise of 12 vol % in the flammability limit above the nominal value of 36 vol % methanol in w-free air mixts is reported in the presence of liq w] 10) V.G. Bystruev, "Explosive Granulites and Gaseous Explosion Products", *BezopTrPromsti* **17** (12), 46-47 (1973) & *CA* **83**, 134475 (1975) [The effect of w on the gaseous deton products CO and NO obtd from the deton of granulated comml mining expls AS-4 [CA Registry No 39394-85-9] and AS-8 [CA Registry No 56508-96-4] was investigated. It was found that w decreased the CO content approx 95% and increased the NO content of the expln products 3 to 5 times] 11) V.P. Vetluzshkikh & P.S. Danchev, "Energy Characteristics of Multicomponent Water-Filled Explosives", *VzryvnoeDelo* **74/31**, 55-59 (1974) & *CA* **82**, 113749 (1975) [Use of theoretical calcns after a method proposed by B.Ya. Svetlov et al in 1970 indicates that the addn of Na or Ca nitrate to AN-w-filled expls effectively increases d, vol concn of energy and vol of ideal work] 12) M.F. Drukovanyi & O.N. Obermok, "Effects of Water on the Detonation of Water-Resistant Granulated Explosives", *VzryvnoeDelo* **74/31**, 17-21 (1974) & *CA* **82**, 113761 (1975) [A lab investigation of the deton rates of w-filled (≤50%) granular expls such as TNT or Zernogranulite showed a decrease in the sensy and an increase in the critical diam and critical deton rate

of these mixts. The authors conclude from their work that w does not participate in the rapid chem reactions that intensify the deton wave, but contributes only to the change in deton mechanism. That is to say, w-filling of the charge results in almost complete homogenation of the deton mechanism. However, the authors observe, because of the inertness of w, an increase in the deton rate resulting from filling does not always occur, and it may even be lowered] 13) V.N. Mirnyi et al, "Explosive Characteristics of Water-Filled Explosives During Their Mechanized Preparation", *TrProektnNauchnoIsslelInst "Gipronikel"* **61**, 34-40 (1975) & *CA* **84**, 19907 (1976) [The deton parameters of w-filled expls such as Aquatol 65/35C [CA Registry No 57456-49-2], M-15, and GL [CA Registry No 8006-19-7] were investigated. The authors report that the brisance of these expls decreases with w content. For Aquatol 65/35C and M-15, the deton rate increases 10 to 15% at the optimum w content of 15.3%. The deton rate of w-filled GL expls exceeds that of the Aquatols. Of these expls, GL 80/20 was found to have the max heat of expln] 14) I.M. Voskoboinkov et al, "Assessment of Detonation Wave Pulses in Explosives with Inert Filler", *VzryvnoeDelo* **75**, 43-47 (1975) & *CA* **84**, 15287 (1976) [The authors report on their calcn of deton wave impulse from w- or other materials-filled RDX. It was found that the quant aspect of the impulse generated varied with the amt and d of the filler material, ie, bronze or Zn fillers have a larger impulse than w, and B or Al have a smaller impulse] 15) B. Zygmunt, "Explosion Heat of Mixtures: Explosives-Water", *BiulWojskAkad-Tech* **25** (6), 87-93 (1976) & *CA* **86**, 75478 (1977) [Reported is the result of mixing w with expls having a negative oxygen balance, namely, an increase in their heat of expln. The author concludes that this results because there is an increase in expln pressure along with a drop in expln temp]

Safety. 1) C.M. McCloskey & A. Ellis, "Effect of Moisture on the Ignition, Burning and Detonation Characteristics of Benzoyl Peroxide", *TechPapRegTechConfSocPlastEngClevelandSect* **1966**, 68-71 (Sept 1966) & *CA* **66**, 12613 (1967) [Table 6 reports data obtd by ign of various w-filled samples of the peroxide in an instrumented pipe, 15"x1.2", using nichrome wire

Table 6
Water-Filled Benzoyl Peroxide Ignition Data
(from Ref 1)

Water Content, %	Comment	Degree of Sound	Pressure, psi
0.0	deton obtd	loud report	—
0.5–1.0	deton obtd	loud report	—
2.0	vigorous combstn	—	<5
3.0	slow combstn	—	—
5.0	no ign	—	—]

2) D. Kite, Jr, "Safety Hazard Classification of Water-Wet Explosives", PATR 3223 (1965) (AD-460363/5ST) [Table 7 lists deton data for 18 granular w-filled expls loosely packed in Plexiglas tubes of 1.75" ID with wall thicknesses of from 1/8" to 1/4". Expl column lengths were from 10" to 20". Deton was achieved using either 33g Tetryl pellets or 40-grain RDX wafers, electric cap initiated.

Table 7
Detonability of Water-Wet Explosives (from Ref 2)

Explosive	Water Content, %	High Order Deton Achieved?
RDX Class A	Saturated	Yes
RDX Class B	"	"
RDX Class C	"	"
RDX Class D	"	"
RDX Class E	"	"
RDX Class F	"	"
RDX Class G	"	"
Composition C-4	"	"
Composition A-3	"	"
PBX 9404	"	"
PBX Type B	"	"
PBX 9010	"	"
HMX Class A	"	"
HMX Class C	"	"
HMX Class D	"	"
HMX Class F	"	"
PBX-N3	25	"
HMX Class B	44	"
HMX Class E	40	"]

Deton velocities were confirmed using high vel framing cameras. The author concludes that the w content conditions of the test prevail in expl mfg plants after expl washing and filtering. He recommends that these expls be assigned a safety classification of Class 9 at this step in their processing

Sensitivity. 1) B.D. Pollock & R.F. Gentner, "Impact Sensitivity of Wetted Primary Explosives as Determined by the Ball Drop Test", PATR 4311 (1972) [Table 8 lists the impact sensy data found by these workers on unfound dry and w-wet Pb Azide. Addnlly, they found that w completely desensitized Pb Styphnate and Tetracene and that all fully-wetted unconfined primary expls were less sensitive to impact than when dry, but that partially wet (w-soaked but no excess of w present) confined initiating expls are *more* sensitive to impact than when fully dried

Table 8
Impact Sensitivity Data for Wetted Lead Azides

Lead Azide Type	Firing Level, % ^a	Height, inches	
		Dry ^b	Water-Wet
Dextrinated	10	17	≥ 31
	50	20	≥ 42
RD 1333	10	19	16
	50	26	37
PVA	10	16	11.6
	50	23	15
Special Purpose	10	16	36
	50	22	40
Avg (Std Devn)	10	17 (1.5)	21
	50	23 (2.5)	30

Footnotes to Table 8:

a-For 10% pt Bruceton staircase method used — sample size was 20/set; ≥ 4 sets used for each entered value. For 50% pt same procedure — sample 25/set; ≥ 4 sets used for each entered value

b-A 0.5" diam, 8.35g steel ball used. Anvil is of hardened steel. Samples are first soaked in w and then spread on the anvil in the wet state

Water Emulsion Fuels, Propellants and Propulsion Systems. See under "Liquid Propellants" in Vol 7, L34-R to L44-R; under "Propellants, Solid" in Vol 8, P430-L to P439-L; and the following *Addnl Refs*:

Combustion. 1) V.E. Annikov et al, "Effect of Water, Ammonium Carbonate and other Additives on Combustion of Explosives", *FizGoreniya-Vzryva* 5 (1), 60-67 (1969) & CA 71, 40905 (1969) [The authors state that the effects of w on the burning rate of Tetryl and RDX in a constant pressure bomb can be explained by the Zel'dovich (1942) theory. They report that the burning rate of RDX with 10 to 20% w added is higher because of strong turbulence] 2) M.A. Aleshin et al, "Calculation of the Thermodynamic Characteristics of Hydroreacting Aluminum-Water Fuels", *Fiz AerdispersnykhSist* 17, 74-78 (1978) & CA 91, 76312 (1979) [Reported are the thermodynamic calcs made for the hydro-reacting Al-w mixt used as a rocket fuel at a combustion chamber pressure of 40kg/sq cm]

Ignition. S. Sedlacek et al, "Effect of Inert Admixtures on the Ignition Energy in Solid Propellants", *SbVedPrVysSkChemickotechy-Pardubice* 31, 127-55 (1974) & CA 86, 108797 (1977) [Reported is the investigation of the effect of w and Centralite I [CA Registry No 85-98-3] contents on the ign energy of smokeless powder. Expts were performed at an initial temp of 20° and a N pressure of 6 to 28kg/sq cm using the hot-wire method. When low heat flow was used to simulate conditions in ammo and in rocket engines, w content of ≤10% and Centralite content of ≤15% did not affect the amt of ign energy required. However, at high heat flow rates the addns had a marked effect]

Uses. 1) L. Greener & F.A. Hanser, "A Sea-Water Aluminum Torpedo Propulsion System", *Underwater Missile Propulsion*, Compass, Arlington (1967), 283-93 [A torpedo turbine proplsn system which exploits the reaction between Al and sea-w as a power source is analyzed. The power is generated by the reaction of molten Al with w. The authors concluded that this system appears capable of the greatest performance possible from a chemically powered torpedo power plant. They predict that the system will

double propulsion performance at moderate depths, and provide at least a 25% improvement over circa 1967 systems at greater depths] 2) R.K. Multer, "High-Energy Propulsion Compositions from Aluminum and Water", USP 3357186 (1967) & CA 68, 51481 (1968) [The inventor suggests that the Al-w reaction, which releases large quantities of thermal energy, be used for rocket propulsion in a suitable system] 3) R.C. Stechman, Jr & J.C. Campbell, "Water Electrolysis Satellite Propulsion System", *AFRPL-TR-72-132* (1973) (AD 755384) [A report on the use of w as a safe, non-toxic and storable (7 years) proplnt in a rocket engine system designed for the maneuvering and station-keeping of a satellite (Fig 1). Simply stated, the stored w is separated into its components, gaseous hydrogen (GH₂) and oxygen (GO₂), by electrolysis. Ign of these gases at the throat of the rocket's nozzle provides the amount of "thrust" desired. According to the authors, the program met all the design objectives. They conclude that "... The results of the Water Electrolysis Satellite Propulsion System program have demonstrated that a separated gas electrolysis unit which generates gaseous oxygen and hydrogen for use in rocket engines is a safe, cost effective and high performing concept.

The objective of this program, which was to demonstrate the feasibility and capabilities of such a system to meet Air Force objectives, was satisfied.

1. A water electrolysis unit, manufactured by the General Electric Company of Lynn, Massachusetts was tested both at the manufacturer's facility as a separate unit and at Marquardt as a component of the supply system. The results of the tests show that the projected performance of the unit was realized and that no significant

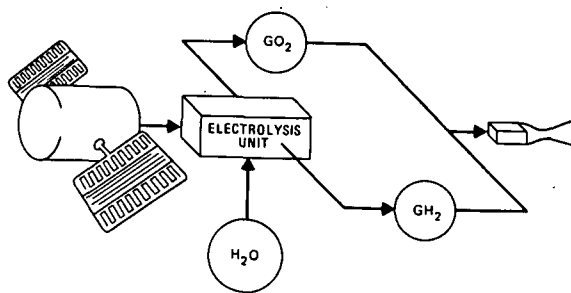

Fig 1 Water Electrolysis System Propulsion Concept (from Ref 2)

operational anomalies were encountered.

2. A propellant supply system consisting of all those components necessary to generate and store the propellants prior to introduction into the rocket engines was fabricated and tested. The tests indicated that the three different types of supply systems — blowdown, repressurized, blowdown, and oxygen repressurized — would supply adequate propellant to meet the specified mission objectives.

3. The 5.0 lb thrust GO_2/GH_2 engine which attained 69,000 firings in a boilerplate version prior to failure demonstrated its capabilities to provide high specific impulse, repeatable impulse bits and 100% ignition reliability at a 3 to 1 blowdown ratio. †

4. The 0.1 lb thrust GO_2/GH_2 engine accumulated 150,000 ignitions and the performance data indicated a high specific impulse, repeatable impulse bit, and 100% ignition reliability at a 3 to 1 blowdown ratio. †

5. For the mission/system analysis and flight-weight system design studies conducted, the water electrolysis system was 27% lighter than the monopropellant system and 6% lighter than the earth storable bipropellant system. . .”]

4) J. Doher et al, “Emulsions as Fuels”, *Mech-Engrg* **98** (11), 36–41 (1976) & *CA* **85**, 179933 (1976) [Irradiation of coal/w/oil with ultrasound produces an emulsion which is reported to have twice the burning rate of the coal or oil constituents by themselves, and has vastly improved combustion characteristics. This investigation showed that the emulsion exists in drops of 1000 micron diameter which can be reduced by addn of 10% surfactant to the emulsion mixt. Further, the emulsion drops expld violently when burning into small high velocity fragments in the order of microns in size which, in turn, also expld into smaller fragments. This action is attributed to the rapid vaporization of the w content which serves to violently fragment the emulsion into micron size particles, which are then rapidly burned] 5) D.E. Pawlak & M. Levenson, “Deflagrating Propellant Compositions”, *USP Applic* 128443 (1978) & *CA* **90**, 89639 (1979) [The inventors suggest that blending w into the invented compn makes the

proplnt safer to handle and manuf, and addnly increases efficiency over prior art compns. Thus, the proplnt is prepd from fine K nitrate (45), powdered charcoal (9), powdered S (6), K perchlorate (19), Na benzoate (11), dicyanamide (6), dextrin (4), w (12), micronized $\text{N,N}'$ -ethylene-bis (stearamide) wax (0.5) and graphite (0.5 p). The inventors report that an 80-grain charge of the proplnt gave a peak pressure of 7837psi compared to 10868psi for BlkPdr, and imparted a vel of 1795ft/sec to a 176-grain bullet (measured 5 ft from the muzzle) compared to 1657ft/sec for the BlkPdr] 6) E. Tuswald, “Liquid Fuel for Combustion Engines”, *GerP* 2814405 (1979) & *CA* **92**, 113321 (1980) [The inventor claims that when both w and gasoline (stored separately) are passed thru an ultrasonic field, a single-phase liq is formed which can be used as fuel in an internal combstn engine]

Water Explosives. Expls formed from the gaseous products of the electrolytic decompn of w, ie, hydrogen and oxygen. A survey of the patent literature (Refs 1, 3 to 5) indicates that the basic concept consists of enclosing up to several liters of w, previously made conductive by the addition of a small amt of alkali, in a thick-walled steel ctge, sealing the ctge, placing it in a mine borehole, passing sufficient current to decomp the w (requiring a time lapse of up to days), and then detonating the expl mixt by means of an electric spark. For a typical example of such “explosives”, see in Vol **8**, O5-R under “Ochse’s Cartridges”

In considering these expls, M. Berthelot made the following comment in the introduction to his book (Ref 2): “. . . Explosive mixtures (Melange tonnant) formed by hydrogen and oxygen renders, at equal weight, power superior to any other mixture known. Unfortunately, the original volume occupied by the explosive per unit weight is enormous, on account of the gaseous state and this does not allow the development of high pressures on explosion. Besides, the gaseous state of the original mixture requires the use of hermetically closed containers so that the gas would not be lost . . .” To this may be added several other negative points, viz, in order to achieve any success with this type of expl system, the original pressure in the ctge must be

† high specific impulse is specified as “up to 350 seconds”, and low impulse bit capability as “ 4×10^{-5} lb-sec”

high (from several hundred to over a thousand atms). At this juncture the procedure becomes hazardous because of the possibility of the premature rupture of the ctge. To overcome this eventuality, the ctges must be thick-walled and made of high quality steel. The latter point makes the system very expensive

Refs: 1) G. Preisenhammer, BritP 3377 (1861)
2) M. Berthelot, "Explosives and Their Power", Murray, London (1892) 3) F. Ochse, FrP 234437 (1893) 4) L. Carillon, FrP 238973 (1894) 5) J. Cornara, BritP 30253 (1897)
6) Daniel (1902), 233-34

Water-Pyrotechnic Reactions. See in Vol 8, M150-R to M252-L under "Moisture", and the following *Addnl Refs:*

Ignition and Combustion. A.V. Vasil'yev et al, "The Effect of Certain Additives on Critical Diameter and Combustion Rates of Mixtures of Aluminum with Gelled Water", **FSTC-HT-23-1509-73** (1974) (ADA 000210) [As a result of their work these investigators reached the following conclusions: a) Addn of 1 to 5% Li, Na, K or Al fluorides to a std stoichiometric Al plus w mixt increases its ignitibility and decreases the critical diam of combstn at atm pressure; b) The w-solubility of these additives is important, as the highly w-sol Na and K fluorides showed a greater effect on ign and combstn processes of the mixt than the slightly w-sol Li and Al fluorides; and c) The oxide film on the Al particles is vigorously removed by the action of the hot aq solns of both Na and K fluorides, allowing for the increase in combstn rate]

Uses. 1) W.L. Ripley & L.A. Smith, "Pyrotechnic Signalling Device Having Water Reactive Igniter", USP 3537397 (1970) & CA, not found [The inventors suggest a w-reactive ign compn for use in a Naval pyrot signalling device contg a quantity of pyrot compn for the production of smoke or flame. The igniter compn is in a thin-walled Al container sealed at the top with asbestos paper, the bottom of the container being intimate to a starter compn which is next in the pyrot train assembly. The inventors claim operation with either fresh or salt w, or by w-immersion by simply peeling off the Al seal of

the item and placing the entire pyrot item in w, which then soaks thru the asbestos paper. Thus, Na peroxide (35 to 55), ferrosilicon (20 to 50) and powdered Al (10 to 25 wt %) are mixed together, dried and sealed in the described capsule. Claimed autoign temp for the compn is ign after 5 secs at 324°; electrostatic sensy is "no fire" at 0.18 joules; friction sensy is "no fire" at 7500ft-lbs; impact sensy is "no fire" at 150 kg-cm; there is no reaction to 80% RH after 4 hrs exposure, and the thermal output of the compn is 950cal/g] 2) A.J. Tullis et al, "Development of Water-Ignitable Pyrotechnic Compositions", Proc7thSympExplosPyrots, III-4-1 to 12 (1971) & CA 76, 156283 (1972) [The development of a w-ignitable B-AgF₂-molecular sieve pyrot formulation is reported. Since near stoichiometric mixts of B and Ag difluoride have explded, a mixt of B (8), Ag difluoride (82) and molecular sieve material (10 wt %) has been found to be moderate enough for pyrot purposes. When made up into a pellet of 0.794cm diam x 1.27cm length, freshly prepd compn was found to ignite within 220msec after reaction with w, and burn at the rate of 1.14 cm/sec. However, after storage for 24 hrs at RT, a delay of 200msec was shown on activation, with a subsequent burning rate of 0.88cm/sec. A prototype w-activated detonator device was then designed in which the compn's performance is independent of temp, pressure, or amt of w required to activate

Water Pollution Caused by Munition Manufacture. See in Vol 8, P317-L to P324-L, under "Pollution Abatement in the US Military Explosives and Propellants Manufacturing Industry"; N85-R to N86-L, under "Nitration"; and under subtopic "Disposal of Waste TNT" in article on "TNT" in Vol 9

Waterproofness Test. The following test is contained in "Military Standard-Fuze and Fuze Components, Environmental and Performance Tests for", MIL-STD-331A (15 Oct 1976). This standard establishes uniform environment and performance tests for use in the development and production of US fuzes and fuze components. Its purpose is to provide engineering in-

formation on the performance of a development or production test item under natural and induced environmental conditions of military operations

In the interest of accuracy, this procedure will be reproduced verbatim:

TEST 108 WATERPROOFNESS

1. PURPOSE.

The waterproofness test is used during development of fuzes to check the ability of the fuzes to withstand submersion in shallow water.

2. DESCRIPTION OF TEST.

2.1 This test consists of subjecting bare fuzes to immersion for one hour in a water solution of sodium fluoresceinate (uranin) under a pressure of approximately 15 pounds per square inch (psi) gauge at 70°F, and subsequently examining the disassembled fuzes for evidence of water entry.

2.2 When specified by the design agency, all fuze explosive elements shall be present in the fuze during the test.

3. CRITERIA FOR PASSING TEST.

3.1 There shall be no evidence that any water has entered the fuzes.

3.2 The fuzes must be safe and operable following this test.

3.3 Breakdown, inspection and examination under ultraviolet light together with engineering judgment, are usually the basis for the decision.

4. TEST EQUIPMENT.

4.1 The equipment required to conduct this test includes a pressure vessel capable of withstanding safely the applied pressure and of sufficient size to accommodate enough water to completely cover all types of fuzes to be tested.

4.2 If fixtures are used in the vessel to hold the fuzes in particular orientations, the design of the fixtures shall be such that entrance of the water solution into the fuzes will not be impeded and that the fuzes will be completely submerged.

4.3 A source of pressurized air, water, or similar medium connected to the pressure vessel and controlled to raise the pressure at the fuzes to 15± 1 psi gauge is required.

4.4 Suitable instrumentation, such as a pressure gauge or manometer, shall be connected to the vessel to indicate the pressure acting on the

fuzes. A temperature indicator shall be provided.

4.5 A water solution of 0.2± 0.1 percent sodium fluoresceinate (uranin) by weight is required.

4.6 An ultra-violet light is required to examine the disassembled fuze.

5. TEST PROCEDURE.

5.1 The temperature of the fuzes and water solution shall be stabilized at 70°± 10°F prior to the start of this test and maintained within this temperature range throughout the test. Place the bare fuzes and water solution in the vessel so that the fuzes are completely surrounded by and in intimate contact with the water solution. To aid in the elimination of entrapped air, fixtures may be used.

5.2 Increase the pressure inside the vessel until the pressure at the fuzes is 15± 1 psi gauge. Maintain this pressure for 60± 5 minutes.

5.3 At the end of the immersion period, release the pressure within the vessel and remove the fuzes. Wash the exterior of the fuzes thoroughly in clear running water for about two minutes. Then dry the fuzes with a clean dry cloth.

5.4 Disassemble each fuze and inspect the components for conformance with 3.

6. RELATED INFORMATION (not a mandatory part of this test).

6.1 This waterproofness test is effective in determining whether the design of the fuze is adequate to withstand conditions of submersion which might be encountered, for instance, in a flooded magazine or a beach operation.

6.2 The characteristic color of a wet fluorescein stain under ultraviolet light is a bright yellow. Care must be exercised not to confuse this stain with many oils which also appear yellow under ultraviolet light. Most metals have a bluish cast under ultraviolet light. Plastic materials under ultraviolet light vary in color but have little or no tendency to appear yellow.

6.3 Examination of the disassembled fuze under ultraviolet light is improved when other light is excluded. The salt stain is persistent but must be moist when examined. If the components have dried, a water atomizer may be used to moisten salt deposits which may be present.

Water Resistance of Commercial Explosives. In the USA the following method for testing of water resistance of commercial expls is employed:

Sixteen regularly spaced holes (approx 6mm in diameter) are cut in the paper cartridge (30mm in diameter, 200mm in length) of the expl to be tested, and the flaps on the front faces are sealed with tallow. The cartridges thus prepared are placed in a flat, porcelain-enameled dish, covered with a thin layer of sand, and water at 17–25°C (63–77°F) is poured over the sand layer up to a height of about 25mm. The cartridges are left under water for a certain period of time, are then taken out, the seal is cut off at one end, and the cartridge tested for detonation and propagation with a No 6 blasting cap. The criterion for the water resistance of the expl is the time of exposure to water, after which it still retains its capacity to detonate the cartridge in three trials, without leaving any non-detonated residual expl behind. There is no generally accepted quality classification. Nevertheless, water resistance of an expl is considered to be satisfactory, acceptable or poor, if the cartridge can still be detonated after 24, 8 or 2 hours under water exposure, respectively

In Ger, the following method for testing the water resistance of powdery permissibles has been established at the Test Station at Dortmund-Derne:

A train of four cartridges is arranged in a line on a wooden board. The first of the four cartridges is fitted with a No 8 detonator. Five longitudinal, 2cm long notches, uniformly distributed over the circumference, are cut into each cartridge. The train is immersed for 5 hours in water, in a horizontal position, 20cm under the water surface, after which they are detonated. The train must detonate in its entirety

Refs: 1) R. Meyer, "Explosives", Verlag Chemie, NY (1977), 315–16 2) Anon, *Blasters' Hndbk* (1977), 32, 49 & 74

Water Stemming. See under "Stemming" in Vol 9

Watervliet Arsenal. Located at Watervliet, New York, 154 miles north of New York City. A

National Registered Historic Landmark and the nation's oldest arsenal, it was established in 1813. Its first mission was to supply arms and materiel to troops fighting the British on the western and northern borders of New York. The principal products were ammo, harnesses, and gun carriages. The years following the War of 1812 brought rumors of closing, but the Arsenal endured. Constructed between 1817 and 1824, the Erie Canal, passing thru the Arsenal, provided transportation, power for the shops, and water for fire protection, and greatly enhanced the Arsenal's value to the War Dept. In subsequent years the Arsenal expanded and several new buildings were constructed, including the Commander's quarters and a large limestone barracks, still in use. During the Civil War the Arsenal proved itself extremely versatile and responsive, dwarfing all previous production efforts. Not only were immense quantities of small arms and artillery ammo produced, but also gun carriages, scabbards, saddles, cap pouches, cartridge boxes, lariats, and nosebags and brushes for horses. After Appomattox the Arsenal faced lean years as activity dwindled to little more than storage. In 1887, the Arsenal was revitalized with its selection as the "Army Gun Factory", and construction was soon under way to convert it to cannon production. When the Spanish-American War began in 1898, Watervliet Arsenal produced the nation's first 16-inch gun. The beginning of WWI again brought substantial growth in buildings, roadways and equipment. But with the end of the war, there followed another lull in activity. Between 1935 and 1938, employment averaged about 350, and only 90 guns a year were produced. Then, in 1939, the Arsenal responded to the still far-off rumblings of WWII – the shops began to hum and an apprentice school was reactivated. Following the war, the Arsenal assumed a major role in research and development of cannon, mortars, and recoilless rifles to complement the manufg mission. One of the Arsenal's first efforts was the design of the 280mm atomic cannon. The long range 175mm and 155mm artillery cannon and the 105mm tank cannon were developed in the following decade. In the 1970's came the 152mm gun launcher, the lightweight 60mm mortar and a new 8-inch gun/howitzer. Thru-out this 30-year period the Arsenal was also

heavily committed in support of the Korean and Vietnam conflicts

Watervliet's current mission involves engineering, procurement, production, and product assurance of cannon, mortars, and recoilless rifles. In the event of mobilization, the Arsenal would provide designated producers with the expertise and equipment required to fulfill their assignments, as well as to serve as the interim producer until private industry can meet the demand. The Arsenal is the only facility in the free world capable of making guns ranging from 20mm to 16 inches in bore diameter, and up to 70 ft in length. No comparable product is produced by private industry, nor are the peculiar rifling, step threading, swaging and other machines duplicated anywhere in the government or private sector. Facilities designed exclusively for cannon manufacture are installed below ground level for chrome plating, thermal soaking, shrinkage and autofrettage. Highly specialized lab facilities are available to test guns at extremely high pressures. These tests sharply reduce the number of cannon that require live proof firing at the proving grounds. Natural geological features of the land are particularly suitable for construction of pits, crane systems, and buildings. The rock substratum forms a solid base, thereby eliminating stability problems

Watervliet Arsenal currently covers an area of 140 acres, contains 103 buildings with 2,200,000 sq ft of space, and employs 2700 personnel
 Ref: Anon, "Watervliet Arsenal" brochure, US Army, Watervliet Arsenal, Watervliet, NY 12189 (1978)

WAXES - USE IN ENERGETIC MATERIALS

Waxes, as the term applies to materials used in expls and related items, are not only those materials chemically defined as waxes but includes a variety of other materials which have some of the physical characteristics of waxes. The "original" wax is that material which makes up the honeycomb found in beehives, called beeswax. Other materials having characteristics somewhat like beeswax are also termed waxes. Chemically waxes are defined as the esters of high molecular

weight alcohols with high molecular weight fatty acids. The alcohols in wax molecules are normal ones having carbon chains ranging in number from 16 to 36 or are sterols (unsaturated secondary alcohols, ie, cholesterol). The acids of the wax molecules also generally range from C_{16} to C_{36} . As can be seen from the chemical analysis of beeswax (Table 1), waxes are not pure comps but complex mixts. The principle constituent of beeswax (about 23%) is myricyl palmitate. Other waxes found in nature are derived from animal, insect, mineral/petroleum and vegetable sources. Most abundant are the waxes obtained from mineral/petroleum sources. These waxes consist primarily of long chain hydrocarbon comps

Generally waxes are relatively non-reactive stable substances compatible with both organic (expls and proplnts) and inorganic (pyrot and composite proplnt) materials and their containers. They are not easily affected by oxygen. In most applications it is the physical properties of the wax which dictates its use. The waxy substances are plastic solids which are relatively easily deformed and readily cold flow. They form continuous films which are moisture barriers. Melting temps, because waxes are mixts, are quite broad and are relatively low. For US ammo the minimum melting temp of waxes used is generally 71° or very close to it. This is the upper limit to which ammo must be capable of being stored (part time) without being degraded (Ref 78). The British use about 1% beeswax in some of their 60/40 RDX/TNT mixts (Ref 116). Typical melting range for beeswax is 62° - 70° . US experience in investigating this wax in Comp B resulted in excessive exudation when expl loaded 105MM shell are subjected to storage at 71°

There are two very broad categories of waxes - natural and man-made or synthetic. The line of demarcation between the two is not sharp. In some reports waxes are referred to as "synthetic" if they are fractionally distilled from petroleum and the specific portions (identified by their melting ranges) are reblended. Table 2 lists the sources and examples of the more prominent natural waxes together with an indication of those waxes that have been used in conjunction with expls and expl related items. Some pricing information is also included

Table 1
Chemical Composition of Yellow Beeswax (from Ref 59)

<u>Esters of wax acids</u>		71%
myricyl palmitate	23%	
lacceryl palmitate	2%	
myricyl cerotate	12%	
ceryl hydroxypalmitate	8-9%	
acid esters	4-4.5%	
diesters	6-6.5%	
acid diesters, triesters, hydroxdiesters	3-3.5%	
myricyl hypogaeate.	12%	
<u>Cholesteryl esters of fatty acids</u>		1%
cholesteryl isovalerate		
<u>Coloring matter</u>		0.3%
1,3 dihydroxyflavone		
<u>Lactone</u>		0.6%
w-myristolactone		
<u>Free alcohols</u>		1-1.25%
<u>Free wax acids</u>		13.5-14.5%
lignoceric acid	1-1.5%	
cerotic acid	3.8-4.4%	
montanic acid		
melissic acid	2%	
psyllic acid	1.3-1.5%	
hypogaeic acid	1.5%	
<u>Hydrocarbons</u>		10.5-13.5%
pentacosane	0.3%	
heptacosane	0.3%	
nonacosane	1-2%	
hentriacontane	8-9%	
melene	2.5%	
<u>Moisture and Mineral Impurities</u>		1-%

for comparative purposes. Natural waxes are found universally. For example, a thin coating of wax exists on the exterior surface of apples. This coating, which accounts for the high shine when the apple is rubbed, protects the fruit from dehydration in that it forms a vapor barrier around the surface of the apple

All natural waxes are subjected to refining processes before utilization (purification, distln, oxidation, bleaching, etc). A brief description of the sources and general chemical makeup of some of the more important natural waxes listed in Table 2 follows

Animal Waxes

Wool wax is derived from wool-bearing animals. In its purified state it is called lanolin. Chemically it consists of esters of cholesterol and lanosterol and a high proportion of branched-chain acids containing both even and odd numbers of carbon atoms, together with both normal and branched hydroxy acids. Straight-chain, high molecular weight esters make up only a minor part of the wax.

Spermaceti wax comes from cavities in the head of the sperm whale. It is white, shiny, crystalline, brittle and greasy. The main constituent of this wax is cetyl palmitate and free cetyl alcohol

Table 2
Natural Waxes

<u>Source</u>	<u>Designation</u>	<u>Price*, \$/lb</u>
<i>Animal</i>	Wool wax (Lanolin)	0.78
	Spermaceti	—
<i>Insect</i>	Beeswax**	2.80
	Chinese insect wax	—
<i>Mineral</i>	Montan**	0.54
	Ozokerite	—
<i>Petroleum</i>	Paraffin wax**	0.31
	Microcrystalline**	0.41
<i>Vegetable</i>	Candelilla**	1.73
	Carnauba	1.90

* Chemical Marketing Reporter 11-17-80
average price

** Used in expl ordnance systems

Insect Waxes

Beeswax is the most important of the insect waxes. As mentioned above it comes from the honeycomb found in beehives and consists primarily of the palmitic ester of myricyl alcohol (see Table 1 for complete chemical analysis). *Beeswax* resembles the microcrystalline/paraffin waxes derived from petroleum. It is noted for its plasticity, ductility and its ability to form stable emulsions

Chinese insect wax Insects (*Coccus ceriferus*) in Asia secrete this wax on branches of ash and evergreen trees. The wax is scraped off and refined. It is composed of cerotic acid ester of ceryl alcohol with some free alcohols and hydrocarbons

Mineral Waxes

Ozokerite wax occurs naturally in the ground (wax shales) along with petroleum. It consists of high molecular weight aliphatic hydrocarbons. It is noted for its ability to absorb and hold oils and other additives (see Vol 8, 063-R)

Montan wax is considered as a semimineral, intermediate between the vegetable and mineral waxes. It is extracted from brown coal or lignite. Chemically it consists of esters of wax acids,

free wax acids, free wax alcohols and resins. *Montan waxes* are extremely hard and brittle, similar in these characteristics to the carnauba waxes (see Vol 8, M156-L)

Petroleum Waxes

The largest single source of hydrocarbon waxes is from petroleum. These waxes are a byproduct of the gasoline/oil refinement process. Petroleum waxes are divided into two main groups, paraffin waxes and microcrystalline waxes, both of which are hydrocarbons

Paraffin waxes consist of long straight chain saturated hydrocarbon molecules having a relatively small amount of branched chains. The number of carbon atoms range from 18 to 32 with molecular weights from about 350 to 420. The waxes are obtained through fractional distln of crude oil with subsequent separations from lubricating oil. On solidification, paraffin waxes form large, distinct crystals of plate and needle types (see Vol 8, P6-L)

Microcrystalline waxes consist of some long straight-chain saturated hydrocarbon molecules similar to paraffin waxes, but in addition have a larger proportion of branched-chain molecules. The average molecules have 40 to 50 carbon atoms and a molecular weight from about 490 to 800. Microcrystalline waxes are obtained from dewaxing and deoiling processes and from the settlings of tanks holding crude oil. Microcrystalline waxes form, as the name implies, small, indistinct crystals on solidification. This material tends to hold or retain oil, similar to the ozokerite waxes, while paraffin waxes do not

Vegetable Waxes

Candelilla waxes (grass wax) come from the leaves of a Mexican shrub, *Euphorbia anti-syphilitica*. It consists of about 65% hydrocarbons and alcohols, and about 35% wax esters and acids

Carnauba wax (Brazil wax) comes from leaves of the *Copernicia cerifera*, a South American palm tree. It melts at about 185° – 195°F, and is the hardest and toughest of the natural waxes. It consists mostly of all cerotic acid ester of myricyl alcohol

There are several US Government specifications covering waxes used in connection with expl ordnance. The most widely used of these is specification MIL-W-20553, entitled "Desensitizing Wax". It covers waxes which are directly incorporated with expl materials to reduce their mechanical sensitivity. In the past the same wax was used both in press loaded compns and in TNT based cast compns. The present specification covers one grade of wax. Specification requirements for this wax are primarily limitations placed on its physical characteristics. Wide ranges of waxy materials can meet these requirements and still not be acceptable for the intended application. The specification requirements were derived from specific waxes that have been proved to be satisfactory through utilization. In order that a wax be accepted, not only must the specification requirements be met, but compatibility and usage tests must be passed (see MIL-W-20553D and Ref 92). Accepted waxes, identified by their commercial designation, are placed on a Qualified Products List (QPL). As old sources of specific waxes become depleted, new waxes have to be found (See also below under "Analytical Aspects Specification Requirements" Section)

A list of US Government wax specifications include but are not limited to the following:

<u>Number</u>	<u>Title</u>
VV-W-95A	Wax, Paraffin, Technical
JAN-W-181	Wax, (Candelilla)
MIL-W-10842	Wax, Microcrystalline
MIL-W-10885	Wax, Impregnating, Waterproofing, for Laminated Paper Tubes for Small Arms Ammunition
MIL-W-12062	Wax, Petroleum
MIL-W-12598	Wax, Microcrystalline, Impregnating
MIL-W-13945	Wax, Hydrocarbon
MIL-C-18164	Composition D-2
MIL-W-20553	Wax, Desensitizing

Review of the materials covered by the specifications will indicate that all of the waxes are refined processed natural products and almost all are derived from petroleum. The reasons for this lie in two areas. First, in the past there was a very large supply of the basic materials, readily available at low prices. Second, these

materials performed satisfactorily. Periodically, specific sources and blends of waxes were depleted. Efforts then to develop alternate sources were successful (Refs 60 & 61). Early in the 1970's, however, there were, as a result of a general depletion of domestic petroleum supplies and changes in both basic raw materials and processing techniques, shortages of specific types and grades of waxes. Extensive search this time indicated that Grade A wax (formerly the better of the two grades of waxes covered by an earlier revision of specification MIL-W-20553) was no longer available in the quantities required [approx 1.5 million pounds of this wax was used annually - 1973 - for the production of Comp B (Ref 87)]. The problem of the shortage was resolved by using a less desirable wax, one not meeting all the requirements of the then existing specification

Of concern in the utilization of a variety of different waxes is their relative effectiveness in desensitizing expls as intended. Do all waxes used desensitize to the same degree? Ordnance systems are becoming more sophisticated and demanding. Systems are being designed much closer to maximum conditions that can be tolerated safely. For example, the launching forces (acceleration, setback and rotational) on projectiles and their contents are becoming greater so that the projectile can reach more distant targets. This requires more precise control over all materials and assemblies involved in the system, especially the expl charge. Most, if not all natural waxes vary considerably in their chemical makeup. This can and does lead to subtle changes detrimental to the operation of the system calling for the use of a desensitizing wax. Because of this, a shortage of waxes used previously, and the need for periodic qualification of waxes, work is continuing in attempting to develop satisfactory truly synthetic "waxes" for the various uses in expl ordnance. This concept is not new. Examples of these waxy materials in present day use, mainly as desensitizers, include:

<u>Material</u>	<u>Specification/Source</u>
Stearic Acid	MIL-S-271
Calcium Resinate	MIL-C-20470
Calcium Stearate	JAN-C-263
Polywax 655	Petrolite Corp, Bareco Div
AC-656 Polyethylene emulsion	MIL-C-63218

It is thought that man-made or synthetic waxes can be more precisely described both chemically and physically to assure that the same material can be procured for use time after time. It would only have to be qualified once. The man-made waxes obviously have the common physical characteristic of being waxy. Some are very similar chemically to the natural waxes and all usually involve long chain carbon molecules as their basic structure. Table 3 is a listing of the families of man-made waxes together with examples of commercial products. It goes without saying that synthetic waxes are going to cost considerably more than the natural waxes used in the past. The era of being able to use cheap desensitizers of the waxy type is drawing rapidly to a close. Most likely the basic starting material will still be mineral or petroleum (or natural gas). This material will have to be processed to rearrange its chemical structure, which requires energy and equipment. Like most other materials, costs are escalating, the production of organic waxy materials being no exception.

Waxes and waxy materials are used extensively in expls and systems relating to expls. Characteristics of these materials which find use in expl ordnance are categorized as follows:

- 1) Desensitizing/Phlegmatizing
 - a) Pressed mix
 - b) Cast mix
- 2) Shock Attenuating
 - a) Nose pads (nonreactive, reactive)
 - b) Interior coatings
 - c) Gap tests
- 3) Binding/Lubricating
 - a) Aid in pelleting and extrusion operations
 - b) Reduce gun barrel erosion—small and large cal
 - c) Casting aid
 - d) Detonator cup drawing
- 4) Sealant
 - a) Protect reactive powders

- b) Dip coating on flares, dynamites
 - c) Matchsticks and pyrot compns
- 5) Fuel
 - a) As fuel in fuel/oxidizer compns (expls, pyrots, composite proplnts)
 - 6) Inert Simulant
 - a) Pressed
 - b) Cast

Desensitizing/Phlegmatizing

Initiation theory. It is generally accepted, as postulated initially by Berthelot (Ref 1), that most all initiation of expls by shock/impact/friction is a result of the transformation of the mechanical stimulus into thermal energy. This energy develops non-uniform heating within the expl in very localized areas known generally as "hot spots" (Ref 9). Ignition occurs when the "hot spot" reaches a critical minimum size and temp. The specific size and temp are dependent on the reactive material(s) involved and the existing physical conditions. Ignition results when the heat energy liberated by the thermal decompn or reaction takes place more rapidly than it is dissipated to its surroundings. In a strictly homogeneous system, propagation follows. However, in a non-homogeneous system, which is the normal situation, propagation on a microscopic scale must proceed, at least initially from particle to particle. Depending on the condition between particles, ignition may be impeded and die out (quenched); it may never even be detected except thru the use of sensitive laboratory instruments. If the reaction is not extinguished it may proceed to either a quiet burning or it could go thru a process known as deflagration to detonation transition (DDT), ending in a violent expln. Principle factors determining which of three — reaction extinguishing, quiet burning or violent expln — possibilities will occur are:

- 1) Type of reactive material involved
- 2) Density/Porosity
- 3) Degree of confinement
- 4) Quantity of material involved
- 5) Magnitude/type of activating stimuli

Primary expls such as Pb Azide almost always detonate when made to react. Only when unconfined minimal (less than 1 mg) quantities are involved does it decompose quietly. Materials like TNT, especially if unconfined in relatively

Table 3
Man-Made / Synthetic Waxes

<u>Chemical Classification</u>	<u>Example</u>	<u>Company</u>
Long chain polymers of ethylene	Polywax 655 * Epolene N * A-C polyethylene	Petolite Corp Eastman Chem Prod Inc Allied Chem
Long chain polymers of ethylene-oxide with dihydric alcohols $\text{HOCH}_2(\text{CH}_2\text{OCH}_2)_n\text{CH}_2\text{OH}$	Carbowaxes	Carbide and Carbon Chem Co
Halogenated hydrocarbons Chlorinated paraffins & naphthalenes	Chlorowax Halowax * Seekay wax	Diamond Alkali Co Union Carbide & Carbon Co ICI
IG Waxes Montan wax derivatives	Hoechst Waxes	—
Alkyl esters Polyhydric alcohol esters of 12-hydroxystearic acid octadecyl 12-hydroxystearate ethylene glycol monoester	Paracin 1	Baker Castor Oil Co
Fischer-Tropsch Waxes hydrocarbon waxes made from CO and H ₂	—	—
Hydrogenated Waxes hydrogenated castor oil, fish oil, cottonseed oil, etc.	Castor wax Cote Flakes	Baker Castor Oil Co
Polyethylene polyol fatty acid esters and derivatives	Carbowax 4000 monostearate	Carbide and Carbon Chem Co
<u>Specific Chemicals with Waxy Characteristics</u>		
Waxy ketones	Palmitone	
Synthetic esters	cetyl stearate	
Fatty acid amides & Amide derivatives	palmitamide stearanilide	
Imide condensation products	N-hexadecyl phthalimide	
Fatty alcohols	stearyl alcohol	
Fatty acids	stearic acid * 12 hydroxystearic acid	
Metal soaps	calcium resinate * barium resinate * calcium stearate * barium stearate *	

* Used in ordnance systems

thin layers, if ignited, will burn quietly. One very insensitive material, Amm Nitrate, exhibited the DDT in the Texas City, Texas disaster (Ref 107). The material detonated because of the very large quantity involved (self confinement), the confinement of the ship carrying the material, and to the presence of a fuel. The Amm Nitrate burned for hours before finally expldng

Proplnts (single and double base) are designed and used in applications where ignition results only in controlled burning. However, since these materials are basically high expls (Nitrocellulose, Glycerol Trinitrate), under specific conditions, they do detonate

Pyrots are mixts of fuels and oxidizers. The ignition and propagation of reaction mechanisms are similar to that discussed for expls and proplnts. The reaction rate and ability to detonate is dependent on the specific materials involved, their particle size, the intimacy of the mix and confinement. Because some pyrot mixes on reacting produce very little gas, it is very unlikely that detonation could ever be achieved. An example of such a mix is Al/ferric oxide or Thermit. In other mixes of highly reactive materials, Mg/K chlorate for example, detonation can readily be achieved

According to Ref 52, the development of hot spots which lead to ignition in reactive materials can develop as a result of:

- 1) Adiabatic compression of small quantities of entrapped gas
- 2) Friction (a) on confining surfaces, (b) on extraneous grit particles, and (c) by intercrystalline movement of the expl particles
- 3) Viscous heating of rapidly flowing expl as it escapes from between impacting surfaces

Ref 75 proposes shear as an additional mechanism for the formation of hot spots

Other theories of initiation, not based on the initial action of a hot spot, have been proposed. One of these, the tribochemical mechanism, postulates the direct breaking of chemical bonds without the conversion of the mechanical energy to heat. Reference 49 discusses this mechanism more thoroughly

Desensitizing Theory.

According to Ref 51, there are three general methods of desensitizing expls. They are:

- 1) By dilution
- 2) By addition of a less sensitive expl
- 3) By the addition of an energy absorber

It can readily be seen that dilution of an expl with any compatible inert non-gritty material will, if carried to extreme, render the expl insensitive. Generally, however, it is desired to achieve a specific level of insensitivity with the minimum quantity of diluent so that the output from the expl charge is affected the least

The second method of reducing the sensitivity of an expl is to combine it with a more insensitive expl. For example, the sensitivity of RDX is reduced by incorporating it with TNT. (ie, Comp B, Cyclotols, Octols)

The third method of decreasing the sensitivity of expls is by the addition of an energy absorber. One of the most efficient energy absorbers is wax or a waxy substance. They are the most widely used non-expl material used to desensitize expls

As early as 1892 (Ref 1) it was indicated that expl mixes with materials such as paraffin, vaseline, etc, which have a tendency to result in a softer material, are less sensitive to mechanical stimuli. Since that time many studies (Refs 42, 44, & 67) have been conducted by various investigators to determine how waxes accomplish the desensitization of expls

It is reported in Refs 42 & 67 that moderate quantities of waxy materials incorporated with such expl materials as HMX, RDX and PETN do not appreciably affect their initiation sensitivity, but do inhibit propagation to expln. Ref 67 further states that no relationship between the specific and latent heats of the desensitizers and its ability to desensitize could be found, and concludes that the desensitizer cannot be regarded merely as a thermal sink. This is somewhat in conflict with results of work in Ref 91, where it is reported that it has been "established firmly that the sensitivity of the RDX compositions decreases with increasing specific heats of the additives, and a solid desensitizer functions primarily by absorbing heat from local regions of initiation including any hot spots which arise from adiabatic compression of occluded gas"

At least part of the conflicting results may be due to two factors; one, the specific type and conditions used to evaluate the mechanical sensitivity of the samples and, two, the extent

and nature of the incorporation of the waxy material on the expl crystals. For example, Ref 44 indicates that extremely pronounced desensitization to impact resulted when a thin layer of wax is deposited on both hammer and anvil of an impact apparatus (Table 4). Ref 91 appears to state just the opposite wherein it is reported that "if the rate of heat transfer from the powdered RDX sample to the striker and anvil is decreased, the explosive becomes more impact sensitive." (No wax is used in these tests) (Table 5). This latter observation is in agreement with Ref 29

J. Eadie reported in Ref 71 that the shock sensitivity of HMX/wax compacts is found to decrease as the amount of the HMX surface coated with wax increased. This thus indicates that the shock sensitivity depends on the surface area of the reactive expl exposed to reaction products. Similar results were observed 20 years earlier and reported in Ref 26. The following is a quote from this Ref, "It was noted in the course of this work that the 'quantity of inert material' per se was not the important factor in the phenomenon of desensitization. As a matter of fact, it was the thoroughness with which the explosive crystals (PETN) were coated that appeared to be an important factor in desensitization." Table 6 contains the results of the impact sensitivity tests conducted on PETN-wax mixts where both the quantity of wax in the mix and the degree of coating on the expl crystal are taken into account

Table 4 (from Ref 44)

Explosive Material	Impact Sensitivity, cm, 50% ht *
RDX	31.5
RDX w/1.2% beeswax	39
RDX w/1.2% beeswax	72**

* 1.5kg wt

** Wax coated on striker & anvil

Table 5 (from Ref 91)
Effects of Insulators on Striker/Anvil on Sensitivity of RDX

Condition of explosive sample holder	50% Ht,* cm
Bare striker/anvil	74
5/0 flint paper on anvil	20
Flint paper grit removed	32
5/0 flint paper reversed on anvil (grit toward anvil)	16
Bond paper on anvil	28
Bond paper on anvil & striker surface expl sample in between	21
Same as above except used two layers	30
Sample between two pieces of copper foil 0.005 inch thick	84
Same as above except copper foil 0.010 inch thick	204

* ERL Bruceton No 12, 2.5kg wt

Table 6 (from Ref 26)

Material	% Wax	Degree of Coating *	Impact Sensitivity ** 2kg, cm
PETN	0	—	18-21
PETN/Albacer	9.2	poor	30
PETN/Acrawax	8.0	poor	29
PETN/Acrawax	8.3	fair	38
PETN/Acrawax	10.0	very good	74
PETN/Ba Stearate	9.1	fair	53
PETN/DNT	38.0	poor	23
PETN/Pentawax 286	10.0	poor	35
PETN/Pentaerythritol tetrastearate	5.0	good	53
PETN/Pentawax 177	8.1	excellent	74
PETN/Pentawax 177	13.1	excellent	100+

* as judged by microscopic examination using ultraviolet light

** Bureau of Mines Impact Machine, 2-kg wt

Eadie, in Ref 69, reports on a considerable amount of work done on the ability of beeswax and paraffin wax to remain coated on HMX surfaces when immersed in liq TNT. Thru measurements of contact angles, a technique used earlier on RDX/wax systems reported on by Rubin in Ref 23, it was determined that the TNT preferentially wets the HMX and the wax is stripped away. He concludes "that the most important property of a desensitizing wax is that it should be readily dispersed uniformly thruout the TNT phase." He also suggests that a better desensitizer for investigation for use would be a wax or substituted hydrocarbon having a low interfacial tension with TNT. The smaller the wax droplet size the more efficiently it will be distributed and the more effectively it should desensitize. Williamson (Ref 64) in his examination of the microstructures of PETN/TNT/wax fusion-casts detected that wax is dispersed thru the cast as isolated discrete globules which he refers to as "blebs" or irregular or streak-like areas, surrounded by TNT (see also Ref 54)

Ref 69 also examined the ability of waxes to coat HMX. Various techniques for assessing the degree of coating achieved were developed. It was determined that complete coverage was not achieved until approximately 10% wax was present. Sensitivity tests results indicated that neither the wax nor the coating method used had a significant effect, provided the coating method leads to good dispersion of the wax thruout the high expl

Use of Waxes in Explosives as Desensitizers (see also Vol 3, D88–D90)

Waxes are used in expl compns as desensitizers in three ways:

1) Coated on expl particles as in pressed compns, 2) Dispersed in more insensitive expl casts as in TNT based compns, and 3) In cast compns where the wax is the melted liq which carries the solid expl

As indicated above, paraffin wax, when incorporated with expls, is known, as early as 1892, to have reduced the mechanical sensitivity of the resulting expl compn. Most work in the US in investigating waxes for the purpose of desensitizing expls did not start until the late 1930's early 1940's. Most of the investigative

work in the desensitization of RDX had as its basis the British experience with their two expls, 91/9 RDX/beeswax and 40/60/1 TNT/RDX/beeswax. The 91/9, known in the US as Compn A, is loaded into munitions by mechanical consolidation. The 40/60/1 mix, called Compn B, is loaded into munitions by melting the TNT and pouring the resulting slurry into the projectile cavity. The same waxes are used in both of these two compns at least to the present time. What has been found to be satisfactory for one compn has, fortuitously, been satisfactorily for use in the other. Clear cut separation of discussion on press and cast loaded compns is not always possible. Although it is very convenient to deal with only one wax (or wax mix) at a time, especially in production, this does not necessarily have to be. It is entirely possible that a waxy material may be satisfactory for press loaded compns, but not for cast loaded compns, or vice versa. In investigating new waxy desensitizing materials possible use in either compn should not be overlooked. As much as possible the use of wax as a desensitizer will be covered in three parts, press loaded compns, cast loaded compns and cast loaded compns where wax is used as the vehicle. It should be noted that while the principle purpose of the wax is to desensitize, it does serve other roles in the compns such as a binder, lubricant, sealant, etc

Pressed Explosives

Composition A Type

There are two common types of standard press loaded expl compns used in US ammo. One contains waxy binder/desensitizing materials, while the other contains synthetic polymeric materials. Description of plastic bonded expls (PBX) can be found in Vol 8, P60–P77 and are not covered here

Most prominent of the waxed pressed expls, used extensively by the US Navy in their projectiles, is Compn A-3 (also used in Army HEP ammo). Ref 82 covers the history of the Navy's use of this expl (see also Vol 3, C474–C477 for additional information on Compns A-3, A-4 and A-5)

There have been various designations for the 91/9 RDX/wax compns. The first of these was

Compn A. This expl, developed by the British, is a mixt of RDX and beeswax. Subsequently, Compns A-2 and A-3 were developed and differed only from the original 91/9 RDX/beeswax in the specific wax or the process used in their preparation

In the early 1930's the British investigated the use of beeswax incorporated with RDX as a means of reducing the sensitivity of RDX to a degree where it could replace the standard fillers, Shellite (70/30 Picric Acid/2,4-Dinitrophenol), TNT and 93/7 TNT/beeswax, in armor piercing projectiles (Ref 105). Beeswax in the amounts of 2, 5, 7 and 9% with RDX were investigated. The compn containing 9% wax was selected as standard. Initial shell loading was accomplished by a screw-filling process. After a serious accident occurred in 1936 this process was abandoned in favor of the presently used press loading technique

The US became interested in a pressed RDX compn for use in projectiles in the early 1940's. In examining the 91/9 RDX/beeswax compn relative to the total quantities required, it was very evident that because of the limited availability of beeswax, a substitute for this wax would have to be found. The British also contemplated this same problem. They conducted investigations to find substitutes. The following is quoted from Ref 9 as a summary of properties of a beeswax substitute that would fulfill the British requirement. This information is reported to have been taken from Ref 118:

"Characteristics of Wax Substitute for Beeswax

- 1) Melting point not lower than 60°C.
- 2) It should adhere to the surface of RDX in the presence of water heated above the melting point of the wax.
- 3) It should be plastic and flow readily under high pressure.
- 4) It should possess an element of 'stickiness'
- 5) Mixtures of plasticizer and explosive should be free of exudates.
- 6) Unsaturated constituents are desirable to remove traces of nitric acid from RDX."

It was found that waxes based on long-chain alcohols were promising, esters gave promise if in a high hydrocarbon mixt, such as "apiezon grease" or the residue from the distln of vaseline was incorporated

Work initiated in the US was directed toward

the requirements stated in Ref 11. These included the following:

"1) The mixture with cyclonite (RDX) should possess an insensitiveness to impact at least as great as 91/9 RDX/beeswax.

2) The material should incorporate well with RDX from water.

3) The mixture with RDX should possess satisfactory chemical stability.

4) The mixture with RDX should have good pressing qualities.

5) The mixture should stand moderately elevated temperatures for long periods without excessive exudation.

6) The material should be cheap and readily available in large quantities."

The search for candidate beeswax substitutes was centered on the following five groups of materials:

- 1) Petroleum waxes
 - a) Paraffin waxes and other crystalline waxes
 - b) Amorphous waxes
- 2) Paraffin waxes plus additives
- 3) Other petroleum waxes plus additives
- 4) Synthetic and natural ester type waxes
- 5) Miscellaneous materials

Many waxy materials in the various categories covered above were evaluated. It was observed that two classes of materials stood out: 1) Paraffin waxes plus an active agent such as Alox, and 2) certain amorphous (microcrystalline) waxes with and without the addition of active substances. The results of tests indicated that the five best waxes of those studied in Ref 11 are those shown in Table 7

Two very important observations made in this report are as follows:

"1) The only reliable method for determining whether a material will withstand the shock of hitting armor plate is to load it into a shell and try it.

2) An ordinary paraffin hydrocarbon wax has considerable phlegmatizing action, but the molecules of this wax are so lacking in polarity that there is little attraction between them and the polar groups of the cyclonite (RDX), and hence the wax will not displace water from RDX". (without the aid of a surfactant such as Alox 600)

Ref 12 continues the evaluation of the waxes

Table 7 (from Ref 11)

Material	Producer
Petrosene C (mp 72°C) w/10% Alox 600	Socony Vacuum Oil Co
Moore & Munger #3009 Amorphous wax (mp 74°C) w/10% Alox 600	Moore & Munger
Essowax paraffin (mp 55°C) w/5% Alox 600 & 10% Piccolyte resin	Standard Oil Co
Stream 1 (mp 60-63°C) w/10% Alox 600	Union Oil Co
Stream 2 (mp 72-73°C) w/10% Alox 600	Union Oil Co
Alox 600	Alox Corp
Piccolyte resin SR-85 (mp 85°C)	Penn Industrial Chem Co

screened in Ref 11. These waxes were incorporated into 91/9 RDX/wax compns, and tested for exudation at 50°, corrosion of brass and steel, and loading and pressing characteristics. Results indicate that the beeswax substitutes are inferior to beeswax in their loading characteristics at room temps (they have good characteristics at elevated temps). Conversely, the substitutes exhibited no reactivity to brass and steel, whereas the beeswax expl showed a reactivity toward brass.

A most comprehensive report of the early work in the US on waxes for use in Compn A type expls is published as Ref 33. It covers all the work conducted on wax for use with RDX during the period of 15 Feb 1942 to 27 Dec 1945. Methods used in prepn, pelleting properties, sensitivity and stability characteristics of the 91/9 RDX/wax compns are discussed in detail. In addition exptl compns of RDX/wax/Al and RDX/wax/KNO₃ are briefly mentioned.

The 90/10 Aristowax 160-65/Alox 600, also known as Bruceton Wax No 10, was used thruout WWII. It was used in both Compn A and in Compn B. The Alox 600 used generally contains small quantities of resinous material insoluble in molten wax. The Alox 600 also is believed to be responsible for some of the stickiness and wax exudation of the Compn A. Recommendation was made to decrease the concn of Alox 600 from 10% to 1% in Wax No 10 to reduce these

undesirable characteristics. (see additional information on Alox 600 under "Waxes in Cast TNT Explosives" below)

Compns of 91/9 RDX/waxes were furnished by the National Defense Research Committee to PicArns for evaluation (Ref 13). Results of the investigation showed that the 90/10 Stream 2 (petroleum wax)/Alox 600 (a catalytic air oxidation product from petroleum) is a suitable substitute for beeswax for use in desensitizing RDX so as to make it suitable for use as a shell filler. Other waxes investigated and found acceptable (Ref 23) for use in conjunction with 10% Alox 600 include:

- Aristowax
- Be Square special wax
- Victory wax
- Stanolind wax
- Standard Refined wax

Characteristics of three of these waxes when tested to Specification JJJ-W-141 are shown in Table 8

Table 8 (from Spec JJJ-W-141)

	Aristowax	Stanolind	Standard Refined
Softening point, °C	63.5	74.5	70.5
Acid number	none	none	none
Volatile matter	0.04	0.18	0.05
Ash	none	none	none
Matter insol in CCl ₄	trace	none	none

In a search for a greater variety and more effective desensitizers, a study was undertaken to investigate commercially available synthetic waxes (Ref 26). The study was primarily to determine the effects of these inert materials on the stability and expl characteristics of the more sensitive expls. Of 17 materials examined, the following four were found promising in rendering PETN less sensitive:

- 90/10 Aristowax/Alox 600
- Aristowax 150-5
- Beeswax substitute 776
- Pentawax 177 (85/15 pentaerythritol/dipentaerythritol hexastearate)

A Swiss patent application (No 62314, USP application No 439767) for the material pentaerythrite tetrastearate, very similar to Pentawax 177, for use as a desensitizer of PETN was brought to the attention of PicArns. An investi-

gation of this material, covered in Ref 27, confirmed that indeed this material offers promise, but offers no special advantage over other desensitizers being studied

Ref 28 continues work recommended by Ref 26. Results of the work indicated the Beeswax Substitute 776 and Pentawax 177 are most promising. When as little as 2% of either of these two waxes are properly applied to PETN, the sensitivity of the resulting expl to impact is approx equal to that of Tetryl. It is further reported that when the PETN-wax compns are pressed to densities above 1.43g/cc, increase in the proportion of the wax in PETN-wax compns results in an increase in the rate of detonation which may be as great as 190m/sec. It is indicated that PETN-wax compns for use in detonators, boosters and pressed shell charges are competitive with RDX-wax compns. Fragmentation tests of waxed PETN containing 10 to 13% wax is recommended for direct comparison with Compn A

Because of a production problem involving the press loading of Compn A type expls, a project was initiated with the objective of finding suitable desensitizing waxes which could be incorporated with RDX which would produce a compn that would not stick to the loading tools. The original wax used in the US for the 91/9 RDX/wax compn was a 90/10 Aristowax/Alox 600. This wax was replaced in 1945 by microcrystalline waxes having higher melting points than the Aristowax. The Alox 600 content was reduced to 3%. Ref 38, the initial report of this series, contains results of tests made on the following three compns:

92/6/2 RDX/polyvinyl acetate (PVA)/
dibutylphthalate (DBP)

91/9 RDX/Santowax M

91/9 RDX/Be Square Special Wax

The compns containing the Santowax M (product of Monsanto Chemical Co; Santowax M is a meta-diphenyl benzene, a hard microcrystalline wax very stable to heat with a mp of 181-84°F) were found most suitable with respect to ease of manuf and non-adherence to punches and dies. They were more satisfactory than the standard Compn A-3. Both the Santowax M and the Be Square Special Wax coated the RDX crystals well; the polyvinyl acetate/dibutylphthalate did not. The PVA/DBP, during the RDX coating

operation, stuck tenaciously to the equipment. The 91/9 RDX/Be Square Special Wax (product of Bareco Oil Co, grade 190/195, is a high melting microcrystalline wax) was not as satisfactory as the Santowax M compn in pelleting tests and showed no superiority over Compn A-3

In the second progress report (Ref 39) the material Pentawax 177 (see Refs 26, 27 & 28) was evaluated as a possible replacement for the Compn A-3 desensitizer. It was concluded that a compn of 92/8 RDX/Pentawax 177 (designated Compn PSP-1) was very similar to Compn A-3 with respect to its expl characteristics, and adhered only slightly to metal parts when consolidated at pressures up to 12000 psi. It pressed to a higher density above 9000 psi than Compn A-3. Its pellets (prepd at 8000 psi) were considerably stronger than those of Compn A-3

Studies of the use of Pentawax 177 (Wax B) together with two other waxes - Wax A and Wax D - were continued and reported in Ref 43. Apparently Pentawax 177 could not be procured in the grade used previously (mp 70-73°C), only being available with a melting point of about 64°C. When shell loaded with Compn PSP-1 made with the lower melting Pentawax 177 were stored in surveillance chambers heated to 65°C, excessive exudation occurred. It was concluded from these studies that: "1) RDX/Wax A, 91/9, is unsuitable for press loading in small caliber shell; 2) the Pentawax 177 of lower melting point is not suitable for use in the RDX/Wax B compn because of exudation on storage at 65°C (since the higher melting Pentawax 177 was not available further evaluation cannot be made); and 3) Composition A-3 made with Wax D may be suitable for press-loading into small caliber shell."

Sixty-four waxes or waxy materials were screened for possible use in Compn A-3 type RDX mixes (Ref 47). Continuous pelleting tests in comparison with standard Compn A-3 (made with Stanolind 170/5 wax) were conducted. Four of the wax coated compns were considered comparable. The waxes used in these four compns were:

Mekon A-20	Warwick Wax Co
Crown 500	Tretolite Corp
Be Square Spec Wax	Bareco Oil Co
190/5 Amber	
Micris 1500 lemon	Commerce Oil Co

None of these waxes, including the standard, Stanolind 170/5, was entirely satisfactory. The addition of graphite to the compns, the use of some mold release compds, and a change to a chromium plated punch did not improve the pelleting characteristics

Another approach to eliminating the problem of adherence of standard Compn A-3 to the tools used to pellet and press load was thru the use of materials that serve as hiding agents, as well as lubricants. Eighteen materials were investigated and reported on in Ref 48. The most satisfactory materials found for this application were the metallic stearates (calcium, lithium, cobalt, zinc, chromium), and talcum powder. Also, a small amount of artificial graphite, added to the mixt during coating of the Compn A-3 with the pulverized material, was found to improve the ease and degree of coating by reducing the electrostatic charge of the powdered materials. Three compns of Compn A-3 and two of Compn A-4 were found to be non-tacky in lab scale pelleting tests. These compns contained about 98% Compn A-3 or A-4, 2% metallic stearate or talc, and 0.5% artificial graphite

Ref 55 expanded the studies aimed at eliminating problems involved in pressing Compn A-3. The objectives were to develop methods to prevent adherence of Compn A-3 to the tools during continuous pelleting, and develop non-tacky compns. Spraying the tools with water before pressing each pellet made it possible to pellet continuously without having the compn adhere to a harmful extent to the tools. The use of an antistatic agent, mold-release compds or Teflon-coated tools did not produce any significant improvement. No completely satisfactory desensitizer for use in Compn A-3 was found which would permit production of uniform pellets in continuous pelleting operations. Dusting Compn A-3 with Ca stearate reduced sticking of the compn to the tools somewhat when pellets were pressed to a density of 1.65 g/cc. At lower pellet densities the Ca stearate did not reduce this sticking

A new set of ideal characteristics for the desensitizing agent for use with RDX for producing Compn A-3 is contained in Ref 55. These characteristics are:

- 1) Produce no chemical reaction with RDX.
- 2) Produce a strong, flexible coating on the

granules of explosive.

3) Act as a binding agent during consolidation of the coated explosive in order that firm high-density pellets can be formed.

4) Produce a composition which does not stick, to any extent, to steel pelleting tools.

5) Be easily applied in a hot water slurry.

6) Be water insoluble, nonhygroscopic and neutral.

7) Produce a composition which does not exude or "sweat" at 160°F.

8) Produce a composition which does not deteriorate over long storage periods at temperatures as high as 160°F.

9) Be composed of materials readily available from domestic sources."

Approximately 18 commercially available waxes were investigated for possible use in Compn A-3 formulations (Ref 60). Based on the results of this investigation, Purchase Description PA-PD-535 (15 Sept 1954) was written defining, primarily in physical terms, acceptable waxes for use in Compn A-3. Two waxes, Sunoco 8810 and Sunoco X-10325 were found to comply with the requirements of this specification

In more recent years (mid 1970's) because of extreme shortages in the petroleum waxes, considerable work was accomplished by both the US Navy and Army in a continuing search for suitable desensitizers. It is fortunate that, in the past, the same waxy materials used performed satisfactorily in both pressed and cast expl compns

In the area of press loaded expls, work was conducted primarily by Floyd Hildebrant (see Refs 103, 104 & 111) for the Army. The objective of his work was to develop, evaluate and qualify synthetic desensitizer replacements for the standard Compn A-3 (microcrystalline waxes). Three specific families of waxy materials were investigated. These were:

- 1) Synthetic paraffins and polyolefins
- 2) Bisamide waxes
- 3) Acrylic latexes

It was determined that Adoarwax 225, one of the bisamide waxes, is chemically incompatible with RDX. This class of material was dropped from the program. Whether the incompatibility is typical of this family of waxes was not determined. Work on the acrylic latexes was discontinued when it was found that the result-

ing compn lacked required cohesion in the consolidated form

The following three candidates were selected from the family of synthetic paraffins and polyolefins:

- 1) R2-N3/H1-N3 Fisher Tropsch Wax (from coal)
- 2) AC-656 polyethylene (from natural gas)
- 3) AC-580 Polywax 500 synthetic paraffin (from oil)

Forty-five hundred pound batches, each, of modified Compn A-3 using the three different waxes were prepd. It is significant that the method used in their production was by an emulsion encapsulation technique. As part of this program, 400 each 105mm HEP-T M393 rounds were loaded and ballistically tested against standard Compn A-3. As a result, Compn A-3 made using AC-656 polyethylene was selected for further evaluation. All acceptance and safety certification tests were successfully completed. It is concluded from the evaluation of the materials produced that:

1) The emulsion encapsulation system is superior to the present production technique (hot water slurry technique).

2) Synthetic materials can be rapidly deposited onto the surface of RDX.

3) The characteristics of the modified Compn A-3's produced are an important improvement over the standard Compn A-3 with respect to:

- a) Bulk density
- b) Impact sensitivity
- c) Exudation at 160°F

Specification MIL-C-63218 covering the AC-656 polyethylene emulsion and the polyethylene coated RDX, designated Type II polyethylene in MIL-C-63217 for Compn A-3, was submitted for approval in the Cartridge, 105mm, HEP-T, M393A2 round

Along this same line of work, W.S. Wilson studied the prepn and sensitivity of RDX/emulsifiable polyethylene wax compns. His work is reported in Ref 109. The synthetic polyethylene wax (AC-629, Allied Chemical Ltd), already used in a compn of HMX and terylene

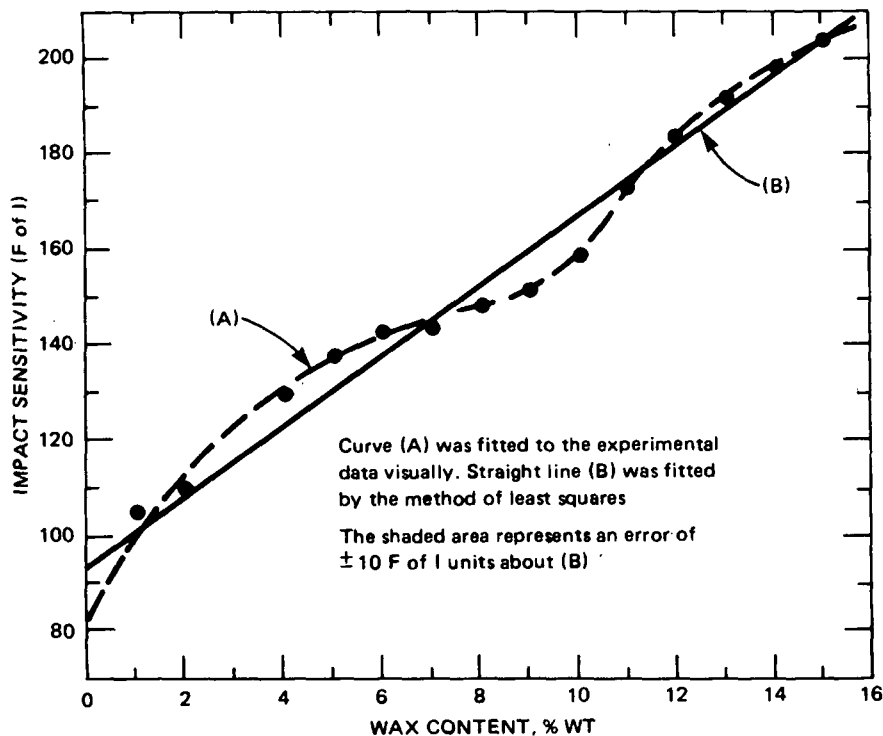

Fig 1 (from Ref 109)
Impact Sensitivity of RDX/Polyethylene Wax Compositions

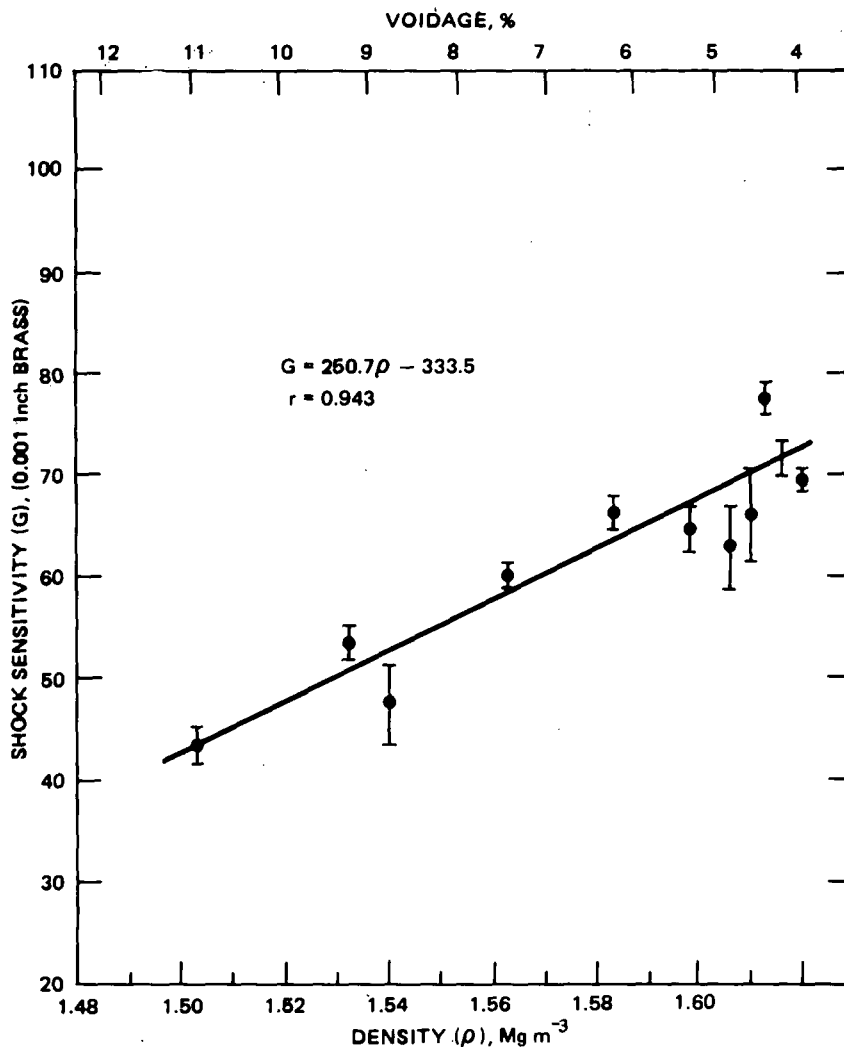

Fig 2 (from Ref 109)
Shock Sensitivity of RDX/Polyethylene Wax 92.5:7.5 as a
Function of Density

fiber (EDC 23 and EDC 24) at AWRE, Aldermaston, Engl, was used in an emulsion encapsulation technique to coat RDX. Comps varying in wax content from 1 to 15% were studied. The impact sensitivity of the comps with the various percentages of wax decreases almost linearly with increasing wax content. Fig 1 is a graphic representation of sensitivity vs % wax. The comps compacted readily with the "ease of pressing" markedly dependent on the wax content (see section under lubricants below). The shock sensitivity increases with increasing

density (Fig 2) and decreases with increasing wax content (Fig 3). The velocity of detonation decreases with increasing voidage or wax content

The US Navy made a concerted effort in the area of synthesizing waxes for use in desensitizing both cast and press loaded expls. Ref 102 is the first report in this series. This report covers the synthesis and laboratory evaluation of over 60 new waxes for possible use in expl formulations. Based on the results it was recommended that further scaled up synthesis of octadecyl terephthalate be conducted and that

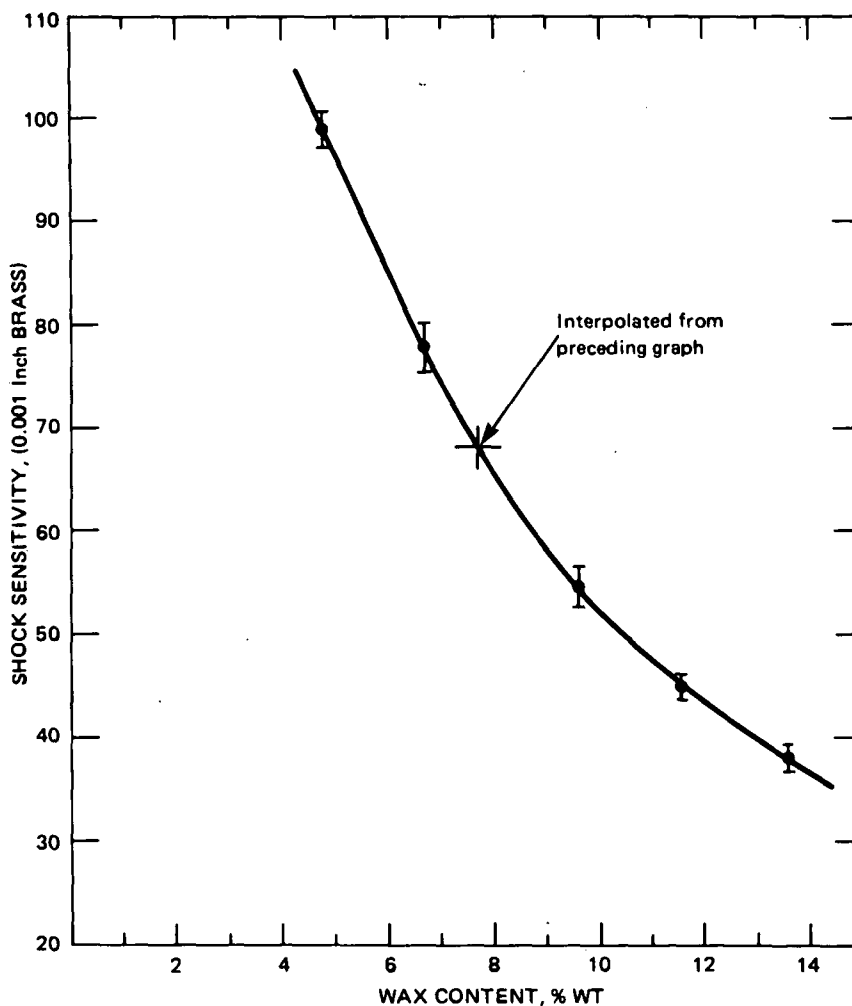

Fig 3 (from Ref 109)

Shock Sensitivity of RDX/Polyethylene Wax, pressed to 95.2% theoretical maximum density as a function of wax content

further synthesis and evaluation of aliphatic and aromatic carboxylic esters be conducted.

Other work was conducted by the Navy at Yorktown in the search for waxes. Ref 101 reports on the screening of 13 samples utilizing the differential scanning calorimeter, exudation behavior at 71°, compatibility with H-6 expl and incorporability in molten TNT. Three candidates selected for further testing were:

- Bis (octadecyl) terephthalate
- N-octadecyl-o-docosanyl carbamate
- 12-hydroxystearic acid

Results of further testing of these materials was unsatisfactory. The 12-hydroxystearic acid is exceptionally poor in the areas of increased viscosity of the H-6 slurry, poor wetting of the aluminum, brass corrosion, low melting point and high oil content. The N-octadecyl-o-docosanyl carbamate on temp cycling as H-6 fails to inhibit TNT sublimation. Its crystallization pattern and its subsequent effect on the crystn of the TNT in H-6 differs significantly from that of microcrystalline waxes. It has a high degree of friability and lacks flexibility. This brittleness

is expected to cause poor pressing characteristics in an expl such as Compn A-3. The sample of Bis (octadecyl) terephthalate was found to be significantly impure. The sample was not used

Modified Composition A Type/Others

Early in the 1940's it was desired to develop an insensitive castable high expl filler for use in armor piercing (AP) shell to replace the standard filler, Explosive D (Ref 16). Cast expls designated as APX-1A, -2A and -3A, all containing 8% aluminum resulted in improved fragmentation and incendiary effects as compared to Explosive D. Interest was generated in developing a pressable expl filler for this application. As a starting point Compn A with aluminum was investigated (Ref 21). Sensitivity to impact tests were conducted on mixts of CompnA/grade B Al with the Al content ranging from 0 to 70%. It was concluded from this work that mixes designated APX-4A and APX-5A (92/8 CompnA/Al and 87.4/4.6/8 Halite/wax/Al, respectively) offered improvement over Explosive D, and it was recommended that these two expls together with Compn A be tried in AP Shot, with and without nose pads, against armor plate

Ref 22 continued the basic work of Refs 16 & 21. Emphasis was placed on use of TNT/Al pellets in various locations in the shell, and on use of a TNT filler loaded in shell containing wax/Al nose pads. The functioning was compared with APX-1A (92/8 TNT/Al) and TNT. It was determined that a wax-Al nose pad produced better results and appeared to be more practical than the addition of TNT/Al pellets to the charge. Further armor plate impact tests with TNT loaded shell fitted with cast Al-wax nose pads were recommended. The compn of the nose pad of the TNT loaded shell was 80/20 Al/wax; the nose pad of shell loaded with 50/50 cyclotol was 90/10 Al/wax. The 80/20 nose pad was hand pressed into the shell because the higher wax content prevented granulation of the mix after it was heated and cooled. The 90/10 nose pad was pressed into the nose at 12,000 psi. It was felt that a castable pad using less than 30% wax was feasible. This could be premolded and then fitted into the nose portion of the shell. Although not specifically mentioned as being used in the nose pad, waxes used in the expl were either 90/10 Aristowax (mp 165°F)/Alox 600 or beeswax

There have been at least two other compns investigated as possible replacement/modification of Compn A-3 for AP shell filler requirements (Ref 82). One compn consisted of 88/12 RDX/wax and the other 68/12/20 RDX/wax/Al. Plate penetration test results, however, indicated that there was no difference in sensitivity of the 88/12 RDX/wax from Compn A-3. The aluminized compn was less sensitive than Compn A-3 but more sensitive than Explosive D. The aluminized compn exhibited increased reassertion — expansion of the consolidated charge — over that experienced in using Compn A-3. However, it still did not meet the plate penetration requirements. Further work on these compns was terminated

One test method, the Varicomp System, developed by the Navy (Ref 66), takes advantage of the ability of metallic soaps (calcium stearate) to desensitize expl compns in varying degrees depending on the specific quantity of soap used. The shock sensitivity of a series of these compns was determined in a gap test (Ref 80). Certain of these expl compns were substituted, in a proposed fuze system, for the more sensitive expl planned to be used. A small number of these models were test fired to determine the reaction of the surrogate expl. From its response statistical estimates of the reliability of the transfer of detonation to the normally used expl charge could be calculated. Use of this technique depends on knowing accurately the shock sensitivity of both the surrogate expl and the expl normally used under the conditions existing in the fuze — charge density, diameter, confinement, etc. Detailed discussion of the use of this technique is presented, together with other techniques for determining the safety and reliability of fuze expl trains, in Ref 108

Waxes in Cast TNT Explosives

Composition B (see Vol 3, C477—C484 & Refs 92 & 106)

The investigation of the use of RDX by the British in a castable mix was initiated in the early 1930's. As with the press loaded 91/9 RDX/beeswax compn, it was desired to use a desensitized castable compn in AP and Semi-Armor Piercing (SAP) shell. While the TNT did desensitize the resulting 60/40 RDX/TNT compn significantly, it was not rendered insensitive enough for this application. In attempts to

further decrease its sensitivity, 1% beeswax was added to the mix. This amount of desensitizer still did not render the compn suitable for use in AP or SAP ammo. Nevertheless, the 1% beeswax was retained because (Ref 105) "The beeswax was also claimed to assist the working of RDX/TNT and to reduce the amount of loose dust present in packing boxes and also to desensitize such abraded material." By 1940 RDX/TNT/beeswax 59.5/39.5/1.0 (Ref 7) was a standard fill for use in British HE shell, aircraft bombs and torpedo warheads

Work in the US on desensitized expls started in the early 1940's. The castable expls like the pressed expls were patterned after the British work. The US goal was to develop a substitute wax to replace the 1% beeswax in the RDX/TNT compn

The initial investigations in the search for substitute waxes are reported under the press loaded expls above, specifically Refs 11 & 12. Ref 14 covers the early work in the US on waxes developed (in Refs 11 & 12, for US press loaded expls) for RDX/TNT castable expls. It concludes in Ref 14, "that Wax # 10 is in every respect a suitable substitute for beeswax in the 60/40/1 mixture." The two compns (one containing 1% Wax # 10, the other with 1% beeswax) are compared for consistency, impact sensitivity and bullet impact. The expls have essentially the same characteristics. It is indicated that since the effects produced by the wax are relatively small, it seems very probable that other similar wax mixts will also be suitable. Wax # 10 is a mixt of 90/10 Stream 2/Alox 600, described under the press loaded compn section above (wax # 10 is the same as Bruceton Wax # 10 and Aristowax is the same as Stream 2, Ref 15). Alox 600 acts as a wetting agent. Results of investigative work showed that Alox 300, Alox L-1260 and Alox 702 are as good as Alox 600 but no better, and are more expensive (Ref 11)

Ref 15 is a comprehensive report covering details of the progress in the development of Compn B, the formal designation for the 60/40/1 RDX/TNT/wax mix, to 15 Jan 1943. This report, coupled with Refs 92 & 106, contain or refer to almost all the practical information pertaining specifically to waxes used in the US Compn B. Covered in Ref 15 is a thorough

study of the expl and physical properties of Compn B. Impact sensitivity, rifle bullet sensitivity, sensitivity to detonators, gap sensitivity, stability, detonation rate, ballistic mortar and brisance of Compn B are determined. Likewise, density, viscosity, settling rate of RDX, wax content and dusting characteristics are determined. Considerable work is also conducted in studying and establishing the phase diagram of the RDX/TNT system. Specifically there is no confirmation that the wax reduces the amount of dust formed from Compn B or that the dust formed is less sensitive than the dust from 60/40 RDX/TNT compn

Considerable time was spent on determining how much of the wax used in formulating Compn B is actually retained in the finished cast. This work, reported in Ref 15, involves developing methods of analysis, methods of incorporation of the waxes, and studying wax segregation from both molten TNT and molten Compn B. It is concluded from this work that the wax content remains fairly constant at about 0.7% of the mix. More recent (1955, Ref 57) test results on the analysis of Compn B loaded 90mm shell indicate that the quantity of wax found in the cast is closer to 1%, and that it is distributed relatively uniformly thruout the cast. These findings are in agreement with previous results reported in Ref 53. There appears to be no advantage from either the speed of uptake or ultimate wax content in incorporating the wax first with the RDX before combining with TNT, rather than adding it directly to the RDX/TNT melt. If the slurry contains water, the wax is taken in much more slowly

Work conducted by J. Rubin at PicArns and reported in Ref 18 indicates that there is no significant difference in sensitivity between the 60/40/1 RDX/TNT/wax mix (Compn B) and the 60/40 mix without the wax when the expls are tested in the powdered form in standard laboratory tests. These studies also indicate no difference in stability, physical or other expl characteristics or casting properties. Subsequent results of work also reported by Rubin (Ref 24), however, indicated that when the two compns are tested for sensitivity in the cast form, the unwaxed expl is more sensitive than the waxed compn. Tests conducted which show this difference in sensitivity are the large scale Bureau

of Mines Impact Apparatus (uses 200-kg wt impacting 20 gram samples), and rifle bullet impact. Also reported are tests involving 500-lb bombs, some loaded with Compn B and others loaded with 60/40 RDX/TNT (no wax), which are impacted against hard concrete surfaces from altitudes of 4000 ft. Bombs containing the Compn B passed the test but those containing the 60/40 RDX/TNT (unwaxed Compn B) did not. Further confirmation of the effectiveness of the small percentage of wax in Compn B is found in results of the SKID test. Results of such tests are reported in Refs 81 & 106

Refs 23, 61 & 92 report on the evaluation of a variety of commercial waxes for use in Compn B. A partial list of these materials found acceptable are:

90/10 Aristowax/Alox 600
 Be Square
 Victory wax
 90/10 Stanolind/Alox 600
 90/10 Standard Refined/Alox 600
 Amber 180/185
 ES-290-3
 IRM-800
 No 1670
 No 1671
 Cerese AAA
 Stanolind 170/175
 No 8810 (X-10525)
 X-9807
 X-10325
 X-10326
 Stearyl alcohol
 R-68097
 M-62652
 Sonneborn No 68835
 ES-409
 Warco 180 Brown
 Shell Wax 700 Code 8798
 Shell Wax 600 Code 8798
 ES-670
 IRM-170C

The work conducted by C. Jacobson et al (Ref 61) on SAE 10 engine oil (MIL-O-2104) along with the waxes for use in Compn B is significant. His results indicated that the oil produced a satisfactory Compn B which exhibited only a negligible amount of exudate. It is stated in the report, "Since there is no need now (1957) to use the SAE 10 engine oil it should not be

approved for use in Composition B. It would be well though to consider this oil if the supply of waxes ever becomes short. At that time it would be necessary to make a composition containing only 1% oil and to add it directly to the melted RDX/TNT rather than coating the oil on the RDX beforehand." With the current (1981) prolonged shortage of suitable waxes it may well be time to consider this alternate

In some of the initial work in the development of the Compn B formulation, the RDX was first coated with the wax and then incorporated into the molten TNT. The objective was to utilize the desensitizer where it would do the most good, surrounding the more sensitive expl. It was soon determined that the wax coating on the RDX melted when placed in the molten TNT and was preferentially replaced from the RDX surface with molten TNT. Ref 69 supplies the technical explanation for this

The following two approaches to rendering Compn B type expls more insensitive were investigated and reported in Ref 46; the first by coating the RDX crystals with inert materials such as waxes and/or polymeric compds of sufficiently high melting points to prevent their remelting in molten TNT or at ordinary steam temp, and the second by the addition of a wax directly to Compn B by means of a wax/TNT emulsion. Two compns were developed which have markedly less sensitivity than Compn B. Their formulations are given in Table 9

Table 9 (from Ref 46)

Material	RDX Coated	Wax Emulsion
RDX	55.2	57.0
TNT	40.0	38.0
Polyisobutylene	1.2	—
Wax (mp 102°C)	3.6	—
Wax Stanolind, Aristowax (mp 170/5°F)	—	4.8
Polyvinyl acetate/ resin adhesive	—	0.2

Of the two compns, the wax coated RDX is the preferred. It was concluded that both these compns are, on the basis of laboratory and small scale tests, less sensitive than Compn B to impact and rifle bullet tests, but not as insensitive as

TNT. It was recommended that further work on these approaches, and scaled up sensitivity tests on 500 and 1000 pound bombs be conducted

This type of work continued and is reported on in Ref 50. A modified Compn B was developed which had a cast density of 1.64g/cc, is equivalent to Compn B in the sand test, is slightly inferior to Compn B in the shell fragmentation test, but is comparable with TNT in impact and rifle bullet sensitivity. This compn is composed of 60/32/8 RDX/TNT/N-octadecyl phthalimide. It was recommended that this compn be evaluated in components where Compn B is normally used

Work on Compn B is continuing (1981). At present two approaches to improving the expl are being taken. One is basically a continuing effort to find suitable waxes in the quantities required. The two waxes, Industrial Raw Materials 170C and Petrolite Corporation ES-670, used in the recent past are definitely inferior to previously used waxes. Both waxes readily segregate (170C more than ES-670) from the molten compn and generally require much greater process controls for use (Ref 27). It was determined (Ref 99) in loading plant studies that higher percentage rejects were observed when using these two waxes. Defects were correlated to (among other factors) the initial temp of the shell bodies at the time of loading. The higher the temp the greater the probability of developing cast charge defects. Use of good microcrystalline waxes (Sunoco 8810) which met the requirements of Grade A material (MIL-W-20553) did not exhibit such temp sensitivity. The other waxes currently being investigated in large scale loading studies are H.B. Fuller Wax WW 0064 and Emery Wax 1251D

The second approach is thru the modification of the Compn B formulation and the elimination of cast charge defects, especially at the interface with the projectile base. Studies have centered primarily in the utilization of crystal control agents - polymeric materials, HNS, etc, the finish on the interior of the projectile, and on controlled loading cooling processes

Torpex/HBX (see Vol 7, H1 & H23-H35 and Vol 9, T324-T329)

Early in the 1940's the British introduced

another TNT based castable expl containing RDX and Al known as Torpex. A very complete history of the US evolution of this type expl is contained in Ref 31. Because of viscosity problems Torpex 2 was developed. Almost 3% more TNT was used, and since it was made starting with Compn B, the finished Torpex 2 contained approx 0.7% wax (either beeswax or Wax No 10). In use it was noted that the viscosity of Torpex 2, even with the additional quantity of TNT, was more viscous than Compn B. This increase in viscosity was attributed to the wax, resulting in the agglomeration of the Al particles

After a series of accidents in the US, mainly in loading plants and depots, a more insensitive Torpex containing a greater quantity of wax was developed. The British formulation (Ref 30) for the wax desensitizer for Torpex consisted of 84/14/2 paraffin/low density nitrocellulose (12.2% nitrogen)/lecithin. The US version of this material (Ref 32), known as Compn D-1, has the following formulation (see Vol 3, C488):

Material	% by Weight
Paraffin (mp 55°C)	84*
Nitrocellulose, lacquer grade, 1/2 second viscosity	14*
Soybean lecithin	2*
Moisture	2 max

* dry basis

Because there were objections to the use of low melting paraffin in ammo to be used in the Pacific Theater where relatively high ambient temps are encountered, work was directed in modifying the D-1 Compn to utilize a high melting wax to replace the paraffin. The expl mixt utilizing the modified D-1 Compn, designated as Compn D-2, was called HBX. The formulation of HBX is 38/17/40/5 TNT/Al/RDX/D-2 Compn. This expl is basically Torpex 2 with 5% Compn D-2. The requirements for the D-2 sensitizer are as follows:

- 1) It must desensitize Torpex as well as does the paraffin in the D-1 formula
- 2) It must not adversely affect the stability of Torpex
- 3) It must be available
- 4) It must be incorporated at the temp of molten TNT (about 80°C)

5) It must not separate from molten Torpex as a supernatant layer

6) It must not exude at 60°C

The greatest difficulty in the development of the D-2 Compn was in finding a suitable wax which would be readily dispersed in the molten TNT and still not exude from the solidified cast when subjected to 60° for prolonged periods. It was found that only one wax fulfilled all the conditions. This wax was designated as Stanolind 170-5. However, it was learned that a number of wax blends (referred to as "synthetic") could be used very satisfactorily. All of these were blends of tank-bottom waxes (microcrystalline), which are normally considered to have too high melting points (82–87°C), with lower melting waxes

Results of further work in finding suitable waxes for Compn D-2 used in HBX indicated that the use of 0.5% calcium chloride added to HBX reduced significantly the quantity of exudation which occurred during storage at 60–65°. It was suggested that this reduction in the exudate was a result of decreased gasing effected by the addition of the calcium chloride. It is postulated that the calcium chloride binds up any moisture present, preventing it from reacting with Al and developing gas. This reduces the gas pressure which is believed to be the driving force which pushes the partially molten wax from the cast charge. The expl compn with the 0.5% calcium chloride became standard and was designated as HBX-1

The degree of desensitization of HBX by wax seems to be practically independent of the wax used. This, however, does not mean all waxes are the same. There are waxes which are chemically incompatible with HBX. One of these, designated as Acrawax, caused large volumes of gas to be generated when heated in contact with the expl. Further, as mentioned above, some waxes (ie, hentriacontanone) caused excessive agglomeration of the Al. This agglomeration is believed to be due in part to fatty acids present as impurities. Use of the wax, hentriacontanone, after treatment with sodium carbonate completely eliminated the agglomeration problem

The two ingredients in the Compn D's other than the wax are Nitrocellulose and lecithin. These two materials are used to emulsify and disperse the wax in the molten TNT. While NC

did not cause a stability problem, it caused concern that it might. Programs were conducted to determine if suitable replacements could be found. Work conducted (Ref 37) indicated that a partially hydrolyzed polyvinyl acetate known commercially as Vinylseal MA 28-14 was a satisfactory replacement for NC and lecithin (carbon black was suggested but not thoroughly investigated). This material meets the specification requirements previously established as an emulsifier of wax in molten TNT. These requirements are outlined below:

1) Thoroughly emulsifies waxes in molten TNT (wax does not separate from molten HBX over a period of an hour at 100°C)

2) Wax does not separate from the HBX ("sweat") when the material is cast

3) Emulsifier does not agglomerate the Al

4) Stability of the expl is better than that of the HBX made with NC and lecithin; the sensitivity is unchanged

5) Viscosity of molten expl is not unduly increased

It is interesting to note that HBX made with NC but no lecithin, or with lecithin but no NC does not produce a satisfactory expl compn. With NC alone most of the wax separates and the compn will not pass a 100°C storage test. With lecithin and no NC no wax can be incorporated

As a result of the extension of work on Compn B covered in Refs 46 & 50 to the HBX type expls, three compns are indicated to be less sensitive to mechanical shock than the 40/42/18/5 TNT/RDX/Al/Wax HBX-type expl. The formulations of these three expls are:

Material	A124-1	A124-3	A131-1
RDX	30	40	50
TNT	32	32	32
Al	30	20	10
N-octadecylphthalimide	8	8	8

With the successful incorporation of about 5% wax in the HBX expl, trials were conducted in attempting to similarly desensitize other cast expl materials (TNT, Compn B, Tritonal) by increasing the wax content (Ref 35). It was found that as much as 20% wax (Wax No 10) could be emulsified in TNT by use of a NC emulsifier. The mix showed negligible separation at 100° in several hours. However, because of the questionable stability of the NC, the use of

this emulsifier was abandoned for this application

Increased quantities of wax were tried in 60/40 Cyclotol, and rifle bullet tests in 1" pipe nipples were conducted to determine their sensitivity. These compns were prepd by mixing TNT, paraffin and 0.2% lecithin in a lab homogenizer and then adding the RDX. The emulsions produced were not particularly stable. Results of the bullet tests are shown in Table 10

Table 10 (from Ref 25)

Explosive	Cal 0.30 Ball M2		Cal 0.50 Ball M2	
	# Trials	% Inert	# Trials	% Inert
Cyclotol 60/40	206	54	19	53
Composition B	392	70	101	50
Cyclotol 60/40 + 2% wax	20	75	—	—
Cyclotol 60/40 + 3.8% wax	40	93	30	77

Compn D-2 was tried in TNT and Tritonal to the extent of 5% (added) and compared in lab sensitivity tests with 52/48 Picratol and RIPE (85/15 RDX/Gulf Crown E Oil). In bullet tests the order of sensitivity ranging from most insensitive down is as follows:

RIPE
TNT/D-2 95/5
Picratol 52/48
Tritonal/D-2 95/5
TNT
Composition B
Pentolite 50/50

In impact tests the order was the same except that Tritonal/D-2 95/5 and Picratol 52/48 were reversed

Addnl work was conducted on the use of surfactants for reducing the interfacial tension between TNT and paraffin waxes. Refs 98 & 100 report results of tests using the n-octadecyl, n-hexadecyl, n-dodecyl and n-hexyl esters of 2,4,6-trinitrobenzoic acid to permit stable homogeneous blends of paraffin waxes in molten TNT. It is reported that all these materials act as surfactants and that the interfacial activity increases as a linear function of the alkyl chain length of the ester. N-octadecyl 2,4,6-trinitrobenzoic acid also acts as a surfactant for the beeswax/TNT system. It was concluded, however, that the degree of reduction in the interfacial tension of

the paraffin/TNT system sought was insufficient for the practical use of these surfactants

Another problem associated with waxes/surfactants/TNT involved the frothing of TNT when melted for loading shell. The use of the frothing TNT resulted in cast charges with excessive porosity and pits. The frothing was traced to small quantities of grease or paraffin wax contamination of the TNT. This condition was eliminated by adding 0.01% of the surface active agent Duponol C or Span 85 to the melt (Ref 25)

Cast Compositions Using Wax as the Vehicle

Because of the high dilution by a non-reactive material required to achieve a reasonable fluid slurry, the use of wax as the vehicle in desensitized castable expls is not widespread. Results of initial work (Ref 35) indicated that over 20% wax is required to achieve a pourable slurry using ordinary production grade RDX. The quantity of wax required to attain a castable mixt with better control on the particle size distribution of the RDX is lowered to about 16%. Such an expl passed the most violent bullet test available (approx 1942). It is reported that the British managed to prepare a pourable RDX/Al/wax mixt using only 12% wax. Lecithin was used as a surfactant in this mix. Results of work in the US on a similar mix, but using monomeric materials instead of wax, indicated that the fluidity of the slurry is highly dependent on both the particle size distribution and the shape of the particles. Trimodal distribution of spheres was thought to be ideal for solids

At the present time (1981) there is one expl that uses wax as the vehicle. This compn, covered by Specification MIL-C-60051, consists of 86/14 RDX/wax (Ref 89). It is loaded by a puddling technique in combination with pellets of Compn A-3, and is used as the main charge of a 165mm high capacity projectile

Preparation of Press and Cast Loaded Explosives

There is no question that the method used and the degree of coating of the wax over the surface of either the RDX or HMX crystals is of prime importance in desensitizing the basic materials to mechanical stimuli. Likewise probably the most important property of a desensitizing wax for use in TNT-based expls is its

ability to be uniformly dispersed thruout the liq and solid phases of TNT (Ref 69). Techniques used in the prepn of these mixes is, therefore, of prime importance. The following prepn methods have been used:

Pressed Explosives

The initial 91/9 RDX/beeswax developed by the British was produced by milling a water slurry of boiled RDX in a disc mill set at 0.020 to 0.010 inch. All the RDX must pass 30 mesh BSS and not more than 20% must pass 120 mesh BSS. The slurry is heated to 80–90° with stirring, and the 9% beeswax (previously filtered thru 60 mesh stainless steel gauze) is added. The mix is continued to be stirred for 20 minutes. It is then filtered and, while retaining about 10–15% water, it is passed thru bronze differential rollers (speed ratio 80:20) set 0.02 inch apart, 5 to 7 times. It is dried at 95–100° in a Pfeleiderer type incorporator (Refs 9 & 11). The 91/9 RDX/beeswax expl produced in this manner is known as Composition A

Compn A-3 is produced in a similar manner but without the final rolling operation. A water slurry of RDX heated to about 90° has the molten wax slowly added while the slurry is rapidly stirred. The RDX/wax agglomerates are filtered and dried in a hot air bed (Ref 82). Detailed studies were conducted on the effects of varying the process on the coating of the crystals. Factors such as the use of surfactants, wax viscosity, solvent coating, rolling, drying and graining are reported in Ref 33. The requirement to achieve a good coating on RDX is illustrated by the impact sensitivity values presented for RDX, RDX/wax without the use of Alox 600, and RDX/wax with 10% Alox 600 in the wax:

Sample	Impact sensitivity,
	50% point, cm Type 12 tools
RDX	15
Comp A-3 no Alox 600	31
Comp A-3 w/Alox 600	72

The most recent method of coating RDX is with the emulsion encapsulation technique (Refs 103, 104, 109 & 111). The process involves essentially the following steps:

1) Suspend RDX in water slurry by stirring. Heat to about 190°F

2) Slowly add weighed quantity of emulsified wax

3) Add required quantity of emulsion breaking agent – barium chloride, acetic acid, ammonium stearate, & magnesium sulfate

4) Simmer for 30 minutes maintaining temp

5) Cool to 50°C

6) Discharge thru Sweco with 12-mesh screen, to filter pan

7) Dry 16 hours at 60°C

The method described in Ref 109 for the emulsion encapsulation process is about the same as that described above. Sulfuric acid is used to break the polyethylene wax emulsion. In addition, 0.05% methyl p-hydroxybenzoate is used in the final wash to prevent mold growth

Cast TNT Type Explosives

The 60/40 RDX/TNT type expls containing about 1% wax (Compn B) are prepd by initially melting the required weight of TNT in an appropriate steam heated (15 psi max steam pressure) mixing kettle. Water wet RDX is added to the molten TNT with stirring. Water floating on top of the slurry is decanted, and mixing is continued until the temp reaches about 105°. At this point the proper quantity of molten wax is added and mixing continues until a homogeneous compn results. The mix is then metered out onto an endless stainless steel belt, which is water-cooled from the underside. The expl solidifies by the time it reaches the end of the belt where the "chip" falls into a collection box

Some early exptl mixes of RDX/TNT/wax were prepd using a variety of processing techniques (Ref 15). One involved precoating the RDX with wax before it was added to the melted TNT. It was readily determined that use of wax in this role, which melted below the temps used in processing, were preferentially displaced from the RDX surface by the liq TNT. However, if the wax used is a high melting one, the wax will remain coated on the RDX in molten TNT (Ref 46). Such compns show a decrease in sensitivity over the conventional Compn B. To date (1981) this method of preparing Compn B has not been used in any other than laboratory scale testing

Shock Attenuation

Waxes have been investigated and utilized in the role of shock attenuators in both testing of expl materials, in gap tests (Ref NAVORD

2385), and in practical applications as nose pads. In Nov 1941 (Ref 35) attempts were made to develop a waxy lining material for AP shell and bombs. It was expected that such linings would aid penetration of armor targets without premature activation of the expl filler. One coating material consisting of 75/25 Plasticizer E-60 (Hooker Electro Chem Co)/Acrawax-C (Glyco Products Co) was developed.

In tests (Ref 30) to determine the effect of liners and coating on the sensitivity of 50/50 Pentolite charges contained in bombs it was concluded that "very little effect was obtained with a wax coating on the inner surface of the bomb, but an asphalt dip reduced the detonations considerably." The tests conducted were rather limited in the variety of waxes tested. Subsequent tests in 100-lb bombs were somewhat inconsistent with the initial finding. Seven hundred-fifty lb general purpose bombs loaded in the 1970's did use both a nose pad and liner of a bituminous material.

As mentioned previously (Ref 22) the use of Al-wax nose pads, 80/20 and 90/10, was investigated for use in AP shot in rifle bullet impact bombs. From these test results the use of the nose pad appears to produce better results (output) and would be the more practical system to load. In addition it is felt that such a system would reduce or prevent premature activation of HE loaded projectiles when striking armor plate.

Binding/Lubricating

Closely associated with the ability of waxes to desensitize expls is their ability to lubricate. The lubricating characteristics of waxes are believed to be an important factor in reducing the sensitivity of expls, especially when they are subjected to mechanical stimuli at relatively slow rates. Expl particles coated with wax, particularly in the loose (or low density) condition, when impacted or subjected to frictional forces have a greater tendency to deform and flow away from the point(s) of stress. This mechanical action distributes the input energy over a much greater area, thus reducing the probability of developing sufficient energy at any specific location (hot spot) required for activation. Ref 81 presents results of tests on cast 60/40 RDX/TNT with and

without 1% wax to an oblique impact. Significant decrease in sensitivity of the waxed expl is indicated greater than in other sensitivity tests. This difference is attributed (by the writer) to the lubricity provided the charge through the incorporation of the wax.

It is well known that the drag and interparticle friction of a powder affect its flow characteristics and packing density. It has also been recognized that the characteristics lubricating property of waxy materials when they are mixed with expl render the resulting comp much less susceptible to activation in processing operations. The wax coating on the expl crystals overcome the cohesion between particles, and improves both free flow and flow under consolidation pressure during die filling and compaction phases, respectively. Most non-TNT type expl contain waxy additives and are almost always used in a consolidated form (pressed in a cavity, ie, a shell, or pressed in pellet form for subsequent assembly). Up to about 2% of stearic acid or a metal soap (ie, calcium resinate) with or without graphite is added to materials such as Teteryl, RDX or HMX to facilitate compaction of the loose expl into pellets (or tablets). This enables production of strong, high density pellets using minimal consolidation pressures and dwell times. In addition, waxy additives also reduce die wall friction during both the compaction and pellet ejection phases. This of course results in a reduction in tool wear.

During the initial work in investigating various waxes to replace the beeswax in the 91/9 RDX/beeswax - Composition A (Ref 11), concern was expressed relative to the range of hardness of the candidate waxes. It was felt that if the wax coating on the RDX crystal is too hard, it will probably also be brittle and crack away from the RDX when subjected to sudden stress, and even if it does not, heat will be developed in the wax. If the wax is too soft, it will be too easily forced by pressure out from between the crystals of the expl, as well as giving excessive exudation. It was considered that a certain amount of tackiness is a necessary characteristic of waxes used in the 91/9 RDX/wax composition. Such wax will give a more dense charge on pressing than one which tends to be springy or brittle. Also a degree of tackiness is also necessary for proper milling qualities (a method used to product Composition A)

Table 11
Properties of Some Pelleting Materials

(G = Good Effect, A = Average Effect, P = Poor Effect)

Material *	Property									Remarks
	Flow properties of composition	Non-Segregation of ingredients of compn	Pelleting Power	Retardation of Rate of Burning	Sparkiness of Flame	Effect on Efficiency of Composition	Ignitability of Composition	Sensitiveness of Composition	Waterproofing Power of Materials	
Paraffin Wax	A	A	G	A	G	A	A	A	P	Applied molten to magnesium powder
Beeswax	P	G	G	G	G	G	P	G	G	Applied molten to magnesium powder
Carnauba Wax	G	A	A	G	A	A	A	G	A	Applied molten to magnesium powder
Candelilla Wax	A	G	G	A	G	A	P	G	G	Applied molten to magnesium powder
Chinese Wax	G	A	A	A	A	A	A	G	A	Applied molten to magnesium powder
Boiled Linseed Oil	G	P	P	A	G	A	P	A	A	
Lithographic Oil	P	G	A	G	G	G	P	G	G	
Tung Oil	P	G	A	A	A	A	P	A	A	
Castor Oil	P	A	A	G	A	A	P	A	A	
Shellac Resin	G	P	A	P	P	P	G	P	A	Applied as spirit varnish to magnesium powder
Acaroid Resin	G	P	P	P	A	P	G	P	G	Applied as spirit varnish to magnesium powder
Bakelite Resin	G	P	A	P	P	A	G	P	G	Applied as spirit varnish to magnesium powder
Polyester Resin	G	A	G	P	A	A	A	A	G	Applied as the liquid monomer to magnesium powder and cured after incorporation of the other ingredients
Chlorinated Rubber	A	A	G	P	G	G	G	P	G	Gelled by the addition of a suitable solvent to the composition
Thiokol Rubber	P	G	G	G	G	A	P	G	G	Applied as the liquid monomer to magnesium powder and cured after incorporation of the other ingredients
Silicone Rubber	A	G	G	A	G	A	P	A	A	Applied as the liquid monomer to magnesium powder and cured after incorporation of the other ingredients

* Comparisons are for equal proportions

The British, in developing techniques to form strong pellets of their pyrot compns by consolidation, investigated a number of additives which act as binder/lubricants (Ref 73). Four groups of materials were investigated: waxes, oils, resins and rubbers. The principle functions of these materials in pelletting pyrot material is:

- 1) To increase the cohesion between the particles of the ingredients when consolidated under pressure
- 2) To protect the particles of Mg powder from

corrosion by the moisture and the electrolytes present in the mixt

- 3) To modify the rate of burning
- 4) To enhance the luminosity or color of the flame
- 5) To modify the sensitiveness of the mixt to ignition by friction or blows
- 6) To enable rigid pellets to be obtained with lower pressing loads

Table 11 (taken from Ref 82) compares the relative effectiveness of various waxes tried with

each other and with the other classes of materials. Both beeswax and paraffin waxes are used in British pyrot formulations. It is indicated that beeswax is one of the outstanding materials in this table, however, it is not often used in pyrots

In Ref 109, where pressing studies were conducted with RDX/polyethylene wax compns, it was concluded that the "ease of pressing of the compns depended markedly on the wax content." Below about 9% wax, the density of the compact (relative to the theoretical maximum or voidless density) achieved by pressing at a load of 4.9kN (1034 lbs) increased with wax content, but above this wax content the density attained under this load was essentially constant (see Fig.4)

In much the same manner Candelilla was incorporated into the compn of the propht used

in the Rocket Assisted Projectile for the 155mm M549 round, as well as in N5 propht (see Vol 8, P407, table 2). Here the wax is added to aid in the extrusion of the rocket grain (Refs 68 & 117)

In Ref 82 it is stated that 11 explns of Composition A-3 had occurred during press loading operations at various loading depots. Ten of the 11 explns had occurred while using A-3 produced by the Wabash River Ordnance Plant and only one while using A-3 produced by the Holston Plant. Despite this, the loading depots preferred to use the Wabash material because they had loaded many more projectiles with this material, and because of their concern when the greater quantity of uncoated RDX crystals in the Holston A-3 material was noted as compared to the Wabash A-3 lot

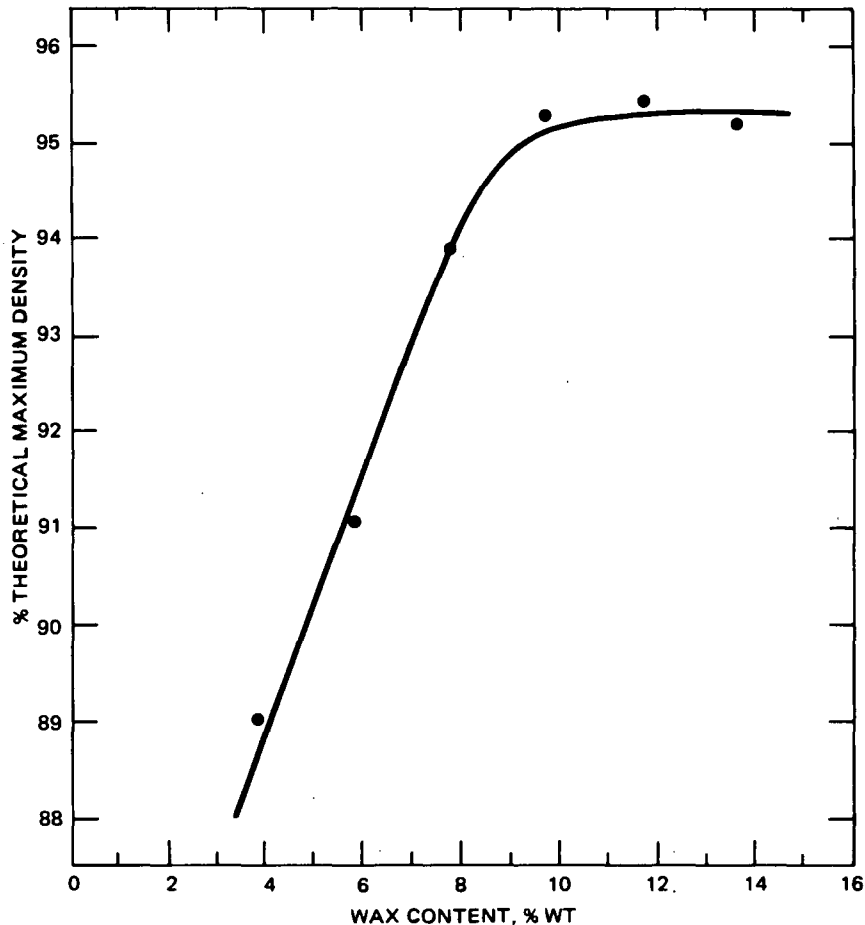

Fig 4 (from Ref 109)

Density of RDX/Polyethylene Wax, pressed in a half-inch mould with a pressing load of 4.90 kN and a dwell-time of 2 minutes, as a function of wax content

In recent years waxes have found use in the role of a lubricant in reducing gun barrel wear (see Vol 8, P419). This wear results from both the hot gases generated by the burning propellant and the mechanical abrasion of the projectile as it is propelled down the gun tube. Wear-reducing liners consisting of titanium dioxide and wax have been used in conjunction with propelling charges since about 1962 (Ref 85). The liner is wrapped around the propellant charge. This type liner was invented in Sweden to replace the foamed polyurethane used in Canada (Ref 112) as a wear reducing material

Ref 113 deals with a problem of cloth residue associated with the use of the wear reducing liner in hot gun tubes after functioning propellant charges which were previously conditioned at 63°. The wear-reducing additive liner for the M203 propelling charge contains 53.5/46.0/0.5 Wax/TiO₂/dacron fiber. The wax used was a paraffin wax (Shell 300) having a drop melting point of 71°. Thru extensive testing (Ref 114) the residue problem was traced to the use of the low melting wax. It was proposed that there would be less residue if the wax used in this application were brittle over the broadest temperature range. By using a higher melting wax, Indramic 170C, mp 82°, and some other minor changes, the residue problem appeared solved. The proposed use of a higher melting wax is in agreement with results of independent work reported in Ref 112. However, further tests using this wax indicated that the frequency of the presence of residue was still unacceptably high. Two synthetic waxes, Polywax 500 and 655 were investigated (Ref 115) in this application with best results being obtained. Polywax 655 is recommended as a replacement for the Indramic 170C wax in the M203 charge. Some of the characteristics of the waxes investigated in this program are presented in Table 12

A somewhat unique role of waxes as a lubricant is proposed in its utilization in cast Composition B. It was noted by the British in their initial work with beeswax (Ref 14) that the addition of 1% wax, although it did not apparently decrease the sensitivity of the resulting expl, did seem to improve the handling characteristics of the molten material. An extension to this is noted in work at PicArson (Ref 92) where the resulting quality of the cast of 60/40 RDX/TNT with and without 1% wax indicated that use of certain waxes (ie, Sunoco 8810) consistently produced higher quality charges than when no wax is used. Further, the other waxes (ie, Indramic 170C and Pentrolite ES 670) which when used produced inferior casts as compared to those of 60/40 RDX/TNT alone. It is considered from this that some waxes in Composition B could act as "casting aids"

Although no specific tests have been conducted it is felt that these "casting aids" influence, through their lubricating characteristics, the viscosity or flow characteristics of TNT while in its plastic phase (Ref 79). This conjecture is based on study of typical thermal cooling curves occurring during solidification of cast Composition B charges in 105MM M1 shell, and the specific location and type defects (cavity) formed. It is possible that the wax could act as a surfactant and reduce the resistance of the hot plastic TNT to flow through the narrow channel in the riser during the cooling (and solidification) of the TNT in cast loading operations

Very little other work has been conducted in investigating optimum pressing characteristics of waxed expl comps. Most is limited to empirically determining the characteristics of materials and their resulting compacted charges, such as spring-back, growth, and strength. However, considerable amount of investigative work has been conducted involving the compaction of powders in the

Table 12 (from Ref 115)

Wax	Initial mp		Liquid Point		Heat of Fusion cal/gm	Pent at 43°C 0.1mm	Drop mp	
	°C	°F	°C	°F			°C	°F
Shell 300	12	54	76	169	49.8	30	71	160
Indramic 170C	3	37	91	196	42.5	45	80	176
Polywax 500	12	54	97	207	55.8	21	88	191
Polywax 655	12	54	109	229	58.9	7	102	215

pharmaceutical, powdered metallurgical and ceramic fields. Much of the information on these materials, including the use of waxy materials as lubricants, can be applied to the field of expl compaction

Sealant

Because of their ability to form relatively thin continuous films in conjunction with their hydrophobic nature, waxes are used extensively as a protective coating, primarily as water/moisture barriers. Most common example of this is in the use of household "wax paper". This material is usually used to wrap sandwiches so that the bread and filling do not dry out. Here it is desired to keep the moisture in. Waxes are also applied in the emulified form to the exterior painted surface of our automobiles. They are utilized to prevent both water/moisture and air from contacting the painted surface. Such barriers prevent oxidation and prolong the life of the painted surface

Another example, not seen very often these days, is the application of paraffin wax, in molten form, to seal off air from freshly prepared jars of home made jams, jellys, etc. The resulting wax seal is very effective in this application because of its good adhesion to the glass portion at the top opening of the jar

The use of wax as a sealant in connection with expls is recorded in Ref 2. Cartridges of TNT (which in Germany replaced Picric Acid - Sprengmunition 88) for demolition purposes (Pioneer's Cartridges) were protected against breakage and moisture with paraffin and paraffined paper. Ref 3, 4 & 5 contain examples of use of wax as a waterproofing material and some of the diffi-

culties encountered in their application. The specific waxes used included beeswax, lanolin and paraffin

The inert sealing compds covered by Specification MIL-S-3105C saw extensive use during the South East Asian (SEA) conflict. The compds covered by this specification, listed in Table 13, are used for sealing/padding nose and tail portions of the expl cavity of bombs

Type I sealant is suitable for use when the expl charge is TNT, Tritonal, Picratol and Minol-2. Type II is to be used with TNT, H-6, Tritonal, Composition B, Picratol and Minol-2. The sealing compd is melted and poured into the specific cavity where desired. The sealer in the tail portion of the bomb is poured in the cavity as soon as the freshly poured molten expl charge has "crusted over". The base plate, which closes the assembly, is screwed into place while the sealing compn is still molten. Some bomb base plates are equipped with anti-withdrawal pins which extend down into the wax pad. Disassembly of the base plate after the compn solidifies is made difficult because of these pins

Ref 56 describes a 1500 lb blast warhead which utilizes the Type II compd to prevent the exudation of the high expl during high temp storage. It is stated that "should high temperature storage cause a crystal growth which increases the volume of the explosive, inert material will be exuded rather than high explosive". This is exactly what happened to the 750 lb M117 bombs loaded with Tritonal and with Minol-2 during the SEA conflict. So much growth occurred that the quantities of inert compd extruded completely filled the fuze wells of these bombs. This material of course had to be removed before the bomb

Table 13 (from MIL-S-3105C)
Sealant Compositions

Composition, % by weight	Type		
	I	II	IIA
Ingredients			
Glyceryl ester of rosin	39.25± 1.00	—	—
Glyceryl ester of disproportioned rosin	—	45.0± 1.0	—
Hydrated aluminum silicate	39.75± 1.00	40.0± 1.0	41.25± 0.30
Hydrocarbon wax	12.25± 1.00	10.0± 0.5	20.00± 0.50
Petrolatum	8.75± 0.50	5.0± 0.2	16.50± 0.50
Natural hydrocarbon resin of fossil origin	—	—	22.25± 0.30

fuzes could be assembled. A second reason given for the use of the sealer in Ref 56 is that it "also prevents possible detonation due to 'pinching' of the explosive between the body and the cover plate or adapter boosters"

The paper used to form the tubes that contain the constituents of the various types of Dynamites are heavily impregnated with paraffin wax. After the tubes are filled and crimped, they are dipped into molten paraffin wax. This technique is used to seal the Dynamite sticks against moisture (Ref 20). Similarly a heavy coating of paraffin wax is used to protect commercial highway emergency flares from water and moisture

Many of the ingredients used in pyrot compns, fuels/oxidizers, are sensitive to moisture. Most oxidizers are hygroscopic, ie NaNO_3 , NH_4NO_3 , etc. Some fuels oxidize readily when exposed to moisture, ie, Mg, Fe, Al, etc. These materials have been protected with coatings of paraffin wax (Refs 20 & 41). Both stearic acid and stearin (mixt of stearic and palmitic acids) have been used to coat and protect Al from moisture

Ref 94 covers studies involving use of Mobilwax 2300 microcrystalline wax, paraffin wax, ethylene vinyl acetate copolymer (Elvax 40, 250 and 350), DOW Corning Silicone C-2-0563 and VAAR (vinyl alcohol acetate resin) to protect reactive pyrot materials from water/moisture. Coatings are accomplished by solvent solution and fluidized bed techniques. The specific materials coated and tested are Mg, Al, Na nitrate and Blk Pdr. Test results indicated Elvax 350 to be the preferred material to protect Blk Pdr, while a mixt of 60/40 microcrystalline wax/paraffin wax with 0.5% Elvax 350, added, appeared most effective in protecting pressed Mg/Na nitrate compns. These investigations are not yet completed

Ref 93 covers work in the development of a satisfactory coating to be used on the M205 non-metallic cartridge case. This coating is to provide protection of the case against hydraulic fluids, water vapor and liq water, and shall not leave residue in the gun when used. Coating materials investigated include microcrystalline, amorphous or low molecular weight polyolefin waxes and/or other appropriate compounding additives. It was found that the coating techniques used has a very pronounced effect on the degree of success achieved. It was recommended

that a Polyvinyl alcohol/Saran system be optimized and investigated for use with a solventless barrier coating technique

During WWII, Japanese artillery (Ref 36) contained a maincharge (TNT, Trinitroanisole, Picric Acid) which was cast in individual blocks and sealed in waxed paper containers. These containers, in turn, were encased in a heavy cotton flannel bag and sealed in the projectile with paraffin. It is presumed that this assembly was used to facilitate loading, to retain any exudation from the expl charge, and to protect the expl charge by providing an inert material to fill any voids in the interior of the projectile

Fuels

Waxes have long been utilized as fuels (ie, candles), and were probable part of some Alchemist's secret formula for Greek Fire, where the wax's high heat of combustion (11kcal/gm), sticky characteristics, and easy flammability were used to advantage. Paraffin waxes, and to a lesser degree, stearin, stearic acid, beeswax and carnauba wax, were used extensively in the match industry (Refs 8 & 76). The waxes were used principally as the fuel in the stick portion of the match, and as a replacement for sulphur for a flame transmission agent between the ignition compn and the wood or paper splint. The wax also served a secondary role as a water resistant coating on the splint. In 1832 the "vesta" was patented. This device consisted of a wax stem reinforced with cotton threads and tipped with a phosphorous compn. These "candle-matches", which were ignited by friction, produced about two minutes of light

Waxes cannot always be considered as desensitizing or phlegmatizing agents. The wax coating on fertilizer grade amm nitrate (FGAN), for example, added as an anticaking agent, unwittingly sensitized FGAN (produced a fuel/oxidizer expl compn) which contributed to disastrous explns of shiploads of this material in Texas City, Brest (France) and in the Black Sea (Refs 45, 62 & 107)

Ref 77 lists paraffin waxes as fuels in a group, along with sulphur, red phosphorous, Zr, Ti, Th, Ta and fuel oil, which have ignition temps in the range of 200 to 300°. The other two groups in this ref consist of materials (fuels) having ignition temps of 300 to 500° and up, respectively. Waxes were and continue to be used in fuel/

oxidizer compns for expls, a variety of pyrot compds and in exptl proplnts

Some fuel/oxidizer expl compns, known as Cheddites (Refs 20, 70 & 79, also see Vol 1, A140 under "Almatrites" and Vol 2, C155 under "Cheddites or Streetites"), contain paraffin wax as their principle fuel. The wax is used in conjunction with solid oxidizers, Na, K and amm chlorates and amm perchlorate. K perchlorate was not normally used because of its relatively high cost (Ref 79, p 279). Examples of specific compns of these expls are contained in Table 14. While such expls were used in military applications by the French and Germans during WWI in artillery ammo, mines and trench mortar bombs, use (if at all) at present is confined to very limited commercial blasting operations in Europe. This type expl did not see general use in this country in either military or commercial practice. The more conventional organic expls were used in military applications with the NG dynamites — later replaced by the ammonium nitrate/fuel oil (ANFO) or water slurry blasting agents — preferred for commercial blasting operations

Table 14 (from Refs 20, 70 & 79)

Ingredient	Composition, % by weight					
KClO ₃	90	—	—	—	—	—
NaClO ₃	—	90	90.00	—	—	—
NH ₄ ClO ₃	—	—	—	89.00	—	—
NH ₄ ClO ₄	—	—	—	—	90	61.5
NaNO ₃	—	—	—	—	—	30.0
Paraffin wax	7	7	9.25	2.97	10	8.5
Rosin	—	—	.25	7.15	—	—
Petrolatum	3	3	.50	.88	—	—

The use of waxes as fuels in pyrot compns have been investigated to determine their effect in augmenting the burning rates and desired output. Ref 17 covers one investigation in an attempt to increase the visibility, by increasing the duration of flash of a burst of 3 Inch HE AA shell, for both day and night firings. It involved the investigation of shell containing cartons of powdered Al with about 2% wax. Results of tests indicated that waxes had an unfavorable effect

Examples of pyrot compns containing waxes

Table 14a
Pyrotechnic Mixes Containing Waxes

Flare Ingredient	%
Ba(NO ₃) ₂	56
PVC	21
Mg	16
Montan Wax	7
Smoke Ingredient	%
KClO ₃	40
NH ₄ Cl	45
Montan Wax	12
Kieselguhr	3
Incendiary Ingredient	Parts
KNO ₃	47.7
Al	21.7
S	19.9
Sb ₂ S ₃	6.1
Wax	2.8
Illuminant Ingredient	%
Ba(NO ₃) ₂	35.6
KNO ₃	10.4
Mg	38.0
Wax	13.9
C	0.8
S	1.3
First Fire Mix Ingredient	%
KNO ₃	63.2
Fe ₂ O ₃	3.8
Al ₂ O ₃	1.1
S	8.2
Wax	5.5
Glass	6.1
C	12.1

utilized at least partially as a fuel (serves several purposes — sealant, lubricant, binder) are cited in Table 14a

Utilization of waxes as fuels in composite proplnts is not widespread. Waxes do not lend themselves to producing good mechanical proper-

ties in such compns. There is presently no standard proplnt of this type that utilizes wax. However, because of the convenience of their working properties, waxes have found use in exptl composite proplnts. For example, Ref 83 covers investigative work involving the determination of the expl characteristics of a simple composite proplnt model consisting only of amm perchlorate and wax. A 90/10 mixt exhibits a burning rate of about 0.3 inch/second at 1000 psi and a specific impulse, in a small motor firing at 400 psi, of 230 seconds. The calcd impulse at 1000 psi is 252 seconds. Both paraffin and carnauba waxes are involved in this study

Inert Simulants

Compds containing waxy materials have been used in the role of simulating, principally density, in expl systems. Ammo containing the inert load are used for training purposes and engineering tests. In the early 1930's inert fillers used were lead oxide/paraffin, barium carbonate/paraffin and barium carbonate/paraffin/lead oxide. The specific desired density was obtained by varying the proportions of the constituents

An early (1936) Pic Arsn Technical Report (Ref 6) states that a sealing wax of the type used for sealing dry batteries (listed in the Mitchell-Rand Manufacturing Company's Catalogue No 537 as M-R No 50 seal), was used in the assembly of the Weszycki Practice Hand Grenade to simulate the weight of the main expl charge. This wax had a melting point of 200°F, a pouring temp between 250° and 300°F, and a specific gravity on solidification of 1.58. It was used instead of the usual barium sulphate-paraffin-talc mix to preclude the tendency of the paraffin in the mix to flow, when exposed to hot weather, into the fuze mechanism

Other inert simulants containing waxy materials for TNT and TNT-based compns were developed. Specific formulations for these are listed below:

Mix A (Ref 10 & 37)

Ingredient	%
Plaster of Paris	60
Stearic acid	40

Mix B (Ref 37)

Ingredient	%
Paraffin wax	30
Iron oxide	34
Plaster of Paris	33
Carnauba wax	3

Mix C (Ref 37)

Ingredient	%
Polychloronaphthalene (PCN)	90
Celite	10

Comments on these mixes:

Mix A – Mix easily melted with 5 pounds of steam. Considerable exudation produced on simulated tropical storage

Mix B – Apparent excessive shrinkage results in loose casts

Mix C – Mix is toxic

Work covered by Ref 40 delved further into developing inert castable simulants using waxes to cover specifically the ranges of densities typical of the various castable expls. The expls, with the densities to be simulated are listed below:

Explosive	Avg. Cast Density, g/cc
50/50 or 60/40 Amatol	1.59 - 1.61
75/25 Tetrytol	1.60
Trimonite	1.60
52/48 or 55/45 Picratol	1.61 - 1.64
50/50 - 60/40 Ednatol	1.62
75/25 - 40/60 Pentolite	1.57 - 1.65
PTX-1	1.64
PTX-2	1.70
Composition B	1.67 - 1.68
HBX	1.70
Picric acid	1.71
80/20 Tritonal (waxed)	1.71
Torpex II (unwaxed)	1.76

Three types of formulations were recommended for simulating the densities of castable expls. These are:

Density range, g/cc	Mix Ingredient
1.30 - 1.55	Refined PCN ¹ WARCOT Wax ² MEKOB Wax ²
1.55 - 1.70	Refined PCN ¹ Aluminum, Grade B
1.62 - 1.78	AROSIN-A Wax ³ Aluminum, Grade B

Notes: 1 - Polychloronaphthalene

2 - Hydrocarbon wax

3 - Chlorinated diphenyl benzene, 60% chlorine

Table 15

Composition, % by weight

Crude PCN	Diatomaceous Earth	Hydrocarbon Wax	Iron Oxide	Density g/cc	Simulant For
69	8	23	—	1.40	Pressed TNT
90	10	—	—	1.58	Cast TNT
81	9	—	10	1.68	Cast Comp B

Ref 58 continues investigation of PCN and other waxes for use in simulating the densities of both cast and pressed expl materials. Mixtures of PCN and diatomaceous earth, with and without a hydrocarbon wax simulate expl densities between 1.20 and 1.85 g/cc. Specific compns are shown in Table 15. It was recommended that further work be conducted to develop a completely nontoxic inert filler. The PCN used is a mixt of 40/40/20 pentachloronaphthalene/trichloronaphthalene/higher chloronaphthalenes. The toxic limits reported (1955) are 0.5, 5 and 0.5 parts per million, respectively.

The Explosives Components Committee of the Joint Army-Navy-Air Force Fuze Committee published a listing (Ref 65) of the physical properties of expl materials together with the physical properties of some inert materials that might be used as simulants. Included is not only the density but a variety of other physical characteristics not previously considered before. Inert simulants containing waxy materials covered in this reference are shown in Table 16

Waxy materials are generally not used to simulate finished proplnt materials. Polymeric materials most nearly duplicate their physical properties. However, in one case (Ref 68, wax with and without sawdust, or similar carbonaceous material and cellulose acetate compns, respectively, are employed for loading (and cleaning) machinery used to produce proplnts. The inert materials do not necessarily duplicate operating mechanical loads or the dimensional charges occurring in proplnts during manufacture

Since there is no complete inert dummy simulants available to study manufacturing problems of NC type proplnts, semilive simulants have been developed and used. If ignited these materials burn slowly and incompletely. The formulation of the N-5 proplnt with that of its semilive simulant are compared in Table 17

Table 16

Designation	Composition
Inert Load No 2	57/15/28 Rochelle salt/ stearic acid/BaSO ₄
British Inert	32/2/31/35 Paraffin/Lecithin/ Kaolin/BaSO ₄
Paraffin	Paraffin, mp 61°C
Halowax 1012	Chloronaphthalene wax
Halowax 1013	Chloronaphthalene wax
Inert Simulants (1.59–1.84g/cc)	33–36% Glyceride ¹ , 0–60% DBG ² , 0–60% Fe ₂ O ₃ , 2–5% wood rosin or Sun wax 8835
Cast TNT Simulant	59/31/10 triphenyl phosphate/ Barite/stearic acid 90/10 PCN/DAE ³ 45/45/10 Parin/Santom/DAE ³ 80/20 Arosin-A/Al 80–100/20–0 PCN/Al 80–100/20–0 Arosin-A/Al 70–100/20–0/10 PCN/Al/DAE ³

Notes: 1—glyceride of 12-hydroxy stearic acid
2—dead burned gypsum
3—diatomaceous earth

Table 17

Ingredient	Parts by Weight	
	N-5	Semilive Simulant
Nitrocellulose, 12.6% N	50.00	54.19
Nitroglycerin	34.90	—
Di-n-butylphthalate	—	30.97
Di-(2-ethylhexyl) phthalate	—	10.90
Diethylphthalate	10.50	—
2-Nitrodiphenylamine	2.00	2.11
Lead salts	2.40	2.10
Candelilla wax	0.20	0.21

Analytical Aspects/Specification Requirements

As mentioned previously, waxes or waxy materials are complex mixts of a great variety of materials and/or a very broad range of organic compds. Quant and qual analysis of some of the natural waxes is very difficult and time consuming, and for the most part is not really necessary. Most of the waxes used in expl compns have been derived generally from petroleum sources. Specification requirements have been quite broad and are generally concentrated on the physical properties of the materials

The first US specification for wax used in expl compns was **PXS-1127**, (Dec 16, 1944). Accdg to Ref 34 this specification is largely a description of Aristowax 160-65 (Stream 2). This ref advises separation of the requirements for waxes into two classes - - Class A for use in pressed expls and class B for use in cast expls. Each of these classes would be further broken down into three grades representing the best wax that can be specified to the most inferior that can be accepted, which would be used only in emergencies. Only physical tests are suggested and only waxes from petroleum sources be considered for use. The following tests were recommended:

- 1) Melting point
- 2) Penetration test
- 3) Viscosity
- 4) Methylethylketone extraction
- 5) Sweating or exudation test

Present day requirements included in more than 8 different wax specifications include most of those mentioned above with the following additional ones:

- 1) Acid number
- 2) Saponification number
- 3) Ash
- 4) Flash point

Some of these tests cover very broadly the general chemical makeup of waxes. Constants such as acid, ester, saponification and iodine numbers can be used to identify, differentiate or classify waxes chemically (Ref 59). Specific tests are used to determine the values of these numbers for waxes. The saponification number generally indicates the total quantity of both esters and free acids in a wax. The acid value is an indication of the quantity of free fatty acids. The ester value is the relative quantity of esters

in a wax, and is generally regarded as the difference between the saponification number and the acid value. The iodine number indicates the amount of unsaturated fat or wax acids, esters, hydrocarbons and alcohols in the wax

In order that a wax be accepted for use as a desensitizer in an expl compn, it must not only meet the requirements of Specification **MIL-W-20553**, it must also be found acceptable in use tests. Such tests include characterization of a wax in the specific expl compn for incorporability, pressibility, sensitivity, physical compatibility, flow properties, cast shrinkage, etc. Examples of Army qualification work is contained in Refs 63, 87, 92 & 99. The qualification test procedures required by the Navy are spelled out in Ref 95. Specification **MIL-W-20553D**, paragraph 6.4.2 cites NWS TR-1 and TR-2 for qualification of waxes for Composition B and H-6 and D-2, respectively, and WS 13574, OD 45295 and WS 13564, OD 45001 for qualification of Compn A-3

The standard Vacuum Stability Test (VST) is used to judge chemical compatibility between materials. To determine compatibility, a comparison of the quantity of gases generated on heating waxes, in a vacuum, at 100°C or 120°C, with and without an equal quantity of RDX or TNT (in the case of Composition B) is made. The differences of the quantity of gas generated by the mixt and the sum of the gas generated by the materials alone is used to judge compatibility. Results of a variety of waxes tested for compatibility in this type test with TNT and with Amatol are contained in Ref 19. It is concluded from the results of this work that the 120°C VST is satisfactory for use in determining the reactivity of waxes with TNT, but that the 100°C VST is much more satisfactory for the testing of waxes with Amatol. Similar test results were observed in testing compatibility of various waxes for use as sealants in 750-lb bombs. Here the temp of the test was lowered to 90°C to screen materials for compatibility with MINOL-2. Apparently, amm nitrate (AN) is responsible for the increased reactivity. Ref 19 states that in tests with Amatol, waxes do not react directly with the AN, but that they serve to accelerate reaction between TNT and AN

The VST has been used almost exclusively for determining compatibility of expl materials with

other expls or inert materials for about 40 years. Work conducted in the last several years has indicated that the Differential Thermal Analyzer or the Differential Scanning Calorimeter may supplement or replace the VST in this respect

With the advent of the more sophisticated analytical techniques for determining the constituents of organic materials, efforts have been made to utilize them in defining waxes and waxy materials. Investigative work on waxes has been conducted using gas-liquid chromatography (Ref 72), thermogravimetric analysis (dynamic and isothermal), Differential Scanning Calorimetry and Differential Thermal Analysis (Refs 74, 84, 88, 90 & 96), and Gel Permeation Chromatography (Ref 110)

The objective of the work conducted and reported in Refs 88, 96 & 110 was to (1) try to determine what specific characteristics or materials in the wax are responsible for the great differences noted in the casting characteristics of Compn B, and (2) study the wax melting and cooling characteristics in relationship to that of TNT so that possible "matching" of the wax to the TNT (actually the TNT/RDX eutectic) can

be made. Also, results of work with the differential scanning calorimeter (Ref 96) could be utilized as a specification requirement as established in Specification MIL-W-20553D. After testing a large number of waxes and waxes with expls, it was recommended that the DCS method be used to determine liquification and solidification temps of commercial waxes to be used with expl compns. It was also recommended that a wax used as a desensitizer in a compn containing TNT have a melt temp of over 75°C and a solidification temp of 72°C to 78°C

Work covered in Ref 88 was conducted to determine the differences that existed between Indramic 170C wax, which when used in Composition B resulting in relatively poor expl cast charges, compared to the expl cast charges of Composition B in which a Grade A wax (WITCO 68835) was used. Work conducted involved hardness, dynamic and isothermal (300°C) TGA, DSC and fractionation tests. It was determined that the 170C wax is composed of several distinct molecular weight fractions in contrast to the WITCO wax. It is postulated that the higher molecular weight fraction of the

Table 18
"Standard" Explosives Containing Waxes

Explosive Designation	Composition, % by weight			
	RDX	TNT	Al	Wax
Composition B	59.5	39.5	—	1.0
Composition B-5	63	34	—	3.0 *
Torpex 2	41.6	39.7	18.0	0.7 Beeswax or Wax No 10
Torpex D-1	40	38	17	5 D-1 Comp
HBX	40	38	17	5 D-2 Comp
HBX-1	HBX w/0.5% CaCl ₂ added			
HBX-3	31	29	35	5 D-2 Comp and 0.5% CaCl ₂ added
H-6	45	30	20	5 D-2 Comp and 0.5% CaCl ₂ added
Composition A-3	91	—	—	9
Composition Z-4	97	—	—	3
Composition A-5	98.75	—	—	1.25 **
Composition A-6	86	—	—	14
Composition A-7	98.35	—	—	1.65 ***

* 2/1 Elastomer/glyceride of 12-hydroxy stearic acid

** Stearic acid

*** Proposed to be shipped dry, to be incorporated directly into TNT/Composition A-7 (39.5/60.5) to produce Composition B

170C wax becomes separated or fractionated in the remelting and casting process. This could lead to solidification and blocking of the filling apparatus (this would be the opening in the riser holding the molten reservoir of expl which provides additional molten material required to fill the void resulting from the shrinkage of the TNT portion of the compn on solidification)

The compn of US "Standard" expl formulations containing waxes are detailed in Table 18

Written by D. E. SEEGER

- Refs:* 1) M. Berthelot, "Explosives and Their Power", John Murray, London (1892) 2) Colver (1918) 3) A.F. Teitscheid, "Examination of Mk X Base Detonating Fuze Lot 2612-2", PATR 256 (1932) 4) J.A. Solomon, "Develop Improved Primer to Replace the 20 Grain Primer", PATR 339 (1933) 5) J.P. Wardlaw, "Tests with Fuze Setter in Connection with Fuze Cover Assembly Methods (105mm Howitzer Ammunition)", PATR 424 (1934) 6) J.M. King, "Develop Practice Loading of Weszycki Grenade", PATR 776 (1936) 7) Anon, Brit Spec CS/1078B (1939) 8) M.F. Crass, Jr, "A History of the Match Industry, Parts I-IX", J Chem Educ (Mar-Aug 1941) 9) G.B. Kistiakowsky & R.E. Elderfield, "Report on Properties and Performance of RDX", OSRD 136 (1941) 10) J.D. Hopper, "Development of an Inert Shell Filling for Practice Rounds", PATR 1136 (1941) 11) D.P. MacDougall, Progress Rept, "Beeswax Substitutes for Phlegmatization of Cyclonite", OSRD 313 (1941) 12) Ibid, Second Progress Rept on "Ibid", OSRD 397 (1942) 13) W.R. Tomlinson, "Study of Properties of RDX-Beeswax Mixtures Received from the National Defense Research Committee", PATR 1175 (1942) 14) D.P. MacDougall, Third Progress Rept on "Beeswax Substitutes for Phlegmatization of Cyclonite", OSRD 486 (1942) 15) E.H. Eyster & M.A. Paul, Progress Rept on "Composition B (Cyclotol)", OSRD 1167 (1943) 16) W.R. Tomlinson, Jr, "Develop New High Explosive Filler for AP Shot", PATR 1290 (1943) 17) R.D. Sheeline, "Loading of 3-Inch A.A. Shell to Increase Visibility of Burst", PATR 1308 (1943) 18) J. Rubin, "Properties of RDX Composition B Without Desensitizing Wax", PATR 1313 (1943) 19) W.H. Rinkenbach, "The Reactivity of Waxes with TNT and Amatol", PATR 1323 (1943) 20) Davis (1943) 21) W.R. Tomlinson, "Develop New High Explosive Filler for A.P. Shot", PATR 1380 (1944) 22) Ibid, PATR 1417 (1944) 23) J. Rubin, "Evaluation of Waxes as Substitutes for Aristowax in RDX Compositions A and B", PATR 1424 (1944) 24) Ibid, "Properties of RDX Composition B Without Desensitizing Wax", PATR 1435 (1944) 25) A.J. Clear "Cause and Prevention of Frothing of Molten TNT", PATR 1472 (1944) 26) J. Rubin, "Desensitization of High Explosives by Waxes", PATR 1489 (1945) 27) Ibid, Second Progress Rept on "Ibid", PATR 1499 (1945) 28) Ibid, Third Progress Rept on "Ibid", PATR 1533 (1945) 29) G.B. Kistiakowsky, "Introduction to Explosives", OSRD 5401 (1945) 30) F.H. Westheimer, "Waxes for HBX", OSRD 5573 (1945) 30a) J.M. Downard et al, "Sensitiveness of High Explosives", OSRD 5632 (1945) 31) F.H. Westheimer & J.W. Dawson, "Emulsifiers for HBX and HBX-1", OSRD 5597 (1945) 32) Anon, "Special Desensitizers (Composition D-1 and D-2)", Final Rept, Eastern Lab, Expl Dept, E.I. duPont de Nemours & Co, Contract W-670-ORD-4331(1945) 33) E.H. Eyster & C.A. Weltman, "The Preparation and Properties of RDX Composition A", OSRD 5626 (1945) 34) E.H. Eyster, "Specification of the Physical Properties of Desensitizer Waxes for Use in Explosives", OSRD 5533 (1946) 35) Ibid, "High Desensitized Cast Explosives", OSRD 5628 (1946) 36) Anon, "Japanese Explosive Ordnance", BuOrdn Publication, Dept of Navy Rept OP 1667 Vol 2 (1946) 37) A.J. Clear & O.E. Sheffield, "Inert Simulants for High Explosives", PATR 1618(1946) 38) S. Fleischnick, First Progress Rept", "Semi-Plastic RDX Compositions", PATR 1614 (1946) 39) H. Aaronson, "Semi-Plastic RDX Compositions", PATR 1634 (1946) 40) O.E. Sheffield, "Development of Inert Materials to Simulate Explosives", PATR 1667 (1947) 41) G.W. Weingart, "Pyrotechnics", 2nd Ed, Chemical Publishing Co, NY (1947) 42) Not used 43) S. Fleischnick, "Semi-Plastic RDX Compositions", PATR 1687 (1948) 44) E.K. Rideal & A.J.B. Robertson, "The Sensitiveness

Start 10-23

- of Solid High Explosives to Impact", Proc Roy Soc (London) (1948), 135-150 45) P. Varrato, "Investigation of Fertilizer Grade Ammonium Nitrate to Explosion", PATR 1720 (1949)
- 46) A.L. Forchielli & H.A. Aaronson, "Desensitized Explosives - RDX Composition B of Reduced Mechanical Sensitivity", PATR 1756 (1950) 47) H.A. Aaronson, "Desensitization of High Explosives by Waxes - Semi-Plastic RDX Composition", PATR 1761 (1950) 48) A.L. Forchielli, "Desensitization of High Explosives by Waxes - Semi-Plastic RDX Compositions", PATR 1787 (1950) 49) O. Ubbelohde, "Activation Process in the Sensitiveness of Explosives", Research 3-5, 207-12 (1950)
- 50) A.L. Forchielli, "Desensitized Explosives RDX Composition B of Reduced Mechanical Sensitivity", PATR 1865 (1952) 51) E.M. Solomon, "The Desensitization of High Explosives", Naval Research Lab Rept NRL 3964 (1952) 52) F.P. Bowden & A.D. Yoffe, "Initiation and Growth of Explosion in Liquids and Solids", Univ Press, Cambridge (1952)
- 53) L. Jablansky, "Investigation of Segregation in Composition B", PATR 2019 (1954)
- 54) Anon, "Microscopic Study of the Microstructure of Composition B", Phase Completion Report on Contract No DA-11-173-ORD-231, Armour Research Foundation (1954)
- 55) C.E. Jacobson, "Studies to Estimate Adherence of Semi-Plastic RDX Compositions to Pelleting Tools", PATR 2112 (1955)
- 56) D.K. Bleikamp, "Development of the T2021 1500 Lb Blast Warhead", PATR 2169 (1955)
- 57) C.E. Jacobson, "Segregation of Composition B in T108E45 90mm Shell", PATR 2151 (1955)
- 58) I.L. Kintish & P. Varrato, "Development of Inert Fillers Containing Polychloronaphthalene", PATR 2214 (1955) 59) A.H. Warth, "The Chemistry and Technology of Waxes", 2nd Ed, Reinhold, NY (1956) 60) C.E. Jacobson et al, "Evaluation of Waxes for Use in Composition A-3", PATR 2307 (1957) 61) C.E. Jacobson et al, "Evaluation of Materials for Use as Desensitizers in Composition B", PATR 2425 (1957) 62) N.Ye. Yaremenko et al, "Properties and Preparation of Explosives", CCM Information Corp, NY (1957), 37 63) J.A. Cussen, "Qualification of Desensitizing Waxes Based on Testing of Pilot Batches of Explosives", PicArnsn Rept DB-TR6-58 (1958) 64) W.O. Williamson, "The Microstructure of Some Cast Mixtures of Pentaerythritol Tetranitrate and 2,4,6-Trinitrotoluene", JApplChem 8 661-665 (1958) 65) Anon, "The Physical Properties of Explosives and Inert Materials Whose Physical Properties Resemble Those of Explosives", Journal of the JANAF Fuze Committee, Serial No 17.0 (1960) 66) J. Ayres et al, "Varicomp, A Method for Determining Detonation Transfer Probabilities", NAVWEPS 7411, NOL, White Oak, Silver Spring, Md (1961)
- 67) P.W. Linder, "Desensitization of Explosives", TransFaradSoc 57, 1024-1030 (1961)
- 68) Anon, EngrgDesHndbk, "Explosive Series - Solid Propellants, Part I", AMCP 706-175 (1964) 69) J. Eadie, "Toward an Understanding of the Function of Wax in the Desensitization of Explosives", AWRE Rept 0-15/65, United Kingdom Atomic Energy Authority (1965)
- 70) Anon, "Handbook of Foreign Explosives", FSTC 381-5042, US Army Foreign Science and Technology Center (1965) 71) J. Eadie, "The Effect of Wax on the Shock Sensitivity of Explosive Compacts", 4th SympDeton, Naval Ordn Lab, White Oak, Silver Spring, Md (1965), 399-403 72) F.J. Ludwig, "Analysis of Microcrystalline Waxes by Gas-Liquid Chromatography", AnalChem 37, 1732-37 (1965)
- 73) J.C. Cackett, "Monograph on Pyrotechnic Compositions", RARDE, Fort Halstead, Seven Oaks, Kent, Engl (1965) 74) A.P. Gray, "Characterization of Fats and Waxes by Differential Scanning Calorimetry", Instrument News 17(1), 8-9 (1966) 75) G.T. Afanas'ev & V.K. Bobolev, "Initiation of Solid Explosives by Impact", Academy of Sciences of the USSR, Moscow (1968) 76) H. Ellern, "Military and Civilian Pyrotechnics", Chemical Publ Co, NY (1968) 77) T.F. Watkins et al, "Chemical Warfare, Pyrotechnics and the Fireworks Industry", Pergamon Press, NY (1968) 78) Anon, "Research, Development, Test and Evaluation of Material for Extreme Climatic Conditions", US Army Reg AR 70-38 (1969) 79) Urbanski 1 & 3 (1967) 80) J.N. Ayres & C.W. Randall, "RDX/Calcium Stearate Binary System - Explosive Sensitivity Calibration", NOLTR 63-91 (1970) 81) A.S. Dyer & J.W. Taylor, "Initiation of Detonation by Friction on a High Explosive Charge", 5th SympDeton (1970), 296 82) R.L. Beauregard, "History of Navy Use of

- Composition A-3 and Explosive D in Projectiles", **NAVORD TR 71-1** (1971) 83) D. Price et al, "Explosive Behavior of a Simple Composite Propellant Model", *Combustn&Flame* **17**, 323-36 (1971) 84) B. Flaherty, "Characterization of Waxes by Differential Scanning Calorimetry", *JApplChemBiotechnol* **21** (5), 144-8 (1971) 85) C.W. Nelson & J.R. Ward, "Unsteady Heat Transfer in Erosivity Experiments", **BRL-MR-2176** (1971) 86) R. Lancaster, "Fireworks - Principles and Practice", Chemical Publishing Co, NY (1972)
- 87) J.M. Staples, "Desensitizing Wax Qualification", Development Rept No **M-23**, Holston Defense Corp, Kingsport, Tenn (1973)
- 88) J.J. Rocchio & J.O. Doall, "Analysis of Microcrystalline Waxes Used as Desensitizers in Composition B", **BRL Memo Rept 123** (1973) 89) T.S. Costain & R.V. Motto, "The Sensitivity, Performance and Material Properties of Some High Explosive Formulas", **PATR 4587** (1973) 90) Anon, "Thermal Analysis DTA/DSC/TGA Bibliography and Reference for Wax and Wax Related Materials" (30 Oct 1973) 91) R.C. Bowers et al, "Mechanisms Involved in Impact Sensitivity and Desensitization of RDX", *IndEngChemProdRes&Develop* **12** (1), 2-13 (1973) 92) D.E. Seeger, "Composition B Wax Study", Annual Mtg, Loading Section, Ammo Technol Div, American Defense Preparadness Assn (1974) 93) W. Brenner et al, "Optimization of Coatings for the M205 Non Metallic Cartridge Case for All-Temperature Use", Final Rept 1 Oct 72-1 June 74, Contract **DAAA21-73-C-0040**, New York Univ for PicArns (1974) 94) W. Brenner & J.J. Timlin, "Environmental Protection of Pyrotechnic Products and Devices", Rept No 4, Contract **DAAA21-73-C-0117**, Polytechnic Inst. of NY for PicArns (1974) 95) E.Y. McGann, R.M. Rountree & M.J. Sedonic, "Test Procedures for Qualifying Waxes for Use in Explosives", **NWSY TR 74-1**, NWS, Yorktown, Va (1974) 96) J. Harris, "Determination of Some of the Thermal Characteristics of Waxes Using the Differential Scanning Calorimeter", **PATR 4682** (1974) 97) J.E. Ablard, "HBX-1, Its History and Properties", **NAVSEA-03-TR-021**, Naval Sea Systems Command, Washington (1975) 98) J. Eadie & W.S. Wilson, "Esters of 2,4,6-Trinitrobenzoic Acid and the Interfacial Tension Between Wax and TNT", Rept **637**, Australian Defense Scientific Service, Maribyrnong, Victoria (1975) 99) R. Pellan & K. Russell, "Study of Melt Loading the 105mm MI Projectile with Composition B Containing Grade B Wax", **PATR 4854** (1975) 100) W.S. Wilson, "Wax Desensitizers", 5th Quadripartite Ammo Conference, Paper 3.2, Materials Res Labs, Australia (1975) 101) W.C. Hogge & E.R. Cousins, "Evaluation of Synthetic Waxes for Desensitizing Explosives", **NWSY TR-75-3** (1975) 102) R.T. Kemp & F.B. Anthony, "Synthesis of Waxes for the Phlegmatization of Explosives", **NSWC/DL TR 3364**, Naval Surface Weapons Center, Dahlgren, Va (1975) 103) F.J. Hildebrant, "Composition A-3 Desensitizer Replacement, Program GG37300 CTG, 105mm, HEP-T M393A2", Expls Applic Sect, Proplnts & Expls Applic Br, PicArns, Design Characteristic Technical Review (1976) 104) A. Fancher, Jr, "Composition A-3 Improvement Study - Manufacture of Composition A-3 Using Emulsified Waxes", Rept No **HDC-26-16**, Contract No **DAAA-09-73-C-0079**, Holston Defense Corp (1977) 105) Anon, Annex B to **AWRE-PERME-RARDE** Explosives Committee, Working Party on Use of Beeswax in TNT-Based Explosives (1977) 106) J.E. Ablard, "Composition B: A Very Useful Explosive", **NAVSEA-03-TR-058** (1977) 107) C.E. Gregory, "Explosives for Australasian Engineers", 3rd Ed, Univ of Queensland Press, Australia (1977) 108) D.H. Chamberlain, M.J. Pesko & R.H. Stresan, "Safety and Reliability Testing of Fuze Explosive Trains", **RSLR 78-4**, R. Stresan Lab Inc, Spooner, Wis (1978) 109) W.S. Wilson, "RDX/Polyethylene Wax Compositions as Pressed Explosives", Rept **MRL-R-722**, Australian Materials Research Labs, Melbourne, Victoria (1978) 110) W.J. Fisco et al, "The Behavior of Some Waxes in Composition B", **ARLCD-TR-98067**, ARRADCOM, Dover, NJ (1978) 111) F.J. Hildebrant & B.R. Banker, "Composition A-3 Desensitizer Replacement Program in Conjunction with Cartridge 105mm HEP-T M392A2", **ARLCD-TR-78076**, ARRADCOM, Dover, NJ (1979) 112) M.T. Mocella & J.R. Ward, "Thermomechanical Analysis of TiO₂-Wax Blend Used in Wear-Reducing Liners", Memo Rept **ARBRL-MR-02927** (1979) 113) D.S. Downs & L.E. Harris, "Relationship of Residue Formation to

Wax Used in M203 Propelling Charge Liners", ARLCD-TR-79042, ARRADCOM, Dover, NJ (1979) 114) D.S. Downs, L.E. Harris & K. Russell, "Part I of the Investigation of Residue from the 155mm M203 Propelling Charge", ARLCD-TR-80006, ARRADCOM, Dover, NJ (1981) 115) D.S. Downs, D. Ellington, L.E. Harris & K. Russell, "The 155mm M203 Propelling Charge Residue Investigation, Part II", ARLCD-TR-80007, ARRADCOM, Dover, NJ (1981) 116) Anon, British Specification, "RDX/TNT Type A and 1A", CS5446 (no date) 117) Anon, Rocket Propellant Description Sheet on Extruded Rocket Assisted Projectile for 155mm, M549 AFT Propellant Grain, Dwg No 7324786, Radford AAP, Radford, Va (no Date) 118) Anon, Paper AC 93, Phys/Ex 11, Ministry of Supply, Engl (no date)

Weapons. A man-made object (generally) which is intended as a means of killing or incapacitating humans or of destroying other objects

Strategic weapons are those capable of striking at the homeland of an opponent, that is, at his population and industrial centers. This is as opposed to *tactical weapons*, which are presumed to be usable only against a battlefield manifestation of the enemy. More generally the former are long-range and the latter short-range weapons, but the distinction has no precise meaning outside a specific context. *Conventional weapons* is an expression for all weapons other than biological, chemical or nuclear ones. *Defensive weapons* is a useful category; most of one's weapons are defensive, while those of the opposition are invariably *offensive*. *Weapons of mass destruction* is a preferred Soviet expression for nuclear, biological and chemical weaponry. Western usage is *ABC* (Atomic, Biological, Chemical) in Fr, and *CBR* (Chemical, Biological, Radiological) in the USA and UK. Nuclear weapons are either *fusion* (A-or atomic) or *fission* (H-or thermonuclear). *Special weapons* is a euphemism for chemical or biological weapons

Ref: E. Luttwak, "A Dictionary of Modern War", Harper & Row, NY (1971)

Weapons, Acoustic. Acoustic or sound waves have a mechanical mode of operation on the human ear. Vibrations transmitted through the air impinge upon the ear-drum (tympanic membrane) and set it in motion. This motion in turn stimulates the organs of the inner ear, generating nerve impulses which are interpreted by the brain as sound. The labyrinths of the inner ear are primarily concerned with registering the spatial orientation of the body, but very low frequency sounds (infrasound) of high intensity may affect the labyrinths, causing a feeling of vertigo, imbalance and other effects. It has also been suggested that at very low frequencies, resonances may be set up at other sites in the body, such as the heart, with various physiological effects, including possibly death, as a result. It appears that these phenomena have been investigated with a view to possible military applications (Ref 17)

As a result of the military demand for an extremely powerful amplifier, the Applied Electro-Mechanics Co of Alexandria, Va, produced the HPS-1 Sound System. It was used for airborne psychological warfare operations in Vietnam. With 350W power it can project a voice nearly 5km, and it is mountable on vehicles or helicopters. A number were purchased by the British Army for use in Northern Ireland (Ref 8). An accessory, known as the *Curdler*, projects a scientifically designed shrill, shrieking noise at irregular intervals at a decibel level just below that which causes pain, and it is intended for use as a riot-control weapon (Ref 2). The noise irritates people and interferes with collective activities, such as chanting or clapping

It has been suggested that a device of this kind could be used to transmit through separate loudspeakers two slightly dissimilar sound waves which would interfere to produce high and low resonances in the ultrasound and infrasound ranges (Ref 9). Although these frequencies would respectively be above and below the audible range, it is known that both ultrasound and infrasound can have physiological effects

Ultrasound (high frequency) devices are already marketed commercially as a means of clearing rodents from restaurants and other sites. The physical effects on rats and mice are sufficient to drive them from the area. Although intensity levels are selected to be relatively

harmless to human beings, the manufacturers warn that headaches, queasiness, and other discomforts can be felt if the device is left operating while the building is occupied. By making use of the Doppler effect, ultrasound devices are also used as alarm systems. Any movement in the area between a transmitter and a receiver causes a slight variation in the sound pattern received. This variation activates the alarm system. It is likely that this use of ultrasound will have great utility for military and other security purposes. It seems possible that at higher intensities, ultrasound could have more severe physiological effects (Ref 17)

Infrasound (low frequency) has several properties which could make it attractive as a weapon. First, its attenuation in the atmosphere or in solid materials is limited, so that it is able to travel long distances and to penetrate buildings (Ref 10). Secondly, experiments have shown that at intensities of about 100dB, infrasound has certain adverse physiological effects (Ref 15). These include disturbances to the nervous system, such as increased reaction times and impaired ability to perform simple sensory-motor tasks (Ref 3), momentary feelings of sickness (Ref 11), and disturbed balance (Ref 12). At 130-150dB the pain threshold is reached and feelings of sickness, vibration of the chest, disturbances of breathing and digestion, and tiredness arise (Ref 1). At 170dB, an experiment with dogs showed that breathing temporarily ceased (Ref 13)

At a meeting of the British Association for the Advancement of Science, the Director of the [British] Noise Abatement Society reported that at a research center in Marseilles, France, an infrasound generator had been built which generated waves at 7Hz. He said that when the machine was tested, people in range were sick for hours. The machine could cause dizziness, nervous fatigue, "seasickness", and even death up to 8km away (Ref 6)

Mironov (Ref 16) reports that intensive research is going on in the Soviet Union into possible peaceful uses of infrasound in medicine and engineering. Among the projects indicated is the possibility of using *directed* infrasound to break up polar sea-ice. Should a serviceable apparatus materialize it might also have military applications as an anti-personnel weapon (Ref 17)

Generators of random ("white") noise have been used, in combination with other measures, as a tool to break down the psychological resistance of prisoners during interrogation. The purpose of the noise in this case is twofold. Firstly, it is unpleasant and disturbing. Secondly, it prevents the hearing of other sounds enabling a person to orient himself, that is, it results in "sensory deprivation" (Ref 14)

It has been known for many years that the human brain is dependent for its normal functioning on a regular input of sensory stimuli. Sensory deprivation leads to hallucinations and finally to mental breakdown. The use of these sensory deprivation techniques by British forces in Northern Ireland (Ref 7) was the subject of an official investigation (Ref 4). This commission concluded that physical torture had not been used. But a commission set up by Amnesty International concluded that the technique "clearly amounted to brutality" and was "dangerous both to the immediate mental health of the individual subjected to this treatment and to the long-term health of some subjects" (Ref 5)

See also under "Sound as a Weapon" in Vol 9
 Refs: 1) G.C. Mohr et al, "Effects of Low Frequency and Infrasonic Noise on Men", *Aerospace Medicine* 36 (1965), 817-824 2) R. Applegate, "Riot Control", *Ordnance* (Sept-Oct 1969), 180-184 3) R.A. Hood & K. Kyriakides, "Some Subjective Effects of Infrasound", *Brit Acoustical Society Meeting on Infrasound and Low Frequency Vibrations*, Salford Univ (26 Nov 1971), 71-107 4) E. Compton, Ed, "Report of the Enquiry into Allegations against the Security Forces of Physical Brutality in Northern Ireland Arising out of Events on the 9th August, 1971", UK Home office, HMSO, London (1971) 5) Anon, "Report of an Inquiry into Allegations of Ill-treatment in Northern Ireland", Amnesty International, London (1971) 6) Anon, Associated Press, Leicester, Engl (9 Sept 1972) 7) N. Wade, *Science* 176 (1972), 1102-1106 8) Anon, *NewScientist* 20 (27 Sept 1973) 9) Anon, *NewScientist* 20 (20 Sept 1973) 10) L. Liszka, *Forskning och Framsteg* (3) (1973), 3-4 [Sweden] 11) P.V. Bruel & H.P. Olesen, "Infrasonic Measurements", *B.K. Technical Review* 3 (1973), 14-25 12) H.G. Leventhall, "Man-made Infrasound: Its Occurrence and Some

Subjective Effects", Colloquium on Infrasound, Paris (24-27 Nov 1973) 13) D.L. Johnson, "Effects of Infrasound on Respiration", Aerospace Medical Assn Annual Scientific Meeting (7-10 May 1973) 14) T. Shallice, "The Ulster Depth Interrogation Techniques and Sensory Deprivation Research", *Cognition* 1 (1973), 385-405 15) S. Händel & P. Jansson, *Läkartidning* 71 (16) (1974), 1635-1639 [Sweden] 16) A. Mironov, Ostersands posten (11 Oct 1976) [Sweden] 17) Anon, "Anti-Personnel Weapons", Stockholm International Peace Research Institute, Crane, Russak, NY (1978), 203-205

Weapons, Electric. In principle, electrical devices can be produced which can deliver powerful non-fatal shocks or lethal charges. Lethal electrical devices are used in slaughterhouses, and have been used for executing criminals, but have found little application as military weapons

In recent years a number of non-lethal devices have been utilized by police and military forces. Weapons based on the high voltage Tesla coil were used "apparently indiscriminately against blacks in several Southern states" of the USA in the mid-1960s but have "largely passed from the public scene as a result of extremely adverse publicity" (Ref 2). The same source reports that the West German police have an armored personnel carrier with a "gate-like prosthesis in the front which is charged to a high voltage". It is used to clear people from streets

The *Shok Baton*, made in the USA, imparts a high-voltage, low-amperage electric shock when applied to the skin, and is effective even through light summer clothes. It is powered by flashlight batteries, is made in various lengths, and can be used as a conventional wooden baton. It originated from military research to find an alternative to the bayonet in certain close-contact riot situations, and has since been supplied to paramilitary police forces in various countries (Ref 1). According to a report to the US National Science Foundation by the Security Planning Corporation (Ref 3), it aroused "widespread public outrage. . . when it was used by control forces during early civil rights marches", when it was likened to a cattle prod (Ref 1)

Electric generators, often of the type used in

field telephones, have been used as a means of torture during the interrogation of prisoners. This method was used, for example, by French forces in Algeria (Ref 4)

Another device produces an electrified water jet - this concept was patented in the USA in 1965. Two jets of water, one negatively charged and the other positively charged, are directed towards a point where they meet, closing the circuit. The device is intended as a barrier, or as a means of dispersing a crowd or disabling individuals. Although the technology is available, the device has not gained acceptance (Ref 9)

Patents for electric guns, spears, arrows and harpoons have been awarded over the last century, but few have come into operation. One of the more recent is the *taser*, patented in 1974 (USP 3803463). More than 2000 were sold in the USA in 1975 to private citizens as well as to security guards and police (Ref 6). It weighs 585g and looks like a flashlight, and indeed the upper portion does contain a flashlight. Underneath are two triggers which set off a gun powder charge which fires two small darts attached to wires about 5m long. The darts stick into the victim and conduct a charge of 50000 volts, but of low amperage, into his body. The effect is instant incapacitation, but in normal, healthy adults is without long-term effects. A cardiologist cited by Ferretti (Ref 6), expressed concern about the possible effects on persons with heart trouble or under stress. The Security Planning Corporation (Ref 3) pointed out that the taser might involve risks of infection, which had not been properly evaluated

The Taser received a considerable amount of publicity in the USA, particularly when it began to be used for crime. Because of this, a study was conducted by the Bureau of Alcohol, Tobacco and Firearms, and it was subsequently classified as a firearm, requiring registration (Ref 8). In Canada it was made a criminal offense to buy, sell or possess the Taser (Ref 7). Electric currents of high voltage and low amperage cause the muscles of the body to contract forcefully, and they may go into spasm. The contraction may fracture bones, and an affected person may be further injured if he collapses. Repeated shocks from a Taser for 10 seconds are said by the manufacturer to render a man unconscious (Ref 5). At higher amperage the resistance of the body

generates heat around the path of the current through the body. Electrical burns so caused are particularly difficult to treat because they may affect organs and tissues deep in the body (Ref 9)

Refs: 1) R. Applegate, "Non-lethal Police Weapons", *Ordnance* (July-Aug 1971), 62-66
 2) J.F. Coates, "Non-lethal Police Weapons". *Technology Review* 74 (7) (1972), 49-56
 3) Anon, "Non-lethal Weapons for Law Enforcement", Rept to Natl Science Foundation, Washington, DC (1972) 4) J. Massu, "La Vraie Bataille d'Alger", Plon, Paris (1972) 5) Anon, *Business Week* (29 July 1972) 6) F. Ferretti, "Zap!", *New York Times Magazine* (4 Jan 1976), 13-16 7) Anon, *Associated Press*, Ottawa (13 Jan 1976) (8) *Ibid*, Washington (21 Mar 1976) 9) Anon, "Anti-Personnel Weapons", *Stockholm International Peace Research Institute*, Crane Russak, NY (1978), 202-203

Weber Powder. Prepd by mixing either NC and K chlorate or Nitro Lignin and charcoal with oil
Ref: Daniel (1902), 803

Webley. Brit small-arms. The firm of Webley & Scott started in the 1830s in Birmingham when two Webley brothers set up as makers of parts for gun locks. They combined soon afterwards and in 1853 were advertising themselves as manufacturers of percussion revolvers. These were made in several styles, including a plain military model. In 1867 the firm was lucky enough to get a contract to supply the Royal Irish Constabulary with a solid-frame revolver of remarkable durability and reliability. It was a success and was adopted by other police forces all over the empire, setting an example for simplicity and robustness of its components. This feature was to remain a Webley hallmark for all their revolvers, and it made them ideally suitable for service in remote parts of the world. The RIC model went through many variants and different calibers, but the brothers were looking for improvements and were not afraid to buy other men's ideas

The Pryse patents for a hinged, self-extracting frame were bought in 1877, and a new line of revolvers put on the market without delay.

They were made in all calibers and all barrel lengths, and formed the basis of all the military models that were to follow. The Brit Army adopted the Webley-Pryse model in 0.442 inch (11.2mm) cal and called it the Webley Mark I. In 1899 the cal was changed to 0.455 inch (11.6mm) by which time the marks had reached IV, and this version continued in service until replaced by the 0.38 inch (9.7mm) in 1932, by when it was the Mark VI. The differences between the marks of military revolver were not great, but each one incorporated minor changes, particularly in the methods of manufacture. There were alterations in the barrel length and shape of the butt, and the Mark VI could be fitted with a shoulder stock

While the military revolvers were keeping the reputation of the company high among service users, the firm also produced large numbers of civilian models in all sizes and calibers ranging from pocket versions in 0.32 inch (8.1mm) up to long-barrelled target weapons with refined sights and hand-finished actions. The military contracts kept the firm going with long-term work, and the civilian products made a useful profit on top of that. When automatic pistols were introduced on the Continent in the late 19th century, Webley looked for suitable designs to manufacture. The Mars pistol was offered, but was quickly dropped and they set to work on their own design. The aim was to build a military pistol and the first one, in 1903, was in 0.455 cal. This had to be refined and development continued for the next six years resulting in the 0.32 of 1906, the 0.25 inch (6.4mm) Hammerless of 1909 and finally, in the 9mm (0.354 inch) of 1909. This last was a step in the right direction, though the two small-cal models were made and sold in reasonable numbers. The 9mm remained in production until 1930 and it was followed in 1912 by the first large-cal automatic of the Webley design that saw military service. This was a powerful and heavy locked-breech pistol of rather angular appearance and a somewhat finely made locking system

It was adopted by the Royal Navy, and later models were also taken by the Royal Horse Artillery, and at the same time the Royal Flying Corps., who were looking for a light automatic for the observers of two-seat aircraft, ordered a quantity with a light wooden shoulder

stock. The army preferred the revolvers, and very large numbers of these were turned out during WWI. Military revolver production ceased in 1932, when the army changed to a 0.38 cal, though civilian models have continued to be made, and numbers were produced for the army in WWII

Ref: B. Fitzsimons, Ed, "The Illustrated Encyclopedia of 20th Century Weapons and Warfare", Vol 24, Purnell Reference Books, Milwaukee (1979), 2589

Web Thickness. The shortest distance in a propellant grain through which burning can go to completion. In a solid cylinder this is for example the radius, or in the case of a plate half the thickness (the plate can, of course, burn from both sides). In a multiperforated grain, the web thickness average is the average of the inner and outer web thicknesses. Powder having a thicker web is slower burning and those with a thinner web are faster burning. Generally speaking, web thickness increases with the caliber, but shorter barreled weapons, such as the howitzer and mortar, require thinner webs to achieve complete burning and avoid formation of large "slivers"

Other factors influencing web thickness are:

- The larger the capacity of the powder chamber, the thicker the web of the grain
 - The heavier the projectile, the thicker is the web required, consistent with the maximum chamber pressure
 - The greater the muzzle velocity desired, the thicker is the web required, consistent with the maximum chamber pressure
 - As the maximum chamber pressure of any weapon should be constant, any increase in projectile weight or velocity will require a slower burning powder, one with a thicker web
- Refs: 1) Fordham (1966), 195 & 201
2) R. Meyer, "Explosives", Verlag Chemie, NY (1977)

Wedge Test (Detonation Failure Thickness). In this test, a wedge-shaped expl sample is confined on the bottom by a one-inch-thick brass plate and on the sides by ¼-inch-thick steel bars (Fig 1)

The wedge is usually one-inch-wide and, with side confinement, adequately represents a wedge of infinite width. High-density solid

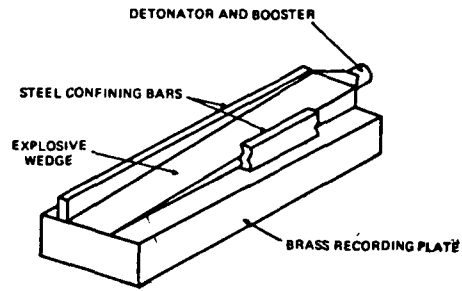

Fig 1 Minimum Failure Thickness Test Assembly (from Ref 4)

Table 1 (from Ref 4)
Detonation Failure Thickness

Explosive	Density (g/cc)	Failure Thickness (mm)
Pure Explosives		
Ammonium picrate	1.64	3.29
TNT	1.61	1.91 ^a
Castable Mixtures		
Comp A-3	1.63	0.57
Comp B-3	1.72	0.94
Cyclotol 75/25	1.75	1.51
Octol 75/25	1.79	1.43
Pentolite	1.70	1.39 ^b
Plastic Bonded Explosives		
<i>HMX-Based</i>		
PBX 9011	1.77	0.61
PBX 9404	1.83	0.46
X-0204	1.922	0.41
<i>RDX-Based</i>		
PBX 9010	1.78	0.52
PBX 9205	1.69	0.57
PBX 9407	1.77	0.30

^a Pressed at 65°C

^b Cast 50-mm wedge

expl samples are prepared most conveniently by gluing a rectangular expl prism to the brass plate and then forming the wedge by milling. The wedge thickness is measured at various distances from the end of the brass, the side plates are then glued on, and the charge is ready for firing. To minimize damage to the brass, it is backed by a heavy steel plate when the charge

is fired. A step in the brass plate indicates the location and thus the thickness of the expl at the point where detonation fails

The booster expl may cause an artificially energetic and rapid detonation, called overdrive, in the sample. To correct for overdrive, wedges with apex angles of 1,2,3,4, and 5° are fired, and the resulting failure thicknesses are plotted vs angle. A linear curve is fitted through the data and extrapolated to 0°, and the failure thickness at 0° is designated the detonation failure thickness. (Fig 1)

If the brass plate were completely incompressible, the failure thickness so determined would be half that of an unconfined infinite sheet. The failure thickness of an unconfined sheet is less than the failure diameter of a cylinder because rarefactions in a cylinder enter from all sides of the charge and influence the detonation. Thus, the failure diameter may be several times the failure thickness and may vary from one expl to another. More complete details are given in Ref 3

Refs: 1) W.E. Deal, J Chem Phys 27 (1), 796-800 (1957) 2) L.C. Smith, Explosivst 15, 106-110 & 130-134 (1967) 3) M.J. Urizar et al, Los Alamos Scientific Lab Rept LA-7193-MS (April 1978) 4) T.R. Gibbs & A. Popolato, Eds, "LASL Explosive Property Data", Univ of California Press, Berkeley (1980), 289-290

Wedge Test (Stock Initiation Properties).

Majowicz & Jacobs (Ref 1) and Campbell et al (Ref 2) first used the wedge test to study shock initiation of solid expls. The test is named for the wedge-shaped expl sample that is shocked by a booster-and-attenuator system as shown in Fig 1

The following explanatory material is taken from Ref 3: "The explosive is wedge-shaped so that the shock or detonation wave moving through it is visible along the slant face. The slant face and flat of the sample are covered with a thin aluminized plastic and are illuminated by an intense light source. A smear camera is aligned so as to record the light reflecting from the aluminized plastic. As the shock wave proceeds through the expl, the motion of the expl mass tilts the reflecting surface on the slant face so that the light is no longer reflected into the camera. This sharp cutoff of light gives a well-

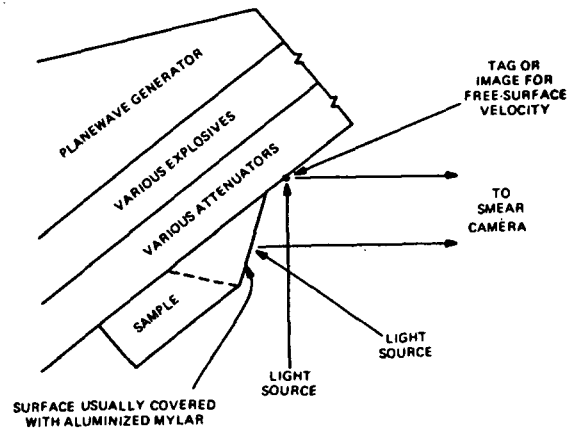

Fig 1 Experimental Arrangement for Most Wedge Test Shots (from Ref 3)

defined record of the shock or detonation location vs time. Usually, the shock wave appears to travel through the expl sample at a slightly increasing velocity and then to travel at a significantly higher velocity when detonation occurs. The point of interest is the distance into the sample, x^* , or time, t^* , at which detonation occurs.

The booster-and-attenuator system is selected to provide about the desired shock pressure in the sample wedge. In all but a few of the experiments on which data are presented here, the booster-and-attenuator systems consisted of a plane-wave lens, a booster expl, and an inert metal or plastic shock attenuator. In some instances, the attenuator is composed of several materials. The pressure and particle velocity are assumed to be the same on both sides of the attenuator-and-sample interface. However, because initiation is not a steady state, this boundary condition is not precisely correct. The free-surface velocity of the attenuator is measured, and the particle velocity is assumed to be about half that. The shock Hugoniot of the attenuator can be evaluated using the free-surface velocity measurement. Then, the pressure (P) and particle velocity (U_p) in the expl sample are found by determining graphically the intersection of the attenuator rarefaction locus and the explosives-state locus given by the conservation-of-momentum relation for the expl, $P = \rho_0 U_p U_s$, where U_s = shock velocity and ρ_0 = initial density. The attenuator rarefaction locus is approximated

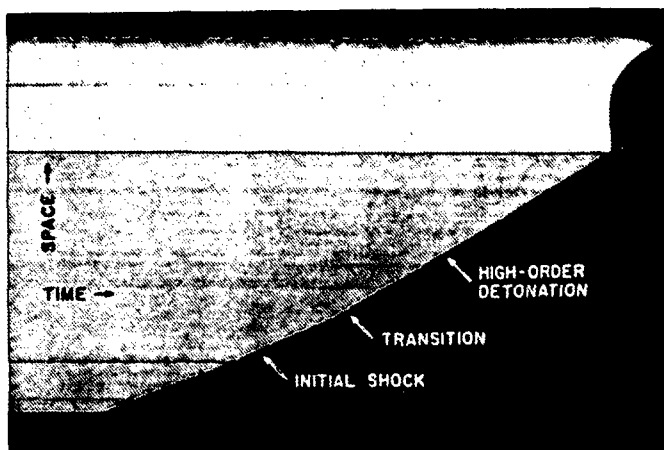

Fig 2 Typical Smear Camera Wedge Record

by reflecting the attenuator Hugoniot line about a line where the attenuator particle velocity is a constant. Because initiation is not a steady state, the conservation-of-momentum relation does not hold precisely; however, near the sample and attenuator interface, the reaction is slight enough that the accuracy is sufficient. Values of the initial shock parameters, P_0 , U_{p0} , and U_{s0} , are given in the tables that follow

Fig 2 shows a typical smear camera wedge record. Characteristically, these traces show the initial shock, the point of transition to high-order detonation, and the high-order detonation. The space and time dimensions are shown. Although the shock and detonation velocities in the expl can be determined from these records, only the coordinates for the high-order detonation, x^* and t^* , are normally found. Historically, many analysis techniques have been used, including those used here for data analysis".

The Techniques

Technique 1. In Technique 1, the *early average shock* velocity is determined from the angle generated on the camera record by the shock-wave progress along the wedge surface, the optical magnification, the wedge angle, the viewing angle, and the camera writing speed. The distance over which this measurement is made is kept as short as is practical. The distance and time of transition to high-order detonation are determined from the film measure-

ments, knowledge of the viewing angle, etc. In all the techniques described here, it is assumed that the shock wave is plane and parallel to the wedge-and-attenuator interface. The initial shock and particle velocity vs pressure in the wedge are obtained from a graphical solution involving the wedge density, early average shock velocity, and pressure in the last attenuator plate.

Technique 2. All wedges analyzed using Technique 2 had a flat portion extending beyond the end of the normal wedge face. The shock position was determined from ratios of disturbed vs undisturbed positions measured on the film image and wedge face. Times were obtained from the known writing speed of the camera and from film measurements. A film trace is obtained when the shock arrives at the free surface of the attenuator plate. Another is obtained when the detonation arrives at the free surface of the flat part of the sample. This latter trace is especially informative about the uniformity of initiation and helps to explain an occasional apparent overshoot. Phase velocities are measured at various positions on the wedge, depending on the specific record, and are analyzed by Technique 1. Each velocity is assigned to a midpoint of the interval over which the measurement is made, and the initial velocity is found by extrapolating the velocity vs thickness curve to zero thickness. The initial pressure and particle velocity are found from a graphical solution as in Technique 1.

Technique 3. In Technique 3, the shock position in the sample, x , is determined from 20–40 points using the same method of proportions as in Technique 2 and considering the wedge thickness and the length of the slant face image. The corresponding times, t , are determined from the known writing speed of the camera and from film measurements. When this technique was used, various equations were tested against the x - t data obtained from the wedge section of the sample. The equation $x = c(e^{kt} + t - 1)$ was chosen to fit the data from the partially reacting run. A plot of t vs $\ln(x - ct + c)$ produced a straight line of slope k if the proper c value was selected. Sensitivity of the fit to a chosen c was such that a poor choice was usually recognized, and a questionable choice had only a relatively minor effect on the first derivative evaluated at $t = 0$.

$$\left. \frac{dx}{dt} \right|_{t=0} = c(k + 1) = U_{s0}$$

The c is chosen best from a plot of the data for a shot with a long run to high-order detonation. The data used to evaluate c can come from an experiment in which the shock was accelerating, and high-order detonation need not be observed. The value of c is treated as a constant for that particular explosive formulation and density. This procedure typically gives a lower initial shock velocity value than does Technique 1.

Technique 4. When Technique 4 is used, the lighting of the flat face is adjusted to show particle paths after a shock front has passed. As in Technique 3, the smear camera record is measured and the measurements are converted to real times, t , and distances, x , for the shock traversing the wedge. Average velocities, x/t , are calculated for points before high-order detonation and are plotted against t . (Any inconsistent data near the beginning and end are rejected.) The data are then fitted with $x = U_{s0}t \pm 1/2 bt^2$ by the least squares method. The derivative evaluated at $t = 0$ is taken as the initial shock velocity. Thereafter, the analysis is like that in Techniques 2 and 3. The single-curve buildup hypothesis is checked by plotting, for each shot, the shock wave trajectory measured back from the transition to high-order detonation and superimposing the plots using the transition as a fiducial. Detonation velocities are obtained from x - t data mea-

sured in the high-order region.

Technique 5. In Technique 5, the driving plate free-surface velocity always is measured with electrical pin contactors. Buildup data from all experiments on a given density of explosive are pooled on the assumption of a single curve buildup and are fitted by the least squares method to the empirical function,

$$D = A_1 T^{(1-A_3)} [1 - \exp(-A_2 T^{A_3})] + (A_4 - A_1 A_2) T,$$

where D is the distance to detonation, T is the time to detonation at any point on the buildup curve, A_4 is the detonation velocity, and A_1 , A_2 and A_3 are arbitrary constants. The shock velocities are evaluated from the derivative of the above function,

$$U_{s0} = A_1(1 - A_3)T^{-A_3} [1 - \exp(-A_2 T^{A_3})] + A_1 A_2 A_3 \exp(-A_2 T^{A_3}) + A_4 - A_1 A_2,$$

using the coefficients fitted to the pooled data and the time to detonation, $T = t^*$, observed in the individual experiments. This shock velocity value is then used with the driving plate free-surface velocity determined as before

Technique 6. In Technique 6, a flash gap consisting of grooved Lucite blocks is used to measure the driving plate free-surface velocity. Also, shock velocities are determined by reading the average slopes from the streak records. Samples thus analyzed had two phase-velocity regions, the normal high-order detonation and an intermediate velocity region. The two abrupt changes in phase velocity are read from the streak records to give the distance to the intermediate region and the distance to detonation. All other analysis is done using Technique 5.

Technique 7. In Technique 7, the x - t data are digitized into 70 discrete points. A linear fit is made to three adjacent x - t points, and the slope is taken as the velocity at the midpoint of the line. Then one x - t end point is dropped, a new one is added on the other end, a new linear fit is made, and the velocity is found. This running linear least squares process is repeated until all 70 x - t points have been used. The u - x data are then extrapolated to zero thickness ($x = 0$) to find the initial shock velocity U_{s0} . All other analysis is done as in Technique 1."

Ref 3 contains 127 pages of data tables for some 55 energetic pure ingredients and/or formulations, taken primarily from unpublished in-

ternal LASL reports. The order of the Wedge Test results are given below:

Pure Explosives

HMX
 HMX (single crystal)
 Nitromethane (NM)
 Nitroguanidine (NQ)
 PETN (pressed)
 PETN (single-crystal)
 TATB (purified)
 TATB (micronized)
 TATB (superfine)
 Tetryl
 TNT (cast)
 TNT (single crystal)

Castable Mixtures

Baratol (76 barium nitrate, 24 TNT)
 Comp B (60 RDX, 40 TNT)
 X-0309 (Destex)

Plastic-Bonded Explosives

DATB Base

X-0300 (95 DATB, 5 Estane)

HMX Base

PBX 9501 (95 HMX, 2.5 Estane, 2.5 BDNPFA)
 PBX 9404 (94 HMX, 3 NC, 3 chloroethylphosphate)
 PBX 9011 (90 HMX, 10 Estane)
 LX-04 (85 HMX, 15 Viton)
 X-0219-50-14-10 (50 HMX, 40 TATB, 10 Kel-F 800)

NQ Base

X-0241 (96 NQ, 2 wax, 2 Elvax)
 95 NQ, 5 Estane
 X-0228 (90 NQ, 10 Estane)

PETN Base

XTX-8003 (Extex) (80 PETN, 20 Sylgard)

RDX Base

95 RDX, 2.5 wax, 2.5 Elvax
 PBX 9407 (94 RDX, 6 Exon)
 PBX 9405 (93.7 RDX, 3.15 NC, 3.15 chloroethylphosphate)
 X-0224 (74 RDX, 20 Al, 5.4 Elvax, 0.6 wax)
 X-0250-40-19 (40.4 RDX, 40.4 cyanuric acid, 19.4 Sylgard)

TATB Base

PBX 9502 (95 TATB, 5 Kel-F 800 (X-0290)
 95 TATB, 2.5 Kel-F 800, 2.5 Kel-F 827
 94 TATB (coarse), 6 Estane
 94 TATB (bimodal), 6 Estane
 94 TATB, 3 Elvax, 3 wax

94 TATB, 4.5 polystyrene, 1.5 dioctylphthalate
 92 TATB, 6 polystyrene, 2.0 dioctylphthalate
 90 TATB, 10 Estane
 X-0219 (90 TATB, 10 Kel-F 800)
 90 TATB, 5 Elvax, 5 wax
 90 TATB, 5 Kel-F 800, 5 Kel-F 820
 85 TATB, 15 Kel-F 800
 85 TATB, 7.5 Kel-F 800, 7.5 Kel-F 827

Propellants

FKM Class VII
 SPIS-44 Class VII
 SPIS-45 Class II
 TP-N1028 Class VII
 UTP-20930 Class VII
 VOP-7 Class VII
 VRO Class VII
 VRP Class VII
 VTG-5A Class VII
 VTQ-2 Class VII
 VTQ-3 Class VII
 VWC-2 Class VII

Note: See also under "Detonation, Transition from Shock to", in Vol 4, D625-L to D627-R and "Wedge Shots" in Vol 9, S63-L to S64-R
Refs: 1) J.M. Majowicz & S.J. Jacobs, American Physical Society Bull 3, 293 (1958) 2) A.W. Campbell, W.C. Davis, J.B. Ramsay & J.R. Travis, Physics of Fluids 4, 511-21 (1961) 3) T.R. Gibbs & A. Popolato, Eds, "LASL Explosive Property Data", Univ of California Press, Berkeley (1980), 293-424

Weight Strength. See under "Strength of Explosives" in Vol 9, S219-R to S220-R

Weight strength is determined by comparing the deflection of the pendulum of a Ballistic Mortar with that caused by an equivalent wt of blasting gelatine, arbitrarily taken as 100

The relationship between weight strength and the coefficient d'utilisation pratique (c.u.p.), usual in Fr (Pb block test), is given by the empirical formula:

$$\text{Weight strength, \%} = 0.645 \times \text{c.u.p., \%}$$

and

$$\text{C.u.p., \%} = 1.55 \times \text{weight strength, \%}$$

Refs: 1) R. Meyer, "Explosives", Verlag Chemie, NY (1977), 29 & 252 2) C.E. Gregory, "Ex-

plosives for Australasian Engineers", 3rd Ed, University of Queensland Press, Australia (1977), 6-7

Weiss-Salz (White Salt). A compd, $(\text{H}_2\text{C:N}\cdot\text{SO}_3\text{K})_3$, produced in 1944 by the IG Farbenindustrie at Höchst am Main, as an intermediate in the manuf of Hexogen. The compd was shipped to the Nobel plant at Hamburg, where it was nitrated. The production of white salt was stopped as soon as the method of direct nitration of hexamethylenetetramine to Hexogen was improved to make it more economical

Refs: 1) R.E. Richardson et al, CIOS Rept 25-18 (1945), 28-29 2) B.T. Fedoroff et al, "Dictionary of Explosives, Ammunition and Weapons (German Section)", PATR 2510 (1958), 226

Welgun. Brit submachine-gun. The Welgun was one of many Brit attempts during WWII to produce a very small and light submachine-gun. It was called for by the Special Operations Executive (SOE) which were at that time in Welwyn, hence the first part of the name. It was designed and built by BSA in Birmingham and the first military trials were in early 1943. From then on there were several trials, in all of which the Welgun fared quite well, but it was never adopted, not even for the SOE

The design used some Sten components. The barrel, magazine and return spring were Sten, but the design was more compact. The spring was around the barrel and two long plates ran forward from the bolt to a ring in front of the spring. There was a stop just in front of the breech, and rear movement of the bolt compressed the spring against this stop. The plates had serrations on them, and these were gripped to cock the weapon. The Sten magazine fed vertically upwards and the barrel was enclosed in a tubular jacket. The trigger mechanism was very simple, and the safety was an external rocking bar which held the bolt either open or closed. A simple folding steel stock was fitted

The bolt had a floating firing pin actuated by a plunger and rocking bar. When the bolt closed on the breech, the plunger was pushed and operated the rocking bar. This pushed the

firing pin forward to fire the cartridge

With a little development the Welgun could probably have been as good as the Sten, but by then the Sten was already in production

Caliber: 9mm (0.354 inch)

Ammo: 9mm Parabellum

Magazine: 32-round detachable box

Rate of fire: 650 rounds/minute

Muzzle velocity: 380m/sec (1250ft/sec)

Ref: B. Fitzsimons, Ed, "The Illustrated Encyclopedia of 20th Century Weapons and Warfare", Vol 24, Purnell Reference Books, Milwaukee (1979), 2590

Welin Screw. A type of gun-breech screw which has the surface divided into a number of segments which are struck with varying radii. The number of plain segments is less than half the total number, varying from one-third to one-quarter. Thus, the screw can be entered into the breech and locked by a fraction of a turn which corresponds to the number of segments; eg, the Brit 6-inch Gun Mk 7 screw had four threaded and two plain segments, and it was locked in place with one-sixth of a turn

The advantage of the Welin screw is that, due to the additional bearing surface obtained by having the segments of different radii, the necessary strength can be obtained with a short length of screw, and this, in turn, means that the screw can be swung from the breech aperture without having to be axially withdrawn. The short screw also means a shorter breech in the gun and this, in turn, reduces the gun weight

Ref: I.V. Hogg, "British and American Artillery of World War 2", Hippocrene Books, NY (1978), 256

Wellite. See under "Hebler Powder" in Vol 7, H59-R

Welrod. Brit WWII pistol. The Welrod was a small silenced pistol produced, like the Welgun (see above), exclusively for the Special Operations Executive. It was a remarkably successful weapon in its 0.32 inch (8.13mm) form, and it has been said that no other silencer has equalled it for efficiency. The pistol itself was quite crude

and was plainly never meant for extended use, but one could hardly expect that of an under-cover weapon. A steel sleeve extended over barrel and breech, with a slot for the ejection of the empty case. On this sleeve were two simple sights and a knurled cap at the back. A small magazine with a plastic coating formed the butt, and the trigger was a piece of bent metal. It was only a single-shot weapon, and the slide had to be manually worked for each shot. The silencer was just 10cm (4 inches) long and contained metal and rubber discs which trapped the muzzle gases before slowly venting them from the muzzle opening after the bullet had gone. There was no flash and no bang, and the bullet was subsonic (muzzle velocity 213m/sec) so that there was no crack from a shockwave

The official name for the Welrod was Hand Firing Device Mark I, and it was also tried in 9mm (0.354 inch) Parabellum and 0.45 inch (11.4mm) ACP. There were difficulties with both of these. The barrel was very short in the 9mm version, and inside the silencer was a perforated steel tube which dissipated the muzzle gases into the larger space of the silencer casing. The bullet was thus robbed of some propulsive force and left the other end of the silencer at below the speed of sound. The gas then followed it via a rubber disc, which slowed it down sufficiently to make sure that there was no noise. Despite the ingenuity the life of the silencers was short, and both the 9mm and the 0.45 inch ammo were too powerful for the little gun
 Ref: B. Fitzsimons, Ed, "The Illustrated Encyclopedia of 20th Century Weapons and Warfare", Vol 24, Purnell Reference Books, Milwaukee (1979), 2591

Weltérines. See under "Veltérines" in this Vol

Wendland's Explosive. Von Wendland patented a proplnt in 1886 prepd by mixing a collodion cotton gel in a volatile solvent with pulverized K chlorate. The resulting product was grained in the form of leaflets

Refs: 1) Daniel (1902), 769 2) Giua, Trattato 6 (1959), 394

Wenghöffer. German who in 1899–1900 patented expl and pyrot formulations contg finely/pulverized Al and Mg mixed with PA, K nitrate, etc. The same inventor proposed the manuf of PA starting with aniline and not with phenol, as was the usual procedure (USP 666627 of 1901)
 Ref: Daniel (1902), 626 & 803

Wenograd Test. See in Vol 7, K12-L & -R under "Kinetics in Explosion Phenomena"

Westfalit. A series of blasting expls used in Ger since 1893. The original composition contained Amm nitrate 95 and resin 5%. It was later modified to Amm nitrate 91, K nitrate 4 and resin 5%. This latter composition has a detonation vel of 4350m/s at a d of 1.01g/cc. It is called "Westfalit für Kohle" (Coal Westfalit)

Although Westfalit is fairly safe to use in gaseous coal mines, the Westfalisch-Anhaltische Sprengstoffe A-G proposed to add 3–5% of chromium salts to their formulations as cooling agents

Dynamites of this type are also manufd in Engl under the name "Westphalite", where they are Permitted expls which passed the Woolwich test

Refs: 1) Daniel (1902), 804–06 2) Marshall 1 (1917), 389 3) Barnett (1919), 113

Wettersprengstoffe (German Coal Mining Explosives Safe For Use in the Presence of Firedamp). A series of expls corresponding approximately to American "Permissible Explosives", British "Permitted Explosives", French "Explosifs Antigrisouteux", or Belgian "Explosifs S.G.P." (sécurité, grisou, poussière)

Table 1, which is a copy of Table 64 (from Ref 9, pp 260–61) lists primarily pre-WWII expls, while Table 2, which is a copy of Table 65 (from Ref 9, p 261) details some of their properties

Prior to WWII, the Wettersprengstoffe were divided into three groups:

A. Ammonsalpeter-Wettersprengstoffe (Ammonium Nitrate Permissible Explosives). They are marked as *Non-gel* (Nongelatinous) in Table 1

Table 1
Wettersprengstoffe

Designation	Composition %												Other Ingredients	Remarks	Refs	
	Am nitrate	Ba nitrate	MNN	NG	Wood Meal	DNT	TNT	K nitrate	Naphthalene	Carbon	K chloride	Na chloride				50% soln of Ca nitrate
W-Agesid A	27.0	-	-	30.0 (Gel)	-	-	-	-	-	-	38.0	-	-	Na nitrate 3.4 Mg silicate 1.6	Gel	2 & 4
W-Albit	Mentioned in Ref 1, p 428 but no composition was given.												-	-	-	
W-Ammoncahucit A	64.7	-	-	4.0 (Gel)	1.3	8.0	-	-	-	2.0	-	20.0	-	-	Non-gel	2 & 4
W-Ammoncahucit B	67.0	-	-	4.0 (Gel)	1.5	6.0	-	-	-	1.5	-	20.0	-	-	Non-gel	2 & 4
W-Ammoncahucit D	Marshall, v 3, p 121 lists them as having compositions similar to W-Ammoncahucites A and B and W-Detonite												-	-	-	
W-Ammoncahucit E	29.5	-	-	25.8 (Gel)	-	3.7	-	-	-	-	-	40.0	-	Glycerin 1.0	Gel	2 & 4
W-Arit A	31.0	-	-	25.8 (Gel)	-	4.2	-	-	-	-	-	38.0	-	Glycerin 1.0	Gel	2 & 4
W-Arit B	57.0	-	-	12.0 (Gel)	2.0	2.0	-	-	-	-	-	27.0	-	-	Semi-gel	2 & 4
W-Astralit A	74.5	-	-	4.0 (Gel)	1.0	7.0	-	-	-	1.0	-	10.0	-	Vaseline or Paraffin 2.5	Non-gel	6
W-Astralit of pre-WWI	50.0	-	-	12.0 (Gel)	2.0	2.0	-	-	-	0.5	-	33.5	-	-	Semi-gel	4
W-Baldurit A	25.0	3.0	-	30.5 (Gel)	-	0.5	-	-	-	-	40.0	-	-	Talc 1.0	Gel	4
W-Barbarit A	24.0	2.5	-	30.0 (Gel)	-	-	-	-	-	-	-	41.5	-	Talc 1.0 Glycerin 1.0	Gel	4
W-Barbarit B	55.0	-	-	12.0 (Gel)	1.0	3.0	-	-	-	1.0	-	28.0	-	-	Semi-gel	4
W-Bavarit A	56.0	-	-	12.0 (Gel)	-	2.0	-	-	-	-	-	28.0	-	-	Semi-gel	4
W-Bavarit B	56.0	-	-	12.0 (Gel)	-	2.0	-	-	-	-	-	28.0	-	-	Semi-gel	4

(continued)

Table 1 (continuation)

Designation	Composition %													Remarks	Refs	
	Am nitrate	Ba nitrate	MNN	NG	Wood Meal	DNT	TNT	K nitrate	Naphthalene	Carbon	K chloride	Na chloride	50% soln of Ca nitrate			Other Ingredients
W-Carbonit A	26.5	-	-	30.0 (Gel)	0.5	-	-	-	-	-	-	40.0	3.0	-	Gel	2 & 4
W-Dahmenit A	81.0	8.0	-	4.0	1.0	-	2.0	-	-	-	4.0	-	-	-	Non-gel	2 & 4
W-Detonit A	82.0	-	1.0	4.0	2.0	-	-	-	-	0.5	10.5	-	-	-	Non-gel	2 & 4
W-Detonit B	81.0	8.0	-	4.0	1.0	-	2.0	-	-	-	4.0	-	-	-	Non-gel	2 & 4
W-Detonit C	64.5	-	-	4.0	1.5	-	7.0	-	-	-	-	23.0	-	-	Non-gel	5
W-Donanit A	82.0	-	1.0	4.0	2.0	-	-	-	-	0.5	10.5	-	-	-	Non-gel	2 & 4
W-Donarit B	81.0	8.0	-	4.0	1.0	-	2.0	-	-	-	4.0	-	-	-	Non-gel	2 & 4
W-Donarit A (1936)	See under Commercial Explosives of WWII													-	-	
W-Dynamit No 1	-	-	-	30.0	6.0	-	-	-	2.0	-	-	-	-	Na nitrate 31.0 Alum 1.0 Flour 30.0	Non-gel	Barnett, Explosives (1918), p194
W-Dynamon	94.0	-	-	-	-	-	-	-	-	4.0	-	-	-	-	Non-gel	Marshall, v1, p392
W-Fordit A	75.0	-	-	4.0	2.0	-	-	-	-	0.75	18.25	-	-	-	Non-gel	2 & 4
W-Fulmenit	76.5	-	-	-	-	-	5.5	-	-	1.5	-	10.0	-	Guncotton 4.0 Paraffin Oil 2.5	Non-gel	Marshall, v1, p391
W-Lignosit A	62.0	-	-	4.0	4.0	0.7	6.3	5.0	-	-	-	18.0	-	-	Non-gel	2 & 4
W-Lignosit B	61.5	3.0	-	4.0	4.0	5.0	-	-	-	-	-	22.5	-	-	Non-gel	2 & 4
W-Lignosit C	Marshall, v3, p 121 lists this explosive but does not give the composition													-	-	
W-Lignosit D	82.0	-	-	4.0	1.0	1.5	-	-	-	-	-	11.0	-	-	Non-gel	5
W-Markanit A	32.0	-	-	26.0	1.0	2.0	-	-	-	-	-	36.5	2.5	-	Gel	2 & 4
W-Monakit A	Marshall, v3, p 121 lists both W-Monachites as non-gelatinized explosives similar to W-Ammoncahutes, W-Detonites, W-Lignosites and W-Westfalites													-	-	
W-Monakit B	32.0	-	-	26.0	1.0	2.0	-	-	-	-	-	-	-	-	-	-
W-Nobelit A	-	-	-	(Gel)	-	-	-	-	-	-	-	-	-	-	Gel	2, 4 & 6

(continued)

Table 1 (continuation)

Designation	Composition %													Other Ingredients	Remarks	Refs	
	Am nitrate	Ba nitrate	MNN	NG	Wood Meal	DNT	TNT	K nitrate	Naphthalene	Carbon	K chloride	Na chloride	50% soln of Ca nitrate				
W-Nobelit B	26.5	-	-	30.0 (Gel)	0.5	-	-	-	-	-	-	40.0	3.0	-	-	Gel	2, 4 & 6
W-Nobelit C	29.3	-	-	24.7 (Gel)	1.0	2.0	-	-	-	-	-	38.0	5.0	-	-	Gel	2 & 4
W-Nobelit A (1932)	See under Commercial Explosives of WWII																
W-Nobelit B (1932)	32.0	-	-	-	3.0	8.0	-	-	-	-	-	23.00	-	K perchl DNN	30.0	Non-gel	1
W-Perchlorit I	34.0	-	-	-	3.0	10.0	-	-	-	1.0	-	22.0	-	K perchl	30.0	Non-gel	1
W-Perchlorit IV	Marshall, v1, p 384 mentions this explosive but does not give its composition																
W-Persalit	57.0	-	-	12.0 (Gel)	2.0	-	-	-	-	1.5	27.5	-	-	-	-	Semi-gel	5
W-Salitr A	57.0	-	-	12.0 (Gel)	2.0	-	-	-	-	2.0	-	27.0	-	-	-	Semi-gel	4 & 6
W-Siegrit A	81.0	8.0	-	4.0 (Gel)	1.0	-	-	-	-	-	4.0	-	-	-	-	Non-gel	2 & 4
W-Sonnit A	20.0	10.0	-	28.0 (Gel)	-	-	2.0	-	-	-	40.5	-	-	Gelose Talc	1.0	Gel	2 & 4
W-Wasagit B	36.0	-	-	26.0 (Gel)	0.3	1.35	1.35	-	-	-	35.0	-	-	-	-	Gel	2 & 4
W-Wasagit A of WWII	See under Commercial Explosives of WWII																
W-Wasagit B of WWII	84.0	2.4	-	4.0	-	-	-	-	-	-	8.0	-	-	-	-	Non-gel	2 & 4
W-Westfalt A	82.0	-	-	4.0	1.5	-	-	-	1.6	-	11.0	-	-	-	-	Non-gel	2 & 4
W-Westfalt B	80.0	2.0	-	4.0	2.0	-	1.5	4.0	-	-	5.0	-	-	m-MNT	1.5	Non-gel	2 & 4
W-Westfalt C	See under Commercial Explosives of WWII																
W-Westfalt A of WWII	35.0	-	-	15.0 (Gel)	-	-	-	-	-	-	-	23.0	-	Cellulose Na nitrate	12.0 15.0	Semi-gel	5

Abbreviations: **Am** Atmosphere; **DNN** Dinitronaphthalene; **DNT** Dinitrotoluene; **Gel** Gelatinous explosive; **m-MNT** m-Mononitrotoluene; **MNN** Mononitronaphthalene; **NC** Nitrocellulose; **NG** Nitroglycerin; **Non-gel** Non-gelatinous explosive; **perchl** perchlorate; **Semi-gel** Semi-gelatinous explosive; **TNT** Trinitrotoluene; **W Wetter** (firedamp)

Note: Most of the explosives in Table 64 were on the "Liste der Bergbau Sprengstoffe" (List of Mining Explosives) used prior to WWII

Table 2
Properties of Some Wetter-Sprengstoffe

Explosive	Oxygen Balance %	Density of Charge	Veloc of Deton, m/sec	Trauzl Test (Lead Block Expansion) cc	Sensitive-ness to Initiation Requires at least:	Gap Test, (using 30mm cart-ridges)	Heat of Explo-sion, kcal/kg	Temp of Explo-sion, °C	Vol of Gases in ℓ /kg at 20°C & 760mm	Specific Pres-sure (f) * atm- ℓ /kg	Brisance (B) ** (by Kast for-mula)	Brisance (by Pb block crushing) mm	Ref
W-Astralit A	+4.1	1.21	3800	210	No 1 cap	25mm	601.0	1738	—	—	—	10.0	2
W-Dahmenit A	+16.1	1.06	3650	220	No 3 cap	40mm	462.0	1388	821.0	5300	17200	8.3	2
W-Detonit A	+10.9	1.04	3600	230	No 3 cap	40mm	548	1520	—	—	—	8.5	2
W-Detonit A	+10.4	1.06	3000	215	—	—	516.0	1730	772.3	5853	18600	10.5	7
<i>Note: No composition of this second W-Detonit A could be found in any of the sources at our disposal</i>													
W-Detonit B	Same as for W-Dahmenit A												
W-Detonit C	—	1.05	3200	—	—	—	531.0	1490	763.0	4740	15900	—	5
W-Donarit A	Same as for W-Detonit A												
W-Donarit B	Same as for W-Dahmenit A												
W-Dynamit 1	—	1.16	3900	—	—	—	—	—	—	—	—	—	Barnett, p 194
W-Lignosit D	—	1.04	3000	—	—	—	518.0	1480	911.0	5620	17500	—	5
W-Novelit B	—	1.7	5650	—	—	—	568	1615	538.0	3690	35400	—	5
W-Salit A	—	1.1	3300	—	—	—	607.0	1830	711.0	5300	19200	—	5
W-Sonnit A	Same as for W-Detonit B												
W-Zellit A	—	0.6	3000	—	—	—	937.0	2630	—	6370	11500	—	5

* Specific pressure (Spezifisches Druck), (f) is calculated according to the formula given on p 51 of Ref 5

** Brisance by Kast (Brisanzwert nach Kast), (B) is calculated according to the formula given on p 57 of Ref 5

Table 3
Current German Federal Republic Permitted Explosives

Wetter-	Manufacturer	Density, g/cc	Weight Strength, %	Safety Class ^a	Remarks
Carbonit C	Dynamit Nobel	1.18	37	III	b
Devinit A	Wasagchemie	1.25	18	III	b & c
Energit B	Dynamit Nobel	1.17	38	II	b
Nobelit C	Dynamit Nobel	1.7	44	I	gelatinous
Roburit B	Wasagchemie	1.20	38	II	b
Securit C	Wasagchemie	1.18	37	III	b
Wasagit C	Wasagchemie	1.7	44	I	gelatinous

^a See Ref 10, pp 292–93, Ref 11 & Ref 12, pp 212–13 for a discussion of current Ger safety classes

^b The powder form expl is cartridge and inserted in plastic hoses. All class II and class III expls are ion exchange types

^c Can also be used for smooth blasting and metal plating shots

B. Nitroglycerin-Wettersprengstoffe (Nitroglycerin Permissible Explosives). They are marked as *Semi-gel* (Semigelatinous) in Table 1

C. Gelatinose-Wettersprengstoffe (Gelatinous Permissible Explosives). They are marked as *Gel* (Gelatinous) in Table 1

The (A) group included powdery compns with an NG content less than 5% and a density of approx 1.0g/cc. They were suitable for blasting soft coal. Wetter-Ammoncahücit, W-Astralit, W-Detonit, W-Lignosit, W-Monachit and W-Westfalit belonged to this group

The (B) group included partly gelatinous but not plastic compns contg 12–15% NG–NC gel and had a density of approx 1.3g/cc. They were suitable for blasting hard coal and rock seams, and included Wetter-Baldurit A, W-Bavarit A, W-Salit A and W-Siegrit

The (C) group included gelatinous (plastic) compns which contd approx 30% NG–NC gel and had densities of up to 1.7g/cc. They were suitable for blasting hard rock. Wetter-Arit A, W-Barbarit, W-Carbonit, W-Nobelit and W-Wasagit belonged to this group

Accd to Marshall (Ref 3, Vol 3, p 123), Ger coal mining expls contd a large excess of oxygen. This achieved two purposes: a) it lowered the brisance of an expl so that the coal would not be broken into very small pieces; and b) it avoided the formation of CO, which is very toxic. Too large an excess of oxygen had to be avoided, however, because this favored the for-

mation of NO₂ which is also toxic

In Table 3 Meyer (Ref 12) gives the syntopical view of all current German Federal Republic permitted expls prefixed by "Wetter"

Meyer in Ref 10, details the expl properties of Wetter-Roburit A, W-Salit A, W-Securit C, W-Wasagit B, W-Wasagit W and Wetter-Westfalit A

Refs: 1) Naoúm, Expls (1927), 147 2) Ibid, NG (1928), 389, 414–16, 428, 436–39 & 444 3) Marshall 1 (1917), 391–92 & 3 (1932), 121–23 4) Pepin Lehalleur (1935), 411–14

5) Beyling & Drekopf (1936), 32 & 100–05

6) Thorpe, Vol 4 (1940), 554–56 7) P.

Naoúm, SS 39, 54 (1944) [Table giving props of Wetter-Detonit A and Wetter-Nobelit A]

8) Stettbacher (1948), 91 9) B.T. Fedoroff

et al, "Dictionary of Explosives, Ammunition and Weapons (German Section)", PATR 2510 (1958), 226 & 260–62 10) R. Meyer, "Explosivstoffe", Verlag Chemie, Weinheim (1975), 289–96 (in Ger)

11) R. Germershausen et al, "Waffentechnisches Taschenbuch", Rheinmetall GmbH, Dusseldorf (1977), 34–35 (in Ger) 12) R.

Meyer, "Explosives", Verlag Chemie, NY (1977), 212–13 & 317 (in Engl)

Wetzler Powder. Nineteenth century proplnt contg Na nitrate 68.7, spent tan bark 18.7, sulfur 11.8 and moisture 2.8%

Ref: Daniel (1902), 807

Weyel Explosives. Patented in Ger in 1895, were based on a mixt of NG and coal tar (creosote) in order to lower the freezing pt of NG. A typical blasting expl contd NG 27.0, creosote 4.5, collodion cotton 1.0, Na nitrate 53.0, rye flour 9.0 and Na bicarbonate 5.5%

Ref: Daniel (1902), 808

Wheeler's Explosive. Amm nitrate 88, DNN 8 and TNT 4% are mixed at a temp between 138° and the mp of the Amm nitrate

Ref: P. Wheeler, USP 901504 (1908) & CA 3, 592 (1909)

Wheel-lock. Small-arm firing mechanism developed early in the 16th century. Its intricate parts, working on the principle of a modern cigarette lighter, were mounted on a large lockplate with the wheel roughly in the center, its upper edge coming thru a slot in the bottom of the priming pan. Ahead of the wheel, pivoted at the front of the lockplate, was a large arm called the dog, which held a piece of iron pyrites in its jaws at one end, called the doghead. The dog was held in position by a V-shaped spring beneath it. The lock was spanned (made ready to fire) by using a tool resembling a piano tuner's key called a spanner. This was placed over a square external end of the wheel spindle and turned about three-quarters of a turn, until the sear caught in a notch on the inner surface of the wheel. The wheel spindle was linked to the mainspring by a short chain. Priming was placed in the pan, over the wheel, and the pan cover closed. To fire, the dog was pulled back onto the pan cover and the trigger pulled. The wheel revolved rapidly, the pan cover flew back, and the wheel made sparks on the pyrites, igniting the priming

The wheel-lock, while reliable, was complicated and therefore expensive. It did not, for these reasons, replace the matchlock (see Vol 8, M41-L) in general usage, being reserved for wealthy sportsmen and certain troops

Ref: C. Chant, Ed, "How Weapons Work", Henry Regnery & Co, Chicago (1976), 19-20

Whiplash. South African air-to-air missile, in production. Development started in 1966 of a missile that was said, by the South African Minister of Defense in 1969, to be purely a South African venture. The missile was tested successfully at the St Lucia missile range in 1969, and in Sept 1971 a missile launched from a Mirage III fighter successfully attacked a target flying at Mach 2. Limited production is believed to have started in late 1972, under the name *Whiplash*

Ref: M.J.H. Taylor & J.W.R. Taylor, "Missiles of the World", Charles Scribner's Sons, NY (1976), 155

Whistles, Pyrotechnic. US projectile ground-burst and booby-trap flash simulators precede their flash and expln with a whistling sound. The fact that certain compns whistle when compressed into a tube and ignited has been used in the fireworks industry for many years. The active substance most often used in pyrot whistles is gallic acid (3,4,5-trihydroxybenzoic acid). The K salts of benzoic acid; of 2,4-dinitrophenol; and of picric acid (2,4,6-trinitrophenol); and the Na salt of salicylic acid (o-hydroxybenzoic acid) are also effective. They are combined with K chlorate, K perchlorate or K nitrate (see Table 1)

Table 1 (from Ref 2)
Whistling Compositions

Formula No	156	157	158	159	160
K chlorate, %	73	—	—	—	—
K perchlorate, %	—	—	70	—	72.5
K nitrate, %	—	50	—	30	—
Red Gum, %	3	—	—	—	—
Gallic Acid, %	24	—	—	—	—
K picrate, %	—	50	—	—	—
K benzoate, %	—	—	30	—	—
K dinitrophenate, %	—	—	—	70	—
Na salicylate, %	—	—	—	—	27.5

The origin of these whistle mixts and the discovery of their peculiar properties are obscure. Maxwell (Refs 1 & 3) has studied pyrot whistles extensively and written the definitive treatise on their behavior and probable mechanism of sound production. He made most of his measurements with a 70/30 K perchlorate/K benzoate mixt, but

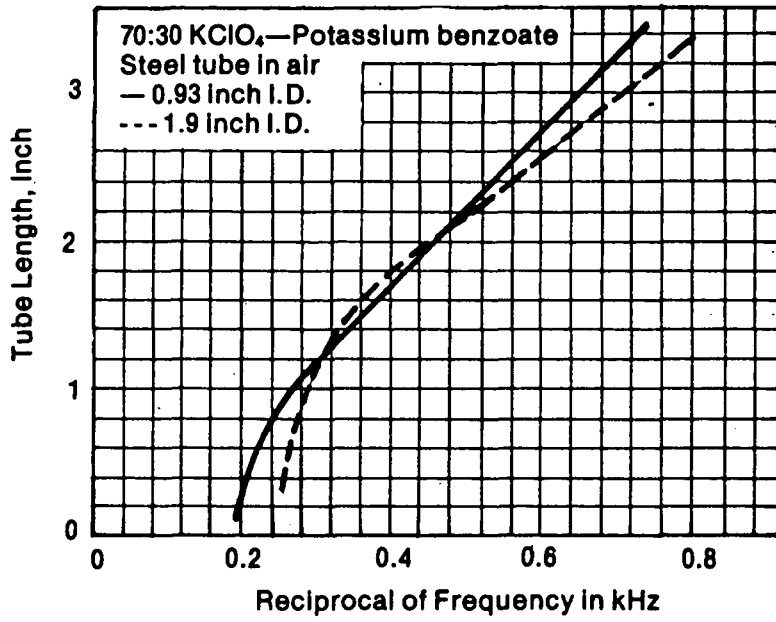

Fig 1 Effect of Open Tube Length on Whistle Frequency

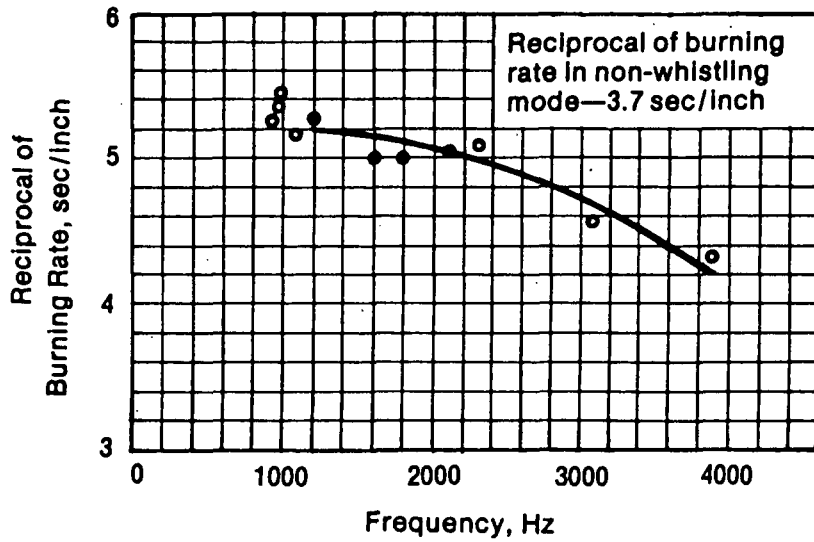

Fig 2 Effect of Whistle Frequency on Burning Rate

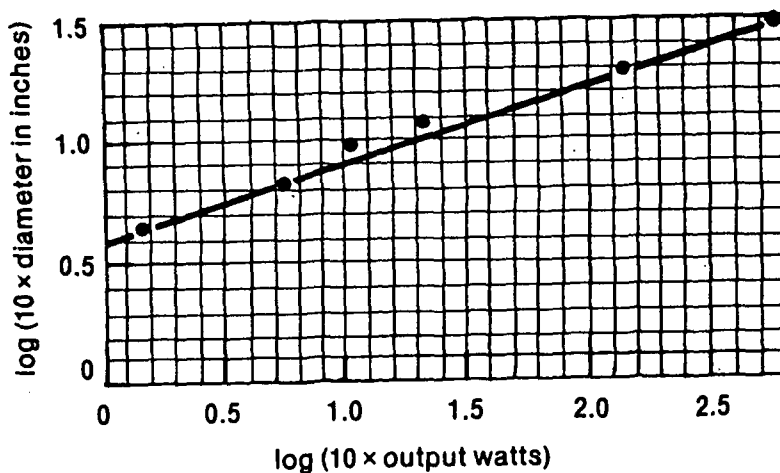

Fig 3 Effect of Whistle Diameter on Acoustic Output

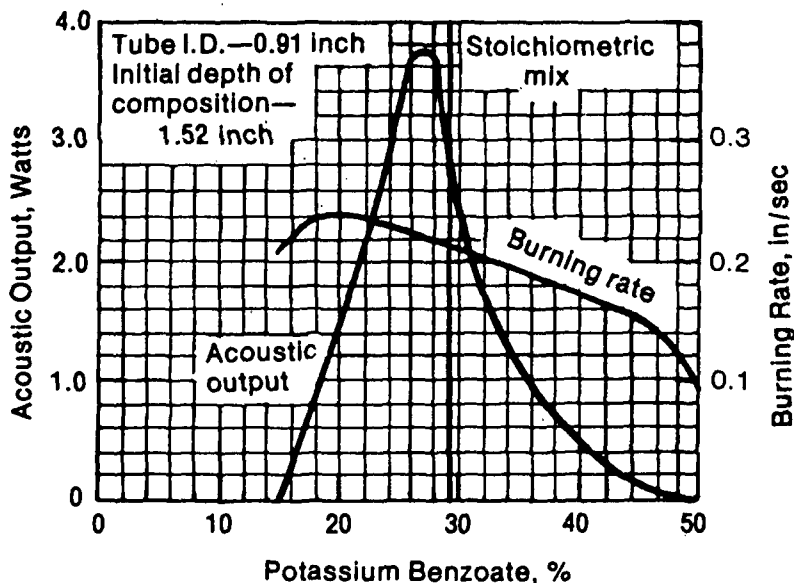

Fig 4 Effect of Whistle Composition on Acoustic Output and Burning Rate

also investigated mixts of 60/40 K picrate/K nitrate, 25/75 gallic acid/K chlorate, and 70/30 K dinitrophenate/K nitrate. His most important findings are depicted in Figs 1 thru 5 (from Refs 1 & 3)

Fig 1 shows that the frequency of the main component of the sound falls continuously as the length of the tube above the burning surface increases. Maxwell constructed a constant-frequency whistle by applying the "coachman's

lamp" principle. He used a telescoping case with the upper portion resting on a shoulder of the burning mixt. As the mixt was consumed, the upper case descended, maintaining a constant "throat". Fig 2 shows that the mixt burns faster at higher whistle frequencies, and burns fastest if not constrained to whistle at all

Acoustic output (Fig 3) increases somewhat faster than the cube of the diameter. Maximum acoustic output for the K perchlorate-K benzo-

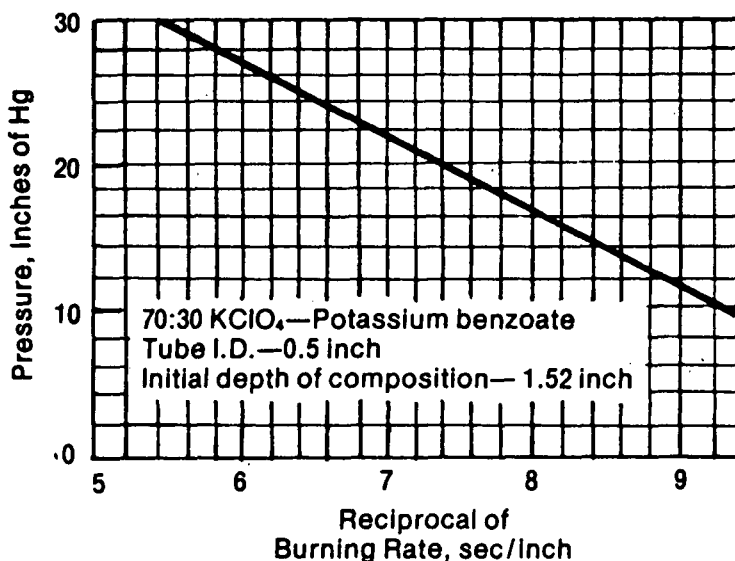
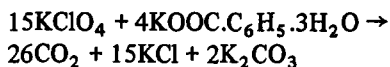

Fig 5 Effect of Pressure on Whistle Burning Rate

ate system, as indicated in Fig 4, occurs at critical proportions of the ingredients. The proportions do not produce the maximum burning rate but correspond closely to stoichiometry for the reaction:



This is a mixt of 70.8% K perchlorate and 29.2% K benzoate

K picrate—K nitrate proportions for maximum sound were less critical. The commercial production process at the Kent Manufacturing Corp, Chestertown, Md, consisted of bringing water to a boil with live steam in a 55-gal drum; stirring in picric acid to saturation; adding small increments of solid K carbonate and stirring until effervescence ceased; stirring in an amount of K nitrate equal to about one-third the weight of picric acid; then cooling and filtering the soln. K nitrate additions to the hot K picrate soln enhanced crystn by means of the salting-out and common-ion effects. The resulting crystalline meal was dried and gave good results in whistle devices (Ref 3)

Fig 5 (from Refs 1 & 3) shows that the burning rate of the whistle mixt decreases as the surrounding pressure falls

Maxwell (Ref 3) observed that, "A whistling composition burns intermittently. Every time

the surface is ignited, a wave passes down the tube and is reflected as a wave of rarefaction from the open end. This wave of rarefaction strikes the surface of the composition where it is reflected without change of phase, i.e., as a wave of condensation, and travels down to the surface of the composition." He suggests, "that the mechanism of combustion . . . involves the explosion of crystals as an essential part of the process. If the composition is not contained in a suitable tube, these crystals will explode in random fashion and the products of combustion will flow from the surface at a uniform rate and no definite note or indeed any sound of appreciable intensity will result. If, however, the composition is contained in a suitable resonating tube, the flame will be forced in and out of the surface by alternate waves of compression and rarefaction and every time it is forced into the surface a fresh mass of crystals will explode."

Maxwell's hypothesis was tested by an addition of 3% metal powder (Cu or Fe) to the perchlorate-benzoate mixt to enable the flame front to travel more quickly. The metal additions produced shriller, ie, higher frequency whistles, supporting the hypothesis (Ref 3)

One problem with the whistle mixes investigated by Maxwell is their sensitivity to accidental or premature detonation. Ellern (Ref 2) gives the formula (No 160 of Table 1) for the reputedly

safer US mixt: K perchlorate 72.5—Na salicylate 27.5%. However, McLain (Ref 3) knows of two high-order explns definitely caused by the salicylate whistle mixt. Probably, high order explns are an inherent risk with all whistle mixts. The physiological hazards associated with the picrate mixt, however, may outweigh the expln hazard. Not only does it cause long-lasting skin discoloration, but its dust is extremely irritating (Ref 3)

Refs: 1) W.R. Maxwell, "Pyrotechnic Whistles", 4th Combstn Symp, Paper No 111, The Williams & Wilkins Co, Baltimore (1953), 906 2) H. Ellern, "Military and Civilian Pyrotechnics", Chemical Publishing Co, NY (1968), 181-84 & 376-77 3) J.H. McLain, "Pyrotechnics", The Franklin Institute Press, Philadelphia (1980), 123-27

White Compound. See under "TNT" article in Vol 9 in the following sections: "Preparation", T241-L; "Purification", T244, Table 1: "Chemical Reactions and Derivatives", T248-R; and in Vol 8, N84-R

White German Powder. See in Vol 1, A507-L under "Augendre Powder"
Addnl Ref: VanGelder & Schlatter (1927), 782

R. Whitehead (1823-1905). Inventor of the torpedo. In 1866, he designed at Fiume, Italy, a torpedo capable of running 700 yards at 7 knots. To this he added several improvements, including a "servo-motor" attached to the steering-gear. By 1889 the range had been extended to 1000 yards at 29 knots, but satisfactory accuracy of direction was not achieved until seven years later, when a gyroscope was introduced, together with vertical rudders which acted on the servo-motor so as to correct the steering. During the last thirty years of the century rights of construction were purchased by the governments of Austria-Hungary and the principal naval powers. The efficiency of the Whitehead torpedo in action was shown by the Japanese in their attack upon the Russian fleet off Port Arthur in Feb 1904

Ref: T.I. Williams, Ed, "A Biographical Dic-

tionary of Scientists", 2nd Ed, John Wiley & Sons, NY (1974), 555

White Phosphorus. See in Vol 8, P253-L to P255-L

White Powder. A compn for filling Hydrox-type devices (see Vol 7, H228-R to H229-L) consisting of AN, 1 to 10% chromate compds (Amm or K chromate and dichromate), plus carbonaceous materials

Refs: 1) T. White, BritP 449193 (1936)
2) Cook (1971), 15-16

Wiener Powders (Baked Powders). Introduced in Russ in 1873, they were prepd by compression of the usual ingredients of BlkPdr, preheated to 120°. This was done in order to melt the sulfur, and thus achieve its better distribution thruout the mass

A similar powder was manufd later in the USA and was known as *Russian Powder*. In Engl, a similar powder was known as *Baked Powder*. Tests conducted in 1878 at Woolwich Arsenal indicated that this powder was no better than conventional BlkPdr. The same unfavorable results were obtained by a Colonel deMaria in Italy

Refs: 1) Daniel (1902), 808 2) B.T. Fedoroff et al, "Dictionary of Russian Ammunition and Weapons", PATR 2145 (1955), 26

Wigfall Powder (Prussian Fire, Feu Prussien in Fr). Accdg to BritP 2888 of 1863 this expl contains K chlorate, K nitrate, nitric acid, phosphorus, sulfur, sugar, red lead and steel turnings. Daniel (Ref 1) doubts if such a dangerous expl was ever prepd

Refs: 1) Daniel (1902), 809 2) Giua, Trattato 6 (1959), 391

Wilhelm Explosives. Patented (No 9952) in Ger in 1894 expl mixts consisting of inorganic nitrates or oxalates with small amts of chlorhydrates or organic salts of aromatic amines. Typical formulations were: 1) Amm nitrate 92,

aniline acetate 8; 2) Amm nitrate 90, aniline chlorhydrate or tartrate 10; and 3) K oxalate 94, naphthalene oxalate 6%. These were manufd by Dynamit Aktiengesellschaft, vormal's Alfred Nobel, at Hamburg
 Ref: Daniel (1902), 809

Wilhelmit. Ger Cheddite-type blasting expl introduced during WWI. It consists of Na or K chlorate mixed with a hydrocarbon oil with a flash pt not below 30°, and carbohydrates
 Ref: Marshall, Dict (1920), 103

William Powder. Expl formulation contg K chlorate 57.15, KCN 19.05, starch 7.14, crude mineral oil 5.95, gall nuts 5.95, K dichromate 2.38 and charcoal 2.38%
 Refs: 1) Cundill (1889) in MP 6, 118 (1893)
 2) Daniel (1902), 810

Will's Stability Test. E. Will developed a stability test in 1900 which consists of determining the volume of N₂ evolved from NC when kept at 135°, gaseous products being removed by a stream of CO₂. The nitrogen oxides evolved during decompn are reduced by hot Cu, and CO₂ is absorbed by a concd soln of K hydroxide. The volume of N₂ is recorded every 15 minutes, and the test lasts for 4 hours

The method was very useful for research but was difficult to apply as an everyday control of stability (Ref 3). Besides, the fact that nitrogen oxides are removed from the sample by the stream of CO₂ creates conditions which differ from those existing during storage of NC or smokeless powder, when all the decompn products remain in contact with the parent substance
 Refs: 1) Barnett (1919), 225 2) Reilly (1938), 86-87 3) Urbanski 2 (1965), 26

Winchester. US small arms manufacturer. Oliver Winchester (1810-1880) was a prosperous shirt-maker who had some capital invested in the Volcanic Arms Co in 1855. The company made a lever-action rifle which used an odd self-contained cartridge which was simply an elongated bullet with the propelling charge in

the hollowed-out base. Due to the poor ballistic shape and small charge it was neither powerful nor accurate and the rifle failed to sell; in 1857 the company collapsed. Winchester, however, was convinced of the utility of a repeating rifle, and for just over \$39000 he purchased the assets and stock, and set up as the New Haven Arms Co. Having no mechanical ability, he then hired Tyler Henry, a brilliant gunsmith and engineer, to redesign the rifle. Henry first developed a 0.44-inch (11.2mm) rimfire cartridge and then rebuilt the rifle. Every rimfire cartridge made since then by Winchester has been marked "H" on its base. The rifle used basically the same lever beneath the stock to actuate a toggle lock and withdraw the bolt as had the earlier Volcanic, and it also used the same tubular magazine beneath the barrel, feeding a fresh round to the breech with every stroke of the lever. Henry's contribution was to make it more robust and reliable

The start of The American Civil War would appear to have given Winchester and the Henry rifle a golden opportunity, but in fact the Union Army was not disposed to such complicated devices as repeating rifles and bought very few. On the other hand, sales to State Militia units and to homesteaders in isolated areas were sufficient to carry the company thru the war. In the years after the Civil War, many companies who had prospered from the conflict were unable to make the transition to peacetime and collapsed. Winchester, however, was astute enough to promote his rifle overseas to such countries as Peru, France and particularly, Turkey. The latter bought rifles and ammo to the tune of \$1.46 millions

In 1866 the company had been reformed as the Winchester Repeating Arms Co and the product became the Winchester Rifle. It was still Henry's design, but with an addition whereby the magazine was loaded thru a port in the receiver instead of from the front end of the magazine tube. Essentially, the Winchester design had arrived at its definitive form, and although the company has made innumerable lever-action models since then, and continues to produce them, they are only superficially changed from the 1866 pattern. The most significant change came with the Model 1873, which introduced center-fire ammo to the Winchester range

Although Oliver Winchester had always sought to promote his rifle as a military weapon he had little success in that direction, and it became primarily a commercial success. Lever-action rifles are, to say the least, inconvenient when fired from a prone position, and once the military bolt-action had been perfected in magazine form, military use of lever-action rifles almost entirely ceased. The only major adoption of lever-actions after the 1870s was when Winchester sold 293818 of their model 1895 rifles to Russia in 1915–17, together with 174 million cartridges, but this can be largely ascribed to the general shortage of rifles at that time

In an attempt to enter the bolt-action military field, the Winchester-Hotchkiss was developed in 1883. This had been designed by Benjamin B. Hotchkiss (of Hotchkiss machine-gun fame) and Winchester bought the manufg rights. It was a bolt-action repeater with tubular magazine in the butt, chambered for the .45-70-405 US government cartridge. The US Army bought 750 of these for extended trial but eventually decided that the time was not yet ripe for adoption of a magazine rifle. With that, Winchester more or less gave up hope for the army and concentrated on commercial work

The next military venture came with the making, for the US Navy, of the Lee straight-pull bolt-action rifle. The US Navy had agreed to adopt the rifle, but Lee had no facilities for manufg in quantity. Winchester therefore bought rights to manuf, and, as a bonus, tried to push it on the commercial market. The navy's order amounted to 15000 and once that was completed the rifle was advertised as a sporting weapon. But its small caliber and unusual bolt told against it in the hunting market of the time, and no more than about 1700 were sold commercially

WWI saw a vast increase in military orders, among the first of which was a Brit contract to produce the Enfield P'14 rifle. After some 253000 had been made, and the US had entered the war, production was turned over to the P'17 model in .30-06 cal for the US Army and another 550000 were made. In addition, the Browning automatic rifle was made, and some 100 million rounds of .303 ammo supplied to Britain. The company's commercial shotguns were also pro-

vided with bayonets and supplied as trench-warfare weapons, and 525 million .30-06 cartridges were turned out for the US forces

In WWII production concentrated on the M1 rifle (513582 made) and the Winchester-designed M1 and M2 carbines, almost a million of both these types being made. In the early years of the war the company developed their Model 30 rifle, a semiautomatic intended to compete with the M1 Garand. This used an action similar to that of the carbine and had a detachable box magazine. The US Army was, understandably, against the idea of having two rifles in service and, being satisfied with the Garand, rejected the Model 30. It was tested by a Brit representative in Sept 1940, who reported that with slight modifications it was suitable for adoption by the Brit service. At that time, though, the Brit were no more keen on changing horses in mid-stream than was the US, and the suggestion came to nothing

Since 1945 the company's principal military production has been of some 356500 M14 rifles for the US Army in 1960–63

Ref: B. Fitzsimons, Ed, "The Illustrated Encyclopedia of 20th Century Weapons and Warfare", Purnell Reference Books, Milwaukee (1979), 2598–99

Wind Gun. See in Vol 6, G190-L

Windshield. A cap of light metal placed over the point or head of a projectile to increase its efficiency by streamlining it. For more details, see in Vol 1, A483-L & R under "Armor-Piercing (AP) Projectile"; in Vol 2, B5-R under "Ballistic Cap"; and in Vol 4, D820–21 (Figs 1-7, 1-8 & 1-9)

Ref: Anon, "Dictionary of United States Army Terms", AR 310-25 (1977)

Windsor Powder. Patented in Engl (BritP 3510, 4 Dec 1871), it contained 100p of BlkPdr and 25p of sugar

Ref: Daniel (1902), 810

Winiwarter. Patented in Engl (BritP 13935, 29 Jan 1852; BritP 306, 4 Feb 1853) primary expls contg a soln of collodion cotton (pyroxylin) mixed with the following ingredients:

Mixt No 1: MF, K chlorate, Sb sulfide, charcoal, K nitrate & K ferrocyanide

Mixt No 2: Zn fulminate, K chlorate, Sb sulfide, Pb dioxide & K ferrocyanide

Mixt No 3: Amorph P, Pb dioxide, charcoal & K nitrate

Refs: 1) Cundill (1889) in MP 6, 118 (1893)
2) Daniel (1902), 810

Winter Explosive. A mixt of pulverized K chlorate 87, sawdust 3 and petroleum oil 10%
Ref: Pepin Lehalleur (1935), 350

Wire-Wound Gun. A built-up gun in which one layer of the assembly is formed of wire strip, tightly wound. The advantages are that the whole of the wire can be tested for strength, which is impossible with a forged tube. By winding with various tensions, the tension on the gun can be adjusted layer by layer. Wire has twice the tensile strength of forgings, and should the wire fail in service, the effect is local, and it is not likely to split along the length of the gun, as would a tube. The drawback is that wire gives no longitudinal strength to the gun, and it is necessary to enclose it in a full-length jacket. Even with this, wire-wound guns show a distinct tendency to droop at the muzzle. About 185 miles of wire were used in winding the Brit 15-inch gun, and this was wrapped in 79 layers at the breech end, tapering to 20 layers at the muzzle

Ref: I.V. Hogg, "British and American Artillery of World War 2", Hippocrene Books, Inc, NY (1978), 256

Withnell Powder. An older Brit coal mining expl of the Grisounite type contg Amm nitrate 88–92, TNT 4–6, dried flour 4–6 and moisture 0–1.5%. It was made by the Lancashire Explosives Co, and was on the old Permitted List
Refs: 1) Marshall, Dict (1920), 103 2) Colver (1938), 250

Witness Plates (Plate Denting Tests). See under "Plate Denting Tests" in Vol 1, XIX & XX, under "Brisance" in Vol 2, B266 to B295 (Table 1), and the following *Addnl Refs:* 1) Anon, Engrg Design Hndbk, "Explosives Series, Explosive Trains", AMCP 706-179 (1974), 12–19 [The following material describes Steel Dent and Aluminum Dent Tests for detonators: "The *steel dent test* consists of firing a detonator in direct end-on contact with a steel block in accordance with Test 301.1 of MIL-STD-331A (Military Standard—Fuze and Fuze Components, Environmental and Performance Tests for; 15 Oct 1976). The depth of dent, determined by a dial indicator, is a measure of output. Explosive components may be either unconfined or confined in polystyrene, brass, aluminum, or steel. The depth of dent correlates well with initiating effectiveness. It has been shown that the depth of dent is proportional to the excess of pressure over the yield strength of the steel of the dent block, integrated over the volume of the detonation head. It has been found that a detonator of 0.190" diameter or larger, which produces a dent 0.010" deep in a mild steel block, will initiate a lead of Tetryl or RDX under favorable conditions. Specification dent requirements for detonators to be used in fuzes are usually at least 0.015" to 0.020" deep, and many produce dents up to 0.060" deep. Dent tests are also used to measure the output of leads and boosters, and to determine whether token main charges have been caused to detonate high order. Plates used for this purpose are sometimes referred to as *witness plates*.

The output test using an aluminum block is performed in accordance with Test 303 of MIL-STD-331A. This test is identical in all respects with the steel dent test except that dent block is made of aluminum. Substitution of the softer metal allows testing of components whose output is insufficient to dent steel."]
2) C.L. Mader, "Numerical Modeling of Detonations", Univ of California Press, Berkeley (1979), 293–97 ["The most useful and simplest experiment that can be performed to obtain a good estimate of the detonation C-J pressure is the plate dent test described by Smith (L.C. Smith, Explosivst No 5, 106 (1967)) and performed by M. Urizar for over 30 years at Los Alamos. Of the usual experiments used to study detonation

performance, this experiment is also one of the most difficult to simulate numerically. The usual Lagrangian codes cannot describe the highly distorted flow around the surface of the dent, and the usual Eulerian codes do not include realistic enough treatments of the material properties. The recent addition of elastic-plastic flow to the Eulerian code 2DE has permitted us to examine the plate dent problem theoretically.

The plate dent test merely involves detonating a cylindrical charge of explosive in contact with a heavy steel plate and measuring the depth of the dent produced in the plate. The charges used are of a diameter and length sufficient to ensure establishment of a steady detonation wave of almost infinite-diameter velocity. The witness plates are massive and strong enough to limit the damage to the dent area so that the depth of the dent does not depend on any gross distortions of the entire plate. Several test plates are stacked up on the ground, and the upper surface of the top plate is lightly greased. The explosive test charge is centered on the plate with a large enough booster to initiate the test charge and a detonator. After the shot has been fired, the test plate is recovered and the depth of the dent is measured by placing a ball bearing in the dent (and measuring from plate surface to top of ball bearing) to eliminate the effects of irregularities in the dent.

The plate dent experiment would be just another integral experiment except that the depth of the dent has been observed to correlate linearly with experimentally determined C-J pressures of large charges of explosives that exhibit "ideal" behavior. Another interesting observation is the scaling of the dent with charge radius."]

Wohanka. Patented in Engl in 1887 (BritP 7608) a series of expl compns prepd by stirring cellulose together with aromatic nitrocompds dissolved in concd nitric acid. The cellulose undergoes nitration during the addition, and the resulting NC dissolves in the aromatic nitrocompd, forming a jelly

Ref: Daniel (1902), 810

Wohl. Patented in Ger in 1890-91 (GerP 7036) a method for the prepn of low-freezing NG, contg some nitropolyglycerin. In this method, glycerin was heated at 130° with concd sulfuric acid, then cooled and nitrated to NG. When still lower freezing NG was required, a small quantity of alcohol was added to the glycerin. On heating in the presence of concd sulfuric acid, some ethyl ether of glycerin was found

Ref: Daniel (1902), 811

Wolf. Israeli battlefield rocket. During the 1973 Middle East conflict the Israeli Army is reported to have used large numbers of short range Ze'ev (Wolf) rockets. Two versions are believed to have been used, one with a range of 1000m (100 yds) and fitted with a warhead weighing 170kg (375 lbs), and another with a range of 4500m (4900 yds) carrying a warhead weighing 70kg (154 lbs). The rockets are said to have been launched from a portable frame type launcher, had calibers in the range 150-200mm (5.9-7.8"), and were used mainly against troop and vehicle concentrations

In the past most weapons developed in Israel have been offered for export, but these weapons appear not to have been. No photographs have been released, and it may well be that they have been phased out of service. In recent years the Israeli Army has adopted the Soviet 240mm (12-round) BM-24 MRS, and rockets for this system are now being manufd in Israel by Israel Military Industries

Refs: 1) C.F. Foss, Ed, "Jane's Armour and Artillery, 1979-80", 1st Ed, Franklin Watts, NY (1979), 515 2) B. Fitzsimons, Ed, "The Illustrated Encyclopedia of 20th Century Weapons and Warfare", Vol 24, Purnell Reference Books, Milwaukee (1979), 2615 (under "Ze'ev") 3) R.T. Pretty, Ed, "Jane's Weapon Systems, 1979-80", 10th Ed, Franklin Watts, NY (1979), 412

Woodbury Explosives. C.A. Woodbury was issued four US patents for expl formulations from 1915 to 1919: 1) Expls having a relatively low deton vel consist of granulated Amm nitrate (grain size approx 0.1" in diam), NG and absorbent material such as woodpulp (Ref 1).

2) Low freezing pt Dynamites contg nitrated sugar, eg, nitrated sugar 4, NG 30, TNT 10, Na nitrate 42, woodmeal 13 and chalk 1% (Ref 2). 3) Expls suitable for use as bursting charges in shells, grenades, mines and torpedoes may be composed of TNT 20, PA 20, and Amm picrate 60%, or TNT/PA/Amm picrate in equal proportions, or TNT/PA/Amm picrate in 25/50/25 proportions, or TNT/PA/Amm picrate in 50/25/25 proportions (Ref 3). 4) Bursting charges for projectiles consist of TNT and PA, or TNT, PA and TNX (Ref 4)
 Refs: 1) C.A. Woodbury, USP 1124679 (1915) & CA 9, 717 (1915) 2) Ibid, USP 1149487 (1915) & CA 9, 2710 (1915) 3) Ibid, USP 1309558 (1919) & CA 13, 2281 (1919) 4) Ibid, USP 1312464 (1919) & CA 13, 2598 (1919)

Wood Gum. See under "Gum" in Vol 6, G186-L to G187-R

Woodnite. A Dynamite, patented in Fr by Chabert in 1888, consisted of NG absorbed by either wood pulp or nitrated woodpulp
 Ref: Daniel (1902), 811

Woolwich Testing Gallery. See in Vol 3, C372-L under "Coal Mining Explosives, Testing for Permissibility"

WOUND BALLISTICS

Wound ballistics is the study of the effects of projectiles in the human body. It is therefore basic to the understanding of the wounding effects of both bullets and fragments,, which between them cause over 90% of combat casualties in conventional warfare (Ref 1)

As a precursor to this discussion, the definition of certain terms used becomes obligatory:

Ballistic Shape. For small arms ammo, three general bullet shapes apply. Bullets with round noses (which, except for pistol or sub-machine gun ammo, are virtually obsolete), bullets with pointed noses and flat bases, and bullets with pointed noses and streamlined or boat-tailed

bases. The two classes of pointed bullet represent the norm of conventional rifle calibers. Apart from these three general bullet shapes, new developments in ammo have led to bullets with asymmetrical ogives, and to flechettes or similar projectiles

Spin. The bullet spin is induced by the rifling of the weapon, and is the rotation of the bullet about its axis. At the commencement of flight, the rate of spin is very great-around 200000rpm for a 7.62mm NATO rifle bullet. This spin will prevent a conventional bullet (but not a sphere) from tumbling along the line of flight. It also tends to maintain the axis of the bullet during flight paralld to the axis of the bore of the weapon firing it, and not parallel to the ground

Yaw. Yaw is the deviation of the longitudinal axis of the bullet from the line of flight. It will vary significantly in degree at various points along the trajectory, and will continue, still in varying degree, when the bullet enters the denser medium represented by the tissue of a body. Yaw commences soon after the bullet leaves the barrel since, passing through the barrel, the center of gravity of the bullet is forced to travel in a circle and is not on the axis of the bore, whereas, upon leaving the bore, the rotation centers on the center of gravity. Inherent or induced asymmetry in a bullet is an important factor in the production of yaw, and this in turn materially affects the wounding characteristics of the bullet

Center of Gravity. In a conventionally shaped bullet, this tends to be towards the rear. Since under normal condition of mass production total accuracy is impossible, the center of gravity is usually not on the axis of symmetry of the bullet

Center of Pressure. In a conventionally shaped bullet forces tending to retard the bullet in flight are focussed on a point along the axis of the bullet towards the nose. This point is the center of pressure

Overtum Couple or Lever Arm. The distance between the center of gravity and the center of pressure is known as the overturning couple or the lever arm, and thru this the stabilizing forces deriving from spin operate. Since neither of these two centers lies exactly on the axis (due to normal manufg errors) the result is yaw. The

greater the distance between the two centers, the more stable the bullet tends to be, and therefore a longer bullet tends to be more stable than a short one

The Bullet in Flight

Upon leaving the muzzle, spin imparted by the barrel rifling prevents the bullet tumbling base over tip, and it also preserves the bullet's axis parallel to the line of the bore. Yaw at the muzzle, in a properly made bullet, will only be a maximum of 2 or 3 degrees, and may be as little as a few minutes of angle. Yaw however does not remain a constant figure during flight, and will increase, typically reaching its maximum at about 5 meters (about 15') from the muzzle, at which point spin reasserts itself, and yaw diminishes. Thereafter there is a cycle of increasing and diminishing yaw thruout the range of engagement, and at longer ranges this becomes more potent as the effect of spin diminishes. At longer ranges, as yaw becomes more potent, and as the spin has kept the axis of the bullet in line with the line of the bore, the bullet tends to approach the target, assuming the target to be in the vertical plane, otherwise than at right angles. This in itself influences the effectiveness of the bullet, but the resultant asymmetry of the atmospheric retardation also has the effect of further increasing the degree of yaw

Impact with the Human Target

The bullet entering tissue produces a permanent track or tunnel, the missile leaving cut and torn tissue in its wake. While cutting thru the tissue, the bullet also imparts shock waves and radial velocity to these tissues, which absorb energy given up by the bullet. The pressure developed with these shock waves can be of the order of about 70kg/cm² (1000 lbs/inch²). In absorbing the energy some tissues, more elastic than others, react so that they move outwards and create a large temporary cavity. This cavity, in the space of a few msecs, goes thru several pulsations, expanding and retracting, before reverting to a semi-permanent shape. All this takes place before the victim, if he still lives, can comprehend the detail of what is occurring

The shape of the permanent path may not always be obvious from the mere examination of the entry and exit holes of the bullet. Depending

upon the part of the body struck, and the proximity of more solid obstacles such as bone, and the degree of yaw, etc, the bullet may or may not create a simple "tunnel" wound, of permanent diameter only slightly less than that of the bullet itself. Quite possibly however the bullet, after entry, may cause a large permanent cavity within the limb or body, and this in turn may be accompanied by a large exit hole (if the bullet exits at all) or by a deceptively small exit hole. The existence of large permanent cavities, accompanied by gaping exit (or entry) holes has often, in the past, led to accusations, entirely false in fact and based upon faulty ballistic knowledge, that the enemy at the time was using expl or expanding bullets

As has been stated, a bullet develops yaw along its path thru the air, this yaw reappearing at intervals along the trajectory. The bullet will continue to yaw, if it is yawing already, when it hits the target. Alternatively, it can commence its cyclic yaw after entry. The effect of the denser medium of the human tissue will accentuate the angle of the yaw, and trials have shown that a bullet having very slight yaw at impact may develop yaw within the target of anything up to 50 or even 100 degrees. This therefore plays a large part in creating a permanent cavity of far greater size than the diameter of a simple tunnel wound, with dire consequences to the victim. It is often the case that spin reasserts itself when the bullet is still within the body, reducing yaw, so that the bullet makes a small clean exit hole. Often the reverse is true. Yaw will further change as obstructions of varying density are met, such as bone. Since yaw effect is greater in tissue or bone than in air, yaw augments retardation of the missile, and therefore helps the kinetic energy to be given up in the wound, all of which increases wound efficiency

Apart from the permanent cavity (which, in spite of its name, and assuming the victim lives and is medically tended, will largely heal up) mention has been made of the temporary cavity. The shape of this temporary cavity is, except where yaw has taken effect, in the form of an ellipse. Its volume may be as much as 26 times the volume of the permanent cavity at its widest point. Surrounding the temporary cavity is an area in which the tissue is to a greater or lesser

extend damaged. This tissue will, if kept clean, tend to revitalize itself. If not kept clean, and under battlefield conditions cleanliness may be difficult or impossible, the damaged tissue becomes a breeding ground for bacteria, and this in turn is responsible for such things as gas gangrene, and relatively simple casualties may then become more seriously stricken, or die. The temporary cavity vanishes quickly (in msec), leaving only an area of damaged tissue surrounding the permanent track

Apart from causing the cavities referred to, high-velocity bullets with the shock waves which accompany them, can cause secondary damage to bones, etc, not directly in the path of the bullet. Simple fractures therefore may be caused to bones without direct impact having taken place, and the same can happen to blood vessels not directly struck

Shock waves, in tissue, arise at the point of impact. In tissue the velocity of these shock waves is about 1462m/sec (4800 ft/sec). Shock can incapacitate and, in extreme cases, can kill

The slowing down or retardation of a bullet as it traverses tissue is an important factor in determining how that missile delivers up its energy to the tissue, and how effective therefore it is as a wounding and shocking force. A missile of large presentation area and small mass gives up its energy rapidly, and will produce a wide but short temporary cavity. This is a factor in the wound efficiency of the flechette type of projectile

The Human Target

A man, standing erect, has a total target area which may be calculated in different ways, but an area of approximately 4.5 ft² is generally accepted. In general the rear of a man offers better "built-in" protection to the vital organs, by means of tissue, bones and so on, the front being more vulnerable. Of the total area, the vulnerable portion has been calculated as 40%, the vulnerable areas being organs, canals, nerve centers, major blood vessels, etc. The probability that a bullet will pierce thru to the vulnerable area increases with the bullet's energy and velocity

Target analyses in WWII and Korea, supported by US experience in Viet-Nam, shows that the three sub-divisions of the vulnerable

area (head, chest and abdomen) account for 40% of hits, and the extremities (legs, arms, hands, feet, etc) account for the balance. The victims in this analysis were unprotected by body armor, the advent of which has radically changed the pattern, since casualties now incurred show a preponderance of head and possibly lower abdomen wounds (depending on the type of armor) and extremities, since hits on chest and upper abdomen, while still occurring, are largely ineffective. In any case, it must be stated that the above figures represent an analysis of hits inflicted by all weapons and not just small arms, and except in certain types of campaign, or in certain types of engagement, gunshot wounds account for, at best, under 30% of the total hits, and in some areas have been as little as 10%. However, much of the survey work was upon casualties suffered by "friendly" troops, and here, particularly in Korea and Vietnam, these forces had a superfluity of supporting arms and weapons, ranging from direct air support, including napalm, to heavy artillery, while the enemy had not, and a corresponding analysis of enemy casualties in these conflicts may have shown an even smaller percentage of wounds inflicted by small arms. As against that however, underdeveloped countries in the future will, if they are engaged in hostilities, probably not equip their infantry with body armor, and, since such countries may often be rich only in manpower, "human wave" attacks, such as sometimes occurred in Korea, could present a situation where the volume of wounds caused by defending small arms rose to high levels

From the point of view of the defensive battle, the object of small arms fire is currently often expressed in terms of incapacitation, such that the enemy soldier will receive a wound that renders him incapable, within 30 seconds, of continuing the assault

The range at which the human target is engaged depends upon the tactical situation. On the one hand, enemy infantry forced to dismount from their armored personnel carrier at extreme range, perhaps 1000 meters, present a target totally different from that presented by either the urban guerrilla or an enemy soldier who falls into an ambush on a jungle trail at a range of 30 meters. Effective maximum infantry ranges of about 300 meters are now generally

accepted as the standard, both to identify the enemy as hostile and to engage him with effective fire from platoon weapons. A moving infantry man, at 300 meters, may not easily be effectively hit by the average rifleman, and even if he is, 60% of the hits are likely to be extremity hits only, and may not stop the assault. Current weapon and ammo development is intended to improve this effective hit ratio

Ammunition Design and Wound Effectiveness

The Hague Convention of 1899 ruled illegal bullets which have jackets with slits or an opening at the point which would permit the jacket to strip upon impact with the target, allowing the lead core to mushroom, causing very serious entrance wounds. The intention of the Convention was clear, and the elimination of "dumdum" type wounds was an admirable idea, except that the fundamental ballistic thinking behind the remedy put forward by the Convention lacked a full appreciation of all the factors involved, and was based more on supposition and random observation than upon scientific study. This is hardly surprising since wound ballistics as a science had not begun to develop. It was not then appreciated that yaw played the part it did in causing cavity wounds, neither was it realized that "conventional" looking small arms bullets, having full metal jackets could, by their internal structure, cause large complicated wounds similar to those caused by open-nosed bullets. Even less probably did the convention recognize the importance of velocity in the wound effect equation

Two bullets may be cited as possessing, under certain circumstances, peculiar wounding characteristics. The first, and unintentionally severe, bullet was the Brit .303" Ball Mark 7. In this design, in order to place the center of gravity as far to the rear as possible, the nose filling consisted of a small Al plug. This plug, under wartime conditions during WWI when Al needed to be conserved, was replaced by wood, china, wire, etc, the basic Pb/Sb core being unchanged. The nose of the Mark 7, irrespective of the type of nose filling chosen, tended to break off and could cause, in a wound, break-up of the bullet with consequent serious wounding effect. The intention behind this design however had been no more than to improve the external ballistics

of the bullet, by placing the center of gravity far back

The second example was the 6.5mm Jap rifle round, where, probably intentionally from the wounding point of view, the Pb core was thickened considerably at the base compared to the upper portion. This bullet, in spite of its small caliber and lowish velocity, tumbled badly upon hitting tissue, and caused serious wounds

In recent years, bullet design has been concerned not only with exterior ballistics and accuracy, but wound effect. Designers, for the first time, have had at their disposal the benefit of specific research into wound ballistics. Some of the solutions offered are shown below, often in conjunction with the weapon solutions already referred to

High Velocity, Small Caliber Bullets

Here the solution, embodied in such cartridges as the US M193 cartridge in 5.56mm x 45 caliber, centers upon high velocity, and high residual kinetic energy. The small 3.5g (55 grain) bullet is conventional in shape, Pb-cored, and with pointed nose and boat-tailed rear. Initial velocity is 1005m/sec with a muzzle energy of 184mkp. At 400 meters range, velocity has fallen to about 518m/sec and striking energy is down to about 55mkp. It is an accepted "wound ballistic yardstick" that, to cause a casualty, a bullet needs to deliver up to the target, at the moment of impact, about 8mkp of energy. The 5.56mm bullet, at this range, is thus an effective solution. Experience in the past few years has shown that the M193 bullet, at high impact velocities (at short range) can break up in the wound and, apart from any other results, causes a very large wound

High Velocity, High Sectional Density Bullets

These bullets, usually of caliber smaller than 5.56mm, are being developed currently in a number of Western countries. Ballistics at the muzzle for this class tend to follow fairly closely those of the 5.56mm, but the bullets have a greater length in relation to their diameter (ie, they are long and thin). These projectiles should be stable in flight, because of the length of the "overturning couple" but are intended, upon impact, to tumble quickly and give up their energy. The advantage in this class of bullet,

compared to the M193, is likely to be in the exterior ballistics area

Flechette

Flechettes are in fact an extension of the high sectional density theory, coupled with fins for stability in flight (most flechette weapons are smoothbore) and a non-composite body construction. The short range, ultra-high velocity flechette (velocity approx 1372m/sec) performs well as a wounding agent at short range. The long dart, not unlike a simple nail in construction, deforms easily and quickly upon impact, and gives up its residual energy in a very satisfactory manner. At 400 meters a typical single flechette will have a residual velocity of about 1036m/sec and a striking energy of about 26mkp, well above the "norm" of 8mkp

Heckler and Koch Spoon-Point

In West Ger, Heckler and Koch have recently developed a new small caliber bullet with *Löffel-spitz* (spoon-point). Here the ogive of the bullet is asymmetrical, and into one side is scooped out a depression, similar to the imprint left by the base of a spoon. This design is intended to cause the bullet to incline as soon after impact as possible, and so give up its energy as efficiently as possible. Heckler and Koch claim that the spoon point does not cause the bullet to tumble, but merely accentuates the tumble and causes it to occur as close to, or on, the surface as possible. This design is specifically to increase the incapacitating effect of wounds caused in legs and arms, where otherwise the bullet may have made its exit without yawing. These bullets are made with both Pb and W cores, and do not lose accuracy because of the ogive, or at least do not lose it to any significant degree

Conclusion

Short of actual war, the theory of wound ballistic development is often difficult to prove completely, since only in war can the full effect of new designs be seen on the casualties caused. Most of the proof of designs so far considered (with the exception of the 5.56mm M193) has been carried out with artificial media, or sometimes with dead or drugged animals. Neither artificial media, nor animals can completely re-

produce the effect upon human targets. Human targets in any case vary in size, weight and durability, and it is doubtful if completely typical conditions can ever be determined. Bullet design will continue to improve, in terms of lethality, but there must be serious doubts that total hit ratios will or can significantly improve, or that the hit efficiency ratio will also change greatly, especially if body armor becomes accepted on a world-wide basis (Ref 2)

Refs: 1) Anon, "Projectile Wounds and Wound Ballistics" in "Anti-Personnel Weapons", Stockholm International Peace Research Institute, Crane, Russak & Co, NY (1978), 53-76
2) J. Weeks, Ed, "Jane's Infantry Weapons, 1979-1980", 5th Ed, Franklin Watts, NY (1979), 320-22

WP (Würfelpulver). Ger flaked smokeless propnt in the form of small rectangular grains. It was first manufd under the acronym *WPC/89* (Würfelpulver Construction 1889) by the Vereinigte Köln-Rottweiler Pulverfabrik in Rottweil, Württemberg for use in 37, 53 and 150mm cal Army guns. Barnett (Ref 2) gives the following compn for an early WP: NG 50, NC 50% and a small quantity of added diphenylamine. Brunswig (Ref 3) gives NG 38.5, NC 60, centralite or acardite 1.0 and moisture 0.5% as the formulation of a post-WWI WP

Refs: 1) Daniel (1902), 811 2) Barnett (1919), 78 3) Brunswig (1926), 136

W (Poudres). Older Belg BlkPdr manufd at Wetteren, used in 100 to 340mm cannon
Ref: Daniel (1902), 799

W (Pulver). Older Austrian BlkPdr, used in 150 to 280mm cannon. The grain sizes were 31/38mm and 45/54mm, respectively
Ref: Daniel (1902), 799

WRX. Code designation for "H-16". See in Vol 7, H1-R and Vol 5, D1118-R

W-Salz. Ger for Cyclonite or RDX. See in Vol 7, H93-L

X

X-4, Ruhrstahl. Ger WWII air-to-air missile. Development of the X-4 was begun as a private venture by Ruhrstahl AG Presswerke, Dr Max Kramer leading the design team. The missile was intended to arm Fw 190 and (later) Me 262 fighters deployed to intercept unescorted bombers. The launch aircraft was too vulnerable for an attack to be pressed home against fighter opposition, since the pilot had to guide his missile all the way to impact. Ruhrstahl received an official development contract in the summer of 1943; the first rounds were ready by the following April, and the initial airborne launching took place from an Fw 190 over Gütersloh on 11 Aug 1944. Some 255 pre-production X-4s were built for testing, but on 6 Feb 1945, an air raid on the BMW factory at Stargard destroyed the motors for all 1300 missiles being constructed by Ruhrstahl. Neither the resources nor the time was available to set up a new production line, so the project was allowed to lapse

X-4 was a cigar-shaped weapon with 4 comparatively large swept wings and 4 fins. The missile was launched from standard underwing bomb racks, each aircraft being able to carry 4 rounds. The pilot would select a missile, run up its stabilizing gyro, aim at the target with his PKS-12 reflector gunsight and then press a firing button which uncaged the gyro, started the rocket motor, initiated the fuze-arming process, ignited the pyrot tracers and released the round

The X-4 was powered by a BMW 109-448 liq-proplnt rocket motor burning *Tonka 250* fuel (a 1/1 mixt of xylydine and triethylamine) oxidized by nitric acid, with hypergolic (contact) ignition. The initial thrust of 140kg (308 lb) gradually decreased to 30kg (66 lb) during the 17 second burn. The missile was spun at 60rpm by its canted fins and the effect of wing tabs, which stabilized it during flight. The launch-aircraft pilot steered the weapon by a joystick adjacent to his sight, his instructions being carried by steel wires to operate spoilers on the tail fins to steer the round in both pitch and yaw. The warhead, contg 20kg (44 lb) of dinitroglycol-based-expl, was detonated by a Kranich acoustic proximity fuze tuned to the 200-Hz frequency emitted by the engines of a US B-17 Fortress bomber and

effective at a range of 7m (23'). The missile length was 2m (6'7"), span 74cm (2'5"), weight 60 kg (132 lb), speed 800km/hr (550 mph) at 6400m (21000') altitude, and range 5.5km (3.4 miles) max length of wire

Ref: B. Fitzsimons, Ed, "The Illustrated Encyclopedia of 20th Century Weapons and Warfare", Vol 24, Purnell Reference Books, Milwaukee (1979), 2602-3

X-7, Ruhrstahl. Ger WWII antitank missile. X-7 was originally intended as a successor to the X-4 (see above) in the air-to-air role, using a two-stage, solid proplnt rocket in place of the BMW 109-448 and only a single spoiler for steering. The project was later taken over by the Ger army as an antitank weapon fitted with a hollow-charge warhead able to penetrate more than 200mm (7.9") of armor at an incidence angle of 30°. Its weight was 10kg (22 lb), speed 100m/sec (330'/sec), and range 1000m (1100 yds). X-7 did not become operational

Ref: B. Fitzsimons, Ed, "The Illustrated Encyclopedia of 20th Century Weapons and Warfare", Vol 24, Purnell Reference Books, Milwaukee (1979), 2603

Xactex. Trade name for nonpermitted blasting expl distributed by ICI Australia Ltd for use in Australasian area. It is a semigelatinous NG expl packed in small diameter cartridges (see below), and was developed primarily for perimeter blasting to promote smooth walls and to minimize overbreak. The small diameter cartridges in ordinary sized drill holes provide a poor coupling effect which results in a shearing action between adjacent perimeter holes, but has a mild effect on the unblasted rock outside the limits of the excavation. Details on Xactex are as follows:

Density g/cc	1.2
Weight strength, % BG*	84
Bulk strength, % BG	67
VOD**(unconfined), m/s	1900
Cartridge dimensions,	
diameter, mm	17
length, mm	500

footnotes

*BG = Blasting Gelatin

**VOD = Velocity of detonation

Refs: 1) C.E. Gregory, "Explosives for Australasian Engineers", 3rd Ed, Univ of Queensland Press, Australia (1977), 18, 20 & 103
2) Anon, "Technical Data - Explosives", ICI Australia Ltd (no date)

Xanthine. An old Blk Pdr substitute proposed by Prof Schwarr of Grätz, Austria. It contained K nitrate 68.5, charcoal 4.1 and K xanthogenate 27.4% (xanthate de potasse, $\text{KS}_2\text{COC}_2\text{H}_5$). The latter material was prep'd by adding an excess of K hydroxide and C disulfide to absolute alc

Ref: Daniel (1902), 812

Xanthylium Perchlorate (Xanthoxonium Perchlorate).

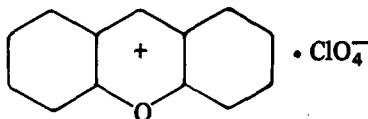

$\text{C}_{13}\text{H}_9\text{ClO}_5$; mw 280.67; OB to CO_2 -145.4%; lemon yellow crystals; mp 218-19°, 225-6°, 228° (separate values), 235° with decomn, explds on further heating (Ref 3). CA Registry No [2567-19-3]. Sol in tetrachlorethane

It was first prep'd by treating xanthidrol with perchloric acid in eth (Ref 3) or nitrobenzene (Ref 2). It has also been prep'd by the oxidation of xanthene with triphenyl methyl perchlorate, and the product recryst'd from acet to give bronze plates (Ref 6) The refs consider the comp'd to be an expl

Refs: 1) Beil 17, 129, (72), [146] & {1603}
2) M. Gomberg & L.H. Cone, Ann 376, 194 (1910) 3) K.A. Hofmann et al, Ber 43, 2630 (1910) 4) K. Ziegler, Ann 434, 61 (1923)
5) G. Conant & E. Garvey, JACS 49, 2084 (1927) 6) W. Bonthron & D.H. Reid, JCS 1959, 2778

X-Cord. Manuf'd by Explosive Technology, it is a metal-clad linear expl developed to sever materials, transmit an expl signal, or provide time delays in the microsecond range. Detonating velocities vary with the type of expl in the core

(RDX, PETN, HNS or DIPAM), with a minimum of 19685 ft/sec. Sometimes termed "mild detonating cord" in smaller diameters, it may be wrapped with a variety of plastics or textiles for partial or complete confinement of the detonation. The expl core is clad in a seamless, continuous metal sheath of Pb, Al or Ag. X-cord is also available in square, rectangular or cross sections other than round. The cord may be initiated with a standard blasting cap. Not commonly employed in commercial blasting, X-cord is used in aircraft, aerospace, and industrial applications

Ref: S.L. Hermann, "Explosives Data Guide", Explosives Research Institute, Inc, Scottsdale, Ariz (1977), 43

Xenon And Its Compounds

Xenon. Xe; at w 131.30; at no 59, valence 0, 2, 4, 6, & 8; nine stable isomers, 124 (0.096%), 126 (0.090%), 128 (1.919%), 129 (26.44%), 130 (4.08%), 131 (21.18%), 132 (26.89%), 134 (10.44%) & 136 (8.87%); 22 unstable or radioactive isomers, 118-123, 125, 127, 133, 135, 137-144; odorless, colorless "inert" gas or liq; mp - 111.9°; bp - 107.1 ± 3°; d 5.887 ± 0.009g/l (gas), liq is 2.987g/cc. Sl sol in cold w; v sl sol in hot w. CA Registry No [7440-63-3]. The gas is present in the atm to the extent of one p in 20 million. The element is found in the gases evolved from certain mineral springs and is commercially obt'd by extraction from liq air

Prentice et al (Ref 2) report on the use of a Xe flash lamp appar (Fig 1) as an ign source and combstn environment to study the ignitability, burning mode and time-to-expln of various metal fuels. The lamp appar is used as a rocket motor environment simulation in this investigation to explore the effect of particle size (200 to 500 microns), changing the gaseous atm, and varying the pressure regimes on metal fuels such as Al, B, Be, Mg, Ti and Zr

These workers found that it is easily possible using this appar, to raise the temp of properly prep'd solids several thousand degrees centigrade in a few microseconds. The Xe lamp heat source can be isolated from the atm and has a brightness temp of 10000°K. High speed photography

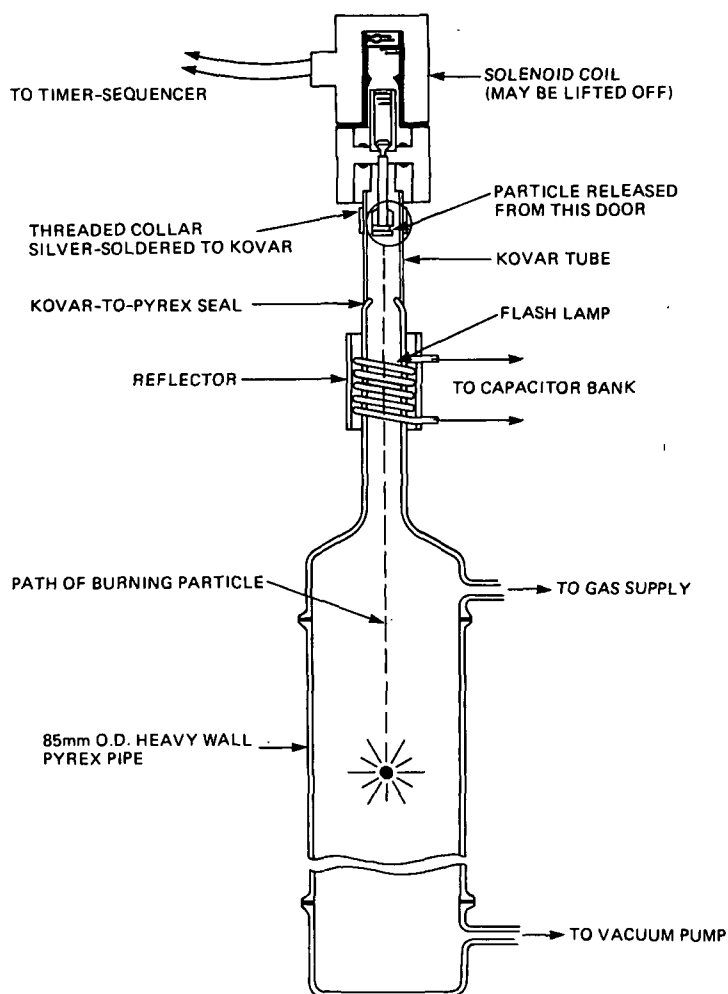

Fig 1 Diagram of Xenon Flash Heating Apparatus Showing Method of Release and Trajectory of Burning Particle (from Ref 2)

shows that the heat flux generated by this source is sufficient to cause the expln of fuel particles subjected to it. The time-to-expln of various particle sizes of Al, Ti and Zr is shown in Fig 2

According to Wright (Ref 3), Xe flash lamps have long been used to pump ruby lasers, obtaining brightness temps of from 8 to 12000°K, but requiring massive power sources. To eliminate this drawback, Wright undertook the development of a low weight, highly portable, chemical laser pumping source. For this purpose he explored the area of detonation pumping of

neodymium-glass using a cyanogen-oxygen mixt doped with Xe. He reports a brightness temp of 8000°K for over 200 msec from this compact source, sufficient to accomplish high-order lasing of neodymium-glass laser rod. Kern et al (Ref 4) report on the use of Xe as an inert gas blanket in nuclear electrical power generating reactors. The pressure oscillations of the Xe under varying thermal load conditions requires computerized control rod positioning to prevent disastrous Xe-induced spatial power surges (oscillations) and to maintain thermal margins at the rated power of the system. Higgins and

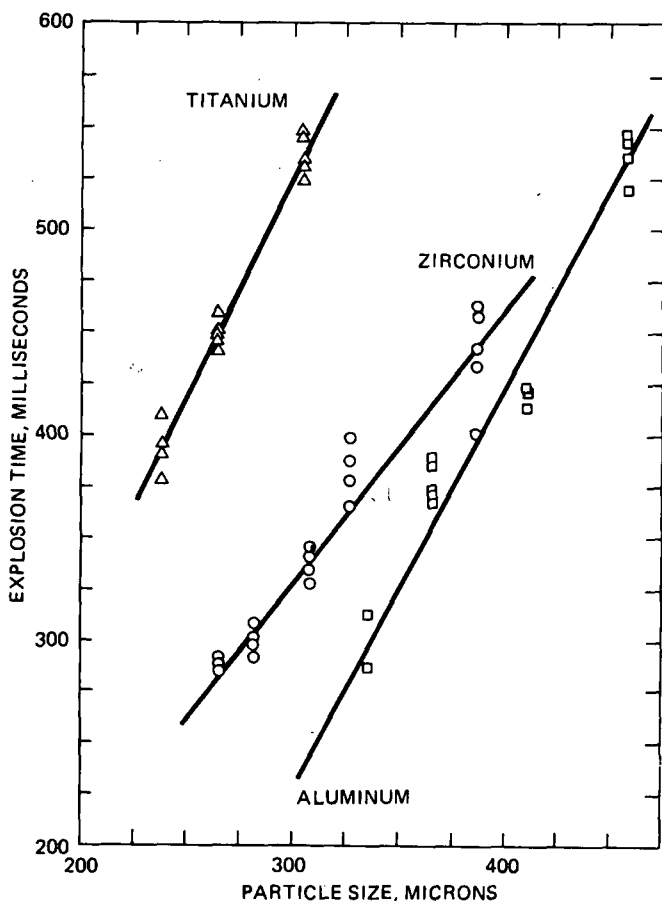

Fig 2 Plot Comparing the Variation of the Time to Explode Versus Particle Size for Flash-Ignited Particles of Al, Ti and Zr Burning in Ambient Air

Kinsey (Ref 5) also report on the use of a Xe-filled quartz lamp to initiate sprayed Pb Azide. Using a low-inductance, high-voltage power system, these workers developed a 3 microsecond rise-time UV light source capable of initiating sprayed Pb Azide at distances up to 4" with a max deviation of ± 1 microsecond. According to the authors, the 5' long lamp is operated at 53k volts and exceeds the required 4 J/cm^2 incident energy output needed for the initiation of Pb Azide. They feel that transition from a lab to a field operational device is entirely possible.

Sax (Ref 3a) considers Xe to be a simple asphyxiant

Entered below are the expl derivatives of Xe. It is to be noted that all Xe compds are highly toxic by inhalation, are strong oxidizing agents, and strong irritants (Ref 7, p 931)

Refs: 1) Gmelin, Syst No 1 (formerly No 5) (1926), reprint (1963); 1st supplement (1970)
 2) J.L. Prentice, Ed, "Metal Particle Combustion Progress Report, 1 July 1965-1 May 1967", NWCTP-4435 (1968) (AD839526) 3) J.L. Wright, "Chemical Laser Pump", FRLTM, PicArns, Dover (1966) (AD634655)
 3a) Sax (1968); 1237 4) R. Kern et al, "Optimum Spatial Flux Control Project: Phase II - Xenon Oscillation Studies for the Pickering Reactor", CEND-3932-2, Combustion Engineering, Windsor, Contract AT (30-1) - 3932 (1969)
 5) P.B. Higgins & C.H. Kinsey, "Development of Xenon Lamp Explosives Initiator", SC-DR-70-306, Sandia Corp, Albuquerque (1970)
 6) Merck (1976), 1300 (No 9738) 7) Cond ChemDict (1977), 930-1 8) ChemRubber Hndbk (1978), B-57

Alkali Fluoro-Xenates (VI). $\text{MXeO}_3 \cdot \text{F}$ (M=K, Rb or Cs); colorl hydr cryst; mp $> 260^\circ$ (decompn), expln at $> 300^\circ$. Sol in hot w. Prepn is by evapn of an aq soln contg equal vols of 0.5 molar XeO_3 and 1 molar KF plus a few drops of HF

Ref: J.C. Bailar et al, Eds, "Comprehensive Inorganic Chemistry", Vol 1, Pergamon Press Oxford (1973), 319

Cesium Chloro-Xenate. $\text{CsXeO}_3 \cdot \text{Cl}$; mw 306.66; white cryst; mp 205° (explds in vac). Sol in acetonitrile and hot w. Prepn is by reacting aq solns of approx 2cc of 1.5 molar Cs chloride with 0.4cc of 1.5 molar Xe trioxide at 0° , and allowing the mixt to stand for 3 hrs

Ref: J.C. Bailar et al, Eds, "Comprehensive Inorganic Chemistry", Vol 1, Pergamon Press Oxford (1973), 319

Monoalkali Xenates. $\text{MXeO}_4 \cdot 1.5\text{H}_2\text{O}$, (M = Na, K, Rb or Cs); colorl cryst. Sol in w; not sol in ethyl, t-butyl or methyl alcohols, chl and C tetrachloride. Prepn is by lyophilization of 0.1 molar XeO_3 and an alkali hydroxide in a 1:1 ratio. The salts are susceptible to detonation

Ref: J.C. Bailar et al, Eds, "Comprehensive Inorganic Chemistry", Vol 1, Pergamon Press Oxford (1973), 318

Xenon Dioxide Difluoride. XeO_2F_2 ; mw 201.30; colorl solid, liq; vap; mp 30.80° . Prepn is by distilling Xe oxytetrafluoride into Xe trioxide at dry ice temp, and then fractionally distilling off the unreacted Xe oxytetrafluoride along with the by-product Xe difluoride, leaving the product. According to Holloway, samples of Xe dioxide-difluoride have expld

Refs: 1) J.H. Holloway, "Noble Gas Chemistry", Methuen, London (1968), 132-34 2) J.C. Bailar et al, Eds, "Comprehensive Inorganic Chemistry", Vol 1, Pergamon Press, Oxford (1973), 307-09

Xenon Fluorides

Xenon Difluoride. XeF_2 ; mw 169.30; colorl linear cryst with a body-centered tetragonal cell structure, possessing a nauseating odor; mp $129.03 \pm 0.05^\circ$; d 4.32g/cc. V sol in liq anhydr HF; moderately sol in w. Prepn is by reacting two moles of Xe with one mole of fluorine in a Ni or Monel vessel at 400° , quenching the reaction at RT, and isolating the product by vac sublimation. Ref 2 lists nine other techniques for the prepn of the difluoride. The pure compd is stable and can be kept indefinitely in Ni or Monel containers

According to Kliniov et al (Ref 3) the difluoride is resistant to detonation, however its extreme reactivity causes explns when brought into contact with acet, polyethylene, wool, paper, sawdust, Al foil, ferric carbonyl, lubricants and styrene. Gibson et al (Ref 5) also report that at temps of from -30 to -25° an expl reaction occurs with dimethylaminotrimethylsilane

Refs: 1) F.A. Cotton & G. Wilkinson, "Advanced Inorganic Chemistry", Interscience, NY (1966), 594 2) J.H. Holloway, "Noble-Gas Chemistry", Methuen, London (1968), 108-14 3) B.D. Klimov et al, "Explosion Hazard During Work With Fluorine Containing Xenon Compounds", ZhPriklKhim (Leningrad) 42 (12), 2822-4 (1969) & CA 72, 85784 (1970) 4) J.C. Bailar et al, Eds, "Comprehensive Inorganic Chemistry", Vol 1, Pergamon Press, Oxford (1973), 252 ff; 498-99 5) J.A. Gibson et al, "Reaction of Xenon Difluoride. . .", CanJ Chem 53 (20), 3044-52 (1975) & CA 84, 44286 (1976)

Xenon Tetrafluoride. XeF_4 ; mw 207.30; colorl square or planar crystals; mp 114° , 117° (separate values). V sol in anhydr liq HF; sol in tetrafluoroacetic acid; not sol in perfluoroheptane. Quant prepn is by an electrical discharge technique where a F_2/Xe mixt in the molar ratio of 2:1 is reacted at an operating pressure of from 2 to 15mm at -78° in a suitable vessel (Ref 4, p 282). The fluoride is very readily hydrolyzed to the highly shock sensitive Xe oxides by traces of moisture (Ref 3)

According to Klimov (Ref 2) the tetrafluoride is resistant to deton. However, because of its high reactivity, very sensitive explns result from contact with flammable materials such as acet, polyethylene, wool, paper, sawdust, Al foil, ferric carbonyl, lubricants or styrene

Refs: 1) J.H. Holloway, "Noble-Gas Chemistry", Methuen, London (1968), 95 ff 2) B.D. Klimov et al, "Explosion Hazard During Work With Fluorine Containing Xenon Compounds", Zh Prikl Khim (Leningrad) 42 (12), 2822-24 (1969) & CA 72, 85784 (1970) 3) T.C. Shieh et al, "Reaction of Xenon Fluorides With Organic Compounds", J OrgChem 35 (12), 4020-24 (1970) & CA 74, 22488 (1971) 4) J.C. Bailar et al, Eds, "Comprehensive Inorganic Chemistry", Vol 1, Pergamon Press, Oxford (1973), 282 ff & 499ff

Xenon Hexafluoride. XeF_6 ; mw 245.30; distorted octahedral molecular structure forming cubic (below 301°K) and monoclinic colorl crystals; mp 49.6° ; d 3.465 g/cc. Sol in anhydr HF (liq), WF_6 , IF_5 and BrF_5 . A yield of 95% of the hexafluoride is obtd with a F_2/Xe ratio of 20:1 at 50 atms pressure and -115° , using Ni or Monel reaction vessels. An alternative high yield prepn consists of heating an excess of F_2 with Xe in a sealed stainless steel can at 60 atms pressure and 300° . The compd reacts with great violence with H and produces the extremely sensitive expl Xe trioxide in reactions with either quartz (SiO_2) or w

Refs: 1) G.L. Gard & G. H. Cady, "Reactions of Xenon Hexafluoride With the Substances: SbF_5 , HCl, NH_3 and $\text{C-C}_5\text{F}_8$ ", ONR TR49, Univ Wash, Seattle, Contract ONnr-477 (16) (1964) 2) J.H. Holloway, "Noble-Gas Chemistry", Methuen, London (1968), 100 & 122-28 3) J.C. Bailor et al, Eds, "Comprehensive In-

organic Chemistry", Vol 1, Pergamon Press, Oxford (1973), 294-302, 499 & 500

4) Anon, "Fire Protection Guide On Hazardous Materials - 7th Edition", NFPA, Boston (1978), 491M-440 5) Bretherick (1979), 908-09

Xenon (II) Fluoride Methanesulphonate.

$\text{CH}_3\text{FO}_3\text{SXe}$; mw 245.40; v pale yel solid; mp, explds on warming from 0° to RT. Prepn is by reacting Xe difluoride with one mole of methane sulfonic acid initially at -110° , and completing the reaction by warming to -63°

Refs: 1) J.C. Bailar et al, Eds, "Comprehensive Organic Chemistry", Vol 1, Pergamon Press, Oxford (1973), 272 2) Bretherick (1979), 303

Xenon (II) Fluoride Trifluoromethane-sulfonate.

$\text{FXeOSO}_2\text{CF}_3$; mw 299.37; colorl solid; mp, decompn at RT; if an excess of Xe difluoride is used in the prepn, the product will expld violently on warming to RT. Prepn is by reacting one mole of Xe difluoride with two moles of anhydr methane sulphonic acid initially at -110° , then completing the reaction at -63°

Refs: 1) J.C. Bailar et al, Eds, "Comprehensive Inorganic Chemistry", Pergamon Press, Oxford (1973), 272 ff 2) Bretherick (1979), 286

Xenon Fluoro Perchlorate. (Xenon (II) fluoride perchlorate).

FXeClO_4 ; mw 249.75; colorl solid, red liq; mp 16.5° (decompn); bp, detonates when heated rapidly above 20° . Sol in acetonitrile. Prepn is by reacting Xe difluoride with perchloric acid initially at -110° , then to reaction completion at -60°

Refs: 1) M. Wechsberg et al, "... Perchlorates of Xenon (II) ...", Inorg Chem 11 (12), 3065 (1972) & CA 78, 110041 (1973) 2) N. Bartlett et al, "Xenon (II) ... and Related Compounds", Chem Communications, 703-04 (1969) 3) J.C. Bailar et al, Eds, "Comprehensive Inorganic Chemistry", Vol 1, Pergamon Press, Oxford (1973), 270

Xenon Orthotellurate. (Xenon bis (pentafluoroorthotellurate)). $\text{Xe}(\text{OTeF}_5)_2$; mw 369.89; colorl cryst; mp $35-7^\circ$. Sol in acetonitrile and C tetrachloride. Prepn in 97% yield is by treating Xe difluoride with 2 moles of anhydr HOTeF_5 . The compd reacts explosively with acet, benz and ethanol

Refs: 1) F.Sladky, " $\text{Xe}(\text{OTeF}_5)_2$, Xenon Bis (pentafluoroorthotellurate)", Ang Chem Internl Edn, Vol 8 (7), 523 (1969)

2) J.C. Bailar et al, Eds, "Comprehensive Inorganic Chemistry", Vol 1, Pergamon Press, Oxford (1973), 272-73

Xenon Oxide Difluoride. XeOF_2 ; mw 185.20; bright yel solid; mp -25° to -15° (decompn occurs on slow warming, warming at $>20^\circ/\text{hr}$ leads to expln). Prepn is by co-condensation of w and Xe tetrafluoride under vac at -196° , warming to -80° and then to -63° for 2 hrs, and finally to -47° for 1 hr. The compd explds in contact with Sb pentafluoride or As pentafluoride at -196° , also when in contact with solid Hg

Refs: 1) J.C. Bailar et al, Eds, "Comprehensive Inorganic Chemistry", Vol 1, Pergamon Press, Oxford (1973), 292-3 2) E. Jacobs et al, "Xenon Oxide Difluoride, XeOF_2 ", Ang Chem (Intl Edn Engl) 15 (3), 158-9 (1976) & CA 84, 144098 (1976)

Xenon Oxide Tetrafluoride (or Xenon tetrafluoride oxide). XeOF_4 ; mw 223.30; colorl liq, stable at RT; mp -28° ; d 3.168 - .00327Tg/cc. Prepn is by reaction of XeF_6 with w or silica. Silig (Ref 3) reports that the graphite - XeOF_4 intercalation compd exploded in contact with KI soln

Refs: 1) H.H. Hyman, "Noble-Gas Compounds", Univ Chicago Press (1963), 106-08 2) J.C. Bailar et al, Eds, "Comprehensive Inorganic Chemistry". Vol 1, Pergamon Press, Oxford (1973), 303-07 3) H. Selig et al, Inorg Nucl Lett 11 (1), 75-77 (1975)

Xenon (II) Pentafluoroorthoselenate. $\text{Xe}[\text{F}_5\text{SeO}]_2$; mw 512.20; bright yel cryst; mp 130° (decompn). Sol in acetonitrile and C tetrachloride. Prepn is by treating Xe difluoride with 2 moles of anhydr selenic acid. The compd reacts explosively with oxidizable substances
Ref: K. Seppert, *Ang Chem (Internl Edn Engl)* **11**, 723-4 (1972)

Xenon Perchlorate (Xenon (II) bis perchlorate). $\text{Xe}(\text{ClO}_4)_2$; mw 330.01; pale yel solid decomp to a red liq; mp, detonates when heated over 20° . Sol in acetonitrile. Prepn is by treating Xe difluoride with 2 moles of anhydr perchloric acid initially at -110° , and completing the reaction at -60°
Refs: 1) M. Wechsberg et al, "... Perchlorates of Xenon (II) . . .", *InorgChem*, Vol **11** (12), 3066 (1972) 2) J.C. Bailar et al, Eds, "Comprehensive Inorganic Chemistry", Vol **1**, Pergamon Press, Oxford (1973), 272-3

Xenon Tetrahydroxide. $\text{Xe}(\text{OH})_4$. mw 199.34; mp, explds violently on heating. Prepn is by hydrolysis of Xe difluoride
Refs: 1) G. Sorbe, "Giftige und Explosive Substanzen", Unischau, Verlag (1968), 158 2) J.C. Bailar et al, Eds, "Comprehensive Inorganic Chemistry", Vol **1**, Pergamon Press, Oxford (1973), 268

Xenon Tetroxide. See in Vol **8**, 053-L and in the following *Addnl Ref:* H. Selig et al, "Xenon Tetroxide: Preparation and Some Properties", *Science* **143**, 1322-3 (1964). [The compd is reported as a yel solid at below -78.5° . The IR spectrum of the vapor shows it to have tetrahedral symmetry]

Xenon Trifluoroacetate. $\text{Xe}(\text{OCOCF}_3)_2$; mw 357.33; pale yel solid: mp, when heated above 20° the compd detonates. Sol in acetonitrile and C tetrachloride. Prepn is by treating Xe difluoride with 2 moles of anhydr trifluoroacetic acid
Ref: J.C. Bailar et al, Eds, "Comprehensive Inorganic Chemistry", Vol **1**, Pergamon Press, Oxford (1973), 270-73

Xenon Trioxide. See in Vol **8**, 053-L and in the following *Addnl Refs:* 1) Anon, "Hydrolysis of Xe Fluorides gives XeO_3 ", *C & EN* **41** (13), 45 (1963) [The stabilizing effect of a trace of sulfuric acid in the prepn of Xe trioxide is reported. It has been found that 10 cc of w contg 4 microliters of 1 molar sulfuric acid can be used for the hydrolysis of 1 g of Xe tetrafluoride. The product is said to be less sensitive to manipulation and does not detonate as readily as the compd prepd otherwise] 2) H.H. Hyman, *Science* **145**, 773-83 (Aug 21, 1964) [The reported RI's of the trioxide are: α is 1.79 and γ is > 1.8] 3) J.H. Holloway, "Explosion Hazards With Xenon Trioxide Solutions ("Xenic Acid")", *Talanta* **14**, Pergamon Press, N Ireland (1967), 871-3 [Accdg to this worker all Xe compds must be treated as potential sources of the expl Xe trioxide. Also, Xe fluorides and oxide fluorides, if contaminated with organic materials, should also be treated as sensitive expls]

X-Explosives from LASL. The Los Alamos National Scientific Laboratory (LASL) symbols for research expls carry the designation X followed by a four-digit number. Tables 1 and 2 (from Ref 1) list a chemical description and densities and melting points, respectively, of typical formulations

Table 1
Chemical Properties of LASL Research Explosives

Explosive	Constituents	Weight Percent	Volume Percent	Molecular Formula	Molecular Weight
Plastic-Bonded DATB^a					
X-2043	DATB	95	91.5	$C_6H_5N_5O_6$	243.14
	Polystyrene	3.5	5.8	$(C_8H_8)_n$	$(104.15)_n$
	DOP ^b	1.5	2.7	$C_{24}H_{34}O_4$	386.53
X-0300	DATB	95	92.4	$C_6H_5N_5O_6$	243.10
	Estane ^c	5	7.5	$C_{5.1}H_{7.5}N_{0.19}O_{1.76}$	100
X-0247	DATB	95	95	$C_6H_5N_5O_6$	243.14
	Kel-F	5	5	$(CFCICF_2CH_2CF_2)_n$	$(180.51)_n$
X-0299	DATB	95	94.9	$C_6H_5N_5O_6$	243.10
	Viton A	5	5.1	$(C_5H_{3.5}F_{6.5})_n$	$(187.07)_n$
Plastic-Bonded HMX					
X-0217	HMX	94	92.2	$C_4H_8N_8O_8$	296.17
	DNPA	3.6	4.6	$(C_6H_6N_6O_6)_n$	$(258.06)_n$
	NP ^d	2.4	3.2	$C_7H_{12}N_4O_{10}/$ $C_8H_{14}N_4O_{10}$	312.21/ 326.22
X-0234-50	HMX	94	92.3	$C_4H_8N_8O_8$	296.17
	DNPA ^e	3	3.8	$(C_6H_6N_6O_6)_n$	$(258.06)_n$
	CEF ^f	3	3.9	$C_6H_{12}O_4Cl_3P$	285.52
X-0234-60	HMX	94	92.3	$C_4H_8N_8O_8$	296.17
	DNPA	3.6	4.5	$(C_6H_6N_6O_6)_n$	$(258.06)_n$
	CEF	2.4	3.2	$C_6H_{12}O_4Cl_3P$	285.52
X-0234-70	HMX	94	92.3	$C_4H_8N_8O_8$	296.17
	DNPA	4.2	5.3	$(C_6H_6N_6O_6)_n$	$(258.06)_n$
	CEF	1.8	2.4	$C_6H_{12}O_4Cl_3P$	285.52
X-0234-80	HMX	94.0	92.3	$C_4H_8N_8O_8$	296.17
	DNPA	4.8	6.1	$(C_6H_6N_6O_6)_n$	$(258.06)_n$
	CEF	1.2	1.6	$C_6H_{12}O_4Cl_3P$	285.52
X-0286	HMX	97	93.8	$C_4H_8N_8O_8$	296.17
	Kraton	1.35	2.7	Proprietary	
	Oil	1.65	3.5	$(CH_2)_n$	$(14.03)_n$
X-0287	HMX	97.5	93.8	$C_4H_8N_8O_8$	296.17
	Kraton	1.43	3.9	Proprietary	
	Wax ^g	1.17	2.3	$(CH_2)_n$	$(14.03)_n$
X-0298	HMX	97.5	93.7	$C_4H_8N_8O_8$	296.17
	Kraton	1.43	3.9	Proprietary	
	High Vacuum Oil	1.17	2.4	$(CH_2)_n$	$(14.03)_n$
X-0233-13-85	HMX	13.2	55	$C_4H_8N_8O_8$	296.17
	W	85.5	35	W	183.85
	Polystyrene	0.8	6	$(C_8H_8)_n$	$(104.14)_n$
X-0118	DOP	0.5	4	$C_{24}H_{24}O_4$	386.51
	HMX	29.7	27.4	$C_4H_8N_8O_8$	296.17
	NQ	64.9	64.6	$CH_4N_4O_2$	104.1
	Estane	5.4	8	$C_{5.1}H_{7.5}N_{0.19}O_{1.76}$	100

(continued)

Table 1 (continuation)

<u>Explosive</u>	<u>Constituents</u>	<u>Weight Percent</u>	<u>Volume Percent</u>	<u>Molecular Formula</u>	<u>Molecular Weight</u>
Plastic-Bonded HMX (cont'd)					
X-0114	HMX	65.7	64.3	$C_4H_8N_8O_8$	296.17
	NQ	26.4	27.8	$CH_4N_4O_2$	104.1
	Kel-F	7.9	7.9	$(CFCICF_2CH_2CF_2)_n$	$(180.51)_n$
X-0204	HMX	83	84.3	$C_4H_8N_8O_8$	296.17
	Teflon	17	15.7	$(CF_2)_n$	$(40.01)_n$
X-0007	HMX	86.4	79.9	$C_4H_8N_8O_8$	296.17
	Estane	13.6	20	$C_{5.1}H_{7.5}N_{0.19}O_{1.76}$	100
X-0009	HMX	93.4	89.7	$C_4H_8N_8O_8$	296.17
	Estane	6.6	10.3	$C_{5.1}H_{7.5}N_{0.19}O_{1.76}$	100

Footnotes to Table 1:

a - 1,3-Diamino-2,4,6-trinitrobenzene
 b - Di-2-ethylhexylphthalate
 c - A polyester polyurethane
 d - Nitroplasticizer

e - 2,2-Dinitropropylacrylate
 f - Tris-beta chloroethylphosphate
 g - Any of a series of petroleum-based paraffins

The reader is referred to Ref 1 for a voluminous compilation of detonation properties (detonation velocity and diameter effect, cylinder test performance, plate dent test and detonation failure thickness), shock initiation properties (wedge test data and small - and large - scale gap tests), and sensitivity tests (skid test, large-scale drop test or spigot test and spark sensitivity) relevant to LASL research expls

Refs: 1) T.R. Gibbs & A. Popolato, "LASL Explosive Property Data", Univ of California Press, Berkeley (1980) 2) B.M. Dobratz, "LLNL Explosives Handbook - Properties of Chemical Explosives and Explosive Simulants", UCRL-52997, Lawrence Livermore Laboratory, Livermore, Calif (1981), p 18-1

X 10

Table 2
Densities and Melting Points of LASL Research Explosives

Explosive	Constituents	Densities of Constituents	Mixture		Melting Point °C
			Theoretical	Typical	
DATB-Bonded Explosives					
X-0243	DATB	1.837	1.786	1.750	285d
	Polystyrene	1.054			
	DOP	0.986			
X-0300	DATB	1.837	1.789	1.750	285d
	Estane	1.19			
X-0247	DATB	1.837	1.845	1.810	285d
	Kel-F	2.02			
X-0299	DATB	1.837	1.835	1.800	285d
	Viton A	1.815			
HMX-Bonded Explosives					
X-0217	HMX	1.905	1.869	1.835	278d
	DNPA	1.477			
	NP	1.39			
X-0234-50	HMX	1.905	1.870	1.847	278d
	DNPA	1.477			
	CEF	1.425			
X-0234-60	HMX	1.905	1.870	1.845	278d
	DNPA	1.477			
	CEF	1.425			
X-0234-70	HMX	1.905	1.870	1.843	278d
	DNPA	1.477			
	CEF	1.425			
X-0234-80	HMX	1.905	1.870	1.840	278d
	DNPA	1.477			
	CEF	1.425			
X-0286	HMX	1.905	1.842		278d
	Kraton	0.91			
	Oil	0.873			
X-0287	HMX	0.905	1.833		278d
	Kraton	0.91			
	Wax	0.93			
X-0298	HMX	1.905	1.830		278d
	Kraton	0.91			
	High Vacuum Oil	0.87			
X-0233-13-85	HMX	1.905	7.903	7.5-7.9	278d
	W	19.3			
	Polystyrene	1.054			
	DOP	0.986			
X-0118	HMX	1.905	1.761	1.712	278d
	NQ	1.76-1.78			
	Estane	1.19			
X-0114	HMX	1.905	1.863	1.815	240d
	NQ	1.76-1.78			
	Kel-F	1.85			
X-0204	HMX	1.905	1.953	1.915	278d
	Teflon	2.1			

Xilit. Russ for Trinitroxylyene

Ref: R. Meyer, "Explosives", Verlag Chemie, NY (1977), 358

Xpdite. An older US coal mining expl on the Permissible List. It was made by the Hercules Powder Co, and contained NG

Ref: Marshall, Dict (1920), 103

X-Rays, Action on Energetic Materials. See under "Radiation Effects on Explosives, Propellants and Pyrotechnics" in Vol 9, R42-2 to R43-R

X-Ray Diffraction Analysis of Energetic Materials.

The established method for the identification of crystalline materials is x-ray powder or single crystal diffraction. In these techniques a polycrystalline phase (or form of a substance) diffracts a monochromatic beam of x-rays according to the Bragg relation, $n\lambda = 2d \sin \theta$ (where λ is the wave length in microns and d is the interplanar spacing in Å), into a spectrum or "pattern" of interference reflections which can be recorded on photographic film or by ionization chambers or other x-ray detecting devices. Each reflection (peaked lines, arcs or dots - depending on technique) is associated with a position and an intensity and represents a particular family of crystal lattice planes of the phase. Since the sequence of planes (in interplanar spacing and x-ray scattering power) of a crystal is unique to that crystal, the x-ray diffraction pattern itself is unique to that phase and can serve a "fingerprint" identification of the phase or substance of the subject compd (Refs 8, 13, & 14)

Abel and Kemmey (Ref 16) report that the generally accepted exptl procedures for producing diffraction data from energetic materials favors the use of an x-ray diffractometer, and a Debye-Scherrer or Gandolfi camera. When the x-ray diffractometer is used, samples are prep'd as recommended by the NBS (Ref 6). A Si external standard is usually used to test the alignment of the diffractometer. A 25% by wt Ag internal standard is also used whenever possible, and linear interpolation corrections are

applied to the reflections over the length of the diffractograms. The diffractogram is generally obtained using nickel-filtered $\text{CuK}\alpha$ radiation. X-ray analysis can also be performed with radiation from Fe, Mo, Co, or Cr tubes with appropriate filters. A scanning speed of $1^\circ/2\theta$ / minute is normally used for the diffractometer, and film exposure times of from 10 to 20 hours are not uncommon (Refs 3, 8, 14 & 16)

A 114.6mm diam Debye-Scherrer camera is usually used for samples weighing from 10 to 15mgs. The sample prep'n methods and interpretation procedures recommended by Azaroff and Buerger (Ref 3) are usually followed, exercising every safety precaution as appropriate.

When the Gandolfi camera is used, a single crystal or crystal fragment is mounted on a glass capillary (Refs 11 & 19). This camera is thus of great value when a very small amount of the phase to be investigated is available

In a situation where metastable phases are to be investigated, data can be taken under pressure-temp conditions other than standard. For this type of measurement, the high temp Siemens system or the high pressure McWhan or Bassett cameras can be used

The data, obtained through use of the equipment mentioned above, is tabulated in the format used in the ASTM "Powder Diffraction File" (Refs 4, 6, 10, 21 & 22). Likewise, the format and conventions of the "International Tables for X-Ray Crystallography" (Ref 5) are usually also adhered to closely

The primary source of x-ray crystal diffraction reference data is the above-mentioned ASTM "Powder Diffraction File", published by the Joint Committee on Powder Diffraction Standards. This file consists of over 38000 diffraction patterns of crystalline materials including expls and related materials. Scientists in the expls field routinely utilize this source for the identification of expls and metastable phases by comparing the interplanar d spacings and intensities of exptl phases with those of known phases (Refs 4, 10, 21 & 22)

Manual search identification data for various crystalline energetic materials, drawn from the above file and other sources are presented in Tables 1 (inorganic) and 2 (organic). The strongest reflections (the most intense on film or the highest in amplitude on a recorder chart) of the

Table 1
X-Ray Diffraction Data of a Selected Group of Inorganic Energetic Materials

Compound	Diffraction Pattern Spacing, Å	Intensity, %	Refs
Aluminum, Al	2.34-2.02-1.22-1.43-0.93-0.91-0.63-1.17	100-47-24->24->24->24->24->24->24	4; 13
Ammonium Azide, NH ₄ N ₃	2.90-2.86-3.11	100-100-70	4
Ammonium Nitrate, NH ₄ NO ₃			
at 100°	3.17-4.12-2.89	100-70-60	4
at 155°	4.42-3.12-2.21	100-100-50	4
Form III	2.64-3.25-3.40	100-90-70	4
Form IV	3.09-2.72-3.96	100-75-67	4
Form V	3.09-2.67-2.25	100-80-80	4
Ammonium Perchlorate, NH ₄ ClO ₄	4.58-3.61-3.25-3.92-2.97-3.72-2.60	100-61-51-43-42-33-29	4; 10
at 243°	4.43-3.85-2.71	100-100-70	4
Barium Azide, Ba(N ₃) ₂	4.07-3.40-3.09	100-70-70	4
Barium Nitrate, Ba(NO ₃) ₂	2.45-4.68-2.34-4.06-2.87-1.91-1.86-1.37	100-95-55->55->55->55->55->55	4; 13
Copper Azide, CuN ₃	3.06-4.69-3.18	100-80-80	4
Hydrazine Nitrate, (NH ₂) ₂ .HNO ₃	3.34-2.70-4.10	100-90-80	4
α-Lead Azide, Pb(N ₃) ₂	4.84-3.08-2.81-4.13-2.69-2.00-2.55-2.28	100-90-90->90->90->90->90	4; 13
β-Lead Azide, Pb(N ₃) ₂	2.91-3.98-4.92-4.41-2.45-2.01-2.22-1.77	100-90-70->70->70->70->70	4; 13
Magnesium, Mg	2.45-2.61-2.78	100-41-35	4
Mercury Fulminate, HgC ₂ N ₂ O ₂	4.02-2.70-2.25-3.80-2.21-2.02-1.70-3.05	100-80-60->60->60->60->60	4; 13
Potassium Azide, KN ₃	2.75-3.05-2.55	100-33-13	4
Potassium Chlorate, KClO ₃	3.46-2.88-2.80	100-25-25	4
Potassium Nitrate, KNO ₃	3.78-3.73-3.03	100-56-55	4
at 115° Form III	3.27-2.28-2.70	100-90-80	4
Potassium Perchlorate, KClO ₄	3.49-3.15-2.89	100-78-67	4
Silver Azide, AgN ₃	2.41-4.08-2.04	100-80-80	4
Silver Fulminate, AgCNO	5.25-2.54-3.59	100-90-75	4
Sodium Azide, NaN ₃	2.91-1.82-2.42	100-40-20	4
Sulfur Nitride, S ₄ N ₄	3.10-2.77-2.71-1.799-1.582-1.543	100-50-50-35-30-30	18
Uranium, U	2.52-2.56-2.28	100-70-60	4
Xenon, Xe	3.61-3.13-2.21	100-70-70	4
Zinc, Zn	2.09-2.47-2.31	100-53-40	4
α-Zirconium, Zr	2.46-2.80-2.57	100-33-32	4

Table 2
X-Ray Diffraction Data for Selected Energetic Material Organic Compounds

Compound	Diffraction Pattern Spacing, Å	Intensity in Both Relative Terms and in Percent	Refs
2-Acetyl-4,6,8-Trinitrocyclotetramethylenetetramine, C ₆ H ₁₁ N ₇ O ₇	4.74-4.01-6.95	100-100-70	10
5-Aminotetrazole Nitrate, CH ₄ N ₆ O ₃	5.31-3.55-2.12	100-71-41	10
Ammonium Picrate Hydrate, C ₆ H ₆ N ₄ O ₇ ·H ₂ O	3.16-3.95-3.40	100-72-72	10
m-Azotoluene, C ₁₄ H ₁₄ N ₂	4.40-3.75-5.76	100-40-14	10
Butadiene, C ₄ H ₆	3.55-3.47-4.67	100-100-80	10
DATB, C ₆ H ₃ N ₅ O ₆	7.34-2.96-4.43-3.53-5.86-4.07	VVS-VS-S-S-M-M ^a	6
Diethyl Magnesium, C ₄ H ₁₀ Mg	6.05-4.01-3.67	100-100-80	10
Dihydroxyethylnitramine Dinitrate, C ₂ H ₂ N ₄ O ₆	4.97-4.20-3.47-3.01-2.74-2.64-2.33	S-S-S-M-M-M ^a	1
2,4-Dinitroaniline, C ₆ H ₅ N ₃ O ₄	3.20-4.55-4.79	100-85-80	10
2,4-Dinitroanisole, C ₇ H ₆ N ₂ O ₅	3.60-3.41-6.49	100-40-18	10
m-Dinitrobenzene, C ₆ H ₄ N ₂ O ₆	4.22-4.43-6.24	100-75-65	10
p-Dinitrobenzene, C ₆ H ₄ N ₂ O ₆	3.17-5.15-3.89	100-75-65	10
2,4-Dinitrotoluene, C ₇ H ₆ N ₂ O ₄	3.32-3.22-9.88	100-100-90	10
2,6-Dinitrotoluene, C ₇ H ₆ N ₂ O ₄	6.86-3.56-3.35	100-90-80	10
Dioxane Al Perchlorate Hydrate, C ₁₆ H ₃₂ AlCl ₃ O ₂ ·7H ₂ O	4.28-4.65-8.55	100-50-40	10
Dioxane Ba Perchlorate, 2(C ₄ H ₈ O ₂)·Ba(ClO ₄) ₂	7.31-7.89-6.65	100-50-40	10
Dioxane Lead (II) Perchlorate, 2(C ₄ H ₈ O ₂)·Pb(ClO ₄) ₂	6.68-3.87-2.53	100-100-40	10
Dioxane Mercurous (I) Perchlorate Hydrate, 4(C ₄ H ₈ O ₂)·Hg(ClO ₄) ₂ ·2H ₂ O	9.86-8.96-4.01	100-80-80	10
Ethylene Dinitramine, C ₂ H ₆ N ₄ O ₄	3.39-3.08-4.57-5.39-2.96-2.56	S-S-(-)S-M-M-M ^a	1
Glycine Nitrate, CH ₂ N ₃ ·HNO ₃	4.16-4.53-3.13	100-90-80	10
Guanidine Nitrate, CH ₅ N ₃ ·HNO ₃	5.97-3.39-3.20	100-100-80	10
Guanidine 5-Nitroaminotetrazole, C ₂ H ₇ N ₉ O ₂	4.14-12.4-2.5	100-34-29	10
Guanidine Picrate, C ₇ H ₈ N ₆ O ₇	4.60-3.16-2.26	100-100-40	10
5-Guanylamino-tetrazole, C ₂ H ₅ N ₇	3.16-9.37-2.26	VVS-F-F ^a	1
5-Guanylamino-tetrazole Nitrate, C ₂ H ₆ N ₈ O ₃	3.18-5.01-5.44	100-36-14	10
2,4,6,2',6'-Hexanitrodiphenylamine, C ₁₂ H ₅ N ₇ O ₁₂	5.13-4.19-10.3	100-7-6	10
x-Hexanitrodiphenylamine, C ₁₂ H ₅ N ₇ O ₁₂	4.45-3.82-3.73	100-90-90-	10
	4.45-3.81-5.95	100-100-80	10

(continued)

Table 2 (continuation)

Compound	Diffraction Pattern Spacing, Å	Intensity in Both Relative Terms and in Percent	Refs
3-Hexanol-3,5-Dinitrobenzoate, $C_{13}H_{16}N_2O_6$	12.6-3.80-5.70	100-75-15	10
1-Hexanol-3,5-Dinitrobenzoate, $C_{13}H_{16}N_2O_6$	16.4-4.17-3.54	100-25-13	10
Hexol Nitrate, $C_{12}H_{42}Co_4N_{18}O_{24}$	12.8-8.78-7.62	100-80-80	10
High MW Nitropolymer	5.4-4.85-4.10-3.57-8.3-3.25-3.05	VS-VS-S-S-M-M-M ^a	2
Lead Styphnate (normal), $C_6H_3N_3O_9Pb$	7.82-2.95-4.41	100-90-80	10
Lead Styphnate (basic), $C_6H_2N_3O_{10}$	8.66-9.20-3.36-2.97-4.44-3.62-2.35-6.75	Not given	13
Methylaminotriphenyl Aluminum, $C_{19}H_{20}AlN$	4.90-4.62-4.37	100-80-60	10
5-Methylaminotetrazole, $C_2H_5N_5$	6.81-3.43-3.34	100-82-62	10
1-Methyl-5-Aminotetrazole, $C_2H_5N_5$	5.31-4.40-2.71	100-58-33	10
Nitramino Guanidine, $CH_5N_5O_2$	3.22-4.41-3.93	100-70-70	10
o-Nitroaniline, $C_6H_6N_2O_2$	5.86-3.26-3.80	100-100-65	10
m-Nitroaniline, $C_6H_6N_2O_2$	3.71-4.86-3.42	100-70-40	10
p-Nitroaniline, $C_6H_6N_2O_2$	3.49-4.62-3.83	100-80-80	10
Nitrocellulose, $C_{12}H_{25}NO_{15}$	5.34-3.90-2.57	100-100-80	10
Nitroguanidine, $CH_4N_4O_2$	5.07-4.14-2.38	100-80-70	1; 10
p-Nitrotoluene, $C_7H_7NO_2$	3.52-7.75-5.45	100-65-45	10
Octahydro-1,3,5,7-Tetranitro-s-Triazine	4.31-2.79-3.86-6.04-5.52-3.40-3.26-3.02	VS-VS-S-M-M-M-M ^a	1
Octahydro-1-Acetyl-3,5,7-Trinitro-s-Triazine	4.74-4.01-6.95-6.62-3.54-4.44-3.44-3.18	VS-VS-S-S-S-M-M-M ^a	1
PETN, $C_5H_8N_4O_9$	3.83-3.54-3.31	100-80-60	1; 10
Phenyl Mercurous (II) Hydroxide Nitrate, $C_{12}H_{11}HgNO_4$	14.4-4.18-3.36	100-20-20	10
1-Phenyl-5-Methyl Tetrazole, $C_8H_8N_4$	6.76-6.42-3.54	100-75-53	10
2-Phenyl-5-Methyltetrazole, $C_8H_8N_4$	9.92-4.63-3.46	100-68-29	10
5-Phenyl Tetrazole, $C_7H_6N_4$	7.64-3.64-3.21	100-34-30	10
1-Phenyl-Tetrazole, $C_7H_6N_4$	6.20-4.42-5.16	100-70-50	10
Picramic Acid, $C_6H_2N_3O_5$	6.60-3.29-3.18	100-70-70	10
Picric Acid, $C_6H_3N_3O_7$	3.75-3.85-4.82	100-70-50	10
5-Picrylamino-tetrazole, $C_7H_4N_8O_6$	18.8-3.31-3.84	100-60-40	10
Picrylaniline, $C_{12}H_8N_4O_6$	6.23-4.60-3.79	100-100-100	10
Picryl Chloride, $C_6H_2ClN_3O_6$	3.80-3.07-4.23	100-40-30	10
Picryl-p-Toluidine, $C_{13}H_{10}N_4O_6$	13.6-10.20-5.52-4.07-3.61-4.53	100-100-100-80-70	10
Pyridine Picrate, $C_{12}H_8N_4O_7$	4.39-4.20-3.60	100-100-90	10
Styphnic Acid, $C_6H_3N_3O_8$	3.70-2.610-6.28	100-60-40	10

(continued)

Table 2 (continuation)

Compound	Diffraction Pattern Spacing, Å	Intensity in Both Relative Terms and in Percent	Refs
Tetracene, $C_2H_8N_{10}O$	3.16-7.28-5.94-4.72-3.82-3.41-2.95	Not given	13
Tetramethylammonium Nitrate, $C_4H_{12}ClNO_4$	4.17-4.19-5.87	100-95-15	10
2,4,6,8-Tetranitrocyclo-tetramethylenetetramine, $C_4H_8N_8O_8$	4.31-2.79-3.86	100-100-70	10
Tetrazole, CH_2N_4	3.20-4.35-3.38	100-75-60	10
Tetryl, $C_7H_5N_5O_8$	7.00-4.68-14.1	100-90-80	10
Triaminoguanidine Nitrate, $CH_9N_7O_3$	3.30-3.09-3.78	100-80-60	10
1,2,4-Triazole, $C_2H_3N_3$	3.92-4.33-3.74	100-65-65	10
1,3,5-Trinitrobenzene, $C_6H_3N_3O_6$	3.88-3.62-3.61	100-25-20	10
2,4,6-Trinitro-Cyclo-Trimethylenetriamine, $C_3H_6N_6O_6$	3.04-6.75-5.10	100-80-80	10
2,4,6-Trinitrotoluene, $C_7H_5N_3O_6$	3.84-6.99-4.26	100-80-80	10
TNT, $C_7H_5N_3O_6$	5.01-2.68-3.88	100-70-65	6; 10 11a; 13
Trinitrotoluene anthracene, $C_{21}H_{15}N_3O_6$	8.76-7.08-4.56	100-35-35	10
Trinitrotoluene-2,4-dinitroanisole, $C_{21}H_{15}N_3O_6$	3.88-7.08-3.94	100-70-55	10
Trinitrotoluene-2,4-dinitromesitylene, $C_{15}H_{15}N_5O_{10}$	3.91-7.14-6.56	100-95-70	10
Trinitrotoluene-2-iodo-3-nitrotoluene, $C_{14}H_{11}IN_4O_8$	6.42-3.63-3.51	100-50-45	10
Trinitronaphthalene, $C_{17}H_{13}N_3O_6$	6.66-3.35-7.66	100-65-55	10
Trinitrotoluene phenanthrene, $C_{21}H_{15}N_3O_6$	7.14-7.90-3.40	100-55-25	10
Trioxane, $C_3H_6O_3$	4.72-3.71-2.34	100-100-60	10
Triphenyl aluminum, $C_{18}H_{15}Al$	4.91-4.40-3.91	100-100-100	10
Urea nitrate, $CH_4N_2O.HNO_3$	3.10-4.12-3.42	100-40-40	10

Footnote to Table 2:

a - Relative intensity terms:

VVS - very, very strong

VS - very strong

S - strong

M - medium

F - faint

Table 3
X-Ray Crystallographic Data of Various Energetic Materials (Refs 7, 15a & 20)

Designation	System	Space Group	a	b	c	Moles per unit cell
Ammonium Nitrate:						
ϵ or I	cubic	—	4.40	—	—	1
δ or II	tetragonal	—	5.75	—	5.00	2
γ or III	orthorhombic	V_h^{16}	7.06	7.66	5.80	4
β or IV	orthorhombic	V_h^{13}	5.75	5.45	4.96	2
α or V	rhombic	V_h^{13}	4.928	5.434	5.732	2
Ammonium Perchlorate:						
	rhombic	V_h^{16}	9.202	5.816	7.447	4
	—	—	9.13	5.17	7.47	4
	—	D_{2h}^{16}	9.231	5.813	7.453	4
Nitrocellulose (12.6% N):						
	monoclinic	—	13.9	25.6	9.0	—
			(axial angle $\beta = 90^\circ$)			
Potassium Nitrate:						
	hexagonal	C_3^5V	4.365	—	—	1
			(axial angle $\alpha = 76^\circ 56'$)			
Triaminoguanidinium Nitrate:						
	orthorhombic	P_{bcm}	8.389 (7Å)	12.684 (8Å)	6.543 (5Å)	—
RDX (Cyclotrimethylene Trinitramine):						
	orthorhombic	—	13.22	11.61	10.72	—

diffraction pattern are entered for each compd or phase in terms of $d(\text{Å})$ together with their respective relative intensities. Examples of single crystal technique information is presented in Table 3

The complexity and volume of available diffraction data requires that other than manual techniques be used to match unknown to known spectra. Available computer programs have indeed simplified the problem of identifying an unknown substance (Refs 9, 15, 16, 21 & 22). The work of Abel and Kemmey (Ref 16) in this area is worthy of note. Data taken from this report is presented as Table 4. The authors use values of $2\theta (<90^\circ)$ to identify phase location instead of values of d in Å. Major computer programs of this type endeavor to identify the crystal structure of an unknown and cite a general factor of certainty to support the credibility of the analysis interpretation

Written by H.L. Herman

Table 4
 Tabulated Computer Files of X-Ray Diffraction Data of Energetic Materials (from Ref 16)

Compound	Diffraction Spacing in 2θ Degrees	Intensity in Percent
Ammonium Nitrate, NH_4NO_3	28.5-32.5-22.0-18.0-39.5	100-100-62.5-60-32.0-30
Ammonium Perchlorate, NH_4ClO_4	19.0-24.0-22.0-22.3-29.8	100-61-42.5-44-43
DATB, Diaminotrinitrobenzene, $\text{C}_6\text{H}_3\text{N}_5\text{O}_6$	25.0-30.0-20.0-22.6-12.0-16.0	100-87-45-38-30-30
EDNA, Ethylene Dinitroamine, $\text{C}_2\text{H}_6\text{N}_4\text{O}_4$	26.0-28.5-16.0-19.0-30.0	100-100-70-70-70
Hexanitroso benzene, $\text{C}_6\text{N}_6\text{O}_6$	23.0-19.0-26.0-29.0-13.3	100-80-70-60-33
α -HMX, $\text{C}_4\text{H}_8\text{N}_8\text{O}_8$	25.0-23.5-14.5-29.5	100-77.5-30-20
β -HMX, $\text{C}_4\text{H}_8\text{N}_8\text{O}_8$	20.0-31.5-22.5-14.5-15.5	100-76-55-35-35
γ -HMX, $\text{C}_4\text{H}_8\text{N}_8\text{O}_8$	13.5-16.5-14.0-23.0-23.5	100-80-60-40-35
Δ -HMX, $\text{C}_4\text{H}_8\text{N}_4\text{O}_8$	24.0-13.0-16.0-17.0-15.5	100-96-87-83-61
α -Lead azide, PbN_6	18.0-21.0-31.5-28.5-23.0	100-75-67-45-37
β -Lead azide, PbN_6	30.5-22.0-17.5-20.0-36.5	100-80-70-70-60
γ -Lead azide, PbN_6	18.0-20.0-23.0-25.5-27.0	100-100-100-100-100
Δ -Lead azide, PbN_6	17.0-18.0-20.0-29.5-22.5	100-100-100-100-50
(Basic) Lead azide, PbN_6	29.0-33.0-47.0-12.0	100-40-45-20
(Normal) Lead Styphnate, $\text{C}_6\text{H}_3\text{N}_3\text{O}_9\text{Pb}$	11.0-30.0-20.0-22.0-24.8	100-90-80-80-80
MANA, Monomethylammonium Nitrate, $\text{CH}_6\text{N}_2\text{O}_3$	21.5-40.0-25.0-38.5-38.6	100-55-50-25-15
Nitroguanidine, $\text{CH}_4\text{N}_4\text{O}_2$	17.0-21.0-37.5-24.5-33.5-44.5	100-82-70-65-65-50
PA, Picric acid, $\text{C}_6\text{H}_3\text{N}_3\text{O}_7$	23.5-22.5-28.0-22.5-8.8	100-70-50-50-40
PETN, $\text{C}_5\text{H}_8\text{N}_4\text{O}_9$	23.0-25.0-26.5-28.0-34.0	100-80-60-60-60
RDX, $\text{C}_3\text{H}_6\text{N}_6\text{O}_6$	17.5-29.0-17.0-13.0-17.0	90-100-100-67.5-67
Silver azide, AgN_6	37.0-21.5-44.0-30.0-31.5	100-80-80-60-50
TATB, Triaminotrinitrobenzene, $\text{C}_6\text{H}_3\text{N}_6\text{O}_6$	28.0-20.5-20.6-42.0-42.5	100-15-15-13-11
Tetracene, $\text{C}_2\text{H}_8\text{N}_{10}\text{O}$	27.5-15.5-18.0-18.2-11.7	100-40-35-35-34
Tetryl, $\text{C}_7\text{H}_5\text{N}_5\text{O}_8$	12.0-6.0-23.0-18.5-24.5	100-75-45-37-36
TNB, $\text{C}_6\text{H}_3\text{N}_3\text{O}_6$	22.5-24.0-22.6-23.8-16.5	100-37-33-27-24
TNT, $\text{C}_7\text{H}_5\text{N}_3\text{O}_6$	17.0-33.0-22.5-28.5-26.0	100-70-65-25-20
TNX, 1,3-Dimethyl-2,4,6-Trinitrobenzene, $\text{C}_8\text{H}_7\text{N}_3\text{O}_6$	11.0-21.5-23.8-24.5-29.0	100-95.0-85-75-59

Glossary of X-Ray Diffraction Terms

a - interatomic distance in Å or the dimensions of a unit cubic cell

crystal symmetry - (these symmetry elements are taken from Ref 4, pp 79-82): "... If a well-formed crystal is examined it is seen to be a regular solid (in the geometrical sense of the term 'regular'), and as such is an essentially symmetrical object. If crystals of different materials are examined it is observed that they often possess different kinds of symmetry. It is, therefore, necessary to recognise and describe the different types, and the description is in terms of 'symmetry elements'. Any one symmetry element has associated with it a 'symmetry operation' the application of which leaves the external appearance of the crystal unaltered. The possible symmetry elements are:

1. **Axes of SYMMETRY.** An axis of symmetry is a line such that rotation of the crystal about this line through an angle $360^\circ/n$ put the crystal into a position which is indistinguishable from its original position. The value of ' n ' is the 'degree' of the axis and can only be 1, 2, 3, 4, or 6, no other values being possible. The value 1 is in a sense trivial being an identity axis and any crystal has an infinite number of such axes. Simple examples of other degrees of axis of symmetry are:

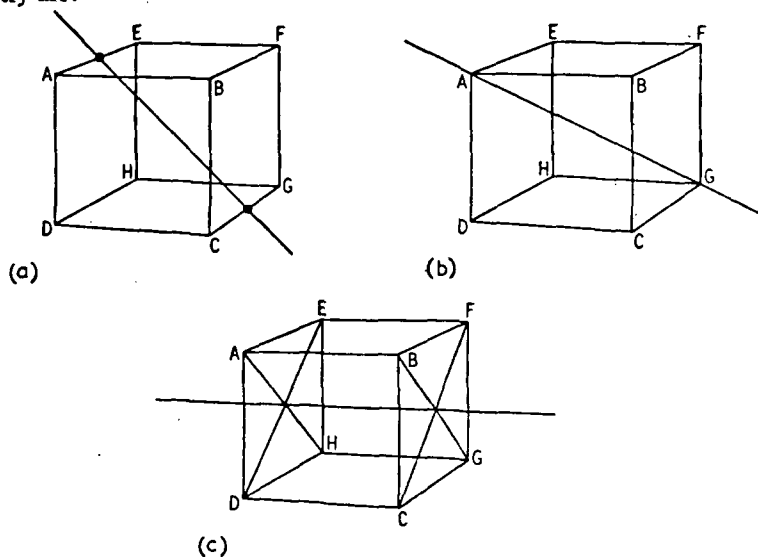

Fig 5.1 Axes of symmetry in a cube: (a) a line through the midpoints of AE and CG is diad axis: (b) the line AG is a triad axis: (c) a line through the midpoints of ADHE and BCGF is a tetrad axis

(a) *Two fold or diad axis*—the line joining the mid-points of diagonally opposite edges of a cube (Fig. 5.1 (a)).

(b) *Three fold or triad axis*—the line joining diagonally opposite faces of a cube (Fig. 5.1(b)).

(c) *Four fold or tetrad axis*—the line joining the mid-points of opposite faces of a cube (Fig. 5.1(c)).

(d) *Six fold or hexad axis*—the axis of a right prism having as base a regular hexagon (Fig.5.2).

2. **PLANES OF SYMMETRY.** The plane of symmetry is reflection in the plane. Planes of symmetry are often called mirror planes or reflection planes. Some examples of planes of symmetry are shown in Fig. 5.3. Note that it is not sufficient for the two halves of the body to be identical. They must be exact mirror images of one another in the plane. Fig. 5.4 illustrates a plane dividing a body into two identical halves which are not mirror images of one another in the plane so that the plane is not a plane of symmetry.

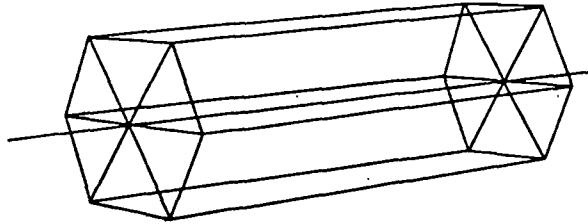

Fig 5.2 A hexad axis in a hexagonal prism

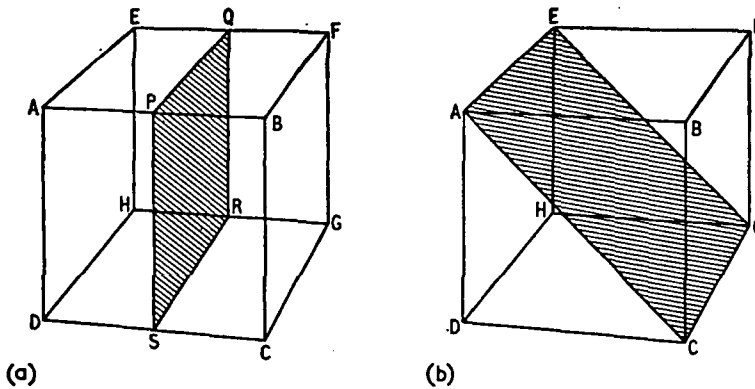

Fig 5.3 Planes of symmetry: (a) PQRS is a plane of symmetry if ABCDEFGH is a cube or a rectangular parallelepiped: (b) ACEG is a plane of symmetry only if ABCDEFGH is a cube (see Fig 5.4)

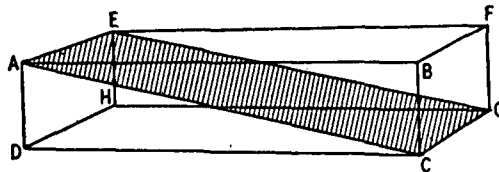

Fig 5.4 A plane dividing a body into two identical halves may not be a plane of symmetry

3. **CENTRES OF SYMMETRY.** If a body has a centre of symmetry then if any straight line is drawn through the centre, the centre is equidistant, measured along the line, from the bounding faces of the body. The symmetry operation for this symmetry element is known as 'inversion'. To invert a point about the centre of symmetry proceed along a straight line from the point to the centre and continue along the same line an equal distance beyond the centre.

4. **INVERSION AXES.** The symmetry operation for an n -fold inversion axis is rotation through an angle of $360^\circ/n$ followed by inversion through a centre on the axis. It can be demonstrated that only an inverse tetrad axis represents any new idea and that the others can be regarded as combinations of the symmetry elements already described. Thus, if an inverse n fold axis is represented by the symbol \bar{n} and an n fold axis by n , it can be shown that:

$\bar{1}$ is equivalent to a centre of symmetry
 $\bar{2}$ is equivalent to a plane of symmetry perpendicular to $\bar{2}$
 $\bar{3}$ is equivalent to 3 plus a centre of symmetry on the axis
 $\bar{6}$ is equivalent to 3 plus a plane of symmetry perpendicular to the axis.

The symmetry elements indicated above can be used to describe the external symmetry of crystals. More elements have been described than are actually necessary for the description of all cases. Thus the centre of symmetry is now no longer used as a fundamental element and the inversion axes are used instead . . ."

d - interplanar distance in Å

lattice - a network of points used to define the geometry of a crystal

planar indexes - By convention, the indexes of a plane are given the general symbols h, k, l , and for a cubic unit cell it can be shown that

$$d_{hkl} = a/\sqrt{h^2 + k^2 + l^2}$$

where d is the interplanar distance determined from X-ray diffraction studies and a is the distance between the atoms. In this case, a represents the dimensions of the unit cubic cell; h, k , and l are small integers, so the ratio of d values should be $1:1/\sqrt{2}:1/\sqrt{3}:1/\sqrt{4}:1/\sqrt{5}$ etc. With complex cubic systems, eg, face centered cubic, there are gaps in the series
point groups - the 32 crystal classes derived from the various elements of symmetry found in a well-formed crystal. These groups are arranged into seven *crystal systems* shown under *unit cell* below

space group - The space arrangement of symmetry elements associated with each point of a space lattice. There are 230 such space groups

unit cell - The basic unit of a crystal system or lattice from whose repetition the entire crystal can be constructed, and whose geometry is defined as follows:

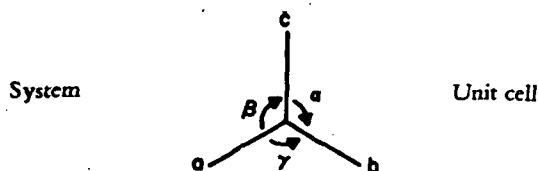

Cubic	$\alpha=\beta=\gamma=90^\circ$; $a=b=c$
Tetragonal	$\alpha=\beta=\gamma=90^\circ$; $a=b, c$ unequal
Trigonal and hexagonal	(i) $\alpha=\beta=90^\circ, \gamma=120^\circ$; $a=b, c$ unequal (ii) $\alpha=\beta=\gamma\neq 90^\circ$; $a=b=c$
Orthorhombic	$\alpha=\beta=\gamma=90^\circ$; a, b, c unequal
Monoclinic	$\alpha=\beta=90^\circ, \gamma\neq 90^\circ$; a, b, c unequal
Triclinic	α, β, γ ; a, b, c all unequal

The type of equations which have to be solved in order to determine cell dimensions for cell types other than the cubic system can be indicated by taking just three examples.

In tetragonal systems

$$d_{hkl} = 1/\sqrt{(h^2 + k^2)/a^2 + l^2/c^2}$$

For a hexagonal unit cell

$$d_{hkl} = 1/\sqrt{4(h^2 + hk + k^2)/3a^2 + l^2/c^2}$$

When extended to rhombohedral systems, the mathematical equation is

$$d_{hkl} = a/\sqrt{(1 + 2\cos^3\alpha - 3\cos^2\alpha) / \sqrt{(h^2+k^2+l^2)\sin^2\alpha + 2(hk+kl+lh)(\cos^2\alpha - \cos\alpha)}}$$

Refs: 1) A.M. Soldate & R.M. Noyes, "X-Ray Diffraction Patterns for the Identification of Crystalline Constituents of Explosives", *Anal Chem* **19**, 442-44 (1947) & *CA* **41**, 6105 (1947)
 2) P.J. Blatz et al, "Research in Nitropolymers and their Application to Solid Smokeless Propellants", **QR712**, Aerojet-General, Azusa, Contract N7onr-462, Task Order I and NOas 53-618-C (1953), 37 3) L.V. Azaroff & M.J. Buerger, "The Powder Method in X-Ray Crystallography", McGraw-Hill, NY (1958) 4) J.V. Smith et al, Eds, "Index to the X-Ray Powder Data File (1962)", ASTM STP48-L (1962) 5) Anon, "International Tables for X-Ray Crystallography", Vol 1, Kynoch Press, Birmingham, Engl (1962) 6) H.E. Swanson et al, "Standard X-Ray Diffraction Powder Patterns", NBS Monograph **25-Section 7**, Dept of Commerce, Washington, DC (1962) 7) Anon, "Military Pyrotechnics . . . Properties . . .", **AMCP 706-187** (1963) 8) J.G. Brown, "X-Rays and their Applications", Plenum Press, NY (1966) 9) D.K. Smith, "A Fortran Program for Calculating X-Ray Powder Diffraction Patterns", **UCRL-50264**, Lawrence Radiation Lab, Livermore (1967) 10) J.V. Smith et al, Eds, "Index (Organic) to the Powder Diffraction File-1967", ASTM PD1S-170, ASTM,

Phila (1967) 11) G. Gandolfi, *Mineral Petrog Actc* **13**, 67-74 (1970) & CA, not found
 11a) W. Connick et al, "Polymorphism in 2,4,6-Trinitrotoluene", *AustralianJChem*, Vol **22**, 2685-88 (1969) (AD-703111) 12) C. Ribauda et al, "The Effects of Reactor Irradiation on the Chemical Characteristics of Solid Explosives", *PATR* **3893**(1970) 13) Anon, "Explosives", *Encycl Ind Chem Anal*, Vol **12** (1971), 405, 417 & 418 14) W.F. Pickering, "Modern Analytical Chemistry", Dekker, NY (1971), 288-94
 15) C.M. Clark et al, "Program for Calculating X-Ray Powder Diffraction Patterns - Version 5", Penn State Univ, Univ Park (1973) 15a) I.T. McDermott & P.P. Phakey, "An X-Ray Topographic Study of Defect Structures in Cyclo-trimethylene Trinitramine", *PhysicaStatus-Solids Appl Res*, Vol **8**, 505-11 (1971) 16) J.E. Abel & P.J. Kemmey, "Identification of Explosives by X-Ray Diffraction", *PATR* **4766** (1975)
 17) S.I. Morrow et al, "Investigation of Propellant and Explosive Solid Solution Systems—11 X-Ray Studies", *ARLCD-TR-77066* (1978)
 18) G.C. Vezzoli & J. Abel, "A New High-Pressure Form of Sulfur Derived from the Decomposition of S_4N_4 ", *Science* **200**, 765-66 (1978) & CA **89**, 27012 (1978) 19) D.V. Canfield et al, "The Use of the Gandolfi Camera as a Screening and Confirmation Tool in the Analysis of Explosive Residues", *JForensicSci* **22** (2), 337-47 (1977) & CA **88**, 69905 (1978)
 20) A.J. Bracuti, "The Crystal Structure Determination of Triaminoguanidinium Nitrate . . .", *ARLCD-TR-78050* (1979) 21) W.F. McClune et al, Eds, "Powder Diffraction File-Alphabetical Index Inorganic Materials 1979", *SMA-29*, JCPDS, Intl Centre for Diffraction Data, Swarthmore (1979) 22) Ibid, "Powder Diffraction File-Organic Materials Search Manual, Hanawalt-Alphabetical-Formulae 1979", *SMO-29*, Ibid

X-Staff (Tetan, Tetranitromethan). Ger designation for Tetranitromethane (see Vol 8, M83-L to M85-R)

As the classical method of prepg X-Staff from acetic anhydride and nitric acid was considered very expensive, a new method was developed in Ger during WWII by a Dr Schimmelschmidt. The procedure developed is essentially

the reaction between acetylene and nitric acid to give Nitroform (Trinitromethane), and the heating of a mixt of Nitroform and nitric acid with sulfuric acid to yield X-Staff. This colorless liq, $C(NO_2)_4$, has a freezing pt of -14°

The first X-Staff expl mixt used consisted of very finely pulverized Al powder (called Pyroschliff), X-Staff, a hydrocarbon rich in hydrogen, and a highly dispersed silica (called K_3 -Staff) as a consolidating agent. This solid compn possesses a very high blast effect and a comparatively low detonation velocity. It was used as a bursting charge in underwater ammo. Other composite expls consisted of X-Staff with liq or pulverized carbon contg materials such as hydrocarbons, coal, charcoal and nitrocompds. Some of these mixts are more powerful and brisant than TNT, PA, PETN or RDX. One of the most powerful and brisant expls known is a mixt of X-Staff and toluene, which has a detonation velocity of about 9300 m/sec

Ref: Anon, "Handbook of Foreign Explosives", *FSTC381-5042*, US Army Foreign Science & Technology Center, Washington (1965), 187 & 295

XTX-8003 (eXTrudable eXplosive). Los Alamos National Scientific Laboratory (LASL) designation for an extrudable expl contg PETN (80 wt%; 69.9 vol %) coated with a low-temp vulcanizing silicone resin, Sylgard 182 (20 wt %; 30.1 vol %); atomic compn $C_{1.80}H_{3.64}N_{1.01}O_{3.31}Si_{0.27}$; white putty curable to rubbery solid; d, TMD 1.556g/cc, nominal 1.50-1.53g/cc; mp 129-135°. XTX-8003 is used in special applications that require expls with small detonation failure diameters

Manufacture. Sylgard 182 resin and its curing agent are mixed with PETN in a high-shear vertical mixer to the consistency of wet sea sand. The material is passed through a three-roll differential paint mill until it has the consistency of glazier's putty. After milling, XTX-8003 has a shelf life of 24 hrs at 25° . Storage at -30° increased the shelf life to 8 months. When it is to be used, the XTX-8003 is extruded into molds of the desired configuration. Curing or polymerization is achieved by exposure to 65° for 8 to 12 hrs

Chemical Properties (Ref 2):

ΔH_{det} (kcal/g):	$H_2O_{(l)}$	$H_2O_{(g)}$
calc:	1.88	1.69
exptl:	1.16	1.05
ΔH_f (kcal/mole):	-39	-

Detonation Properties:

Deton vel (mm/ μ sec): 7.30 at d 1.53g/cc (Ref 2). Charge radius affects the deton vel at a d of 1.53g/cc, confined in a polycarbonate plastic in a hemicylinder configuration, as follows:

$$D(R) = 7.260 [(1 - 0.191 \times 10^{-2}/R) - 2.12 \times 10^{-4}/R (R - 0.111)]$$

where D = deton vel in mm/ μ sec, and R = charge radius in mm. The exptly detd failure diam is 0.36mm (Ref 1)

P_{cj} (kbar): meas 170, calcd 210 at d 1.546g/cc (Ref 2)

Energy (cylinder test, mm/ μ sec²/2): 6mm, 0.710; 19mm, 0.950 at d 1.554g/cc (Ref 2)

Thermal Properties:

Thermal conductivity (cal/cm-sec- $^{\circ}$ C): 3.42×10^{-4} (Ref 2)

Heat capacity at const pressure (cal/g - $^{\circ}$ C): $0.252 + 8.5 \times 10^{-4}T$ at d 1.50g/cc in temp range 37 $^{\circ}$ to 127 $^{\circ}$ (Ref 1)

Coeff of thermal expansion (1/ $^{\circ}$ C): 1.65×10^{-6} at d 1.50g/cc in temp range -50 $^{\circ}$ to 25 $^{\circ}$ (Ref 1)

Thermal stability: 0.25g sample at 100 $^{\circ}$ for 22 hrs, >0.02cc gas evolved (Ref 2); vac stab at 100 $^{\circ}$ for 48 hrs, 0.2ml/g of gas evolved (Ref 1)

DTA and pyrolysis: see Fig 1 (from Ref 1)

Tensile Strength and Modulus (Ref 1):

Ultimate tensile strength (psi) at 22 $^{\circ}$ and d 1.50g/cc: 90 \pm 20

Tensile modulus (psi $\times 10^{-5}$): strain-to-failure of a 0.25" diam charge tested at a load rate of 0.05/min occurs after 5% elongation

Sensitivity:

Drop wt sensitivity (m):

	12 tool	12B tool
5 kg, cured:	0.21	-
5 kg uncured:	0.25	-
2.5 kg:	0.31	0.42 (Ref 2)
cured or uncured (H_{50} , cm)	30	35 (Ref 1)

Susan test: Threshold velocity approx 160ft/sec; has very small probability of buildup to violent reaction (Ref 2)

Projectile impact vel (ft/sec) 160 750

Relative energy release (%) < 1 ~ 5 to 8 (Ref 1)

Gap test (mils at d 1.53g/cc):

LANL-SSGT: cured, 130-160

LANL-SSGT: uncured, 160-190 (Ref 2)

at d 1.50g/cc, SSGT, G_{50} mm = 4.42,

L_{95} mm = 0.28 (Ref 1)

Shock Initiation Properties (Ref 1):

Wedge test results:

Density (g/cc)	Distance, x^* , and Time, t^* , to Detonation (mm and μ s)	Pressure Range (GPa)
1.53	$\log P = (0.74 \pm 0.01) - (0.37 \pm 0.02) \log x^*$	$2.5 < P < 8.2$

where P = pressure in gigapascals

Shock Hugoniot:

Density (g/cc)	Shock Hugoniot (mm/ μ s)	Particle Velocity (mm/ μ s)
1.50	$U_s = 1.49 + 3.03 U_p$	$0 < U_p < 0.8$
1.53	$U_s = (1.59 \pm 0.39) + (3.24 \pm 0.63) U_p$	$0.48 < U_p < 0.78$

Refs: 1) T.R. Gibbs & A. Popolato, "LASL Explosive Property Data", Univ of California, Berkeley (1980), 188-95 2) D.M. Dobratz,

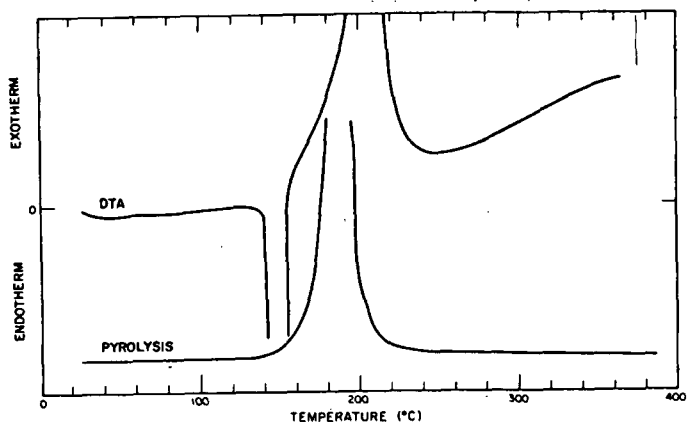

Fig 1 XTX-8003 DTA and Pyrolysis Test Results

"LLNL Explosives Handbook - Properties of Chemical Explosives and Explosive Simulants", UCRL 52997, Lawrence Livermore Lab, Livermore, Ca (1981), 19-147

XTX-8004. Los Alamos National Scientific Laboratory (LASL) designation for an extrudable expl contg RDX (80wt %; 69.9 vol %) coated with a low-temp vulcanizing silicone resin, Sylgard 182 (20wt %; 30.1 vol %); atomic compn $C_{1.62}H_{3.78}N_{2.16}O_{2.43}Si_{0.27}$; white putty curable to rubbery solid; d, TMD 1.579g/cc, nominal 1.55g/cc; mp 200° decompn; hardness S55. XTX-8004 is used in special applications that require more thermal stability than XTX-8003 (see above) can give. The detonation failure diameter is slightly greater than that of XTX-8003

Manufacture. Same as XTX-8003

Chemical Properties (Ref 2):

$$\Delta H_{det}(\text{kcal/g}): \begin{array}{l} \text{H}_2\text{O(l)} \\ \text{calc: } 1.87 \end{array} \quad \begin{array}{l} \text{H}_2\text{O(g)} \\ 1.67 \end{array}$$

$$\Delta H_f(\text{kcal/mole}): -1.42 \quad -$$

Solubility: sol in acet, DMFA, DMSO, N-methylpyrrolidone; sl sol in ethanol, pyridine, insol in benz, carbon disulfide, carbon tetrachloride, chl_f, ethyl acetate, ethyl-eth & w

Detonation Properties: Charge radius affects the detonation velocity of 1.5g/cc XTX-8004 confined in polycarbonate plastic in a hemispherical configuration as follows (Ref 1):

Diameter (mm)	Detonation Velocity (mm/μs)
∞	7.45
4.5	7.35
3.13	7.30
2.0	7.22
1.75	7.15
1.6	Failure

Deton vel (mm/μsec): 7.22 at d 1.55g/cc (Ref 2)

Thermal Properties:

Thermal conductivity (cal/cm-sec -°C):
3.42 x 10⁻⁴ at 313°K (Ref 2)

3.4 x 10⁻⁴ (Ref 1)

Coeff of thermal expansion:
α(linear): 231 μm/m-°K (Ref 2)

Thermal stability: 0.25g sample at 120° for 22 hrs, approx 0.06cc gas evolved (Ref 2); vac stab at 120° for 48 hrs, 0.1-0.3ml/g of gas evolved (Ref 1)

Heat capacity at const pressure (cal/g -°C):
0.247 + 6.2 x 10⁻⁴ at d 1.50g/cc in temp range 25° to 187°

DTA and pyrolysis: see Fig 1 (from Ref 1)

Sensitivity: Drop wt sensitivity (m):

	12 tool	12B tool
2.5kg	0.65-0.70	1.45-1.70

(Ref 2)

H ₅₀ , cm, cured	70	170
uncured	65	145

Gap test (mils at d 1.58g/cc):

LANL-SSGT: 1.96 (Ref 2)

at d 1.52g/cc, SSGT, G₅₀mm = 1.96 (Ref 1)

Refs: 1) T.R. Gibbs & A. Popolato, "LASL Explosive Property Data", Univ of California, Berkeley (1980), 196-201 2) D.M. Dobratz, "LLNL Explosives Handbook - Properties of Chemical Explosives and Explosive Simulants", UCRL 52997, Lawrence Livermore Lab, Livermore, Ca (1981), 19-149

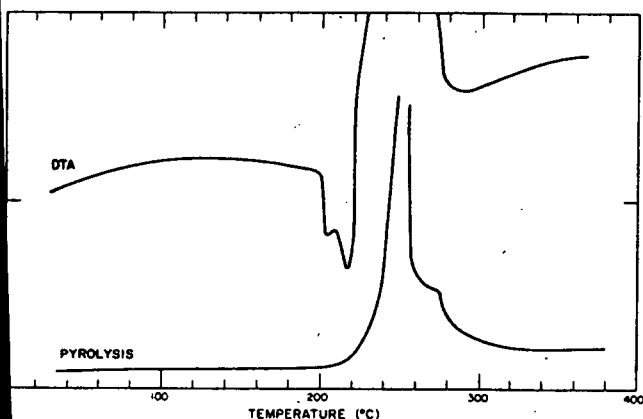

Fig 1. XTX-8004 DTA and pyrolysis test results

Xylan Dinitrate (β-D - Pyranoglucose dinitrate). (C₅H₆N₂O₈)_x; mw (218.58)_x; N10.99%; OB to CO₂ - 29.28%; white powd. Insol in ethanol-eth. Prepn is by reacting pure xylan with mixed acid (nitric acid/sulfuric acid/w in 21.10/66.85/8.05% proportions) at from 0 to 10°. The product is pptd from w

Accdy to Ref 2 the TNT equivalency of the

dinitrate is 107

Refs: 1) Beil, not found 2) L.C. Smith & E.H. Eyster, OSRD 5746 (1945), 19
3) Urbanski 2 (1965), 229 & 414

Xylene and Derivatives

See under "Dimethylbenzene and Derivatives" in Vol 5, D1321-L to D1325-L, and the following Addnl Refs:

Xylene Isomers.

1) H. Miyama, "Ignition of Aromatic Hydrocarbon-Oxygen Mixtures by Shock Waves", JPhysChem 75 (10), 1501-04 (1971) & CA75, 8084 (1971) [The author measured the induction period, τ , for the combstn of the xylenes using a shock-tube technique. He obtained the following linear relationship between $\log \tau(O_2)$ and $1/T$, where T is the temp in $^{\circ}K$ behind the reflected shock wave, τ is in seconds and (O_2) is in moles/l:

Isomer	Equation
o-xylene	$\log \tau(O_2) = (8920 \pm 310) / [T - (6.24 \pm 0.24)]$
m-xylene	$\log \tau(O_2) = (8420 \pm 310) / [T - (5.98 \pm 0.23)]$
p-xylene	$\log \tau(O_2) = (6840 \pm 240) / [T - (5.33 \pm 0.17)]$

2) B.I. Shraer, "Explosive Properties of p-Xylene and Acetic Acid", KhimProm (Moscow) 46 (7), 747-50 (1970) & CA74, 33200 (1971) [The author reports that at 160° the lower concn limits for explosiveness of p-xylene in air is 1 vol % at pressures of from 1 to 5 atms. The upper limit increases from 12 to 17 vol % when the pressure is increased from 1 to 5 atms. At 160° and 1 atm, p-xylene- O_2 mixts are expl at p-xylene concns of from 0.6 to 39%. Air in which the O_2 content has been lowered below 5% does not produce expl mixts with p-xylene at any concns. Also, the addn of w vapor to p-xylene-air mixts reduces the range of explosiveness, and the presence of 50% w in p-xylene-w mixts completely suppresses explns in such mixts at 160° and 16 atms]

3) S. Hulanicki & K. Slawomir, "Temperature of Self-Ignition of Benzene and its Derivatives", OchrPrzeciwpozarowaPrzemChem (4), 1-6 (1972) (Pol) & CA79, 7561 (1973) [Using the ASTM method of measurement these authors found the max safe (below self-ign) temp of o- and p-xylenes to be 451° and 477° , resp]

4) R. Yokogawa et al, "Highly Explosive Nitroglycerin Explosives", JapP 71-40160 (1971)

& CA77, 22454 (1972) [Claimed are expls with better deton properties than AN-fuel oil expls. The invented expls consist of mixts of xylene (as the fuel) and nonylphenyl ether (as the surfacant) together with NG and prilled AN (as the expl sensitizers and oxidizing agents)]

5) N.L. Nunjal et al, "Ignition of Nonhypergolic Rocket Fuels with Fuming Nitric Acid under Suitable Conditions", AIAAJ10 (10), 1345-46 (1972) & CA78, 32210 (1973) [In experimentation designed, in part, to measure the total time (or active life) during which a freshly prepd mixt of K permanganate-RFNA is capable of igniting a nonhypergolic rocket fuel, the authors found that a 5% concn of K permanganate in RFNA will ignite xylene for 73 secs (the longest measured) as compared with the active life for furfural, which was found to be 29 secs (the shortest). The authors concluded that with suitable catalysts, such as K permanganate, an acid mixt can be produced with a sufficiently active life span to make nonhypergolic bipropellants (especially a fuel such as xylene) hypergolic]

Xylene Derivatives

1, 4-Dimethyldiazidobenzene (p-Xylyldiazide) $(N_3CH_2) \cdot C_6H_4 \cdot (CH_2N_3)$, $C_8H_8N_6$; mw 188.22; N44.66%; OB to CO_2 -170.01%; cryst; mp 29° ; bp $175-90^{\circ}$. Prepn is by reacting p-xylyl chloride with Na azide

The diazide is not detonated by a 2g ball dropping 25cm, and puffs off above 190°
Ref: Blatt, OSRD 2014 (1944)

Mononitroxylenes.

1) P.C. Condit & R.L. Haynor, "Thermal Decomposition of Nitroxylene . . .", I & EC 44 (8), 1700-04 (1949) & CA43, 9045 (1949) [Reported is the effect of various hydrogenation contaminants and environments on the expln temp of a nitroxylene. It was obtained by distln of a commercial sample of mixed xylenes of petr origin; nitrogroups 30.0 to 30.4%; bp $79-92^{\circ}$ at 2 mm; sp grav 1.030 at 23° , RI 1.5443 at 20° . The min expl decompn temp was found to be about 308° , and is substantially independent of the pressure of the gas surrounding the sample, being the same in H_2 or methane. It is unaffected

by the presence of various steels or active C. The decompn temp is lowered slightly by the presence of 5-15% dinito compds. Prolonged heating of nitroxylyene at temps below the decompn temp causes it to resinify. Heating the aromatic nitro compds with small quantities of the corresponding amines lowers the decompn temp by as much as 7°, but amine quantities above 25% were found to prevent expl decompn (giving resinous masses instead). The expl decompn temp is lowered markedly to 249°, however, by the presence of H₂ and MoS on active C. The authors conclude that this is the effect of the initiating reaction of the exothermic hydrogenation of the nitroxylyene]

Dinitroxylenes.

1) J.K. Hubbard, "Nitrated p-Xylene Polymers", USP 2726217 (1955) & CA50, 5292 (1956) [The inventor claims an expl compd which has a partial decompn temp of 220°, and an expl ign pt of 282°. It is sol in cyclohexanone. Prepn is affected by the portion-wise addn of 5g of 20 mesh p-xylene polymer to 200cc of 90% fuming nitric acid so that the temp does not exceed 45-50°. Soln is said to occur in one hr, with stirring required for an addnl three hrs. The soln is then filtered and the filtrate drowned in ice-w. The resulting ppt is then w-washed and vac-dried at 70° to give the dinitrate. It is claimed to be a HE comparable to TNT with a friction sensy similar to that of RDX. It forms a brittle film from a 10% cyclohexanone soln]

Dinitroxylyene Nitrate. (DNXDN) C₆H₂(CH₂NO₃)₂ · (NO₂)₂, C₈H₆N₄O₁₀; mw 318.18; N 17.61%; OB to CO₂ -45.26%; stable white cryst. Prepn is by 1) chlorinating p-xylene in the sunlight at 100°, then cooling and filtering the dichloro derivative; 2) nitrating the dichloro derivative with mixed acid to the dinitro derivative; then 3) heating the nitrated derivative with pure w under a pressure of 20lbs/sq inch to replace the Cl with OH radicals, then evapg the aq soln to obtain dinitrodimethylol benz, and 4) further nitrating this product to obtain the desired deriv. Stine claims that the compd is a powerful expl which can be used in blasting caps or priming charges; eg, DNXON (80)/MF (20%)

Refs: 1) C.M. Stine, "Nitro Compounds for Use

in Explosives", USP1309551 (1919) & CA13, 2282 (1919) 2) Ibid, "Blasting Cap or Priming Charge for Explosives", USP1309552 (1919) & CA13, 2283 (1919)

Trinitroxylenes

Analysis

Ya.I. Leltman, "A Method for the Analysis of Technical Trinitroxylyene (Xylyl)", Trudy LKKhTi, No7, 127-41 (1939); Khim Referat Zhur 2 (5), 66-7 (1939) & CA34, 2604 (1940) [To ascertain the individual percentages of trinitro-m-xylene and trinitro-p-xylene in a mixt contg these two compds, the temp at the start of crystn of the mixt and the eutectic temp of the mixt are measured. The individual % of each compd can then be detd from a binary fusion diagram of these compds]

Preparation

M. Warman, "Preparation of Trinitro-Meta-Xylene (TNX)", PATM 1728 (1966) [Reported is a procedure for the pilot plant prepn of TNX from m-xylene. The nitration of m-xylene is carried out in two stages: 1) The conversion of m-xylene to 2-nitro-m-xylene using mixed acid (sulfuric 59/nitric 25/w 16%) at 35 to 50°, and 2) The trinitration of 2-nitro-m-xylene to trinitro-m-xylene, again using mixed acid (sulfuric 79/nitric 17.5/w 3.5%), at 95 to 102°. The author states that the overall yield of TNX from m-xylene is as high as 94%. One crystn of the crude product from acet is sufficient to raise the mp to the 182-83° value reported in the literature]

Properties

1) D.E. Schweizer, "Trinitroxylyene", Zges Schiessw Sprengstoff 14, 24-5 (1919); JSocChem Ind38, 603-04A (1919) & CA13, 3320 (1919) [Double nitration with mixed acids of tech grade xylenes produces trinitroxylenes which are reported as white crysts with a mp of 120-77°, capable of being detonated by 0.15 to 0.2g of Ag azide] 2) J. Timmermans, "... The Heat of Fusion of Organic Compounds", BulSocChemBelg44, 17-40 (1935) & CA29, 2433 (1935) [Using the fr pt curves of binary ideal soln mixts, the author detd the heat of fusion of trinitro-m-xylene as 9500cal/g-mole] 3) M. Badoche, "Determination of the Heats of Combustion of Nitro Derivatives of the Benzene

Series", BullSocChim 6, 570-79 (1939) & CA 33, 5736 (1939) [The heat of combstn of 2,4,6-trinitro-1,3-dimethylbenzene is reported as 4019.515 cal/g at const vol and at a temp of 17°] 4) K.K. Andrew & V.M. Rogozhnikov, "Inflammability of Explosives", TrMoskKhimTekhnol InstNo53, 288-300 (1967) & CA68, 41770 (1968) [A procedure involving the min wt of a primer that will ignite an expl in a manometric bomb was used to evaluate TNX among other expls. The inflammability of the expls investigated, in order of decreasing sensy, is Kpicrate, Tetryl, 62% Dynamite, TNX, AP, TNT, TNB and the Amatols. It was found that flammability increases with decreasing d of a powdered expl. Also, the required wt of primer decreases with increasing surface of the charge, within certain limits]

Note: Accdgd to unreferenced notes left by B.T. Fedoroff, some of TNX's properties are:

Ballistic Strength. 88% TNT

Brisance. 15g sand crushed vs 43g for TNT

Detonation Velocity. 3300m/sec

Expln Temp. 410°

Impact Sensitivity. 21 inches

Rifle Bullet Impact. No detonation

Stability. Stable, does not react with metals

Tetranitroxylene (2, 4, 5, 6 - Tetranitro-m-xylene).

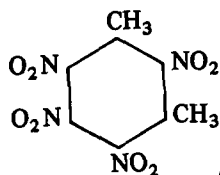

$C_8H_6N_4O_8$;
mw 286.16; N19.57%;
OB to CO_2 - 61.50%; cryst.

Accdgd to ref 2, the compd exhibits a Trauzl test value of 106% PA or 115% TNT

Refs: 1) Beil-not found 2) Blatt & Whitmore, OSRD 1085 (1942), 83 3) A.D. Little, "Punch Card. . .", Vol III, Contract DA19-020-501-ORD-(P)-57, Cambridge, Mass (1961), A93

Ethylxylenes and Derivatives. See in Vol 6, E340-L to E341-L

Xylenol, 2, 4, 6 - Trinitro-meta-5-

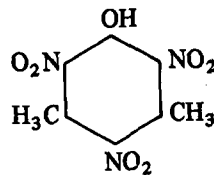

$C_8H_7N_3O_7$;
mw 257.18;
N16.34%;
OB to CO_2 -77.77%;

cryst: mp 107-08°. Prepn is by nitrosation of m-xylene, with subsequent oxidation by the addition of a liq suspension contg 20% nitrosated m-xylene to 70% nitric acid at 45 to 75°. The yield is approx 80%. Ref 3 terms this compd useful as either an expl or proplnt

Refs: 1) Beil, not found 2) F.M. Rowe et al, "Derivatives of the m-Xylenols. . .", JSocChem Ind49, 469-73T (1930) & CA25, 930 (1931) 3) D.A. Salter & R.J.J. Simkins, "Trinitrophenols", GerP 1959930 (1970) & CA73, 76860 (1970)

Xylidines. See in Vol 3, C518-R under "Copper (II) Xylidine Azide. . .", Vol 5, D1316-R to D1318-L under "Dimethyl Anilines. . ."; in Vol 6, E341-L under "Ethylxylidines and Derivatives"; plus the following addnl compds:

Xylidine Perchlorate (Dimethylaniline perchlorate). $C_8H_{12}ClNO_4$, mw 221.64, OB to CO_2 -129.9%. Two xylidine perchlorates have been prepd by neutralization of the amines with aq perchloric acid (Ref 3):

2, 4-Xylidine Perchlorate (2, 4 Dimethylaniline perchlorate).

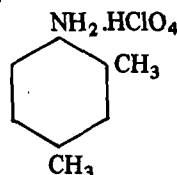

Cryst solid;
decomps at 200°;
expln temp 260°
(Refs 1 & 3)

2, 5, Xylidine Perchlorate (2, 5 Dimethylaniline perchlorate).

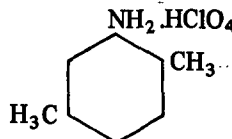

Cryst solid;
decomps at 210°;
expln temp 258°
(Refs 2 & 3)

Refs: 1) Beil 12 (483) 2) Beil 12, 488
3) R.L. Datta & N.R. Chatterjee, JCS115, 1008 (1919)

Xylite. Fr for commercial Trinitroxylene (TNX). See also in Vol 7 under "Xilite" on I182-L, and "Ksilil" on K19-L

Xylite P. Fr expl contg PA 50, TNT 40 and Xylite 10%. This compn, melting at 85°, has been used as a cast-loaded bursting charge in some projectiles

Refs: 1) Pepin Lehalleur (1935), 441
2) Anon, "Handbook of Foreign Explosives", **FSTC381-5042**, US Army Foreign Science and Technology Center, Washington (1965), 237

Xylitol. See in Vol 9, S227-R. *Addnl Ref:* L.C. Smith & E.H. Eyster, **OSRD 5746** (1945) [The TNT power equivalency of Xylitol Tetranitrate is reported as 149%]

Xylobrome. An expl, manufd in Engl between 1877 and 1879, contg nitrolognin and inorganic nitrates

Ref: Daniel (1902), 812

Xyloglodines. Expls, patented by M. Dittmar at the end of the last century, prepd by nitrating glycerin which contained some starch, cellulose, mannite and benzene

Ref: Daniel (1902), 812

Xyloidine. Name given by Braconnot to the product obtained by him in 1833 on the nitration of starch. It was Nitrostarch with a N content below 11%. See under "Nitrostarch" in Vol 8, N158-L

Xylose and its Nitrated Derivatives. See under "Sugars and their Nitrated Derivatives" in Vol 9, S232-R to S233-L

Xylyl. Russ for Trinitroxylene. See under "Ksilil" in Vol 7, K19-L

2(X,Y-Xylyl) Ethanol. $(\text{CH}_3)_2\text{C}_6\text{H}_3\text{CH}_2\text{CH}_2\text{OH}$, $\text{C}_{10}\text{H}_{14}\text{O}$; mw 150.24; OB to CO_2 -276.89%. A violent expln occurs if this compd is added to 90% hydrogen peroxide, and the mixt is then acidified with concd sulfuric acid. See also in Vol 5, D1328-R under " α, α - Dimethylbenzyl Hydroperoxide. . ."

Refs: 1) Beil, not found 2) Anon, "Fire Protection Guide on Hazardous Materials", 7th Ed, Natl Fire Protection Assn, Boston (1979), 491M-18 & 441

Xytolite. Trade name of a semigelatinous industrial expl distributed in Fr by Nobel-Bozel and the Societe Anonyme des Explosifs. Its d is 1.20g/cc and weight strength (calcd from c.u.p. value of 73) is 47%

Ref: R. Meyer, "Explosives", Verlag Chemie, NY (1977), 317

Y

Yaw. The angle between the direction of motion of a projectile and the axis of the projectile, referred to either as *yaw*, or more completely, *angle of yaw*. The angle of yaw usually varies periodically, but the mean yaw increases with time of flight in an unstable projectile, and decreases to a constant value, called the *yaw of repose* or the *repose angle of yaw* in a stable projectile

Exterior ballistic studies require the measurement of projectile yaw. Precise measurement of yaw requires the use of a series of spark or motion picture cameras located in two places at intervals down range. Reduction of data will produce information on yaw frequency and magnitude. Yaw may also be measured with a lesser degree of accuracy by the use of yaw cards, cardboard targets about the thickness of shirt cardboard placed at intervals down-range through which the projectile is fired. Measurement of hole elongation in the case of spin-stabilized rounds, and fin impression in the case of fin-stabilized rounds, along with measurements of length of projectile (base to beginning of taper or rotating band to fin) will give an indication of magnitude of yaw, while frequency may be determined by observing the distance between cards showing maximum amplitudes and knowing the projectile velocity at the cards

The drift of a spinning artillery shell results from the yaw of repose which develops as the

projectile tracks along a curvilinear flight path (Fig 1). Analytical expressions for the yaw of repose and drift of a spinning projectile have been developed by McShane et al (Ref 1), Murphy (Ref 4), and Vaughn and Wilson (Refs 5 & 6). The last source primarily addressed the ballistic matching of slightly dissimilar projectiles, ie, causing the respective mean impacts to be within prescribed dispersion limits. These authors stated that a ballistic match requires that the shells be gyroscopically stable, have similar ballistic coefficients, and develop similar yaw of repose angles during flight. Rollstin (Ref 9) fired a series of artillery projectiles with mass-property variations to determine the effect on the trajectory drift, and concluded that the drift of a spinning projectile is primarily caused by the yaw of repose

Refs: 1) E.J. McShane, J.L. Kelley & F.V. Reno, "Exterior Ballistics", University of Denver Press, Denver (1953) 2) Anon, OrdnTechTerm, ST 9-152, US Army Ordn School, APG (1962), 342 3) Anon, EngrgDesHndbk, "Elements of Armament Engineering, Part Two, Ballistics", AMCP 706-107 (1963), 3-4 to 3-5, 3-20 & 5-1 to 5-2 4) C.H. Murphy, "Free Flight Motion of Symmetric Missiles", Rept 1216, Ballistic Res Labs, APG (1963) 5) H.R. Vaughn & G.G. Wilson, "Yaw of Repose on Spinning Shells", SC-RR-70-155, Sandia Labs, Albuquerque (1970) 6) Ibid, "Effect of Yaw of Repose on Ballistic

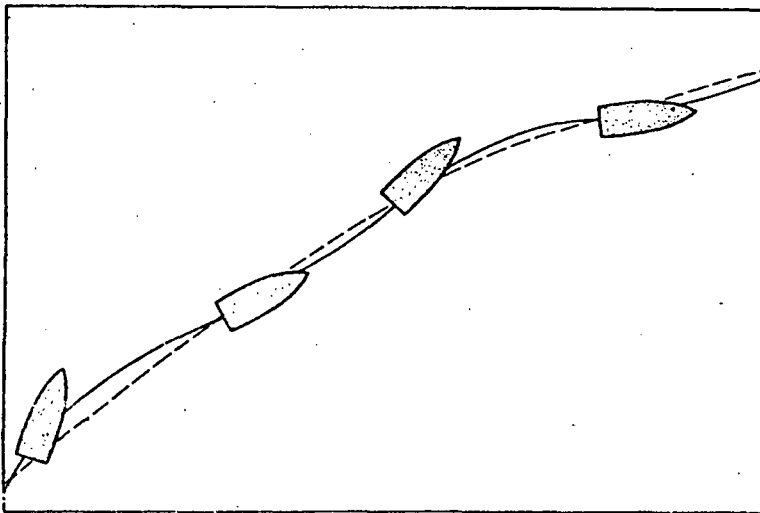

Fig 1 Section of a Trajectory with Yaw Oscillations

Match of Similar Projectiles", *AIAAJournal* **9** (1971), 1208-10 7) M.E. Backman, "Terminal Ballistics", *NWC TP-5780*, Naval Weapons Center, China Lake (1976), 45-47 8) Anon, *EngrDesHndbk*, "Recoilless Rifle Weapon Systems", *AMCP 706-238* (1976), 8-24 to 8-25 9) L.R. Rollstin, "Experimental Determination of the Artillery Shell Mass-Property/Trajectory-Drift Relationship", *JSpacecraft&Rockets* **16** (2) (1979), 108-14

Yield Stress. The idealized slurry fuel rocket proplnt must have a yield stress (defined as the minimum stress required to initiate flow) which imparts the necessary rigidity to the gel to prevent solid settling and shear thin to a value approaching the viscosity of the liquid. The yield stress needed to prevent settling of solid particles such as used in proplnts is not definite, but certain values are reported (Ref 2). The classical way to measure yield stress involves the extrapolation of the shear-stress rate curve (eg, as obtained from a rotational type viscometer) to zero shear rate. This method generally does not apply to the gelled slurries with a high volume percent of solids because of the great difficulty encountered in obtaining the consistency curve. The rising sphere method is frequently used to measure the minimum stress needed to produce flow (Ref 1)

The instrument consists of a steel sphere (2.063cm in diameter) attached by a length of thin steel wire to a load cell. The slurry sample rests on a horizontal cross arm which can be raised or lowered at controlled speeds. The sphere is placed in the lower third of the slurry sample, and the cross arm is lowered at a constant speed (8.5×10^{-4} cm/sec). The resulting force on the load cell is recorded vs time until the force reaches a constant value. The yield is then calculated using the equation:

$$\text{Yield stress} = \frac{(F - W_s) g}{4\pi r^2}$$

where F is the maximum recorded force in grains, W_s the weight of the sphere in the slurry, r is its radius, and g is the force of gravity.

The magnitude of the yield stress depends on the type of gellant used, its concentration, and the solids content. If the gellant is of the particu-

late type, such as finely divided carbon or pyrogenic silica, the yield stress will be quite low, even with 5-10% of gellant. If the gellant is a polymeric thickening agent, such as polystyrene in hydrocarbons which simply forms a viscous solution, it may have no yield stress. The presence of the solid powder fuel even at a high concentration in the gel, appears to have only a small effect (<10%) on the yield stress (Ref 3)
Refs: 1) D.E. McVean & A.M. Mattocks, *JPharm-Sci* **50**, 785 (1961) 2) A. Beerbower & W. Philippoff, *ProcAircraftFluidsFireHazard Symp* **86** (1966) 3) R.F. Gould, Ed, "Propellants Manufacture, Hazards and Testing", *Advances in Chemistry Series 88*, American Chemical Society, Washington (1969), 351-52

Yonckites. Safety expls, originally developed in Belg prior to WWI, based on Amm perchlorate (AP). Examples of these, used for rock blasting and coal mining, are shown in Table 1:

Table 1 (from Ref 5)
Composition of Some Belgian Safety Perchlorate Explosives

Ingredients, %	Yonckite type,	Yonckite type,
	brisant	antigrisouteuse
	No 13 (roche)	No 10 bis (couche)
Amm perchlorate	20	25
Amm nitrate	27	30
Na nitrate	27	15
Ba nitrate	6	—
TNT	20	10
Na chloride	—	20

One current compn consists of AP 43, Na nitrate 32, TNT 15 and Al powder 10%. Although originally invented for industrial use, many expls of this type have been used for military purposes, such as in demolition charges, and as the main filler for bombs, grenades, mortar shells, and land and sea mines (Ref 4). See also under "Perchlorate Cheddites" in Vol 2, C159

Refs: 1) Daniel (1902), 813 2) Stettbacher (1933), 316 3) Colver (1938), 251 & 280 4) Anon, "Handbook of Foreign Explosives", *FSTC-381-5042*, US Army Foreign Science and Technology Center, Washington (1965), 197 5) Urbański **3** (1967), 404

Yttrium Picrate. $[C_6H_2(NO_2)_3O]_3Y \cdot 16H_2O$, $C_{18}H_{38}N_9O_{25}$; mw 780.65, N 16.15%; OB to CO_2 -61.49%; transparent yel monoclinic columns. Prepn is by reacting PA with freshly pptd Y hydroxide. The picrate has an expln temp of 320°

Refs: 1) Gmelin, Syst No 39, Part C, Sect 2 (1973) 2) Ibid, Part D, Sect 1 (1977)
3) T. Ticholsky, "Thermal Analysis of Picrates ... Pre-explosion Temperatures of ... Y ...", ERDLT-1846-66, USAMEC, Fort Belvoir (1966) (AD 633414), 9 & 10

Yucca, Nitrated. Trench, Fauré and Mackie patented in 1876 (BritP 2742) the nitration of yucca for use as an expl
Ref: Daniel (1902), 773

Yuenyaku or Kokoshokuyaku. Japanese for Blk Pdr

Refs: 1) Anon, "Handbook of Foreign Explosives", FSTC-381-5042, US Army Foreign Science and Technology Center, Washington (1965), 188 2) R. Meyer, "Explosives", Verlag Chemie, NY (1977), 358

Yugoslav Weapons in Current Service.

	Type	Source, etc
Pistols	7.62mm M57 & M70(d)	--
	9mm M65	--
	9mm M70 & M70(k)	--
Sub-machineguns	7.62mm M49/57	--
	7.62mm M56	Support troops
Rifles	7.62mm M59/66	Copy of SKS with permanent grenade launcher. Made by Zavodi Crvena Zastava
	7.62mm M70	Yugoslav copy of AK-47
	7.62mm M70A	Yugoslav copy of the AK-47 with folding stock
Machine guns	7.92mm M53	Yugoslav manufactured copy of German MG42
	7.62mm M65A	Fixed heavy barrel version of M70 rifle
	7.62mm M65B	As M65A but with quick change barrel
	7.92mm M72	--
	.50-inch Browning	USA
Grenade, rifle	M60	Fragmentation, HEAT, Smoke & Illuminating
Mortars	50mm M8	Copy of British 2-inch mortar
	60mm M57	Copy of US M2 mortar
	81mm M31	Yugoslav design
	81mm M68	Yugoslav design
	120mm UBM 52	Yugoslav design
Anti-armor weapons	44mm M57 RL	--
	75mm M20 RCL Gun	USA
	82mm M60 RCL Gun	--
	105mm M65	--
	Sagger ATGW	USSR
	Snapper ATGW	USSR
Anti-aircraft weapons	12.7mm Degtyarev 38/46 HMG	Soviet. Obtained at end of WWII
	20mm AA cannon M1955	Triple mounting. Made in Yugoslavia by Zavodi Crvena Zastava
	37mm + 2x .50-inch Browning	Combined mounting. US design possibly now made in Yugoslavia
	30mm AA cannon M53 SA-7 SAM	Czechoslovakia USSR
Armored vehicles	M60 APC	Made in Yugoslavia
	BTR-152 APC	USSR
	Half-tracks	USA
	M980 MICV	Made in Yugoslavia

Detailed characteristics of the above weapons can be found in the Refs

Refs: 1) I.V. Hogg & J. Weeks, "Military Small Arms of the 20th Century", Hippocrene Books, NY (1977), 20, 55, 64, 105, 108, 117, 192, 195, 201, 214, 217 & 262 2) E.C. Ezell, "Small

Arms of the World", 11th Ed, Stackpole Books, Harrisburg, Pa (1977), 128, 474-75 & 623-27
3) J. Weeks, Ed, "Jane's Infantry Weapons, 1979-80", 5th Ed, Franklin Watts Inc, NY (1979), 679-80

Z

Zabel. Patented in Ger in 1899 a metallic cartridge consisting of two compartments divided by a thin partition. In one of the compartments was a mixt of Ca carbide and Ba peroxide, while the other contained a dilute acid soln. On breaking the partition, the acid reacted with the carbide and peroxide to form a mixt of acetylene and oxygen which immediately expld
Ref: Daniel (1902), 814

Zabudskii, G.A. (1854-1930). Russ artillery officer and professor of chemistry and expls at the Artillery Academy, St Petersburg. He did considerable work, in collaboration with D.I. Mendeleev (see Vol 8, M58-L), on the development and improvement of smokeless propnlts and the nitration of woodpulp and flax. Zabudskii was the founder, in 1909, of the TsNTLVV (Central Scientific and Technical Laboratory on Explosives)
Ref: A.Ya. Averbukh, ZhurPrikladKhimii 27, 801-03 (1954) (Engl translation 43G6R of Associated Technical Services, East Orange, NJ)

Zabudsky, N.A. (1853-1917). Russ ballistician, professor at the Mikhailovsky Artillery Academy, and successor to Mayevskii (see Vol 8, M47-L). In 1914 he published a monumental exptl work on the determination of pressures and velocities as functions of projectile travel for the 3" field artillery gun, which is still of practical value today. Zabudsky was elected a member of the French Academy of Science in 1911
Refs: 1) A.D. Blinov, "Kurs Artillereii, Voennoye Izdatel'stvo", Vol 1, Moscow (1948)
 2) M.E. Serebriakov, "Vnutrenniaya Ballistika Stvol'nykh Sistem i Porokhovykh Raket" (Interior Ballistics of Gun Barrel Systems and of Solid Rockets), Oboronghiz, Moscow (1962), 19 & 31

Zaliwsky. Proposed the addition of some oxalic acid to K chlorate, prior to mixing it with other ingredients in the prepn of expl formulations, in order to increase the safety of blending and loading operations
Refs: 1) Cundill (1899) in MP 6, 120-21 (1893) 2) Daniel (1902), 814

Zapata Chronograph. See Ref 2 in Vol 3, C317-L, under "Chronographs"

Zapon. A soln of NC in amyl acetate and amyl alcohol used as a suspending agent and binder for fusehead compns
Ref: S. Fordham, "High Explosives and Propellants", Pergamon Press, NY (1966), 119

Ze'ev. Israeli battlefield rocket. See under "Wolf" in this Vol

Zell-Igelit. Ger WWII porous vinyl chloride polymer laminate which was used as a coating on the air intake tube (schnorkel) and periscope of submarines to prevent detection by radar bearing aircraft

The pores of Zell-Igelit contained nitrogen generated within the material by a special process involving the use of a substance known as "Porofor N". A mixt consisting of polyvinyl chloride 95 and Porofor N 5% was autoclaved at 130°, and the resulting mass was then laminated. During this process the Porofor N dissolved in the vinyl chloride, and reacted with the liberation of nitrogen which formed bubbles inside the material. Each schnorkel tube or periscope was covered with 7 to 8 layers of the above porous laminate, each layer being separated from the others by sheets of carbon black coated paper, which were slightly conductive to electricity. It was assumed that the incoming short-wave radar generated convection currents within the carbon paper, and that these currents were subsequently buffered if not completely absorbed by the laminates. Reflection of the short-wave radar was thus minimized if not completely absorbed by the insulating mass
Refs: 1) Anon, CIOS Rept 25-18 (1945), 29-30
 2) B.T. Fedoroff et al, "Dictionary of Explosives, Ammunition and Weapons (German Section)", PATR 2510 (1958), 264

Zellpech. See under "Raschig Weisspulver and Raschit" in Vol 9

Zellstoffabrik. Patented in 1891 (GerP 1320) a procedure for the nitration of wood cellulose prep'd in the form of porous sheets resembling felt. It was claimed that this product resulted in enhanced stability

Ref: Daniel (1902), 814-15

Zeltit. See under "Celtite" in Vol 2, C125-R

Zerite. A slurry expl produced by the Oriard Powder Co, consisting primarily of Amm nitrate and Na nitrate with 20% water and organic solvents, and using S as the sensitizer. In addition, the Amm nitrate used is coated with wax, which serves as a fuel for the expl. Zerite's d is 1.34g/cc, deton vel 3660m/sec, detonation pressure 6.5GPa, and energy 4305kJ/kg

Ref: H.H. Reed, "A Review of Explosives Used in Explosive Excavation Research Laboratory Projects Since 1969", TID-4500, UC-35, Miscellaneous Paper E-74-6, US Army Engineer Waterways Expt Station, Expl Excavation Res Lab, Livermore, Ca (1974), 14, 15 & 23

Zhelatin (or Studenisty) Dinamit. See under "Russian Nonpermissible Explosives" in Vol 3, C441-R

Zhirov's Explosives (Zhirova Vzrychatyiye Veshchestva). HE mixts based on Tetryl (*Tetritl*) were patented in the USSR in 1927 as follows: a) Tetryl 100p and Amm perchlorate 150p are moistened with a mixt of amm hydroxide and acetone, ground, mixed and dried. b) Tetryl 100p and K perchlorate 120p are treated as above

Refs: 1) N.F. Zhirov, RussP 4283 & 4284 (1927) & CA 22, 4821 (1928) 2) Anon, "Handbook of Foreign Explosives", FSTC 381-5042, US Army Foreign Science and Technology Center, Washington (1965), 411 3) R. Meyer, "Explosives", Verlag Chemie, NY (1977), 358

Zinc. Zn, at wt 65.37, at no 30, valence 2, five stable isotopes. Shining white metal with bluish gray luster, sol in acids and alkalies, insol in w

Table 1
Comparison of Physical Properties of Zinc and Zinc Oxide
with Aluminum and Magnesium and Their Oxides

Property	Al	Mg	Zn
Atomic Weight	26.98	24.32	65.38
Density	2.70	1.74	7.14
Melting Point, °K	932	923	692.7
Boiling Point, °K	2720	1390	1181
Heat of Fusion, cal/g mole	2550	2140	1765
Heat of Vaporization, kcal/g mole	70.2	30.75	27.56
Property	Al ₂ O ₃	MgO	ZnO
Density	3.99	3.58	5.47
Heat of Formation (per mole O) kcal/g mole	-125.59	-142.95	-84.35
Melting Point, °K	2313	3173	(s) 2073
Boiling Point, °K	3773	3350	(d) 2223
Ratio vol metal/vol oxide	1.48	2.05	0.766
Heat of Fusion, kcal/mole	26.0	18.5	4.47
(s) sublimes	(d) decomposes		

Table 2

Thermodynamic Properties of Zinc (from Ref 1)

Heat Content and Entropy of Zn (c, l)
 (Base, crystals at 298.15°K)
 ($S_{298.15} = 9.95$ cal/deg mole)

T, °K	$H_T - H_{298.15}$ cal/mole	$S_T - S_{298.15}$ cal/deg/mole
400	625	1.80
500	1270	3.24
600	1940	4.46
692.7 (c)	2580	5.45
692.7 (l)	4345	8.00
700	4400	8.08
800	5150	9.08
900	5900	9.96
1000	6650	10.75
1100	7400	11.47
1200	8150	12.12
Heat Content and Entropy of Zn (g) (Base, ideal gas at 298.15°K) ($S_{298.15} = 38.45$ cal/deg mole)		
T, °K	$H_T - H_{298.15}$ cal/mole	$S_T - S_{298.15}$ cal/deg/mole
400	505	1.46
500	1005	2.57
600	1500	3.48
700	1995	4.24
800	2495	4.90
900	2990	5.49
1000	3490	6.01
1100	3985	6.49
1200	4480	6.92
1300	4980	7.32
1400	5475	7.69
1500	5975	8.03
1600	6470	8.35
1700	6965	8.65
1800	7465	8.94
1900	7960	9.20
2000	8455	9.46
2200	9450	9.93
2400	10445	10.36
2600	11440	10.76
2800	12435	11.13
3000	13425	11.47
3500	15910	12.24
4000	18400	12.90
4500	20905	13.49
5000	23435	14.03
6000	28675	14.98
7000	34385	15.86
8000	40905	16.73

Table 3

Thermodynamic Properties of Zinc Oxide (from Ref 1)

Heat Content and Entropy of ZnO (c)
 (Base, crystals at 298.15°K)
 ($S_{298.15} = 10.5$ cal/deg mole)

T, °K	$H_T - H_{298.15}$ cal/mole	$S_T - S_{298.15}$ cal/deg/mole
400	1070	3.08
500	2190	5.58
600	3350	7.69
700	4530	9.51
800	5740	11.13
900	6970	12.57
1000	8220	13.89
1100	9500	15.11
1200	10800	16.24
1300	12120	17.29
1400	13450	18.28
1500	14800	19.21
1600	16160	20.09
1700	17530	20.92
1800	18910	21.71
1900	20300	22.46
2000	21700	23.18
Heat Content and Entropy of ZnO (g) (Base, ideal gas at 298.15°K)		
T, °K	$H_T - H_{298.15}$ cal/mole	$S_T - S_{298.15}$ cal/deg/mole
400	795	2.28
500	1605	4.10
600	2435	5.61
700	3285	6.92
800	4140	8.06
900	5005	9.08
1000	5875	9.99
1200	7630	11.59
1400	9390	12.95
1600	11160	14.13
1800	12930	15.17
2000	14710	16.11

Zn is an element of the subgroup of the alkaline earths, is like them in many respects, but the metal and its oxide have relatively low boiling points and the heat of combustion is low as well. Consequently, Zn as a component in pyrot systems does little in the way of enhancing the flame temp. On the contrary, it finds application then when low combustion temps and

relative ease of initiation are desired. Zn and Zn compds, unlike their closely related Cd analogues, are non-toxic and they find application in smoke generating mixts or as inhibitors. Even here, metallic Zn contributes to making the systems unduly moisture sensitive. Zn has a number of important pyrotmetallurgical applications where it acts both as a solvent and as reducing agent, the reaction products being removable by vacuum distln. The physical properties of Zn and Zn oxide are compared with those of Al and Mg in Table 1. The thermodynamic properties are shown in Tables 2 and 3

Occurrence and Preparation

The principal Zn ores are Zn blende (Zn sulfide, sphalerite) and calamine (Zn carbonate, smithsonite), both of which can be converted into the oxide by roasting. The volatility of Zn at bright red heat enables the metal to be extracted from the ore by distln. Toward this end the powdered oxide is mixed with a stoichiometric excess of anthracite and heated to 1200–1300° in a retort causing the Zn oxide to be reduced:

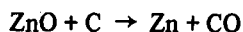

Zn vapor must be condensed below 415° in a stream of inert gas (ie, nitrogen) for the Zn dust to be formed (blue powder, Zn fume). Above 415° Zn condenses as the liq. Zn is more electro-positive than hydrogen, nevertheless it can be successfully electrodeposited from an aq soln at high current densities owing to the high hydrogen overvoltage on Zn (Ref 15)

Combustion of Zinc Powder

The combustion of Zn powder in air has been investigated (Ref 18). Owing to the higher vapor pressure of Zn compared with that of Al, ignition temps for Zn are also lower. Complete combustion of Zn powder takes place above 980° whereas the ignition temp for Al powder under the same exptl conditions is 1765° with a combustion temp of 2160–2290°. The process of self-oxidation of Zn dust is stimulated by humidity and the presence of chlorides, whereas the composition of the metallic phase, and the specific surface of the Zn dust were shown to be of minor importance in determining the pyrophoric properties (Ref 19). For a discussion of

the mechanism of Zn oxide on promoting the combustion of Al powder see Ref 12. When finely dispersed, Zn dust may be subject to dust explns

Wet Zn has a tendency to autoignition. Zn dust, when present in a pile, is difficult to ignite and never burns with an open flame. After wetting the dust with 10% NaOH, it will oxidize readily in air

Zinc as Ingredient in Pyrotechnic Smoke Mixtures

An important military application of Zn and of Zn oxide is as ingredient in the so called HC smoke mixts (see Ref 6 and Vol 8, P507-R). Similar compns produce smoke which is said to absorb low IR radiation (Ref 17). These mixts contain aromatic hydrocarbons which pyrolyze to form carbon particles > 10mμ in size, which are dispersed in a fog of hydrated metal chlorides. A non-toxic pyrot smoke compn is claimed by Praehauser et al (Ref 22) which comprises guanidine nitrate, a chlorinated hydrocarbon, and Zn powder. An example of the mixt was composed of C₂Cl₆ 34, powd Zn 22, ZnO 8 and guanidine nitrate 36%. The storability of pyrot smoke compns containing Zn was shown to be strongly affected by moisture which may bring about softening of seals and misfires due to the formation of ZnCl₂ and C₂Cl₄ (Ref 20). Zn and Teflon, when compacted, are said to constitute a smoke generating mixt which requires a temp of 420–50° to initiate (Ref 9)

Zinc in Advanced Electrochemical Power Sources

Zn and Cd find application as fuels in primary and secondary electrochemical energy sources. Primary batteries provide power for short periods and can serve as reserve sources of energy. Typical is the Ag oxide–Zn battery which has a specific energy of 350Wh/kg. A special form is the Ag peroxide–Zn system:

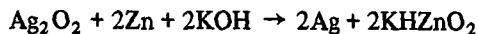

which is characterized by high discharge rates. This system exceeds all other state-of-the-art battery systems in power to weight ratio. The primary cells are represented by the familiar button type battery which are now common in all types of electronic devices

Secondary (rechargeable) batteries may also

Table 4
Comparison of Various Silver-Zinc and Silver-Cadmium Battery Systems (from Ref 11)

Battery System	Open Circuit Voltage	Working Voltage	Typ Energy Density	
			Wh/kg	Wh/cm ³
Silver-zinc, primary	1.85	1.3-1.55	100-200	0.2-0.45
Silver-zinc, secondary	1.85	1.3-1.55	60-160	0.1-0.3
Silver-zinc, remotely actv	1.85	1.2-1.55	10-80	0.02-0.2
Silver-cadmium, secondary	1.40	0.8-1.10	30-80	0.05-0.2

contain Zn, as shown in Table 4, and while these show high specific energies, the number of recharge cycles are usually less than are found in the Ni-Cd batteries. The Ag oxide-Zn primary battery has been developed to the point where it has a dominant role for space applications. In early satellites Hg oxide-Zn primary cells were used which had a specific energy density of about 110Wh/kg. The Zn-oxygen couple has also been considered (Ref 21). The improvement and development of rechargeable batteries is one of the principal challenges to electrochemistry. Unfortunately, at present the expected cycle life of the rechargeable Zn-Ag oxide cell is below that of the Cd-Ag oxide battery. One reason for this is the corrosive effect of the system on the cell membranes so that in order to minimize the tendency to self-discharge, the electrolyte is maintained separately from the electrodes during storage. A variant is the Zn-air battery which allows replacement of the spent Zn electrodes. This is a desirable feature for atmospheric applications and owing to the availability of "free" oxidizer, relatively high energy densities of 200Wh/kg are attained (Ref 10). A temp range between 0 and 70° is tolerated (Refs 10, 13 & 14)

Zinc as a Solvent in Pyrometallurgy

Zn is an uncommonly good solvent for other metals (Ref 2) except for the refractory metals and W. By taking advantage of the high vapor pressure of Zn, it may later be removed by vacuum distn, leaving behind the solute in very fine dispersion in a highly reactive form. Likewise, the use of liq Mg-Zn alloy for the reduction of U oxides, Pu dioxide and Th dioxide to the metal has been investigated (Ref 3). The oxides were suspended in a flux composed of

alkali and alkaline earth halides and reduced by vigorously mixing the slurry with the Zn-10% Mg alloy at temps between 650 and 800°. The reductions could be accomplished in an alumina crucible under an air atm. The element could later be recovered by vacuum distn of the Zn and the Mg

Ellern (Ref 7) reports the synthesis of W and Mo powder (both of which are insoluble in Zn) by mixing their oxides with a large excess of Zn dust. The powder mixt is compressed and heated to 500°, after which the process commences and completes within a few minutes. Admixture of Mg, as was done in the above Argonne National Laboratory studies, may obviate the need for high preheat temps

Miscellaneous Military Uses of Zinc

Zn can be used as an absorber of laser energy. When a laser beam strikes a surface, a hot plasma is formed which propagates up the laser beam (Ref 16). This plasma absorbs the beam so as to aid in shielding the surface. Tests with Zn have shown that the initiation time is about the same as for Al and Cu, but less than that of W

Zn has been evaluated as an additive for transpiration cooling of W nozzle inserts (Ref 4), taking advantage of the insolubility of W in Zn. This study was part of a development which saw the evaluation of Ag for this purpose, but which has since been superseded by carbonaceous composite nozzle inserts

Ellern (Ref 7) reports a commercially available practical pyrot heat source (for field applications, etc) which contains mixts of Zn, Ba chromate and Mg dioxide. A soldering iron is marketed which uses such a disposable thermal cartridge

The addition of powd Zn to solid proplnts as used in jet aircraft and ship models was observed to speed up combustion and allow for reduction in BlkPdr (Ref 5). The compn of this proplnt was reported to be Amm perchlorate 50, PVC 10, Zn 9, amm dichromate and cuprous oxide (catalyst) and BlkPdr 30%

US Military Specification for Zinc Dust

The principal military ordnance application of Zn is as dust. The allowable impurities are shown in Table 5

Table 5
Purity and Size Requirements for
Military Grade Zinc Dust

Property	Percentage	
	Maximum	Minimum
Total Zinc	—	97.5
Metallic Zinc	—	94.0
Zinc Oxide	6.0	—
Impurities other than zinc oxide	2.0	—
Moisture and other volatile matter	1.0	—
Matter soluble in organic solvents	0	—
Granulation Requirements:		
Sieve No 100	—	99
200	—	90
230	—	75

Zinc is determined quantitatively by titration of the acid solubilized material with K ferrocyanide, the endpoint being indicated when a drop of uranyl nitrate produces on a porcelain plate a brown tinge with a drop of titrated mixt. Metallic Zn is determined by the hydrogen evolution method using a gas burette (Ref 8)

Written by **A. P. HARDT**

Lockheed Missiles and Space Company, Inc

Refs: 1) Anon, EngrgDesHndbk, "Military Pyrotechnic Series, Part Three: Properties of Materials Used in Pyrotechnic Compositions", **AMCP 706-187** (1963) 2) I. Johnson & I.G. Dillon, "The Solubility of Metals in Liquid Zinc", **ANL-7083** (1965) 3) J.B. Knighton & R.K. Stennenberg, "Preparation of Metals by Magnesium-Zinc Reduction", **ANL-7057 & 7058**

(1965) 4) T. Sturiale et al, "Development of Manufacturing Methods for the Production of Infiltrated Tungsten Composite Rocket Nozzle Inserts", **AMFL-TR-66-316** (1966) (AD 803450) 5) O. Svejka & J. Kozeca, "Solid Fuels for Jet, Aircraft and Ship Models", CzechP 123107 (1967) 6) Anon, EngrgDesHndbk, "Military Pyrotechnic Series, Part One: Theory and Applications", **AMCP 706-185** (1967) 7) H. Ellern, "Military and Civilian Pyrotechnics", Chemical Publishing Co, NY (1968) 8) Anon, US Military Specification, "Zinc Dust (For Use in Pyrotechnics)", **MIL-Z-365A** (1968) 9) A.G. Rozner & H.H. Helms, Jr, "Heat Initiated Smoke Generating Compositions", USP 3634283 (1968) 10) D. Linden, "Application of the Mechanically Rechargeable Zinc-Air Battery", **ECOM 3086** (1969) 11) C.L. Mantell, "Batteries and Energy Systems", McGraw Hill, NY (1970), 89 12) M.N. Chesnokov, FizAerodisperanykhSist, No 4 (1971), 7209 13) R. Rinaldi, "Engineering Evaluation on Non-Reserve Zinc-Air Cells", **ECOM 3528** (1972) 14) C.A. Nordell, "Limiting Factors for Zinc-Air Batteries at Low and Elevated Temperatures", **ECOM 3553** (1972) 15) J.W. Mellor, "Inorganic and Theoretical Chemistry", Vol IV, J. Wiley & Sons, NY (1960), 411 16) C.T. Walters et al, "An Investigation of Mechanisms of Initiation of Laser Supported Absorption Waves" (1975) (ADA 024496) 17) U. Krone, "Pyrotechnical Smoke", GerP 2556256 (1977) 18) M.E. Derevyaga et al, "Ignition and Combustion of Aluminum and Zinc in Air", Fizika-Goreniya i Vzryva 13 (No 6) (1977), 852-57 19) Z. Bylo & A. Shiwa, CA 88, 140541 (1978) 20) I. Maak, CA 89, 8468 (1978) 21) E. Hollax, "Advanced Electrochemical Sources for Space Power Systems - A Review", J of Power Sources 4, 11-19 (1979) 22) G. Praehauser & A. Schiessl, "Pyrotechnic Smoke Compositions", GerP 2819850 (1979)

Zinc Abietate (Zinc Resinate). $C_{20}H_{24}O_2Zn$; mw 361.82; clear amber lumps or pdr. Sol in amyl alc or eth. Prepn is by fusion of Zn oxide and rosin, or from solns of Zn salts and abietic acid. The finely divided material is spontaneously ignitable and is usually stored in metal containers

Refs: 1) Gmelin, Syst No 32, and supplements (1969 & 1979) 2) CondChemDict (1977), 941 3) Bretherick (1979), 96 & 190

Zinc Acetylide. See in Vol 1, A83-L

Zinc Amalgam. Hg-Zn. Amalgamated Zn residues, isolated from a Clemmenson reduction of an alkyl aryl ketone in glacial acetic acid, were found to be pyrophoric, and must be drowned in w immediately after filtrn to prevent ignition
Ref: Bretherick (1979), 1012

Zinc Ammonium Nitrite. $\text{ZnNH}_4(\text{NO}_2)_3$; mw 221.46; white pdr; mp, 'decomps on heating. Sol in w. Prepn is by reacting $[\text{ZnNH}_3]^+$ with nitrous acid. The compd is a dangerous fire risk; a very strong oxidizing agent which can initiate an expln on contact with org matls
Refs: 1) Gmelin, Syst No 32 (1976) 2) M.C. Sneed & R.C. Brasted, "Comprehensive Inorganic Chemistry", Vol IV, VanNostrand, Princeton (1955) 3) Sax (1968), 1242 4) CondChem-Dict (1977), 937

Zinc Azidodithiocarbonate. See in Vol 1, A637-L

Zinc Benzenediazonium Chloride. $\text{C}_6\text{H}_5\text{N:NCl}$. ZnCl_2 , $\text{C}_6\text{H}_5\text{N}_2\text{Cl}_3\text{Zn}$; mw 276.87; N 10.12%; solid. A self-reactive compd which has been known to expld after 15 hrs storage in a vac desiccator

Ref: Anon, "Fire Protection Guide on Hazardous Materials-7th Ed", Natl Fire Protection Assn, Boston (1979), 491M-443

Zinc Bromate. $\text{Zn}(\text{BrO}_3)_2 \cdot 6\text{H}_2\text{O}$; mw 429.28; white deliq crysts; mp 100° ; sp grav 2.566. V sol in w. Prepn is by treating Zn oxide with bromine w. Intimate mixts of the bromate with finely divided Al, As, Cu, C, P, S hydrides of alkali and alkaline earth metals, Sb sulfide, metal cyanides, K thiocyanate or impure Mn dioxide can react *explosively* (spontaneously in the pre-

sence of w) on initiation by heat, mechanical means, sparks, or the addn of sulfuric acid
Refs: 1) M.C. Sneed & R.C. Brasted, "Comprehensive Inorganic Chemistry", Vol IV, VanNostrand, Princeton (1955), 48 2) Bretherick (1979), 106 3) Anon, "Fire Protection Guide on Hazardous Materials-7th Ed", Natl Fire Protection Assn, Boston (1979), 491M-442

Zinc Bromide. ZnBr_2 ; mw 225.18; v hydr rhombic cryst with a brilliant white luster and a sharp metallic taste; mp 394° ; bp 697° (partial decompn); d 4.22g/cc; RI 1.5452. V sol in 90% ethanol, acet, eth, ammonia, solns of alkali hydroxides and w. Prepn is by treating metallic Zn with bromine vapor. Accdgt to Ref 3, mixts of the compd with either K or Na form strong, impact sensitive expls

Refs: 1) M.C. Sneed & R.C. Brasted, "Comprehensive Inorganic Chemistry", Vol IV, VanNostrand, Princeton (1955), 54 2) Merck (1976), 1307 (No 9786) 3) Anon, "Fire Protection Guide on Hazardous Materials - 7th Ed", Natl Fire Protection Assn, Boston (1979), 491M-443

Zinc Carbonate. See in Vol 2, C59-R

Zinc Chlorate. See in Vol 2, C201-R to C202-L

Zinc Chloride. ZnCl_2 ; mw 136.28; white deliq, hexagonal crysts of waxy consistency; mp 262° , 283° (sep values); bp 732° , d 2.91g/cc at 25° , RI 1.681, 1.713 (sep values). V sol in eth and w; sol in ethanol, insol in ammonia. Prepn is by distln of anhydr Zn sulfate with Na chloride. The chloride is formed on combstn of HC smoke mixts (Ref 2). Accdgt to the NFPA (Ref 4), a mixt of the chloride with K forms a strong, impact sensitive expl

Refs: 1) M.C. Sneed & R.C. Brasted, "Comprehensive Inorganic Chemistry", Vol IV, VanNostrand, Princeton (1955) 2) Ellern (1968), 150 3) Merck (1976), 1307 (No 9789) 4) Anon, "Fire Protection Guide on Hazardous Materials-7th Ed", Natl Fire Protection Assn, Boston (1979), 491M-444

Zinc Chlorite. See in Vol 3, C246-R

Zinc Chromate. See in Vol 3, C283-L

Zinc Dialkyls

These compds are spontaneously flammable in air, and react explosively with acyl halides, alkyl chlorides and methanol (Refs 1, pp 23-24; 5, pp 44-45; & 6, p 491M-444). Several of the most active examples of this group are described below:

Zinc Diethyl. $Zn(C_2H_5)_2$, $C_4H_{10}Zn$; mw 123.50; mobile pyrophoric liq, stable in a sealed tube under CO_2 ; mp -28° ; bp 118° ; d 1.2065 g/cc at $20/4^\circ$; RI 1.4936. Misc with benz, eth, petr eth and other hydrocarbons. Prepn is by interaction of Zn with ethyl iodide. Ignites instantly on contact with air, burning with a blue flame while emitting a garlic-like odor. Reacts with expl violence on contact with w. The compd has a heat of combstn of 6481 ± 4 cal/g. Accdg to Bigson & Weber (Ref 3), it has been used as a flame thrower igniter. They also report that toxic Zn oxide fumes are generated on combstn, with a toxic threshold value of 5mg/cm (Refs 3, p 180; 4, p 415 (No 3119); & 6, pp 99-132)

Zinc Dimethyl. $Zn(CH_3)_2$, C_2H_6Zn ; mw 95.45; mobile pyrophoric liq, stable in a sealed tube under CO_2 ; mp -40° ; bp 46° ; d 1.386g/cc at $10.5/4^\circ$. Sol in eth and misc with hydrocarbons. Prepn is by interaction of Zn with methyl iodide. It burns with a pale blue flame, emitting a garlic-like odor. It has a heat of combstn of 5050 ± 15 cal/g (Refs 2, p 1245; 3, p 179; & 4, p 434 (No 3254))

Zinc Dipropyl. $Zn(C_3H_7)_2$, $C_6H_{14}Zn$; mw 151.55; mobile pyrophoric liq, stable in a sealed tube under CO_2 ; bp 160° ; d 1.1034g/cc at $20/4^\circ$; RI 1.4845 at 18.6° . Sol in org solvents; decomps explosively on contact with w. Prepn is by reacting n-propyl iodide with Zn. The compd has a heat of combstn of 1113.3 ± 5.6 kcal/mole (Refs 3, p 181; & 6, p 491M-444)

Zinc Divinyl. $Zn(CH_2:CH)_2$, C_4H_6Zn ; mw 119.42; mobile pyrophoric liq which is stable in a sealed tube under CO_2 ; bp 32° at 22mm.

Prepn is by reacting Zn chloride with vinyl Mg bromide. It reacts with expl violence on contact with w (Refs 3, p 179; & 6, p 491M-445)

Refs: 1) Ellern (1968) 2) Sax (1968)

3) J.R. Gibson & J.D. Weber, "Handbook of Selected Properties of Air- and Water-Reactive Materials", Naval Ammo Depot RDTR 144, Crane (1969) 4) Merck (1976) 5) Bretherick (1979) 6) Anon, "Fire Protection Guide on Hazardous Materials-7th Ed", Natl Fire Protection Assn, Boston (1979)

Zinc Diamminoazide. $Zn(NH_3)_2N_6$, H_6N_8Zn ; mw 183.52; N 61.07%; white acicular cryst; mp, explds at 289° . Prepn is by passing dry ammonia gas thru a methanolic soln of Zn azide

Refs: 1) Gmelin, Syst No 32 (1979)

2) Mellor 8 (1940), 350-51

Zinc Diazide. See in Vol 1, A624-L

Zinc Dihydrazide (Zinc hydrazine).

$Zn(NHNH_2)_2$, H_6N_4Zn ; mw 141.49; N 39.61%; solid; mp, explds at 70° . Prepn is by the action of hydrazine on Zn diamide or Zn diethyl

Refs: 1) Bretherick (1979), 1004 1) Anon, "Fire Protection Guide on Hazardous Materials-7th Ed", Natl Fire Protection Assn, Boston (1979), 491M-443

Zinc Dipicrate. See in Vol 8, P283-R under "Zinc Picrate"

Zinc Ethylsulphinate. $Zn(OS(O)C_2H_5)_2$, $C_4H_{10}O_4S_2Zn$; mw 251.64; OB to CO_2 -57.22%. Prepn by addn of Zn diethyl to liq SO_2 at -15° leads to an explosively violent reaction. However, condensation of the dioxide into cold Zn diethyl leads to a controllable reaction on warming

Ref: Bretherick (1979), 509

Zinc Hydrazide. $NHNHZn$, H_2N_2Zn ; mw 95.42; N 29.36%; pyrophoric solid. Prepn is by reacting w (cautiously) with Zn nitride. The

compd ignites spontaneously in air

Refs: 1) M.C. Sneed & R.C. Brasted, "Comprehensive Inorganic Chemistry", Vol IV, VanNostrand, Princeton (1955) 2) Bretherick (1979), 958

Zinc Hydride. ZnH_2 ; mw 67.40; white, non-volatile solid; mp, decomps slowly at RT. Insol in eth. Prepn is by reaction of Zn dimethyl with $LiAl$ hydride in eth at 20° ; yield is 96%. Aged or partially decompd samples contg finely divided Zn may ignite spontaneously in air. Accdg to Ref 3, the hydride forms complexes with Mg and other alkali metals which may be useful as high energy fuels for use in solid rocket proplnt motors

Refs: 1) G.D. Barbaras et al, "Preparation of Zinc . . . Hydride", JACS 73, 4587 (1951) & CA 46, 4407 (1952) 2) M.C. Sneed & R.C. Brasted, "Comprehensive Inorganic Chemistry", Vol IV, VanNostrand, Princeton (1955), 53 3) E.C. Ashby et al, "Preparation of New Metal Hydrides: $MgZnH_4$ and $Mg(ZnH_3)_2$ ", Georgia Inst Technol, ONR Contract N00014-67-A-0159-005 (1976), (AD-A023783)

Zinc Hydroxide. $Zn(OH)_2$; mw 99.40; colorl cryst; mp, decomps at 125° ; sp gr 3.053; RI 1.57. Sol in ethanol and aq bases; v sl sol in w. Prepn is by addn of a strong alkali to an aq soln of a Zn salt. Accdg to Bretherick (Ref 2), an intimate mixt of the hydroxide with chlorinated rubber will react explosively when heated to about 216°

Refs: 1) CondChemDict (1977), 939 2) Bretherick (1979), 34 & 970

Zinc Iodide Test. A Ger modification of Abel's Test or the K iodide-starch test (see Vol 1, A2-L) in which Zn iodide is used in place of K iodide, thus rendering the test more sensitive. The conditions of testing are given by Kast and Metz

Ref: H. Kast & L. Metz, "Chemische Untersuchung der Spreng- und Zundstoffe", Vieweg, Braunschweig (1944), 227

Zinc Nitrate. See in Vol 8, N40-L and the following *Addnl Refs*: 1) G.W. Batchelder & G.A. Zimmerman, "Smokeless Propellant Compositions Containing a Polyester Resin", USP 3653993 (1972) & CA 79, 77449 (1973) [The inventors claim that Zn nitrate acts as the burning rate catalyst in their proplnt formulation. Thus, the addn of 0.1% Zn nitrate to a proplnt contg AN (45), amm dichromate (5%), a polyester, styrene, methacrylate and lecithin increased this parameter from 0.07 to 0.11 inches/sec] 2) Anon, "Fire Protection . . . 7th Edition", NFPA, Boston (1979), 491M-445 [This source reports that Zn nitrate will expld if sprinkled on hot C. Also, that heat, shock and friction sensitive expls are formed when the nitrate is intimately mixed with the following finely divided materials: Cu, metal sulfides, organic matter, P and S]

Zinc Nitrodiglycolamidic Acid Salt. See in Vol 5, D1262-R

Zinc Nitrohydrazinate. See in Vol 7, H200-L & R

Zinc Oxide. See in Vol 8, O53-L to O54-L and the following *Addnl Refs*:

Explosives: 1) K. Takata & H. Sakamoto, "Preventing the Caking of Ammonium Nitrate for Use in Explosives", GerP 1906776 (1969) & CA 71, 126723 (1969) [The inventors claim that a mixt of 97p of Zn oxide together with 3p of octadecylamine acetate plus a small amt of w form an adduct which when added (0.5p) to 99.5p of AN (in any mechanical form) prevents the expected agglomeration of the AN to the extent of 90%. This product (6p) plus fuel oil (94p) is reported to detonate at the rate of 2900m/sec] 2) S. Varma & R.C. Saxena, "Influence of Additives on the Hazardous Behavior of Ammonium Nitrate", Techny 7 (3), 145-48 (1970) & CA 75, 4838 (1971) [The effect of additives such as ZnO, urea and Ca phosphate on the decompn of AN was detd thermogravimetrically. The authors report that the expln temp of AN was highest (340°) when Zn oxide was added, followed by that obtd upon urea addn (333°), with the lowest expln temp

being found upon addn of Ca phosphate (285°). It was also found that when the exptl mixts were heated for 4 hrs at temps of 225 and 245°, the Zn oxide mixt exhibited minimal decompn in terms of wt loss, and that the pH of an 8% soln of its residue was the highest of those examined]

3) K.R.V. Szarmes & J.M. Rauardhya, "Stabilized Particulate Ammonium Nitrate", CanadianP 879586 (1971) & CA 75, 119637 (1971) [These workers report the stabilization of AN against the orthorhombic-pseudotetragonal phase transition which occurs at 32° by addn of 0.8 to 1.3 wt % of Zn oxide]

Propellants: 1) D.E. Jacobsen & S.Y. Ek, "Gun Barrel Wear Reduction Additives", USP 3403625 (1968) & CA 70, 13144 (1969), also, Ibid, SwedP 212983 (1967) & CA 70, 69756 (1969) [The inventors suggest addn of Zn oxide to a mixt applied as a coating on the inner surface of the rayon, silk or nylon proplnt wrap as a claimed means of limiting gun barrel wear or erosion to less than 5% of nominal values]

2) M. Holgerson, "Plastic Rocket Propellants", GerP 2006229 (1971) & CA 74, 113925 (1971) [The use of Zn oxide is suggested as an oxygen source in a solid proplnt which is claimed can be used immediately without being mixed in vacuo to remove air bubbles. Thus, AN (60), polyisobutylene (14), lecithin (1) and Zn oxide (25%) are mixed at 70° to prepare the invented proplnt]

Pyrotechnics: 1) V. Deisenroth, "Smoke- or Fog-Producing Composition", GerP 2451701 (1974) & CA 85, 80508 (1976) [Claimed are smoke generating compns contg a high metal content which are considered as being "safe . . . and . . . effective". Thus, a solid chloroparaffin (contg 56% Cl) (2400g) is melted with a non-ionogenic crosslinking agent (25g), Zn oxide (2600g), and Al dust (600g) to form a homogeneous mass of 3.2g/cc density, which is reported to burn at 1.5cm/minute, providing a dense greyish-white smoke with excellent ground coverability] 2) A. Jarvis, "Smoke-Generating Compositions", CanadianP 1063907 (1979) & CA 92, 149494 (1980) [Claimed are smoke generating compns prepared from a highly chlorinated org compd, a Si alloy and Zn oxide. Thus, a typical smoke compn was prepd from Zn oxide (40), pentachloronitrobenzene (30) and the Si alloy (30%)]

Zinc Perchlorate. See in Vol 8, P169-R and the following *Addnl Ref:* F. Solymosi & J. Rasko, "Thermal Decomposition and Ignition of Ammonium Perchlorate in the Presence of Zinc Perchlorate", ZPhysChem (Frankfurt) 67 (1-3), 76-85 (1969) & CA72, 104394 (1970) [The authors found that addn of Zn perchlorate to AP markedly effected its rate and extent of decompn. The catalytic reaction obeys 1st order kinetics, the activation energy is reported as 37kcal. It was also found that the compd exerts a great influence on AP's ign temp, lowering it by approx 200°]

Zinc Permanganate. $Zn(MnO_4)_2 \cdot 6H_2O$; m w 411.33; violet-brn or blue deliq ndles which decomp on exposure to light and air; mp, loses $5H_2O$ at 100° in vac, decomp above 100°, d 2.47g/cc; Vsol in hot w; sol in cold w; decompd by ethanol or acids. Prepn is by treating $BaMnO_4$ with a soln of Zn sulfate and evapg the filtrate. Accdg to Soergel (Ref 2) an expln is produced on intimate contact with cellulose
Refs: 1) Merck (1976), 1309 (No9814)
2) U.C. Soergel, Pharm Praxis Beil Pharmaz (2), 30 (1960)

Zinc Perchlorate Tetra-Animoniato. See in Vol 8, P170-L

Zinc Peroxide. $ZnO_2 \cdot \frac{1}{2}H_2O$; mw 106.38; yellowish powder which decomp slowly at RT; mp, rapid decompn over 150°; d $3.00 \pm 0.08g/cc$; RI 1.63. Decompd by most solvents; forms slurries, not solns. Prepn is by treating a Zn chloride soln with Na peroxide at a pH of 9.5 at 12° (Refs 1 and 3). Accdg to ref 4 the peroxide explds when heated to about 212°; when heated with Al or Zn powder, it burns with a dazzling light. The peroxide is used as the oxidizer in a plastic binder compn for rocket bodies, so that the casing will self-destruct in 35 secs (Ref 2). See also in Vol 8, P195, Table 5

Refs: 1) M.C. Sneed & R.C. Brasted, "Comprehensive Inorganic Chemistry", Vol IV, Van Nostrand, Princeton (1955), 57 2) N. Hirota, "Resin Compositions for Self-Destructing Rocket

Bodies", JapP 7309937 (1973) & CA80, 121816 (1974) 3) ChemRubHndbk (1978), B-176 4) Anon, "Fire Protection. . . 7th Edition", NFPA, Boston (1979), 491M-30

Zinc Picrate. See in Vol 8, P283-R

Zinc Stearate. See in Vol 9, S212-R

ZIRCONIUM AND HAFNIUM

Introduction

Zirconium and hafnium are two refractory elements which are closely related to titanium (see Encycl Vol 9, T227-R) but which in addition to having desirable corrosion resistance and mechanical properties, have many significant ordnance applications. Hf free Zr moreover is possessed of a low neutron capture crosssection, and is therefore of value as a reactor material. In as much as Hf is chemically similar to Zr and as in nature it is always found in association with Zr, it will be discussed as part of the Zr technology, except where its special properties

have found application. For the sake of completeness, comperable data for Ti are shown as well. The physical properties and the approximate price of the metals are compared in Table 1

Sources of Technical Data

Input data for thermochemical calcns are obtainable from the JANAF Tables (Ref 34), Wicks and Block (Ref 6) and Hultgren (Ref 4). A useful collection of metallurgical, nuclear and processing data is available from Teledyne Wah Chang Albany, Inc, Albany, Oregon 97321 (Ref 29). Thermophysical data are listed by Landolt-Boernstein (Ref 8). A limited compilation of some Zr and Ti data was published by the US Army Material Command (Ref 5). A current source of economic and processing data is the Kirk-Othmer Encyclopedia of Chemical Technology (Ref 33)

Neutron Absorption Characteristics

The thermal neutron absorption crosssection for Zr is $0.18 \times 10^{-28} \text{m}^2$ (*) while the scatter crosssection is $8 \times 10^{-28} \text{m}^2$. Naturally occurring Hf has an absorption crosssection for thermal (0.0253 eV) neutrons of $105 \times 10^{-28} \text{m}^2$, the

(*) $1 \text{m}^2 = 10^{28}$ barns

Table 1
Physical Properties

	Titanium	Zirconium	Hafnium
Atomic Number	22	40	72
Atomic Weight	47.90	91.22	178.49
Density, g/cm ³	4.54	6.49	13.09
Crystal Transformation Temperature from HCP to BCC, °K	1155	1143	2013
Melting Point, °K	1943	2125	2500
Boiling Point, °K	3562	4688	4876
Melting Point of Oxide, MO ₂ , °K	2143	2950	3063
Boiling Point of Oxide, MO ₂ , °K	4900	5300	5500
Metal Temperature at Pressure of 10 ⁻¹ Pa, °K	1827	2424	2470
Heat of Formation of the Oxide, kJ/mole, 298°K	-945.2	-1094.6	-1113.7
Price per kg, September 1980 Fine Sponge	\$22-28	\$17-28	\$100-170
. Powder, 200/325 mesh	\$150-170	\$150	\$330

scattering cross-section being about the same as for Zr. Hf has proven to be an outstanding control rod material because of its excellent corrosion resistance, mechanical properties and neutron absorption characteristics. Its effectiveness does not diminish appreciably with irradiation and the ability of Hf to absorb neutrons above thermal energies makes it doubly effective as an absorbing material (Ref 29)

Military Specifications for Zirconium and Zirconium Compounds

Analytical and purity specifications for various grades of Zr and Zr compounds of interest to ordnance applications are provided in the following documents:

Zirconium (granular and powdered)	MIL-Z-399D (5 April 1973)
Zirconium Sponge	MIL-Z-50976 (30 September 1971)
Zirconium, powdered, 0.75-9 μ m, <0.2% hydride	MIL-Z-47157(MI) (7 June 1974)
Zirconium-Nickel Alloy, Powdered, -325 mesh, Type I 70/30 Zr/Ni, Type II 30/70 Zr/Ni	MIL-Z-11410B (12 February 1968)
Zirconium Carbide, Powdered, Technical	MIL-Z-82674 (OS) (23 November 1977)
Zirconium Hydride	MIL-Z-21353 (25 March 1958)
Zirconium Nitrate, Reagent,	MIL-Z-11144 (CmlC) (10 May 1951)

Sources, Supply and Economics

The principle Zr ore, zircon (Zr silicate) is processed by caustic fusion or by direct chlorination of milled coke and zircon mixts. Washing of the Na fusion cake leaves an acid soluble hydrated Zr oxide, whereas chlorination yields mixed Si and Zr tetrachlorides which are separated by distillation. Removal of the Hf from the Zr takes place through counter current liq-liq extraction (Ref 33). For this purpose the oxide or the tetrachloride is dissolved in dil hydrochloric acid to which ammonium thiocyanate is added as a complexing agent. The organic extracting phase is methyl isobutylketone

containing thiocyanic acid. Hf is preferentially extracted into the ketone whence it is recovered by scrubbing with 5N sulfuric acid and precipitated by neutralization. The Zr hydroxide is similarly recovered from the hydrochloric acid stream. The resulting Hf and Zr hydroxides are calcined to the dioxide. The dioxide is pelletized with carbon and chlorinated. The reduction of the purified tetrachloride may be accomplished in a batch process with metallic Mg (Kroll process) or with Na. The metallic product remaining in the reactor after leaching is known as sponge which may be used for pyrotechnic purposes directly after crushing and screening. Alternately, vacuum melted Zr may be hydrided causing it to become particularly frangible, facilitating the crushing operation. After screening, the resulting hydride powder is converted to the metal by heating in a vacuum furnace. Zr can be forged, swaged, rolled or welded under conditions of controlled temp and pressure. The sponge can be pressed directly without previous processing although it is difficult to machine in that form. Wrought Zr can be machined in the same manner as Ti and stainless steel, although the metal tends to gall and flow rather than cut. Turnings and shavings will often ignite, requiring water, soluble oils or air jets as cooling medium.

Occurrence and Economic Factors Affecting Price Structure

The estimated world resources of Zr were published in 1968 (Ref 13). The United States is believed to have the largest reserves of Zr in the world, as shown in Table 2. But the recovery of Zr from domestic sources is economically feasible only as a byproduct of the Ti manufacture. Large quantities of zircon are obtainable through the mining and processing of phosphate rock. Commercial recovery of Zr from these sources is subject to the economics of Zr utilization.

Australia continues as the world's largest producer of zircon of which most is used as recoverable foundry sand. The demand for metallic Zr has not kept pace in the last decade with the production capacity, mainly because of the unforeseen drop in demand for nuclear grade (ie, Hf free) Zr. Because the production

of Hf is directly tied to the production of reactor grade Zr, the supply of Hf has decreased while the demand remains strong. Table 3 lists the estimated world production figures for Hf (Ref 33). The situation is reversed for Ti for which the demand has significantly increased owing to the requirements of the military aircraft industry.

Table 2
Estimated World Reserves of Zirconium in 1968
(from Ref 13)

	Reserves 1000s Metric Tons
<u>Associated with Rutile (ZrO₂)</u>	
Australia	2,950
Sierra Leone	450
<u>Associated with Ilmenite</u>	
Australia	540
India	1,200
United States	5,625
USSR	2,700
Ceylon	450
Other *	<u>1,350</u>
Total	15,265
World Production in 1968	223,000 metric tons
* Republic of South Africa, Malagasy Republic, Brazil, Thailand	

Table 3
Estimated Production of Hafnium
(from Ref 33)

<u>Non-Communist World</u>	
<u>Metal Content of Oxide Produced</u>	
<u>Year</u>	<u>Metric Tons</u>
1958	28
1963	50
1968	75
1973	135
1978	<u>170</u>

Consequently Ti sponge has quadrupled in price from 1975 to 1980, whereas the price of Zr has only doubled. It is expected that the relative price level of Zr will continue to swing widely, affecting the choice of Zr for some ordnance application. Earlier economic assessments regarding the high cost of Zr are quite invalid today, and it is expected that Zr will continue to remain attractive. The cost of the mineral raw material used in producing Zr metal is small compared with production costs and changes in the price of zircon are not necessarily reflected in the price of the metal. Whereas historically the adjusted price for the mineral and the metal have been sharply downward, this trend seems to have been revised and in future the metal price will be better correlated with the cost of electric power.

Owing to the limited domestic supply of rutile (a mixed titania and zirconia containing ore) much effort is being directed toward commercial development of rutile made from ilmenite, an abundant Ti ore. A factor for a long term pressure on the price of Zr is the probability of utilization of rock deposits of ilmenite as the principle source of Ti. Rock-type deposits do not contain Zr in recoverable quantities.

Safe Handling of Zirconium

Numerous instances of spontaneous ignition and explns of Zr powder in both open and sealed drums have been reported. Zr powder handling or processing operations such as grinding, washing, drying, screening, weighing, blending, etc, should be conducted carefully in segregated rooms or enclosures where the powder can be handled in small batches and precautions can be taken to avoid injury to personnel and extensive damage to property.

The importance of good housekeeping must be emphasized. Any accumulation of Zr dust or powder on work benches, floors or clothes of personnel must be removed promptly. The pyrophoric properties of Zr dust or powder requires the selection of either wet or dry methods of dust collection. A limited amount of moisture can make Zr powder ignition sensitive, but attempts to collect the dust dry by suction or convection flow risk dust explns which are easily initiated by static discharge or spontaneous combustion. Because nitrogen will also react with Zr,

Table 4
Hazard Ranges for Zirconium Particles (from Ref 12)

<u>Classification</u>	<u>Range of Particle Sizes</u>		<u>Condition under which Self-Ignition Occurs</u>
	<u>Minimum</u>	<u>Maximum</u>	
Fine Powder	—	<0.01mm	Easily Ignitable
Fine Powder	>0.01mm	<0.85mm	Ignitable with high temperature spark
Fine Chips	>0.85mm	<1.36mm	Flame required for ignition
Coarse Chips	>1.36mm	—	Burns only when high temperature is applied for long periods

carrier gases must be inert. As an alternative, precipitation of the dust by an excess of water is recommended (Ref 17)

The hazards involved in handling or storing Zr scrap containing considerable amounts of fines frequently outweigh any savings to be gained by salvaging it. Such material is best disposed of by burning. Small quantities can be buried when mixed with a sufficient excess of sand or other inert material to eliminate any possibility of later ignition. Where there is a continuing need for disposal of sludge as fine scrap, special burning facilities should be provided

Disposal of old or waste Zr powder which is packed either wet or dry in closed containers presents some additional hazards when attempts are made to open the containers. Particularly risky is the "digging" out of the Zr which may have settled. Whereas it is considered safe practice to douse or flood Zr fines with at least five parts of water, once the Zr has settled and caked, one cannot really assume that the metal is in contact

with an excess of water. In this case, the safest procedure would be to burn the Zr scrap, but otherwise an attempt might be made to dislodge the cake by prolonged tumbling of the containers

In the experience of the author, commercially procured Zr fines are frequently not pyrophoric. It may well be that the apparent inertness of the powder is due to partial hydride formation by gradual reaction with the occluded moisture. Such hydrides can be reduced to the metal by gently heating in vacuum at 200°, after which the powder may be extremely reactive, requiring handling in an inert atm. The industrial procedure is to handle in inert atms all materials smaller than 150 mesh, such as sawdust, fine turnings, floor sweepings, blender, crusher and tumbler fines, grinder dust, dehydrides powders and leached powders (Ref 30). Recommended quantities for safe storage around working areas are shown in Fig 1. Hazard ranges for various Zr particle size ranges are listed in Table 4 (Ref 12)

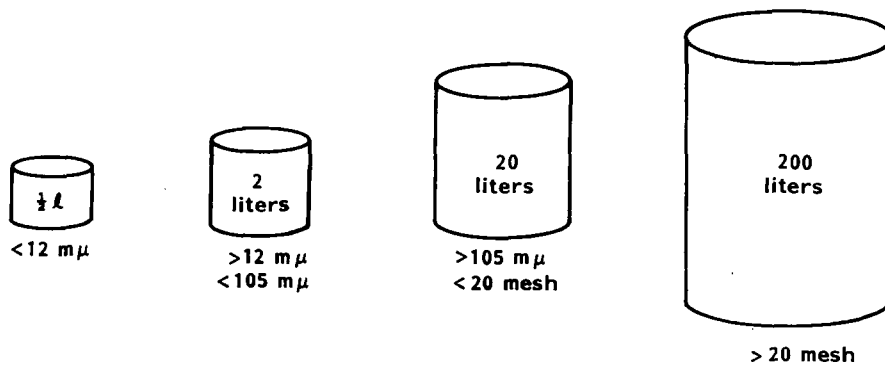

Fig 1 Maximum Container Size in Working Area for Safe Handling of Zirconium

Oxidation Characteristics of Zirconium

The literature on Zr combustion is extensive. A study of the ignition characteristics of the metal and its alloys was published by the Argonne National Laboratory (Ref 3). It was found that the oxidation rate of Zr was independent of pressure, and that it proceeded according to a cubic rate law (see below) over a temp range of 700° to 1200°K. When Zr is heated gradually in air or oxygen, no ignition was observed even when temps of 1600°K were exceeded, but if the heating took place in a inert atm and oxygen was admitted suddenly, ignition would take place readily. The combustion characteristics of untreated and HF treated Zr particles have been studied (Ref 24) and the results for small particles are in agreement with Schnitzlein's work (Ref 3), whose results are plotted in Fig 2. When the burn time is plotted versus the particle diameter on log-log paper, a straight line of slope 1 is observed for particles below 20m μ , and a slope of 2 is observed for larger particles. A slope of 1 is said to describe a "cubic" rate law (ie, one for which the burn rate is proportional to the particle size) and which is said to be kinetically con-

trolled. The slope of 2 describes a "parabolic" rate law, one which is diffusion limited

Ignition temp is a function of particle size as well (Fig 2). Conditions which accelerate oxidation will probably lower the ignition temp and increase the possibility of spontaneous ignition. It was found that Ti had a significant effect on lowering the ignition temp of Zr foils (Ref 3). Such findings suggest ways of enhancing the incendiary fragment properties of Zr. It must be remembered, however, that the ignition temp is not an intrinsic property of the metal but is dependent on the exptl method. For this reason, reproduction of ignition temps by various investigators is rare

The linear log-log plots of reaction rate (in terms of oxygen consumption) versus time show for many alloys a discontinuity, or increase of reactivity. It appears that this transition is associated with the phase transformation in the protective film of Zr dioxide. The initial film formed on Zr is the cubic polymorph of Zr dioxide. After a period of oxidation this transforms to the tetragonal, and finally to the monoclinic (stable) form of Zr dioxide. When certain alloying constituents

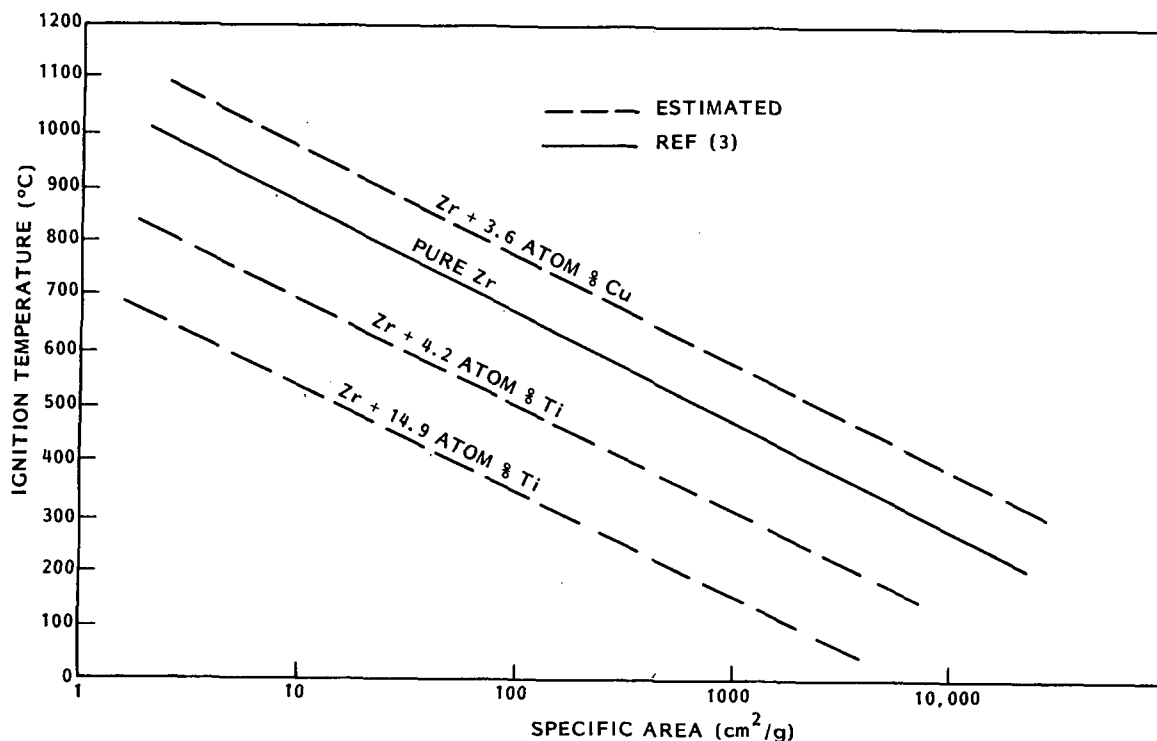

Fig 2 Dependence of Ignition Temperature of Zirconium on Particle Size

which are soluble in α -Zr are added, the oxidation produces a film which consists of the additive metal oxide dispersed in the cubic Zr dioxide. If the ionic radius of the additive ion is sufficiently different from the ionic radius of Zr, the lattice of Zr dioxide will be disturbed. This will decrease the stability of the cubic form, thereby causing the polymorphic transformation to occur at a lower film thickness than is the case with pure Zr. If the alloying constituent is insoluble in α -Zr (ie, if it forms a separate phase), the oxidation film may consist of cubic Zr dioxide and agglomerates of the alloying metal oxide. These separate oxide agglomerates may interfere with the adhesion of the oxide film and so increase the oxidation rate. If the foreign oxide does not interfere with adhesion, the system will behave as if consisted of pure Zr, and therefore will have but a modest reactivity. Examples of soluble alloying metals are Ti, Sn, Pb, and Nb, whereas insoluble alloying agents which promote reactivity are Si, Pt, V, Mo, U, C and B. Insoluble alloying agents which inhibit reactivity are Cu, Co, Ni and Fe

Zirconium as an Incendiary Metal

The reason for the high pyrophoric potential of Zr remains obscure. The matter was touched on in an earlier entry ("Pyrotechnics", Encycl Vol 8), and it was the subject of a report by Hillstrom (Ref 20). There it was suggested that the reason might be due to a combination of factors: its high heat of oxidation, the low oxide density compared with that of the metal and the presence of an unfilled d shell in its electronic structure. In ions of the 1A and 2A groups of the periodic table, the 4s orbital is slightly more stable than the 3d, causing additional electrons to go into the 4s orbital. By the time one reaches the 3b group, the 3d orbital energy dips below the 4s orbital energy, and it remains there for all higher atomic numbers. This crossover of the s and the d orbital energies occurs at the beginning of a transition metal series. Although the s orbitals fill first in groups 1a and 2a, it is the d orbitals that are filled first in transition metals. The outer electronic configuration of Zr^{2+} is $4d^2$ and not $5s^2$. This observation was illustrated by Slater (Ref 1) for Ti, who showed that the ionization potential of the $3d^2$ and the $4s^2$ electrons is indistinguishable, an observation

which is expected to be true for the valence electrons of Zr and Hf as well

The combination of high speed fragment penetration and the exothermic reaction of Zr projectiles provides the triggering mechanism for the destructive release of energy when impacting aircraft fuel and ordnance payloads. The projectile effect on fuel tanks is threefold. First there is the structural damage to the tanks due to fragment penetration, then the high velocity fragments cause hydraulic shock within the fuel tank which in turn can induce additional structural damage to the tanks. Thirdly, the possibility exists that the burning Zr fragments will ignite the jet fuel

Upon impact on the target the Zr alloy components of the projectile fracture into a cluster of fragments which ignite due to shock and friction. The combustion temps vary with fragment size and velocity, but for fine particles they exceed $3400^\circ K$. Extensive tests on mixts of Zr with ignition compds, and determinations of the burn time of the incendiary fragments were reported on by Custard (Ref 2)

The efficacy of Zr, Zr-Sn and of mischmetal incendiary fragments were compared for the Zuni Mk 63 Mod 0 warhead (Ref 7). It was found in arena-type ignition tests that Zr was superior to mischmetal, but that Zr functioned approximately as well as its alloy, Zr-Sn. Wrought Zr was found not to function as well as compressed sponge, but was preferred because of its improved ease of fabrication

In recent years Zr and its alloys have emerged as the principal constituents of incendiary hardware, having displaced Mg in this application. This has been demonstrated in the Air Force programs for the BLU-61 and the BLU-85 configurations. Optimum incendiary effects were exhibited in these applications by Zr sponge compacts

A patent (Ref 27) was issued for the powder metallurgical fabrication of pyrophoric penetrators which incorporate W, Zr and a binder metal (ie, Ni, Fe and/or Co) which compare well with depleted U penetrators

A proprietary incendiary formulation which is suitable for pressing or machining of complex shapes is marketed by Quantic Industries, Inc, San Carlos, Ca, 94070 under the registered trademark QAZ. This system consists of 0.1 -1mm

Zr (70%), 10-30 μ Al spheres (10%), some abrasive and an organic binder. The Company claims that QAZ provides an inexpensive low density liner for certain types of shaped charges. The jet formed by Zr and Hf is comparable with that formed by Cu liners, but has the added property of being chemically reactive with certain types of non-metallic targets, resulting in the release of additional, "free", energy

W.W. Hillstrom (Ref 21) attempted to correlate the pyrophoricity of bulk metals with the kinetic energy at impact on a variety of targets, both projectile and target being characterized by Brinnel hardness. Such a study would be of value in the opinion of this author, if the shock propagation properties of the materials at the moment of impact had been used instead. Hillstrom's findings may be instructive (Table 5):

Table 5
Threshold Pyrophoricity Values
(from Ref 21)

Projectile	Target	Threshold Kinetic Energy, newton-meters
Mischmetal	Dural	5.9
	Mild Steel	1.6
Zirconium	Dural	50
	Steel	18
Titanium	Steel, Armor	5.1

Zirconium in Pyrotechnic Mixtures

Ignition mixts are formulated for specific desired linear burn rates, sensitivity and gas output. Sensitivity relates to questions of safety (static discharge sensitivity, impact and friction sensitivity, autoignition temp, as well as storability, ignitability and hygroscopicity). Gas output determines the suitability of the formulation as a flame agent, as a proplnt (in squibs), and ignitability at high altitudes. In all categories Zr containing formulations have been developed which replace in many applications the traditional BlkPdr and B-KNO₃ mixts. Zr appears to be the best fuel to promote high burn rates in so-called gasless mixts. Hf has not yet been investigated for this purpose, but except for the question of cost and availability, should be even better than

Zr. Variations in burn rate of an order of magnitude have been achieved with Zr mixts, which moreover possess low sensitivity to impact and friction. On the other hand, static sensitivity appears to be higher than that of other types of ignition mixts. Formulations suitable for gasless systems (which have high temp but low altitude dependence) are tabulated in Table 6, while gaseous systems (suitable as squib mixts or as flame agents for proplnt ignition) are listed in Table 7. Variation in performance from the tabulated values is to be expected depending on the particle size and prior history of the Zr as well as the compaction pressure and the technique of binder addition

Systematic replacement of Zr in Zr-Pb chromate delay column mixts with Zr-Ni alloy (Ref 16) has produced burning rates varying from 2.3–0.128cm/sec. Faster burning formulations can be produced, but these are limited in usefulness by their gasiness and the violence of the combustion process. Ellern (Ref 9a) reviewed the early work on the use of Ca chromate in lieu of Ba chromate in Zr containing heat powders. Such formulations have a higher heat output per unit weight provided that the Ca chromate is dehydrated prior to use

A patent was issued for a Zr-fluorocarbon polymer system (Ref 15) which is said to function much like a Mg-teflon system. The claim was made that it burns progressively, leaving behind a coherent incandescent residue or ash. No published tests of this concept was found. It can be shown thermochemically, that depending on stoichiometry, Ti functions with equal energy density in this formulation

Ti hydride/K perchlorate mixts have been found to be good donor materials (Ref 28) when initiated with a bridgewire or mild detonating fuze, affording the possibility of utilization in electric detonators which function with delays ranging from 25 msec to 3 sec. Whereas no fundamental studies have been found on the shock initiation of Zr hydride, its response must be considered comparable with that of Ti hydride for whose shock initiation an excellent study was recently published (Ref 31). Methods for estimating internal energies of pyrotechnic mixts in the absence of shock initiation studies were described by Hardt and Martinson (Ref 22)

Table 6
Composition and Properties of Gasless Ignition Mixtures Containing Zirconium (from Refs 11 & 32)

Ingredients Composition, wt %	Heat of Reaction, cal/g	Burn Rate, cm/sec	Autoignition Temp, °C	Ignitability	Comments
Ti/BaCrO ₄ 37.9/62.1	1204	4.57	—	—	Hot particle ignition; used in gasless delay systems
Zr/BaCrO ₄ 25/75 with 2% nitrocellulose	447	7.62	470, 5 sec	2.22 cal/cm ² at 100 cal/cm ² -sec	Bead material
Zr/MoO ₃ /Cr ₂ O ₃ variable compn	500	10.16	—	—	Cr ₂ O ₃ lowers burn rate
Zr/Fe ₂ O ₃ 65/25/10 celite	478	10.67	220 (DTA)	0.65 cal/cm ² at 100 cal/cm ² -sec	A1A composition; good flame transfer properties; high sensitivity to hot wire ignition
Zr/PbO ₂ 72/28	250	5-50	345 (DTA)	—	Efficient for lighting large propellant mass; high flame temperature
Zr/PbCrO ₄ with 2% dry nitrocellulose	483	38	455, 5 sec	<0.46	Beadmix with potential for replacing primary expls
Zr/Fe ₂ O ₃ /superfloss 41/49/10	500	1.45	—	—	Gasless delay mixture
Zr/Ni/BaCrO ₄ /KClO ₄ 26 / 60 / 14	497	0.17	—	—	As gasless delay mixture; wide temperature stability; wide range of delay time variability; impact sensitivity 56cm
Zr/Ni/BaCrO ₄ /KClO ₄ 5 / 17 / 70.5 / 7.5	—	0.3-0.03	585, 5 sec	—	

Table 7
Standard Ignition Mixtures Containing Zirconium (from Refs 11 & 32)

Ingredients Composition, wt %	Heat of Reaction cal/g	Burn Rate, cm/sec	Theoretical Flame Temp, °K	Autoignition Temp, °C	Ignitability	Comments
Al/Zr/Ba(NO ₃) ₂ /KClO ₄ 34/10/50/5 with 1% binder	1580	3.81	—	—	—	Flat pressure dependence
Al/B/Zr/Ni/KClO ₄	1550	4.57	—	—	—	Replacement for Al/KClO ₄
Zr/KClO ₄ /Graphite 45/47/1	1260	0.3 cm/sec at 0.1 atm	3890	678 (DTA)	0.8 cal/cm ² at 100 cal/cm ² -sec	Bridgewire bead mixture for electric squib
Ditto (30/7.9/binder)	—	1.7 cm/sec at 27 atm	—	—	—	Moderate Brisance (Univ Match XW-17 Al)
Zr/B/KClO ₄	1390	12.7	—	—	—	Boron attenuates brisance
Zr/Ba(NO ₃) ₂ 46.6/53.4	1105	14	4000	215 (DTA)	—	Flash Charge; excellent stability in presence of BlkPr, moisture, double base propellant, ammonia, high altitude
Ti/KClO ₄ (for comparison) 50/50	1805	24.5	3300	—	—	High pressure dependence; thermally stable; similar to Al/KClO ₄ ; impact sensitivity > 240 kg-cm
Zr/NH ₄ ClO ₄ /graphite 65/34/1	1700	—	4600	272, 5 sec	1.73 cal/cm ² at 100 cal/cm ² -sec	Bridgewire bead mix for 1 amp 1 watt squibs; impact sensitivity 218 kg-cm
Zr/KNO ₃ 53/47	1149	0.96	3500	—	—	With polysulfide binder is cast- able igniter material ignitable with hot wire; has low but sustained pressure output

(continued)

Table 7 (continuation)

Ingredients Composition, wt %	Heat of Reaction cal/g	Burn Rate, cm/sec	Theoretical Flame Temp, °K	Autoignition Temp, °C	Ignitability	Comments
Zr/Pb styphnate/ PbO ₂ /gum 19.5/35/45.5/0.8	—	—	—	—	—	For electric ignition; squibs for functioning time of 1msec; reproducible high altitude ignition
ZrH ₂ /Resin/KNO ₃ / Dibutyl Phthalate 32.8/32.8/32.9/1.5	675	0.5	—	360, 3 sec	0.22 cal/cm ² at 100 cal/cm ² -sec	Gas generator-main charge pyrojet igniter; when cast in segments has potential for engine restart
ZrN/Ba(NO ₃) ₃ /KClO ₄ 53.9/16.6/26.5 with 3% ethocel or Teflon	874	0.35 at 0.1 atm 0.142 at 0.07 atm	—	—	336 (DTA)	Low brisance igniter for high altitude applications
ZrNi/KClO ₄ 50/50	1209	—	—	—	—	For initiating main charge mixtures

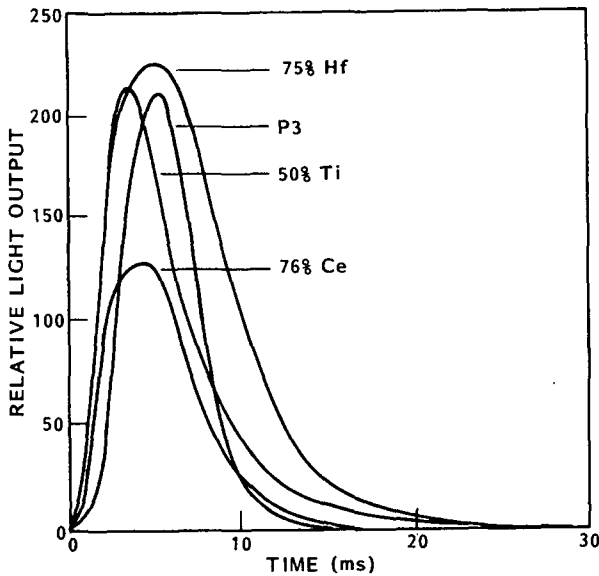

Fig 3 Light Output from Stoichiometric Mixtures of Barium Nitrate with Various Fuels (Ref 14)

The use of Zr and B as well as of Zr and C as gasless intermetallic systems suitable as igniter materials was investigated by Hardt et al (Ref 18)

Edelman, Kaye and Jackson (Ref 10) found that a photoflash formulation containing Hf as a replacement for Al exhibited a greater luminous efficiency on a volumetric basis than did the standard 60/40 K perchlorate/Al mixt, and that Hf could also be used as an alternative to Al in a formulation of the P1 type (Ba nitrate 30%, K perchlorate 30%, Al 40%) and the P3 type (Ba nitrate 57%, Al 43%). An Australian study (Ref 14) on substituting the Al in P3 formulations with stoichiometric mixts of various other fuels produced results as shown in Fig 3 which confirm the earlier Picatinny findings (Ref 10)

Zirconium as a Propellant Fuel

Addition of metal powders to proplnts increases the combustion temp and therefore the specific impulse (I_{sp}). Al continues to be the principal candidate while research in Zr as an additive has continued. Zr containing rocket proplnts have been of interest in applications which require a high volumetric specific impulse (ρI_{sp}). Research has emphasized means of overcoming the low burning efficiency of

Zr. There are some indications that Zr/Al mixts give a higher specific impulse efficiency than proplnts containing only Zr (Ref 23). If the pay-off were sufficient, or if the combustion efficiency could be enhanced by appropriate means, Zr might appear attractive. It seems, however, that the inherently great risks of admixture of fine Zr to oxidizing proplnts argues against its use, and may be the reason why the practical application of this concept awaits realization. Recent work has shown that the hazard is reduced when a dehydrated Zr is used as opposed to a leached powder (Ref 35). A computer program has been written which predicts the combustion efficiency of Zr when it is a proplnt additive, giving the relationship between burn time, oxidizer type and partial pressure thereof, and Zr particle size (Ref 25). No data were found on the performance of Hf as a proplnt additive

Miscellaneous Pyrotechnic Applications for Zirconium

Photoflash Bulbs

In conventional combustion flash lamps, the combustion of Zr in oxygen is utilized to generate light having a blackbody temp of about 4600°K. Higher blackbody temps can be achieved if more reactive systems are used which have reaction products of high thermal stability. The reaction of Al and Zr with oxygen, fluorine and fluorine compounds have been investigated (Ref 9). For reasons of technology and safety, the oxygen pressure in flash bulbs must be as small as possible. During the combustion of Zr in oxygen as much as 1700 lumenseconds/cm³ atm O₂ are emitted, while Al will generate only 1000 lumenseconds/cm³ atm O₂. Therefore, even though because of its higher atomic weight, Zr emits less light per unit mass than does Al, Zr is preferred because of its higher light intensity. The stability of Zr oxide is a strong function of pressure because the dioxide is unstable at elevated temp with respect to the monoxide. This is why the combustion temp of Zr is limited to 4000°K at 0.5 atm O₂, 4500°K at 3 atm O₂, and 5000°K at 15 atm O₂. Because the temp of Hf oxide at the same pressure is about 500 degrees higher, the flame temp of Hf is also about 500 degrees higher than that of Zr

Table 8 lists a comparison of the color temps

Table 8
Maximum Quantity of Light Emitted by Flashbulbs

Reaction	Std Color Correction	Color Temperature °K	Ref
Al + O ₂	—	4000	9
Zr + O ₂	yes	4631	19
Zr + NF ₃	—	4600	9
Zr + F ₄ N ₂	—	4700	9
Zr + OF ₂	—	4300	9
Zr + O ₂	no	4294	19
Hf + O ₂	no	4670	19
Zr + O ₂	—	4883 peak temp	19
Hf + O ₂	—	5235 peak temp	19

of various flash lamp systems which supports the preceding argument (Ref 19)

Firestarters

A patent has been issued for the use of Zr compacts as firestarters (Ref 26). The idea was to ignite compacts which are in contact with a flame agent and to rely on air oxidation to provide a sustained source of heat for the lighting of camp fires and charcoal. The burn time was said to vary, depending on the design, from 20 to 150 minutes at average temps of 1100°K. Zr and Hf are said to have comparable and superior burn times compared with Ti

Written by: A. P. HARDT

Lockheed Missiles and Space Company, Inc

Refs: 1) J.C. Slater, "Quantum Theory of Matter", McGraw-Hill, NY (1951), 145
 2) G.H. Custard, G. Francis, and W. Schnackenberg, "Small Arms Incendiary Ammunition", Frankford Arsenal R-1407-1 (Dec. 1956) (AD 159 322)
 3) J.G. Schnitzlein et al, "Ignition Behavior and Kinetics of Oxidation for Reactor Metals U, Zr, Pu, Th and Binary Alloys of Each", Argonne National Laboratory ANL-5974, Contract W-31-109-Eng-38, (1959)
 4) R. Hultgren et al, "Selected Values of Thermodynamic Properties of Metals and Alloys", J. Wiley and Sons, NY (1963). Also see the Supplement thereto, University of California Press, Berkeley (1972)
 5) Anon, Military Pyrotechnic Series: Part III, "Properties of Materials Used in Pyrotechnic Compositions", AMCP 706-187 (October 1963)
 6) C.F. Wicks and F.E. Block, "Thermodynamic

Properties of 65 Elements", US BuMines Bull 605 (1963)
 7) C.T. Johnson, "Fuel Fire Starting Ability of Zr (VI)", Ref 22 this article
 8) Landolt-Boernstein, "Numerical Values and Functions", Vol 4, Pt 2C (1965)
 9) L.M. Nijland and J. Schroeder, "The Generation of Light by Chemical Reactions in Flashlamps", Proceedings of the Eleventh International Symposium on Combustion, 1277-1284 (1966)
 9a) H. Ellern, "Military and Civilian Pyrotechnics", Chemical Publishing Co, Inc, NY (1967), 282-284
 10) D.J. Edelman, S.M. Kaye and B. Jackson, "Evaluation of New Photoflash Formulations", PATR 3382 (1967)
 11) W.E. Robertson, "Igniter Materials Handbook", Bermite TR690, Contract No. N00017-68-C-4426 (1969)
 12) G.H. Bulmer, "Recommendations for Safe Handling of Zirconium and Zirconium Alloys", UKAEA 1969, AMSB-S-S-167 (1969)
 13) J.W. Stamper and E. Chin, "Zirconium", US BuMines Bull 650, "Mineral Facts and Problems" (1970)
 14) R.H. Weldon et al, "Evaluation of the Change in Performance of Pyrotechnic Flash Units by the Substitution of the Aluminum Fuel by Hafnium, Cerium, Titanium and Zirconium", Tech Memo CPD163, Australian Defense Scientific Service (August 1970)
 15) H.R. Waite, "Incendiary Composition Containing a Metallic Fuel and Solid Fluorocarbon Polymer", USP 3565706 (February 23, 1971)
 16) G.M. Hensel et al, "Evaluation of Metal Fuels for Use in Pyrotechnic Delays", Part II, WRE Technical Memorandum 529 (WR&D), Australian Defense Scientific Service

(November 1971) 17) Anon, "Guide for Fire and Explosion Prevention in Plants Producing and Handling Zirconium", National Fire Protection Association (NFPA), Bull No 482M (1974) 18) A.P. Hardt et al, "Propagation of Gasless Reactions in Solids", *Combustn & Flame* 21 (No 1) (1973), 77-97 19) B.T. Buzalski et al, "Hafnium Fuel for Photoflash Lamps", *J of Illuminating Engineering Society* 2 (July 1973) 362-5 20) W.W. Hillstrom, "Formation of Pyrophoric Fragments", *BRL MR 2306* (1973), (AD 765447) 21) W.W. Hillstrom, "Thresholds for the Initiation of Pyrophoric Sparking", Paper No 22, Proceedings of the 4th International Pyrotechnics Seminar, The Denver Research Institute (July 1974) 22) A.P. Hardt and R.H. Martinson, "Initiation of Pyrotechnics Mixtures by Shock", Paper No 53, Proceedings of the Eighth Symposium on Explosives and Pyrotechnics, The Franklin Research Institute, Philadelphia, Pa (Feb 1974) 23) J.L. Fields and J.D. Martin, "The Combustion of Zirconium in Rocket Motors Containing High Density Impulse Propellants", Vol III, 12th JANNAF Combustion Meeting, CPIA Publication 273, (December 1975), 159-166 24) M.K. King and J.M. Semple, "Ignition and Combustion of Zirconium Particles Used in Solid Propellant Formulations", Vol II, *ibid*, 221-244 25) J.D. Martin et al, "High Density Zirconium Propellants", Proceedings of the 1975 JANNAF Propulsion Meeting (October 1975) 26) R.W. Griffin, "Fire Starter and Method" USP 3927993 (Dec 23, 1975) 27) G.A. Hayes, "Pyrophoric Penetrator", USP 3946673 (30 Mar 1976) 28) E.A. Day and P.B. Ritter, "Two All Non-Primary Explosive Time Delay Detonation Devices", Proc of the Fifth International Pyrotechnic Seminar, Denver Research Institute (July 1976), 74-84 29) Anon, "Hafnium", Promotional Brochure, Teledyne Wah Chang Albany (no date) (no number) 30) Anon, Internal Memorandum, Teledyne Wah Chang Albany (July 26, 1978) 31) L.M. Lee & A.C. Schwarz, "Shock Compaction of a Porous Pyrotechnic Material", Proc of the Seventh Int Pyrotechnic Seminar, Denver Research Institute, Vol I (July 1980), 304-21 32) T.P. Goddard, "High Deflagration Rate Igniter Technology Applications", Contract MDA 903-79-C-0090 Mod P 00003, Final Report (15 May 1980) 33) "Hafnium", Kirk-Othmer

Encyclopedia of Chemical Technology, 3rd Ed, Vol 12, J. Wiley & Sons, NY (1980)

34) Anon, "JANAF Thermochemical Tables", Dow Chemical Company, Midland, Mich 48640 (1975) 35) Teledyne Wah Chang Albany, Inc, private communication (1980)

Acknowledgement:

The author thanks Teledyne Wah Chang Albany, Inc, for the use of the company's files on ordnance applications of Zr and Hf, and Mr. D.P. Tetz for his helpful assistance

Zirconium Borohydride (Zirconium Tetrahydroborate). $Zr(BH_4)_4$; mw 150.5; volatile pyrophoric cryst; mp 28.7° ; bp 123° (extrapolated); d 1.13g/cc. Prepn is by reacting Zr tetrachloride with Li borohydride - the yield is 77%. Accdg to Gaylord (Ref 4) the compd is spontaneously flammable in air

Refs: 1) Gmelin, Syst No 42 (1958) 2) *Ibid*, Syst No 42, suppl series, Vol 10 (1973)

3) D.T. Hurd, "An Introduction to the Chemistry of the Hydrides", J. Wiley, NY (1952), 164-65 4) N.G. Gaylord, "Reduction with Complex Metal Hydrides", Interscience, NY (1956), 58 5) J.R. Gibson & J.D. Weber, "Handbook of Selected Properties of Air- and Water-Reactive Materials", Naval Ammo Depot RDTR 144, Crane (1969), 93 6) K.N. Semenenko et al, "Covalent Tetrahydroborates", *RussChemRev* 42 (1), 3-25 (1973) & *CA* 78, 10544 (1973)

Zirconium Carbide. See in Vol 1, A83-L and the following *Addnl Ref*: Anon, "Fire Protection Guide on Hazardous Materials-7th Ed", Natl Fire Protection Assn, Boston (1979), 441M-447 [Zr carbide in the form of a fine powder is spontaneously flammable in air]

Zirconium Dibromide. $ZrBr_2$; mw 251.05; pyrophoric blk pdr; mp $> 350^\circ$ (decompn) Decompd by w. Prepn is by heating the tribromide in vacuo at 390° . The compd is spontaneously flammable in air, and reacts vigorously with oxidizing materials

Refs: 1) J. Kleinberg et al, "Inorganic Chemistry", Heath, Boston (1960), 498 2) J.R. Gibson & J.D. Weber, "Handbook of Selected

Properties of Air- and Water-Reactive Materials", Naval Ammo Depot RDTR 144, Crane (1969), 64

Zirconium Fluoride. See in Vol 6, F150-R

Zirconium Hydride. ZrH_2 (?); mw 93.24 (?); grey-blk pdr, does not form a well defined compd; it exists in five cryst phases, the ϵ phase is a face-centered tetragonal cryst lattice that approximates the formula closely; mp, air auto-ign temp of 270° ; d 5.6g/cc. V sl sol in HF or concd acids. Prepn is either by heating Zr with H_2 , forming the metal in the presence of H_2 , reduction of zirconia with Ca hydride in the presence of H_2 at $600-1000^\circ$, or by the combstn of Zr in H_2

The compd is ignitable with an open flame. The hydride is much safer to handle and ship in a dry, finely divided state than the metal itself. This greater inertness also shows itself in a lower ignition sensitivity and a slower burning rate than powdered Zr (Ref 7)

Ref 8 suggests its use in an expl primer compn which is claimed to be insensitive to mechanical shock. This formulation contains Ba nitrate (60), an Al/Mg alloy (15), Pb oxide (12), Zr hydride (10) and B (3%). Greiner and Courtney (Ref 9) invented a hybrid proplnt consisting of Zr hydride as fuel and cryst perchloric acid as oxidizer. Thus, a system contg Zr hydride (67.2) and cryst perchloric acid (32.8%) is reported to have a calcd d of 3.21g/cc, a shifting specific impulse of 203.2 secs, and a shifting volumetric specific impulse of 23.6 lb-sec/cu inch. Kaufman and Stang (Ref 12) claim to have invented a solid proplnt contg the hydride. Zr hydride (20-50), AN (40-60) and perfluoropropene vinylidene fluoride rubber (5-20 wt %) are consolidated to form the proplnt which exhibits 98.9% theoretical max d. The inventors report a firing pressure of 1056 psi, an impulse of 237 lb/sec, a burning rate of 0.545 inches/sec and a specific impulse of 185 secs

Zr hydride is also used in pyrot formulations. Ellern (Ref 7, p 354) reports on a conductive primer mixt contg fine Zr (15), Zr hydride (30), Pb dioxide (20), Ba nitrate (15) and PETN (20%), while both he (p 379) and Weingarten & Knapp (Ref 3) detail the following formula for a pressed-on first fire for illuminating flares: Si (20),

Zr hydride (15), Tetranitrocarbazole (10), Ba nitrate (50), and binder (5%)

Sittig (Ref 15) reports no local or long term toxic effects from exposure to either Zr or its hydride. However, the Federal standard for max exposure to Zr compds is 5mgs/cu meter (as Zr)

The US Military specification covering the hydride is MIL-Z-21353 (9 June 1959) (Ref 4) which delineates both chemical and physical requirements (Table 1)

Table 1
Zirconium Hydride Specification Requirements

Property	% Min	% Max
Zr plus Hf ^a	99.5	-
H_2 ^b	1.85	2.10
Avg particle diam ^c	-	< 10 microns

Footnotes to Table 1:

- a - Gravimetrically as Zr oxide
b - Gravimetrically by oxidn to w, absorbing on Mg perchlorate, and weighing
c - In accordance with MIL-STD-707

Refs: 1) Gmelin, Syst No 42 (1958) 2) D.T. Hurd, "... Hydrides", J. Wiley, NY (1952), 184 3) G. Weingarten & C.A. Knapp, "Investigation of Torpedo Igniter Mark VI Models 2, 3 and 4", PATR 2180 (1955) 4) Anon, "... Zirconium Hydride", MIL-Z-21353 (NOOrd) (9 June 1959) 5) Anon, Engrg Des Hndbk, "Military Pyrotechnics Series, Part Three - Properties of Materials Used in Pyrotechnic Compositions", AMCP 706-187 (1963), 335 6) Sax (1968), 1249 7) Ellern (1968), 333 8) Anon, "Shock-Resistant Explosive Primer", FrP 1599961 (1970) & CA 74, 128372 (1971) 9) L. Greiner & W.G. Courtney, "Fuel Systems and Oxidizers", USP 3705495 (1972) & CA 79, 7571 (1973) 10) Merck (1976), 1311 (No 9842) 11) CondChemDict (1977), 944 12) H.M. Kaufman & P.L. Stang, "High Density Impulse Solid Propellant", USP 4012244 (1977) & CA 86, 173786 (1977) 13) S.K. Dolukhangan et al, "Combustion of Transition Metals in Hydrogen", DoklAkadNaukSSSR 231 (3), 675-78 (1976) & CA 86, 123835 (1977) 14) Bretherick (1979), 980 15) M. Sittig, "Hazardous and Toxic Effects of Industrial Chemicals", Noyes Data Corp, Park Ridge (1979), 458-60

Zirconium-Lead Alloys. These alloys, contg from 10 to 70% Zr, are claimed to pulverize and ignite on impact

Refs: 1) P.P. Alexander, USP 2611316 (1952) & CA 47, 5686 (1953) 2) Bretherick (1979), 1140

Zirconium-Nickel Alloys. Zr/Ni:70/30 (Type I) and 30/70 (Type II); silvery white to grey cubic crystn pdrs; d, 7.20g/cc (Type I), 8.10g/cc

Table 1

Specification Requirements for Type I and Type II
Zr-Ni Alloys

Property	Type I	Type II
Ca, % max ^{-a}	0.15	0.15
Fe, % max ^{-b}	0.20	0.20
Al, % max ^{-c}	0.15	0.15
S, % max ^{-d}	0.01	0.01
Total Zr and Ni, % min ^{-e}	96.0	96.0
Zr, % ^{-f}	70.0±4.0	30.0±4.0
Ni, % ^{-g}	30.0±4.0	70.0±4.0
Moisture, % max ^{-h}	0.20	0.20
Granulation, ⁻ⁱ		
Min % passing thru a US No 200 sieve (75 microns)	99.5	99.5
Min % passing thru a US No 325 sieve (45 microns)	97.0	97.0
Avg particle diam, microns ^{-j}	5±3.0	5±3.0

Footnotes to Table 1:

- a - By redox titration using 0.1N K permanganate titrant
 b - Spectrophotometrically at 470 millimicrons by measuring the absorbance of the color developed by addn of K thiocyanate to a sample aliquot
 c - Gravimetrically as Al oxide
 d - By redox titration using 0.03N K iodate titrant to a starch-iodine end point
 e - By addn of the individually detd Zr and Ni percentages
 f - Gravimetrically as the cupferron ppt
 g - Gravimetrically as the dimethylglyoxime ppt
 h - Gravimetrically after drying a 2g sample at 105±5° and cooling in a desiccator
 i - Gravimetrically using a 10g sample after sieving, w-washing and drying to constant wt at 105°
 j - In accordance with MIL-STD-1233, method 100

(Type II); resistant to acids and alkalis. Prepn is by fusion of the elements (Refs 1 & 4)

Their primary use has been as fuels in pyrot delay formulations (see under "Delays and Fuzes" in Vol 8, P512-R to P515-L & Table 9), where they replaced the earlier use of separate powders of Zr and Ni. Because of changes in burning rate on storage and at varying operational temps exhibited by delay compns contg individual Zr and Ni powders, and because treatment to resist corrosion of both the Zr and Ni did not alleviate the difficulties, their use was discontinued, and attention was focused on the alloys of Zr and Ni as a potential fuel. The alloys were less flammable and hazardous to use than fine Zr pdr, and eliminated the need for catalytic Ni pdr which must be manufd under very carefully controlled conditions (Ref 3)

A wide range of burning times could be attained in Ba chromate/alloy/K perchlorate formulations by changing the percentages of the ingredients, and by varying the ratio of Zr and Ni in the alloy. Addnl experience with these compns indicated a lengthening of burning times with extended storage, especially in the presence of moisture. To eliminate this trend, the alloy was usually dichromated to decrease its reactivity to moisture. This treatment, although it lessened the reactivity of the alloy, did not entirely eliminate the change in burning times with extended storage (Refs 2 & 3)

The US military specification covering powdered Zr-Ni alloy is MIL-Z-11410B (12 Feb 1968) (Ref 4). The following requirements, shown in Table 1, apply to 70/30 Zr-Ni (Type I) and 30/70 Zr-Ni (Type II) alloys

Refs: 1) Anon, Engrg Des Hndbk, "Military Pyrotechnics Series, Part Three-Properties of Materials Used in Pyrotechnic Compositions", AMCP 706-187 (1963), 337 2) D. Zauder et al, "Development of Zirconium-Nickel Alloy Delay Powder for M204A1 Hand Grenade Fuzes", PATR 2228 (1965) 3) G. Weingarten, "Pyrotechnic Delay Systems", in F.B. Pollard & J.H. Arnold, Jr, Eds, "Aerospace Ordnance Handbook", Prentice-Hall, Englewood Cliffs, NJ (1966), 270-74 4) Anon, "... Zirconium-Nickel Alloy, Powdered", MIL-Z-11410B (12 Feb 1968)

Zirconium Nitrate. See in Vol 8, N40-L

Zirconium Oxide Hydroxide-Perchlorate.

$Zr(OH)_2 \cdot 9ZrO(ClO_4)_2$, $Cl_2 H_2 O_{8.3} Zr_{1.0}$; mw 2321.13; v deliq, odorless cryst; mp, decomps below 100° . Sol in benz, ethanol, eth, chl_f and CCl_4 . Prepn is by heating perchloric acid with an excess of Zr hydroxide on a w bath, and then cooling the satd soln. When heated quickly, the compd explds with great brisance
 Ref: Mellor 2, 403 (1946)

Zirconium Picrate. See in Vol 8, P283-R

Zirconium Sulfate. $Zr(SO_4)_2 \cdot 4H_2O$; mw 355.41; hydr cream white rhombic cryst; mp, converted to the monohydrate at 100° , to the anhydr form at 380° , with decompn at 410° ; d 3.22g/cc at 16° . V sol in w; insol in ethanol. Prepn is by treating Zr oxychloride with hot concd sulfuric acid

Ripley (Ref 1) noticed the anti-caking effect of the sulfate on powdered Na nitrate used as oxidant in pyrot illuminating flares. We quote: "Most spectacular of these contaminants was the effect of zirconium sulfate. On drying, sodium nitrate contaminated with zirconium sulfate formed a kind of "growth" on the surface that was unlike anything observed with either pure sodium nitrate or with any of the other contaminants. Chemical analysis showed the presence of about 0.15% zirconium. X-ray diffraction studies revealed no difference in the pattern of the zirconium sulfate doped sodium nitrate and the control sodium nitrate. However, differential thermal analysis showed a very large endotherm at $150^\circ C$. The dried and ground material had a dull, chalky appearance. It formed no lumps after standing for six months and remained free-flowing and powdery. Four experimental Mark 24 Flares were prepared and their burning characteristics compared with four control candles. The average burning time of the four control flares was 190 seconds, the average candlepower was 1,900,000cp integrated over the full burning time, and the candlepower efficiency was 53,000cp-sec/g. The average burning time of the four experimental candles made with zirconium sulfate doped sodium nitrate was 164 seconds, the average candlepower

was 1,961,000cp, and the candlepower efficiency was 49,000cp-sec/g. Thus, as might have been anticipated, the doped candles burned faster and at a lower efficiency than the control candles."

As a follow-up to this work, Biggs (Ref 4) reports that, "... Zirconium sulfate doped sodium nitrate was investigated to lower the activation energy of sodium nitrate to cause more rapid decomposition, and reduce the hygroscopicity. From experimental data, zirconium sulfate doped sodium nitrate does neither of the above ... it does not increase the burning rate of illuminating compositions via a catalytic mechanism. It may affect their burning rate by adsorbing the binder and decreasing the binder's effective binding properties. ... Two percent zirconium sulfate doped sodium nitrate can be processed to low-micron sizes. The processed material still has anti-caking properties ..."

Zirconium sulfate, in amts of from 1.0 to 7.5%, has also been used as an ingredient of a thickening agent added to base expls to form blasting slurries or gels which are w-resistant (Refs 2 & 3)

Refs: 1) W. Ripley, "The Effect of Selected Contaminants on the Hygroscopicity of Sodium Nitrate", Naval Ammo Depot RDTR 140, Crane (1969), 11 & 12 2) F.J. Klinia & J.D. Duncan, "Forming in Place a Gelled Suspension Explosive", USP 3676236 (1972) & CA 77, 154629 (1972) 3) B.W. Oettmeier & J.S. Porter, "Gas Entrained Aqueous Gel Explosive", USP 3783053 (1974) & CA 80, 122955 (1974) 4) W.T. Biggs, "Doping with Zirconium Sulfate", Naval Ammo Depot RDTR 244, Crane (1973) & CA 80, 122926 (1974) 5) Merck (1976), 1312 (No 9848) 6) CondChemDict (1977), 945 7) ChemRubberHndbk (1978), B-178

Z-Salz, Z-Stoff C and Z-Stoff N. Aq solns of Na or Ca permanganates used as catalysts in liq rocket proplnts to assist the decompn of hydrogen peroxide which served as a source of oxygen
 Refs: 1) B.T. Fedoroff et al, "Dictionary of Explosives, Ammunition and Weapons (German Section)", PATR 2510 (1958), 264 2) R. Meyer, "Explosives", Verlag Chemie, NY (1977), 358

A

- A (expl) 1 A1
- AA same as Antiaircraft 1 A461
- A1 (roundkol) 1 A1
- A (series rockets) 1 A1
- A1 (monobel) 1 A1
- A2 (monobel) 1 A1
- A4 (rocket) 1 A1
- A6 (fuseheads) 1 A1
- A9/A10 (guided missile) 1 A1
- Abbeites 1 A1
- Abbreviations 1 A1
- Abel & Dewar smokeless proplnt 1 A1
- Abel (deton) equation of state 4 D271
- Abelite 1 A2
- Abelite No. 1 1 A2
- Abelli, Modesto 1 A2
- Abelli proplnt 1 A2
- Abel powder 1 A1
- Abel, Sir Frederick August 1 A1
- Abel smokeless proplnt 1 A2
- Abel's researches on guncotton 1 A2
- Abel's test 1 VII, A2
- Aberdeen chronograph see Aberdeen screen 3 C306
- Aberdeen proving ground 1 A2
- Abietates 1 A2-A4
- Abietic acid 1 A2-A3
- Abietic acid and derivatives 1 A2-A4
- abietic acid 1 A2-A3
- abietic acid, diazido derivs 1 A3
- abietic acid, organic derivs 1 A3
- abietic, azido derivs 1 A3
- dinitroabietic acid 1 A3
- polynitro derivs of abietic acid 1 A3
- trinitroabietic acid 1 A3
- Abietic acid, diazido derivs 1 A3
- Abietic acid, organic derivs 1 A3
- Abietic, azido derivs 1 A3
- Ability to propagate detonation (test) 1 VII
- Ablation 1 A4
- Abnormal temp testing of proplnts 1 A4
- Abonachit 2 1 A4
- Abrasive 1 A4
- Absolute method of measurement of power of expls see Power of expls measurements 1 XX; 8 P364-P366
- Absolute rate theory 1 A4
- Absolute temp of expln 2 B105
- Absorbent 1 A5
- Absorbent materials for liquid expls see Oxyliquit 8 O62-O63
- Absorbent materials for nitrogen oxides 1 A5
- Absorbent materials from potatoes 1 A5
- Absorbent materials in Dynamites see Dope 5 D1531-D1532
- Absorbent materials to control exudation 1 A5
- Absortimeter 1 A5
- Absorption 1 A5-A6
- Absorption coefficient see Coefficient d'absorption de NC 3 C389
- Absorption, electronic see Absorption spectroscopy 1 A6
- Absorption of moisture by expls, proplnts and pyrots 1 VII, XVI
- Absorption spectroscopy 1 A6
- Absorption towers or columns 1 A7
- packed tower 1 A7
- plate tower 1 A7
- spray towers 1 A7
- AC same as Acetyl cellulose 1 A55-A56
- AcAn see Diacetoxytetrazanonane 5 D1118-D1119
- Acapnia 1 A7

- Acardite or akardite 1 A7–A11
 acardite I 1 A7–A8
 acardite II 1 A8
 acardite III 1 A8–A9
 acardites, analytical procedures 1 A9–A11
- Accelerometers 1 A11
- Accensione 1 A11
- Acceptable expls 1 A11
- Accessibility 1 A11
- Acciaio 1 A11
- Acciaio fuso 1 A11
- Accidental explns in process industry plants 1 A11
- Accidental scientific discoveries 1 A11
- Accidents in industry 1 A11–A12
- Accumulators 1 A12
- Accuracy life 1 A12
- Accuracy tests of small arms ammo 1 A12
- Acenaphthene and derivs 1 A12–A13
 acenaphthene-4-diazonium chloroaurate 1 A12
 acenaphthene picrate 1 A13
 nitroacenaphthenes 1 A13–A14
- Acetal, analytical procedures 1 A13
- Acetal and derivs 1 A13
- Acetal compds of pentaerythritol 1 A14
- Acetaldehyde, analytical procedures 1 A15
- Acetaldehyde and derivs 1 A14–A15
 paraldehyde 1 A14
- Acetaldehyde, azido deriv 1 A15
- Acetaldehyde-diethylacetol 1 A13
- Acetaldehyde-nitrogen dioxide mixts 1 A15
- Acetaldehydeoxime 1 A15–A16
- Acetaldehydepicrylhydrazone 1 A15
- Acetaldehyde superoxide see Diethylidene diperoxide 1 A15
- Acetaldol and derivs 1 A14
 acetaldol, analytical procedure 1 A15
- Acetaldoxime and derivs 1 A15–A16
 acetaldoxime, analytical procedures 1 A16
 acetaldoxime, azido deriv 1 A16
 mononitroacetaldoxime 1 A16
 nitroacetaldoxime, anhydride 1 A16
- Acetol solvent 1 A14
- Acetamide and derivs 1 A16–A17
 acetamide, analytical procedures 1 A16
 acetamide, azido deriv 1 A16
 dinitroacetamide 1 A17
 mononitroacetamide 1 A16
 trinitroacetamide 1 A17
- Acetamidoanisole and derivs 1 A17–A18
 dinitroacetamidoanisole 1 A17
 mononitroacetamido anisole 1 A17
 trinitroacetamidoanisole 1 A17–A18
- Acetamidobenzene see Acetanilide 1 A22–A24
- Acetamidobenzenediazonium hydroxide and derivs 1 A18
- Acetamidodiphenylether and derivs 1 A18–A19
 dinitroacetamidodiphenylether 1 A18
 mononitroacetamidodiphenylether 1 A 18
 tetranitroacetamidodiphenylether 1 A18
- Acetamidofuran and derivs 1 A19
 3,5-dinitro-2-acetamidofuran 1 A19
- Acetamidoguanidine and derivs 1 A19
 1-acetamidomethylhexamine nitrate 1 A19
 N-acetamido-N'-nitroguanidine 1 A19
- Acetamidonaphthalene and derivs 1 A19–A20
 dinitroacetamidonaphthalenes 1 A20
 mononitroacetamidonaphthalene 1 A20
 trinitroacetamidonaphthalenes 1 A20
- Acetamidophenetole and derivs 1 A20
 dinitroacetamidophenetole 1 A20
 mononitroacetamidophenetole 1 A20
 trinitroacetamidophenetole 1 A20
- Acetamidophenol and derivs 1 A20–A27
 acetamidophenol 1 A20
 3-azido-2,6-dinitro-4-acetamidophenol 1 A21
 dinitroacetamidophenol 1 A21
 mononitroacetamidophenol 1 A21
 trinitroacetamidophenol 1 A21
- 5-Acetamido-1H-tetrazole 1 A21

- Acetamidotoluene and derivs 1 A22
acetamidotoluene 4-acetamidotoluene-4-
diazoniumhydroxide 1 A22
dinitroacetamidotoluenes 1 A22
mononitroacetamidotoluenes 1 A22
2,4,6-trinitro-3-acetamidotoluene 1 A22
- 4-Acetamidotoluene-4-diazoniumhydroxide 1 A22
- Acetamidotriazole and derivs 1 A22
4-acetamido-asym-triazole 1 A22
- Acetamido-6-amino-uracil 1 A17
- Acetanilide and derivs 1 A22–A24
acetanilide 1 A22
acetanilide, analytical procedure 1 A22
acetanilide, azido derivs 1 A23
dinitroacetanilides 1 A23
mononitroacetanilides 1 A23
nitronitrosoacetanilides 1 A23
2,3,4,6-tetranitroacetanilide 1 A24
2,3,4,6-tetranitro-N-nitroacetanilide 1 A24
trinitroacetanilides 1 A24
- Acetaniside same as Acetamidanisole 1 A18
- Acetates 1 A27–A29
ammonium acetates 1 A27–A28
calcium acetate 1 A28
cellulose triacetate see Acetyl
celluloses 1 A55–A56
dipotassium nitroacetate 1 A27
lead aceto-bromate to Na perchlorate 1 A29
sodium acetate 1 A29
- Acetatopentammine cobalt (III) nitrate 1 A24
- Acetic acid amide 1 A16
- Acetic acid and derivs 1 A25–A27
acetic acid, analytical procedure 1 A25–A26
acetic acid, azido deriv 1 A27
acetic acid, diazido deriv 1 A27
nitroacetic acid 1 A27
- Acetic anhydride and derivs 1 A29–A31
acetic anhydride 1 A29
acetic anhydride, analytical procedures 1
A30–A31
acetic anhydride, diazido deriv 1 A31
- Acetins and derivs 1 A31–A33
acetins, analytical procedures 1 A32–A33
dinitroacetin 1 A33
monacetin 1 A31
- Acetins and derivs (cont'd)
mononitrodiacetin 1 A33
triacetin (TA) 1 A31
- Acetol 1 A33
- Acetone, analytical procedures 1 A35–A39
- Acetone and derivs 1 A33–A35
- Acetoneazidoacetylhydrazide 1 A39
- Acetone, azido deriv 1 A39
- Acetone-[4-bromophenylhydrazone]-peroxide
1 A39–A40
- Acetone compds 1 A40
- 5-Acetonehydrazone- α (1H)-tetrazole 1 A40
- Acetone insoluble test 1 A40
- Acetone, nitration 1 A40
- Acetone, nitro derivative 1 A40
- Acetone, ozonization 1 A41
- Acetone peroxides 1 A41–A45
diacetone diperoxide 1 A41–A42
triacetone triperoxide 1 A42–A45
- Acetonitrile and derivs 1 A45–A46
acetonitrile, azido deriv 1 A45
dinitroacetonitrile 1 A45
mononitroacetonitrile 1 A45
trinitroacetonitrile 1 A46
- Acetonylacetone and derivs 1 A46
- Acetonyltetrazoles and derivs 1 A46–A47
acetonylazidoditetrazole 1 A47
acetonylazidotetrazole 1 A47
- Acetophenone and derivs 1 A47–A49
acetophenone, azido derivs 1 A47–A48
acetophenone-(4-bromophenylhydrazone)-
peroxide 1 A48
5-acetophenonehydrazone- α (1H)-tetrazole
1 A48
acetophenoneperoxide dimeric 1 A48
dinitroacetophenones 1 A48
mononitroacetophenones 1 A48
trinitroacetophenones 1 A48
- Acetophenoneoxime and derivs 1 A48
acetophenoneoxime, azido deriv 1 A49
dinitroacetophenoneoximes 1 A49
mononitroacetophenoneoximes 1 A49

- Acetotetrazacyclooctane and derivs 1 A49–A50
1-aceto-3,5,7-trinitro-1,3,5,7-tetrazacyclooctane 1 A49–A50
- Acetotriazacyclohexane and derivs 1 A50
1-aceto-3,5-dinitro-1,3,5-triazacyclohexane 1 A50
- Acetoxime and derivs 1 A50–A51
acetoxime, azido deriv 1 A51
mononitroacetoxime 1 A51
- Acetoxydiphenylamine and derivs 1 A51
dinitroacetoxydiphenylamine 1 A51
tetranitroacetoxydiphenylamine 1 A51
trinitroacetoxydiphenylamine 1 A51
- 1-Acetoxy-7-ethoxy-2,4,6-trinitro-2,4,6-triazahexane 1 A51
- 1-Acetoxyethyl-3,5-dinitro-1,3,5-triazacyclohexane 1 A52
- 1-Acetoxyethyl-3,5,7-trinitro-1,3,5,7-tetrazacyclooctane 1 A52
- Acetoxynaphthalene and derivatives 1 A52–A53
2,4,5,7-tetranitro-1-acetoxynaphthalene 1 A52
- Acetoxytriazheptane and derivs 1 A53
1-acetoxy-2,4,6-trinitro-2,4,6-triazheptane or MSX 1 A53
- Acetylacetone and derivs 1 A53–A54
acetylacetone peroxide, polymer 1 A53–A54
N-acetylamidomethylhexamethylenetetramine mononitrate or H₂ 1 A54
chromylacetylacetone 1 A53
- Acetylalanine and derivs 1 A54
azidoacetyl-*dl*-alanine 1 A54
- Acetylbenzoylperoxide and derivs 1 A54–A55
acetylbenzoylperoxide 1 A54–A55
acetylbenzylperoxide 1 A55
acetylbromide 1 A55
acetyl-(3-nitrobenzoyl)-peroxide 1 A55
- Acetyl cellulose and derivs 1 A55–A56
acetyl cellulose or AC 1 A55–A56
nitroacetylcellulose or NAC 1 A56
- Acetyl chloride and derivs 1 A56–A56
azidoacetyl chloride 1 A57
nitroacetyl chloride 1 A57
- Acetyldiacetyltetrazanonane and derivs 1 A57
2-(4)-acetyl-1,9-diacetoxy-4(2)-6,8-trinitro-2,4,6,8-tetrazanonane or H-16 1 A57
- Acetyldiphenylamine and derivs 1 A57–A58
azidoacetyldiphenylamine 1 A58
dinitroacetyldiphenylamine 1 A58
hexanitroacetyldiphenylamine 1 A58
mononitroacetyldiphenylamine 1 A58
tetranitroacetyldiphenylamine 1 A58
- Acetylene and derivs 1 A59–A64
acetylene-air mixts 1 A61
acetylene and derivs, analysis 1 A63–A64
acetylene as an expl 1 A61–A62
acetylene condensation and polymerization product 1 A62–A63
acetylene derivs 1 A63–A64
- Acetylenedicarboxylic acid and derivs 1 A64–A65
acetylenedicarboxamide 1 A65
- Acetylenediurein or glycoluril 1 A65–A66
dinitroacetylenediurein 1 A65–A66
- Acetylene hydroperoxides and peroxides 1 A66–A67
- Acetylene manufacture of tetranitromethane 1 A67
- Acetylene-nitric acid reaction studies 1 A67
- Acetylene-oxygen and air mixts 1 A67–A68
- Acetylene ozonide 1 A68
- Acetylene reactions 1 A68
- Acetylenic compds 1 A68–A69
- Acetylenic polymers for solid proplnts 1 A69
- Acetylglycine, azide 1 A69
- N-Acetylhydrazobenzene 1 A69
- Acetyl laurin 1 A83–A84
- Acetylides and carbides (ivory) 1 A69–A83
acetylides 1 A69–A70
Al acetylide 1 A70
Ba acetylide 1 A70
Be acetylide 1 A70–A71
Cd acetylide 1 A71
Ca acetylide 1 A71
Ce hydrogen acetylide 1 A72
Co (ous) acetylide 1 A72
Cu (ous) acetylide 1 A72–A74

Acetylides and carbides (cont'd)

Cu (ic) acetylide 1 A74
 Cu acetylides, analytical 1 A74–A76
 gold acetylide 1 A76
 iron acetylide 1 A76
 monolithium hydroacetylide 1 A77
 lead acetylide 1 A76–A77
 dilithium acetylide 1 A77
 Mg acetylide 1 A77
 Mn acetylide 1 A78
 mercurous acetylide 1 A78
 mercuric acetylide 1 A78
 Ni acetylide 1 A78
 KH acetylide 1 A79
 di K acetylide 1 A79
 mono Rb acetylide 1 A79
 di Rb acetylide 1 A79
 silver acetylides 1 A79–A82
 Na H acetylide 1 A82
 di Na acetylide 1 A82
 Sr acetylide 1 A82
 Zn acetylide 1 A83
 As carbide 1 A70
 Be carbide 1 A71
 B carbide 1 A71
 Ca carbide 1 A71
 Cs carbide 1 A72
 Cr carbide 1 A72
 iron carbide 1 A76
 Li carbide 1 A77
 Mn carbide 1 A78
 Ni carbide 1 A78
 Si carbide 1 A79
 Th dicarbide 1 A82
 Ti carbide 1 A82
 W carbide 1 A82
 V carbides 1 A83
 Va carbide 1 A83
 Zr carbide 1 A83
 N-Acetyl-4-methyl-3-diazoniumhydroxide-amiline
 1 A22
 Acetylmethylnitrolic acid 1 A84
 Acetylmethoxydiazoles 1 A84
 Acetylmethoxydiazoles 1 A84
 4-acetyl-5-methyl-1,2,3-oxydiazole 1 A84
 4-acetyl-3-methyl-1,2,5-oxydiazole 1 A84
 3-acetyl-5-methyl-1,2,4-oxydiazole 1 A84
 Acetyl nitrate 1 A84–A85

Acetyl nitrite 1 A85
 Acetylperchlorate 1 A85
 9-Acetylphenanthrene 1 A85–A89
 Acetylphenylhydrazine and derivs 1 A85
 N'-acetyl-N-(2,4,6-trinitro-phenyl)-hydrazine
 1 A86
 dinitroacetylphenylhydrazine 1 A86
 mononitroacetylphenylhydrazine 1 A86
 Acetylphenylhydroxylamine and derivs 1 A86
 o-acetyl-N-(2,4,6-trinitrophenyl)-hydroxyl-
 amine 1 A86
 Acetylpyrrole and derivs 1 A86–A87
 3,4-(or 4,5-) dinitro-2-acetylpyrrole 1 A87
 mononitroacetylpyrrole 1 A86
 Acetylsalicylic acid and derivs 1 A87
 o-acetylsalicylic acid 1 A87
 mononitroacetylsalicylic acid 1 A87
 Achema-jahrbuch 1956/1958 1 A87
 Acid and base 1 A87–A88
 Acid boiling of NC 1 A88
 Acid egg or blowcase 1 A88
 Acid elevator 1 A88
 Acidity in acids 1 A88–A90
 Acidity of aromatic nitrocompsds 1 A90
 Acidity in expls 1 A90–A91
 Acidity in expls test 1 A91
 Acidity of mixed nitric-sulfuric acids 1 A91
 Acidity of nitrating bath 1 A91
 Acidity of weak acids 1 A91
 Acid magenta 1 A91–A92
 Acid number 1 A92
 Acidopentamminecobalt 1 A92
 Acid pumps 1 A92
 Acid-resistant materials 1 A92–A93
 Acids used in manufacture and analysis of expls
 1 A93
 Acme or Liardet powder 1 A93
 Aconitric acid 1 A93

- Acoustics 1 A93–A94
- Acoustic guidance systs for missiles 1 A94
- Acrawax 1 A94
- Acridine and derivs 1 A94–A95
 acridine dichromate 1 A95
 acridine nitrate 1 A95
 acridine perchlorate 1 A95
 acridine picrate 1 A95
 acridine-1,3,5-trinitrobenzene salt 1 A95
 dinitroacridine 1 A94
 mononitroacridine 1 A94
- Acridone and derivs 1 A95–A96
 dinitroacridone 1 A95
 mononitroacridone 1 A95
 2,4,5,7-tetranitro-9(10H)-acridone 1 A96
- Acrolein 1 A96
- Acrylamide and derivs 1 A96
 3-nitroacrylamide 1 A96
- Acrylic acid and derivs 1 A96–A97
 acrylic acid-trinitrophenylester 1 A97
 acrylic esters, monomeric 1 A97
 acrylic resins and plastics 1 A97
 acryloylazide 1 A97
 3-nitroacrylic acid 1 A97
- Acrylonitrile and derivs 1 A97–A98
 3-nitroacrylonitrile 1 A98
- ACT 1 A98
- ACT 5 1 A98
- ACT 5, erosion of 1 A98
- Action of gas explns on solid proplnts 1 A98
- Action time of a proplnt in a rocket 1 A98–A99
- Activation (or radioactivation) analysis 1 A99–
 A100; see Radiation gauging in energetic matls
 9 R76–R103, also Radioactive tracers 9
 R104–R113
- Activation energies of elementary reactions 1 A99
- Activation energies of expls 1 A100
- Action of light on expls, etc 1 VII; see Light,
 effect on expls 7 L14
- Activated complex theory 1 A4–A5
- Activation energies of fuels in high temp combstn
 1 A101
- Active list of permissible expls and blasting derivs
 1 A101 see also Permissible expls 8 P182–P183
- Active oxygen 1 A101
- Active sheath 1 A101
- Acyclic mercaptans containing 1-5 carbon atoms
 1 A101
- Acrylation 1 A101
- Acyl nitrates and perchlorates 1 A101
- Acyl peroxides 1 A101 see also Peroxides, organics
 1 P198–P212
- Acyl peroxides reactions with phenol 1 A102
- Adams 1 A102
- Adamsite see Diphenylaminochloroarsine 5 D1441
- Adapter 1 A102
- Adapter-booster 1 A102
- ADB see Aircraft-depth bombs 4 B950
- Adde expls 1 A102
- ADE 1 A102
- Adhesion 1 A102
- Adhesives 1 A102–A103
- Adhesive tape for packaging and packing of ammo
 1 A103
- Adiabatic compression of entrapped gas or vapor
 as a cause of initiation of expls 1 A103
- Adiabatic expln 1 A103
- Adiabatic flame temp 1 A103–A104
- Adiabatic ignition of proplnts, pyrot compns, etc
 1 A104
- Adiabatic ignition test of proplnts 1 A104
- Adinau expl 1 A104
- Adipic acid and derivs 1 A104–A105
 adipic acid, analytical procedure 1 A104
 adipic acid diazide 1 A104
- Adipocellulose and cutocelluloses 1 A104–A105
- Adobe shooting 1 A105 see Mudcapping under
 Agriculture and forestry uses of expls 1 A113;
 Mudcapping 8 M160
- Adsorption and adsorbents 1 A105

- Adsorption analysis 1 A105
- ADT and ADV proplnts 1 A105
- Advance deton 1 A106–A106 see also Detonation, initiation, and propagation in expl substances 4 D402–D482
- “Advanced” missiles see also Ballistic missile 2 B6; Missile (guided, nonballistic) 8 M144–M145
- AEHP see Anhydroenneaheptitol 1 A404
- Aeration of expls 4 D138
- Aerial bomb, aerial torpedo 1 A106 see Bombs 2 B225–B241
- Aerochemical device 1 A106
- “Aero” cyanamid 1 A106
- Aerodynamics and its application in ballistics 1 A106–A107 see also Ballistics 2 B7–B10
- Aerodynamics of propulsion 1 A107
- Aerodynamics, supersonic (high speed) 1 A107
- Aeroelasticity 1 A107
- Aerogels 1 A107–A108
- Aerojet Engrg Corp, Azusa, CA 1 A108
- Aerojet proplnts and other substances 1 A108
- Aerolit 1 A108
- Aeronautics 1 A108
- Aeroplex proplnts 1 A108
- Aerosols 1 A108–A109
- Aetna Expls Company 1 A109
- AEV proplnt 1 A109
- Afosite 1 A109
- Afror tyne powder 1 A109
- After-flame ratio 1 A109
- After-separation 1 A109 see Glycerol trinitrate 6 G99–G104
- AFU proplnt 1 A109
- Agar-agar 1 A110
- Agave 1 A110
- AGB 1 A110
- Aged proplnts, solubilities 1 A110
- Aging of Dynamites 1 A110–A112 see Dynamite 4 D1584–D1723
- Aging mine expls contg ammonium nitrate and chlorides 1 A112
- Agesid 2 1 A112
- Agfa 1 A112
- Aging of proplnts 1 A112
- Aging of proplnts in storage 1 A112 see Degradation of proplnts in storage 3 D41
- AGJ and AGK proplnts 1 A112
- Agriculture and forestry uses of expls 1 A112–A114
forestry uses of expls 1 A114
mudcapping 1 A113
- AHH proplnt 1 A114
- Aimable cluster 1 A114 see Bombs for aircraft 2 B226–B227
- Air analysis and air sampling 1 A114–A116
- Air blast 1 A116
- Air-blast pressure from small charges of various expls 1 A116
- Air-blast pressure from some large bombs 1 A116
- Air-burst effects of the blast from bombs and small charges 1 A116
- Air conditioning 1 A116
- Airdox 1 A117
- “Aircraft and Missile Propulsion” 1 A117 see Rocket 9 R176–R177
- Air gap sensitiveness to detonation 4 D138
- Air-gap test 4 D397–D398
- Air lifts 1 A117–A118
- Airplane take-off apparatus 1 A117
- Air pollution 1 A117 see Pollution abatement in the US military expls and proplnts manufg industry 8 P317–P324
- Air Reduction Sales Co 1 A117
- Air resistance to projectiles in flight 1 A117 see Ballistics 2 B7–B8

- Air, thermodynamic properties 1 A118
- Air-tightness test 1 A118
- Air warfare and aircraft armament 1 A118
- Aix-la-Chapelle (poudre d') 1 A118–A119
- Ajax powder 1 A119
- AJZ proplnt 1 A119
- AK-14 and AK-14 (mod 1) rocket fuel oxidizers 1 A119
- A (ko) or type A expl 1 A119
- Akremite 1 A119
- Aktiebolaget see Bofors Industries 2 B218–B219
- AL-31 rocket expl 1 A119
- Alba Chem Co of NY 1 A119
- Albanite 1 A119–A120
- Albionite 1 A120
- Albit 1 A120
- Albite 1 A120
- Alcohol 1 A120
- Alcohols, heats of combstn and formation 1 A120
- Alcohols, nitrated, heats of combstn and formation 1 A120
- Alcohols, nitrated, prepn 1 A120
- Aldehyde 1 A120
- Aldehyde-amine conensation products 1 A120–A121
- Aldehyde-nitroparaffin reactions 1 A121
- Aldehydes, oxidation and ozonization 1 A121
- Aldehydes, polarographic method of determination 1 A121
- Aldehydes, role in oxidation of hexane 1 A121
- Aldol and aldol condensation reactions 1 A121
- 5-Aldolimino-(α -tetrazole) 1 A121–A122
- Aldolnaphthylamine condensation product 1 A122
- Aldonic acids, their derivs and nitric esters 1 A122
A123
d-galactonamide pentanitate 1 A123
- Aldonic acids (cont'd)
d-gluconamide pentanitate 1 A123
methyl-di-galactonate pentanitate 1 A123
methyl-d-gluconate pentanitate 1 A123
- Aldorfit 1 A123
- Aleurityl azide 1 A123–A124
- Alexander's expl compns 1 A124
- Alexander's primary expl 1 A124
- Alginic acid 1 A124
- Algodon fulminate 1 A124
- Aliphatic alkanolamine per chlorate salts 1 A124
- Aliphatic amines and imines, nitrated derivs 1 A124
- Aliphatic peracids 1 A124 see Peroxides, organic, Table 6 8 P201, Peroxy acids P212–P214
- Aliphatic peracids, analysis 1 A124–A125
- Alkali and alkaline earth metals 1 A125
- Alkalies, action on aliphatic nitro compds 1 A125
- Alkalies, action on aromatic nitro compds 1 A125–A126
- Alkalies, action on nitric esters 1 A126–A127
- Alkali metal amides 1 A127
- Alkali metals and halides of metals 1 A127
- Alkalinity in expls and proplnts 1 A127
- Alkalinity test 1 A127
- Alkalsit 1 A127
- Alkanes, nitrated derivs 1 A127
- Alkalites 1 A127–A128
- Alkenyl aromatics 1 A128
- Alkyd resins 1 A128
- α -Alkylacrylonitriles 1 A128–A129
 α -ethylacrolein oxime 1 A129
 α -isopropylacrolein oxime 1 A129
- Alkylamides and their nitrated derivs 1 A129
- Alkyl and aryl azides 1 A129
- Alkylated benzenes, nitro derivs of 1 A129
- Alkylated benzidines, nitrated derivs 1 A129

- Alkylation 1 A130
- Alkylation, regeneration of acid used in 1 A130
- Alkyl azides 1 A130
- Alkyl hydrazines 1 A130
- Alkylideneperoxide 1 A130–A131 see Peroxides, organic 8 P199–P205, P210–P212
- Alkylized diamines of the aromatic series, nitro-compds of 1 A131
- Alkylmercaptosilanes 1 A131
- Alkylnitramines 1 A131
- Alkylnitramines, nitroxy 1 A131
- Alkyl nitrates as liq monofuels 1 A131
- N-Alkyl-N'-(2-nitroxyethyl) ethylene dinitramines 1 A131–A132
- Alkylolamines, nitrated products 1 A132
- Alkyl peroxides, decompn 1 A32 see Peroxides organic 1 P199
- Alkyl silanes 1 A32 see Silanes and derivs 9 S85–S86
- N-Alkyl-N'-(5-tetrazolyl) - ureas 1 A132–A133
- Alkyltetrazylazides 1 A133
- Alkyl-tris-hydroxymethyl-methane triacetates 1 A133
- Alkyltrimethylolmethane trinitrates 1 A133
- Alkynes 1 A133
- Allan R. Lambourn (detonation) equation of state 4 D271
- ALL (proplnt) 1 A133
- Allégé explosifs 1 A133
- Allenic compds 1 A133
- Allison powder 1 A133
- Allophanylazide 1 A133–A134
- Allophanylhidrazide 1 A134
- Alloxan 1 A134
- Alloys suitable for use in ordnance plants 1 A135
- Alloys, analysis 1 A135
- Allumage (Fr) 1 A135
- Allumeur (Fr) 1 A135
- Allumeur de sureté (Fr) 1 A135
- Allylacetone and derivs 1 A135–A136
allylacetone ozonide 1 A135
allylalcohol 1 A135–A136
allylamine-diphenylcarbonide complex 1 A136
5-(allylamino)-1-amino- α -tetrazole 1 A136
- 1-Allyl-5-amino- α -tetrazole 1 A136
2-allyl-5-amino- β -tetrazole 1 A136
- Allylaniline and derivs 1 A136–A138
allylazide 1 A137
allylbenzeneozonide 1 A137
N-allyl-N',N'-diphenylurea 1 A137
allylethers of carbohydrates 1 A137
N-allyl-o-nitroaniline 1 A136–A137
N-allyl-2,4-dinitroaniline 1 A137
N-allyl-2,4,6-trinitroaniline 1 A137
- Allylene 1 A140
- Allylguanidine and derivs 1 A138
allylnitrite 1 A138
N-allyl-N'-nitroguanidine 1 A138
allyl, nitro 1 A138
allylnitrolic acid 1 A138
2-allyloxyemthyl-2-hydroxymethyl-1,3-propanediol trinitrate 1 A138
- Allylpentaerythritol and derivs 1 A138–A139
allylpentaerythritol trinitrate 1 A139
allylpentaerythritol trinitrate polymer 1 A139
allylpicrate 1 A139
- Allyltriazone and derivs 1 A139–A140
1-allyl-dinitrotriazone 1 A140
- Almatrites (Rus) 1 A140
- Almidón tetranitrico (Sp) 1 A140
- Aloe, nitrated 1 A140
- Aloeemodine 1 A140
tetranitroaloeemodine 1 A140
- Alox 600 1 A141
- Aloxite 1 A141
- Alperox C 1 A141
- Alpha-cellulose 1 A141
- Alpha particles as initiators of deton 1 A131
see also Radiation effects on expls, proplnts and pyrots 9 R5–R6 (α particle irradiation)

- Alphonse 1 A141
- Alsilite 1 A141
- ALT 1 A141
- Alumatol 1 A141–A142
- Aluminum 1 A142–A146
 aluminum alkyl halides 1 A144–A145
 aluminum alkyl hydrides 1 A145
 aluminum (analytical procedures) 1 A143
 aluminum block expansion test 1 A145
 aluminum block (of Kreulen) 1 A145
 aluminum containing alloys 1 A145–A146
- Aluminum chlorate 2 C184
- Aluminum chloride 3 C236
- Aluminum chloride-Nitrobenzene complex 3 C236
- Aluminum contg expls 1 A146–A151
 aluminum contg expls, Trauzl test values
 1 A151
- Aluminum cordeau 1 A151
- Aluminum dust and its explns 1 A151–A152
- Aluminum dust in rocket proplnts 1 A152
- Aluminum flares 1 A152–A153
- Aluminum hydride 1 A153
- Aluminum, illuminating powders 1 A153–A154
- Aluminum-liquid oxygen and liquid air explns
 1 A154
- Aluminum-lithium hydride 1 A154–A155
- Aluminum-methanol expls 1 A155
- Aluminum ophorite 1 A155
- Aluminum oxide-silicon carbide fiber 1 A155
- Aluminum plate test for detonators 1 A155
- Aluminum soap gels 1 A155
- Aluminum soaps of mixed isotoic acids 1 A155
- Aluminum triazide 1 A521
- Alums 1 A156–A157
 ammonium-aluminum alum 1 A156
 ammonium chrome alum 1 A156
 ammonium-iron alum 1 A156
 potassium-aluminum alum 1 A156
 potassium-chrome alum 1 A156
- Alums (cont'd)
 potassium-iron alum 1 A156–A157
 sodium-aluminum alum 1 A157
- Alundum 1 A157
- Alvisi 1 A157
- Am (Fr) 1 A157
- Amalgam 1 A157
- Amasite 1 A157
- Amatex 1 A157
- Amatol 1 A158–A165
 analytical procedures 1 A164–A165
- Amatoxol 1 A165
- Amber 1 A165
- Amberites 1 A166
- Amberlac 1 A166
- Amberlite 1 A166
- Amberol 1 A166
- Ame (Fr) 1 A166
- Ame de canon (Fr) 1 A166
- American bomb high expl trains 2 B223–B224
- American Chemical Society 1 A166
- American Dynamite 1 A167
- American Dynamites, gelatinized 1 A167 see also
 American Dynamites and substitutes 5 D1724
- American Dynamites, low freezing, nongelatinized
 1 A167 see also American Dynamites and
 substitutes 5 D1724
- American Dynamites, ordinary 1 A167 see also
 American Dynamites and substitutes 5 D1724
- American Dynamites, ordinary, with ammonium
 nitrate 1 A167 see also American Dynamites
 and substitutes 5 D1724
- American Electroplastics Corp expl 1 A167–A168
- American expl 1 A168
- American Forcite Powder Co 1 A168
- Americanite 1 A168
- American mixt see Berger mixts 2 B102

- American permissible expls see permissible expls
8 P182–P183
- American powder 1 A507
- American smokeless proplnts 1 A168
- American stability tests at 65.5° and 80° see
Stability and instability of expls 6 E438
- American table of distances for storage of expls
1 A168 see also Safety in the energetic field
9 S11–S14
- Amidation 1 A168
- Amide 1 A168
- Amide powder 1 A168
- Amides, imides, and derivs 1 A168–A171
amides and imides, inorganic 1 A168–A170
amides and imides, organic 1 A170
amides and imides, organic analytical proce-
dures 1 A170–A171
amides and imides, organic, nitrated 1 A171
- Amidines or Aminoimines 1 A171
- Amidogène 1 A171
- Amidon (poudre à l') 1 A171
- Amidon nitré 1 A171
- Aminated cellulose or aminocellulose 1 A172
- Aminated cellulose acetate esters 1 A172
- Amination 1 A172
- Amines 1 A172–A178
amines and imines, analytical procedures
1 A174
amine, catalyzed nitration 1 A174
amines, complexes 1 A174
amines, condensation with aromatic chlorine
comps 1 A174
amines nitrated and nitrited 1 A174–A177
amines nitrated and nitrited, analytical proce-
dures 1 A177
amine peroxides as expls 1 A177–A178
amine picrates 1 A178
aminoacetic acid 1 A178
aminoacetic acid nitrate 1 A178
nitraminoacetic acid 1 A178
- Aminoacetophenones and derivs 1 A178–A179
aminoacetophenones, azido derivs 1 A178
mononitraminoacetophenones 1 A178–A179
- Aminoacridines 1 A179
- Aminoalcohols 1 A179
- Aminoalcohols, aliphatic, nitrated derivs 1 A180
- Amino alcohols, nitrated and nitrited 1 A179
- Aminoalkylguanidines 1 A180
- Aminoalkylguanidines nitrated derivs 1 A180
- Aminoalkyltetrazoles 1 A180–A181
- Aminoalkyltriazoles 1 A181
- 1-Amino-5-alkylamino- α -tetrazole 1 A181
- Aminoanisoles and derivs 1 A182–A183
aminoanisole, analytical procedures 1 A183
dinitroaminoanisoles 1 A182
mononitroaminoanisoles 1 A182
trinitroaminoanisoles 1 A182
- Aminoanthraquinones and derivs 1 A183–A184
dinitroaminoanthraquinones 1 A183
dinitronitraminoanthraquinones 1 A183–A184
mononitroaminoanthraquinones 1 A183
nitraminoanthraquinones 1 A183
nitronitraminoanthraquinones 1 A183
- Aminoazaurolic acid 1 A184
- Aminoazobenzenes and derivs 1 A184–A185
dinitroaminoazobenzenes 1 A185
mononitroaminoazobenzenes 1 A185
- Aminoazobenzenetriazole and derivs 1 A185
- Aminoazoxybenzenes 1 A185–A186
3'-nitro-3-aminoazoxybenzene 1 A186
- Aminobenzaldehydes and derivs 1 A186
dinitroaminobenzaldehydes 1 A186
mononitroaminobenzaldehydes 1 A186
nitraminobenzaldehyde 1 A186
- Aminobenzamides and derivs 1 A186–A187
dinitro-4-aminobenzamide 1 A186–A187
- 1-Aminobenzene-4-diazonium hydroxide 1 A187
- Aminobenzenyloxytetrazotic acid methyl ester
1 A187
- Aminobenzimidazoles and derivs 1 A187–A188
4 (or) 7-amino-6 (or) 5-nitrobenzimidazole
1 A188
- Aminobenzoic acids and derivs 1 A188–A189
aminobenzoic acid, acid derivs 1 A188–A189

- Aminobenzoic acids and derivs (cont'd)
 aminobenzophenones 1 A189
 dinitroaminobenzoic acids 1 A189
 dinitronitraminobenzoic acids 1 A189
 mononitroaminobenzoic acids 1 A189
- Aminobenzotriazines and derivs 1 A189–A190
- Aminobenzotriazoles and derivs 1 A190
- 5-Amino-1-benzyl-vic-tetrazole 1 A191
- Aminobiphenyls and derivs 1 A191
 dinitroaminobiphenyls 1 A191
 mononitroaminobiphenyls 1 A191
 trinitroaminobiphenyls 1 A191
- Amino-boranes 1 A192
- Aminoboronhydride compds 1 A192
- 2-Amino-1-butanol and deriv 1 A192–A103
 2-nitramino-1-butanol nitrate 1 A192–A193
- Aminocarbazoles and derivs 1 A193
 mononitroaminocarbazoles 1 A193
- Aminocarbonylamino succinyl diazide 1 A193
- 1-Amino-5-(o-chlorophenyl)- α -tetrazole 1 A193
- Aminocresols and derivs 1 A193–A194
 dinitroaminocresols 1 A194
 dinitronitraminocresols 1 A194
 mononitroaminocresols 1 A194
- Aminodiazacycloalkanes nitrated derivs 1
 A194–A195
- 4-Amino-diazoaminobenzene 1 A195
- 2-Amino-7-diazonaphthalene bromide hydro-
 bromide 1 A195
- 6-Amino-2,2'-dicarboxybiphenyl-6'-diazonium
 chloride 1 A195
- 2-Amino-4,4-dimethyl-1-nitro- Δ^2 -imidazole
 nitrate 1 A195
- Aminodimethyltriazoles and derivs 1 A196
- Aminodiphenylamines and derivs 1 A196–A198
 dinitroaminodiphenylamines 1 A197
 mononitroaminodiphenylamines 1 A196–A197
 tetranitroaminodiphenylamines 1 A198
 trinitrodiphenylamines 1 A197
- Aminodiphenyleneoxides and derivs 1 A198
 mononitroaminodiphenyleneoxides 1 A198
 x-tetranitro-3-aminodiphenyleneoxide 1 A198
- Aminodiphenylethers and derivs 1 A198–A199
 dinitroaminodiphenylethers 1 A199
 mononitroaminodiphenylethers 1 A198–A199
 3,5,2',4'-tetranitro-4-aminodiphenylether
 1 A199
 3,2',4'-trinitro-4-aminodiphenylether 1 A199
- Aminoethane and derivs 1 A199–A200
 aminoethanediperoxide 1 A200
 β -azidoaminoethane 1 A199
 nitraminoethane 1 A199
- Aminoethanol (ethanolamine) and derivs 1 A200–A201
 aminoethanol, alkyl derivs of 1 A201
 aminoethanol-bis[copper (II) diazide] 1 A200
 aminoethanol derivs, proposed by E. von Herz
 1 A210
 2-amino-2,2-dinitroethanol 1 A210
 aminoethanol (ethanolamine) dinitrate 1 A200
 1-nitramino-2-ethanol 1 A200
 1-nitroamino-2-ethanol nitrate or NENA 1 A210
- Aminoethoxyphenyltetrazoles 1 A201
 5-nitrosamino-1-p-ethoxyphenyl- α -vic-tetrazole
 1 A201
- Aminoethylation 1 A201–A203
- Aminoethylation of cellulose derivs and of regener-
 ated cellulose 1 A203
- Aminoethylation of N-(2-hydroxypropyl)-ethylene-
 diamine 1 A203
- Aminoethylation of toluene diisocyanate 1 A203
- Aminoethylcellulose (AEC) 1 A203–A204
- Aminoethylcellulose nitrate (AEC) 1 A204
- Aminoethylcellulose (AEC) 1 A204
- Aminoethylguanidine and derivs 1 A205
 1- β -nitroaminoethyl-1-nitroso-2-nitroguanidine
 1 A205
- Aminoethylnylon (AEN) and its perchlorate (AENP)
 1 A205
- Aminoethylpolyurethane (EAPU) 1 A205
- Aminoethylpolyvinyl alcohol (AEPVA) and its
 perchlorate (AEPVAP)
- Aminoethylpolyvinyl chloride (AEPVC) 1 A205–A206
- Aminoethylprotein 1 A206
- Aminoethylpropylureas and derivs 1 A206
 N-(β -nitraminoethyl)-N'-propyl-urea 1 A206

- Aminoethylpropylureas and derivs (cont'd)
 N-(β -nitraminoethyl)-N-propyl-N'-nitro-urea
 1 A206
- Aminoethylstarch (AES) and its perchlorate 1
 A206
- Aminoethyltetrazoles and derivs 1 A206–A207
 5-amino-1-ethyl- α -tetrazole 1 A206–A207
 5- β -aminoethyl-1H-tetrazole 1 A207
 5-ethylamino- α -tetrazole 1 A207
- Aminoethyltriazoles and derivs 1 A207–A209
 3-amino-5-ethyl- α -sym-triazole 1 A207
 1-(β -aminoethyl)- α -sym-triazole 1 A208
 3-(β -aminoethyl)- α -sym-triazole 1 A208
 4-(β -aminoethyl)- α -vic-triazole 1 A208
 3-(β -diethylaminoethyl)- α -sym-triazole di-
 picrate 1 A209
 3-(β -ethylaminoethyl)- α -sym-triazole 1
 A208–A209
 3-ethyl-1,2,4-triazole-5-diazoniumhydroxide
 1 A208
- Aminoethylureas and derivs 1 A209
 3-(2-aminoethyl)-1-nitrourea 1 A209
 3-(2-nitraminoethyl)-1-nitrourea 1 A209
- Aminoguanazole and derivs 1 A209–A210
- Aminoguanidine and derivs 1 A210–A214
 aminoguanidine and derivs, analytical pro-
 cedures 1 A214
 aminoguanidine diazonium hydroxide 1 A210
 aminoguanidine nitrate 1 A210
 aminoguanidine picrate (AGuP) 1 A210
 nitraminoguanidine (NAGu) 1 A210–A212
 nitroaminoguanidine (NAGu) salts 1
 A212–A213
 nitronitrosaminoguanidine 1 A213–A214
- Aminoguanylbiguanidine and derivs 1 A214–A215
 2-(aminoguanyl)-1,6-dinitro-biguanidine-
 benzolhydrazone 1 A215
 benzolhydrazone 1 A215
 benzalaminoguanidinium-1,6-dinitro-2-(amino-
 guanyl)-biguanidine benzal hydrazone
 1 A215
 bis-(aminoguanidinium)-1,6-dinitro-2-(amino-
 guanyl)-biguanidine 1 A214–A215
 bis-(aminoguanidinium)-1,6-dinitrobiquanidine
 1 A214
 bis-(benzalaminoguanidinium)-1,6-dinitro-
 biguanidine 1 A215
 1,6-dinitro-2-(aminoguanyl)-biguanidine 1 A214
- Aminoguanylbiguanidine and derivs (cont'd)
 1,6-dinitro-2-(aminoguanyl)-biguanidine,
 ammonium salt 1 A214
 1,6-dinitro-2-(aminoguanyl)-biguanidine nitrate
 1 A214
- Aminohemimellitene 1 A215
- Aminoheptanes 1 A215
- Aminohexanes 1 A215–A216
- 4-Amino-5-hydrazino-3-mercapto-4H-s-triazole
 1 A216
- 1-Amino-5-hydrazino-vic-(1,2,3,4)-tetrazole 1 A216
- 3-Amino-5-hydrazino-1,2,4-triazole dihydro-
 chloride 1 A216–A217
- Aminohydroxyanthraquinones and derivs 1 A217
 nitronitraminohydroxyanthraquinones 1 A217
 2,4,5,7-tetranitro-8-amino-1-hydroxy-anthra-
 quinone 1 A217
- Aminohydroxyazobenzenes 1 A217
- Aminohydroxybenzoic acids and derivs 1 A217–A218
 2-6-dinitro-4-amino-3-hydroxybenzonitrite 1 A218
 nitroaminohydroxybenzoic acids 1 A217–A218
- 2'-Amino-1-hydroxy-1H-benzotriazole 1 A177
- 1-Amino-5-hydroxy-1,2,3-triazole-4-carboxylic
 acid hydrazide 1 A218
- Aminoimidazoles and derivs 1 A218–A219
 4(5)-aminoimidazole 1 A218
 4(5)-amino-5(4)-imidazolecarboxamide 1 A218
 4(5)-aminoimidazole dipicrate 1 A218
- Aminoimidazolidines and derivs 1 A219
 1-nitro-2-amino-2-nitraminoimidazolidine
 1 A219
- Aminoimidazolines and derivs 1 A219–A220
 2-amino-1-nitro- Δ^2 -imidazoline 1 A219–A220
 2-nitramino- Δ^2 -imidazoline 1 A219
 2-nitro-2-nitramino- Δ^2 -imidazoline 1 A220
 1-nitroso-2-nitramino- Δ^2 -imidazoline 1 A220
- Aminoimidazoline and imidazolidine substituted
 derivs 1 A220–A221
- Aminoimidazolinol and derivs 1 A222
 2-nitramino-2-imidazolinol 1 A222
- Aminoimidazolin-1-yl and derivs 1 A222–A223
 1-[2-(2-nitramino- Δ^2 -imidazolin-1-yl) ethyl]-
 3-nitro-guanidine 1 A222

Aminoimidazolin-1-yl and derivs (cont'd)

- 3-nitro-guanidine 1 A222
- 1-[2-(2-nitramino- Δ^2 -imidazolin-1-yl) ethyl]-3'-nitro-1'-nitroso-guanidine 1 A222
- 1'-[β (2-nitrimino-3-nitro- Δ^2 -imidazolin-1-yl-ethyl)-1',3' dinitro guanidine 1 A222

Aminoindazoles and derivs 1 A224

- 5-amino-2-mercapto-1,3,4-triazole 1 A224
- 5,7-dinitro-6-aminoindazole 1 A224

2-Amino-4 (or 5)- Δ^2 -imidazolone 1 A222–A223

4-Amino-7H-imidazo [4,5-d] -triazine 1 A223

Aminoimidoethane and derivs 1 A223

4-Amino-3-imino-2,5-dihydro- α -sym-triazole 1 A2234-Amino-5-imino-3 methyl-dihydro- α -sym-triazole 1 A223–A224

Aminomesitylenes and derivs 1 A224–A225

- 2-amino-4,6-diazidomesitylene 1 A224–A225
- 1-aminomesitylene 1 A225
- aminomesitylenebisdiazonium chloroaurate hydrochloride 1 A225
- 4,6-dinitro-2-aminomesitylene 1 A225
- 4-nitro-2-aminomesitylene 1 A225
- 6-nitro-4-azido-2-aminomesitylene 1 A225

Aminomethane and derivs 1 A225–A227

- aminoethane chlorite 1 A226
- aminoethane nitrate 1 A226–A227
- aminomethane nitroform 1 A227
- aminomethane perchlorate 1 A227
- nitraminomethane 1 A227

Aminomethoxyphenyltetrazoles and derivs 1 A228

- 5-(3'-amino-p-anisyl)-tetrazole 1 A228
- 5-amino-1-(o-methoxyphenyl)- α (or 1H)-tetrazole 1 A228
- 5-amino-1-(m-methoxyphenyl)- α (or 1H)-tetrazole 1 A228
- 5-amino-1-(p-methoxyphenyl)- α (or 1H)-tetrazole 1 A228
- aminomethoxyphenyltetrazoles, identification by means of IR spectroscopy 1 A228
- aminomethoxyphenyl-tetrazoles, thermal isomerization 1 A228
- 5-(4-anisyl)-5-aminotetrazole 1 A228

Aminomethylaminoimidazolidines and derivs 1 A228

- 2-amino-2(methyl-nitramino-1-nitroimidazolidine 1 A228

Aminomethylbiphenyls and derivs 1 A229

- dinitroaminomethylbiphenyls 1 A229
- 3,5-dinitro-4-methyl-nitroso-biphenyl 1 A229
- mononitroaminomethylbiphenyls 1 A229
- pentanitrophenylbenzylamine 1 A229
- tetranitroaminomethylbiphenyls 1 A229
- trinitroaminomethylbiphenyls 1 A229
- N-(2,4,6-trinitrobenzyl)-3'-nitroaniline 1 A229

Aminomethyldiphenylamines and derivs 1 A229–A231

- dinitroaminomethyldiphenylamines 1 A230
- mononitroaminomethyldiphenylamines 1 A230
- 2,4,6,2',4'-pentanitro-3-methylnitramino-diphenylamine 1 A231
- tetranitronitraminomethyldiphenylamines 1 A230
- trinitroaminomethyldiphenylamines 1 A230
- 2,4,6-trinitro-3-methylnitraminodiphenylamine 1 A230

Aminomethylguanidines and derivs 1 A231–A232

- methylaminoguanidine 1 A232

Aminomethylnitrosolic acid 1 A232

Aminomethylpropanediols and derivs 1 A232

- 2-amino-2-methyl-2,3-propanediol dinitrate 1 A232

Aminomethylpropanols and derivs 1 A233

- 2-nitramino-2-methyl-1-propanol nitrate 1 A233

Aminomethyl- and methylamino-tetrazoles and derivs 1 A233–A234

- 5-methylamino- α -tetrazole 1 A234
- 5-nitrosamino-1-methyl- α -tetrazole 1 A234

Aminomethylthiazoles and derivs 1 A234–A235

- 2-amino-4-methyl-5-nitrothiazole 1 A235
- 3,5-dinitro-4-methyl-2-nitrimino-4-thiazoline 1 A235
- 2-(N-methylamino)-5-nitrothiazole 1 A235
- 2-(N-methylnitramino)-thiazoles 1 A235
- 2-nitramino-4-methyl-5-nitrothiazole 1 A235

Aminomethyltriazoles and derivs 1 A235–A237

- nitraminomethyltriazoles 1 A236–A237
- nitrosaminomethyl-triazoles 1 A236

Aminonaphthalenes and derivs 1 A237–A238

- dinitroaminonaphthalenes 1 A237
- nitroaminonaphthalenes 1 A237
- tetranitroaminonaphthalenes 1 A237–A238
- trinitroaminonaphthalenes 1 A237

- Aminonicotinic acids and derivs 1 A238–A239
 nitroaminonicotinic acids 1 A238
 3-nitramino-iso-nicotinic acid 1 A238–A239
 (2-Amino-2-nitramino-1-nitro)-imidazolidine
 5 D1138
- Aminonitroform 1 A239
- Aminooxazolines and derivs 1 A239
- Aminooxytriazoles and derivs 1 A240
- Aminophenetoles and derivs 1 A240–A241
 dinitroaminophenetoles 1 A240
 mononitroaminophenetoles 1 A240
 trinitroaminophenetoles 1 A240–A241
- Aminophenols and derivs 1 A241–A245
 aminophenols and derivs, analytical procedures
 1 A245
 dinitroaminophenols 1 A241–A244
 picramic acid and salts 1 A241–A243
 trinitroaminophenols 1 A244
- Aminophenylarsonic acid and derivs 1 A245
 3,5-dinitro-4-aminophenylarsonic acid 1 A245
 nitroaminophenylarsonic acid 1 A245
- Aminophenylethanol and derivs 1 A245–A246
 2-(2',6'-dinitro-4'-aminophenyl)-ethanol 1 A246
- Aminophenylperimidines and derivs 1 A246
- Aminophenylphosphonic acids and derivs 1 A246
 compd $C_6H_6N_3O_6P + 3H_2O$ 1 A246
 nitroaminophenylphosphonic acids 1 A246
- Aminophenyltetrazoles and derivs 1 A246–A249
 aminonitrophenyl- α -tetrazoles 1 A248–A249
 N'-amino-N'-phenyl-N³-(tetrazolyl-s)-triazine 1 A247–A248
 5-nitrosamino-1-phenyl- α -tetrazole 1 A248
- Aminophenyltriazoles 1 A249
- Aminopicolines and derivs 1 A249
 nitraminopicolines 1 A249
 nitroaminopicoline 1 A249
- Aminopicolinic acids and derivs 1 A249–A250
 3-nitraminopicolinic acid 1 A249–A250
- Aminopropanediols and derivs 1 A251–A252
 aminopropanediol derivs of den Otter 1
 A251–A252
- Aminopropanes and derivs 1 A250
 aminopropanol salts 1 A250
- Aminopropanes and derivs (cont'd)
 azidoaminopropanes 1 A250
 1,1-dinitro-2-aminopropane 1 A250
 nitroaminopropanes 1 A250
- Aminopropanoic acids and derivs 1 A252–A253
 3-nitraminopropanoic acid 1 A252–A253
- Aminopropanols and derivs 1 A253
 3-amino-2-nitroxypropane nitrate 1 A253
 nitraminopropanol nitrate or Iso-Me-NEHA
 1 A253
- Aminopropenes and derivs 1 A253–A254
- Aminopseudocumenes and derivs 1 A254
- Aminopurines and derivs 1 A254
- Aminopyridines and derivs 1 A254–A255
 dinitroaminopyridines 1 A255
 mononitroaminopyridines 1 A254
 nitronitraminopyridines 1 A254–A255
- Aminopyridylpyrazole and derivs 1 A255
- Aminoquinoline and derivs 1 A255–A256
 dinitroaminoquinolines 1 A256
 nitraminoquinolines 1 A256
 nitronitraminoquinolines 1 A256
- Amino resins and plastics 1 A256
- Aminoresorcinols and derivs 1 A256–A257
 4,6-dinitro-2-aminoresorcinol 1 A257
 mononitroaminoresorcinols 1 A256
 2,4,6-trinitro-5-aminoresorcinol 1 A257
- Aminosalicylic acid and derivs 1 A257
 nitroaminosalicylic acids 1 A257
- Aminostyrenes and derivs 1 A257
 2, ω (or 3, ω)-dinitro-4-aminostyrene 1 A257
- Aminotetrazole and derivs 1 A257–A262 see
 1-Amino-tetrazole and derivs 9 T115–T121
 [N',N⁶-bis(α -tetrazolyl-5)]-hexazadiene 1
 A260–A261
 5-nitraminotetrazole (5-NATZ) 1 A259–A260;
 9 T116–T117
- Aminothiadiazole and derivs 1 A262–A263
 5-azido-2-nitrosamino-1,3,4-thiadiazole 1 A262
 2-nitramino-1,3,4-thiadiazole 1 A263
 5-nitro-2-amino-1,3,4-thiadiazole 1 A262–A263
 2-nitrosamino-1,3,4-thiadiazole 1 A262
- Aminothiazoles and derivs 1 A263–A264
 2-amino-5-nitrothiazole 1 A263

Aminothiazoles and derivs (cont'd)

- 2-nitramino-5-nitrothiazole 1 A263
- 2-nitramino-3,4,5-trinitrothiazolone 1 A263–A264; 9 T218

Aminothiatriazole and derivs 1 A264

Aminotoluenes and derivs 1 A264–A265 see

The Toluidines 9 T319–T322

- dinitroaminotoluenes 1 A265; 9 T320–T322
- dinitronitraminotoluenes 1 A265
- mononitroaminotoluenes 1 A265
- nitraminotoluenes 1 A265
- nitronitraminotoluenes 1 A265
- 2,4,6-trinitro-3-aminotoluene 1 A265

Aminotolyltetrazoles and derivs 1 A265–A267

- 1,1'-azo-5,5'-di(p-tolyl)-tetrazole 1 A266–A267
- 1,1-(N-dichloramino)-5-(p-tolyl)- α (or 1H)-tetrazole 1 A266

Aminotriazines and derivs 1 A267; The vicinal or 1,2,3-triazines 9 T353

Aminotriazolecarboxylic acids and derivs 1 A270

- 5(4)-amino- α -victriazole-4(5)-carboxamide 1 A270
- 5-nitrosamino- α -sym-triazole-3-carboxylic acid 1 A270

Aminotriazoledione and derivs 1 A270–A271

Aminotriazoles and derivs 1 A267–A270

- 3-nitramino- α -sym-triazole 1 A269–A270

Aminotriazolopyrimidines and derivs 1 A271

Aminotriazolopyrimidinols and derivs 1 A271

Aminourazoles and derivs 1 A271–A272

Aminoxylenes and derivs 1 A272–A273

- dinitroaminoxylens 1 A272
- dinitronitraminoxylens 1 A272
- nitraminoxylens 1 A272
- 2,4,6-trinitro-5-amino-m-xylene 1 A272–A273

Ammelide and derivs 1 A273

- nitroammelide 1 A273

Ammeline and derivs 1 A273–A274

- dinitroammelide 1 A273–A274

Ammeline picrate 1 A274

Ammiachno-selitrennyl porokh 1 A274

Ammiak 1 A274

Ammine or ammoniate and coordination 1

A275–A286

- prepn of amines 1 A276
- properties of expl metal amines (table A to F) 1 A277–A282
- uses of amines 1 A277

Ammissible (Ital) 1 A286

Ammoksil 1 A286

Ammon (Ger) 1 A286

Ammonal (USA) 1 A287–A292

- compn and uses of Ammonals as comml expls 1 A288–A289
- compn and uses of Ammonals as mil expls 1 A288–A292
- historical and properties of Ammonal 1 A287–A288
- prepn of Ammonals 1 A288

Ammonals, analytical procedures 1 A292–A293

- identification of Ammonals 1 A292
- quant analysis Ammonals 1 A292–A293
- quant procedure for Ammonals used at PA 1 A293

Ammoncarbonites 1 A293

Ammoncohusit 1 A293

Ammondynamit 1 A293

Ammondyne 1 A293

Ammonex 1 A293–A295

Ammongelatine 1 A295

Ammongelative Dynamit 1 A295

Ammongelignite 1 A295

Ammongelit 1 1 A295

Ammonia (anhydr and aq) 1 A296–A302

Ammonia, analytical procedures 1 A303–A305

- I. ammonia, anhydr, synthetic 1 A303–A304
- II. ammonia, aq, analytical procedures 1 A304

Ammoniacal liquor 1 A305

Ammoniacal saltpeter plastic expl 1 A305

Ammoniacal silver compds and their solvents 1 A305–A306

Ammoniacate (Fr) 1 A306

- Ammonia derivs of polynitroalcohols 1 A306
- Ammonia Dynamites 1 A306
- Ammonia gelatin A 1 A306
- Ammonia gelignite 1 A306
- Ammonials (Ger) 1 A306
- Ammoniakat (Ger) 1 A306
- Ammoniakkрут 1 A306–A307
- Ammonia nitrate (poudre) 1 A307
- Ammonia oxidn 1 A307
- Ammoniaque (Fr) 1 A307
- Ammoniaque (Dynamit a) (Fr) 1 A307
- Ammonique Dynamite 1 A307
- Ammonite 1 A307–A310
- Ammonite goudronite 1 A310
- Ammonium azide 1 A521
- Ammonium azide ammonates 1 A521–A522
- Ammonium chlorate 2 C184–C185
- Ammonium chlorite 3 C245
- Ammonium chloride 3 C236–C237
- Ammonium chromate 3 C275–C276
- Ammonium compds 1 A310
- Ammonium dichromate 3 C283–C284
- Ammonium hexanitrocobaltrate 1 A310
- Ammonium, metal 1 A310
- Ammonium mononitroresolsulfonate 3 C558
- Ammonium nitrate (AN or amm nitrate)
1 A311–A340
 historical (AN) 1 A312–A313
 methods of evaporation of AN solvents
 1 A314–A318
 prepn of AN 1 A313–A318, A340
 properties of AN 1 A311–A313, A318–A334
 uses of AN 1 A334
- Ammonium nitrate blasting expls, high expls and
proplnts 1 A341–A354
 AN blasting expls 1 A341–A354
 AN expls contg detonable sensitizers 1 A346
- Ammonium nitrate blasting expls (cont'd)
 AN expls contg nondetonable sensitizers
 1 A346–A349
 AN high expls 1 A345–A346
 AN proplnts 1 A349–A350
 Explosifs de Favier 1 A352
- Ammonium nitrate Dynamite (AND) 1
 A355–A356
- Ammonium nitrate explns, fires, and hazards
 1 A357–A363
- Ammonium nitrate fertilizer grade (FGAN)
 1 A364–A367
- Ammonium nitrate gelatin (ANG) 1 A367–A368
 compn and properties of various ANG's 1 A368
- Ammonium nitrate, analytical procedures 1
 A369–A378
 detn of AN by nitrometer method 1
 A376–A378
 prepn of nitrometer for standardization and
 tests on AN 1 A373–A374
 qual tests for AN 1 A369
 quant tests for AN 1 A369–A373
 standardization of nitrometer to test 1
 A374–A376
- Ammonium nitrate, analytical procedures used by
the Spencer Chem Co, Kansas City, MO 1
 A378–A379
 AN prills, unparted 1 A379
 AN soln 1 A378–A379
- Ammonium nitrides 1 A380
- Ammonium nitrite 1 A380
- Ammonium salts of aromatic nitro compds such as
nitrophenol, m-nitroresol or of Picric Acid
 1 A381
- Ammonium salts, quarternary 1 A381
- Ammonium salts which are expl 1 A381
- Ammonium tetrachromate 3 C288–C289
- Ammonium trichromate 1 A288
- Ammonium trinitrate and ammonium dinitrate
 1 A381
- Ammonium ulmate 1 A381–A382
- Ammonkarbonit 1 A382

- Ammon-Nobelit 1 A382
 Ammono-basic lead nitrate 1 A382
 Ammonolysis 1 A382
 Ammonpek 1 A382
 Ammonpentrit 1 A382
 Ammonpulver 1 A382
 Ammons 1 A286
 Ammonsalpeter (Ger) 1 A382
 Ammonsalpetersprengstoffe (Ger) 1 A382
 Ammon semi-gelatine 1 A382–A383
 Ammonsprenggelatine 1 A383
 Ammonsulfatsalpeter (Ger) 1 A383
 Ammontol 1 A383
 Ammonyaku 1 A383
 Ammunition and weapons or arms 1 A383–A391
 aircraft ammo 1 A384
 artillery ammo 1 A383
 bombs 1 A384
 calibers and uses of artillery ammo and rockets
 (USA) 1 A386–A387
 calibers and uses of small arms ammo (USA)
 1 A386
 demolition materials 1 A384
 grenades 1 A384
 guided missiles 1 A384
 jatos 1 A384
 land mines 1 A384
 miscellaneous ammo 1 A385
 pyrot ammo 1 A384
 rocket ammo 1 A384
 small arms ammo 1 A383
 Ammo component 1 A391
 Ammo inspection 1 A391
 Ammo, self-destroying 1 A391
 Amonal 1 1 A391
 Amorage (Fr) 1 A391
 Amorage (Explosif d') (Fr) 1 A391
 Amorce 1 A391
 Amorce detonateur (Fr) 1 A391
 Amorce électrique (Fr) 1 A391
 Amorce fulminate (Fr) 1 A391
 Amorce a percussion (Fr) 1 A391
 Amperometric titration 1 A392
 Amphibious devices for tanks 1 A392
 DD device 1 A392
 Amphibious vehicles 1 A392–A393
 BARC 1 A393
 DUKW 1 A393
 Amphoteric substance 1 A393
 Amphtrack 1 A393
 Ampoule (chem) 1 A393
 AMR-2504 1 A393
 AMT-2035AX-3; AMT-2091-AX; AMT-2096-4AX;
 AMT-2106-AX, and AMT-2109-BT 1 A393
 AMTB 1 A393
 Amvis (expl) 1 A393
 Amyl acetates 1 A393-A394
 iso-Amylacetyl azide 1 A394
 Amyl alcohols 1 A394–A395
 Poudre B (proplnts) 1 A395
 Amylene and derivs 1 A395–A396
 amylazide 1 A395–A396
 amyleneozonide 1 A396
 amylether 1 A396
 (α -nitroisoamyl)-isonitramine 1 A395
 Amylguanidine and derivs 1 A396
 1-nitro-3n-amylguanidine (NAmGu) 1 A396
 Amylmalonylazidic acid 1 A396
 Amyl nitrate (mixed isomers) 1 A397
 Amyl nitrite 1 A397
 Amylodextrin 1 A397
 Amyloid 1 A398
 Amylopectin 1 A398
 Amylose 1 A398–A399
 iso-Amylpicrate 1 A399
 iso-Amylureidoacetyl azide 1 A399
 Amyrin 1 A399
 AN same as Ammonium Nitrate 1 A311–A340

- AN-507 1 A400
- Anac (Ger) 1 A400
- AN-525; AN-525J; AN-557; AN-565J; AN-579Y;
AN-581W; AN-583AF; AN-584J 1 A400
- AN-586Y; AN-628BF; AN-2011; AN-2017;
AN-2030; AN-2035AX; AN-2502EB 1 A400
- Anagon powder 1 A400
- Analinchlorates 1 A406
- "Analmatic" 1 A400
- Analytical chemistry 1 A400--A401
- Analytical procedures for delay compn for delay
elements T6E4 and T5E4 4 D1069
- Analytical procedures for expl compound used in
detonators, primers, igniters, and fuzes 4
D1060--D1078
- Analytical procedure for friction compn for
blasting fuse, friction type, M3A1 4 D1071
- Analytical procedure for igniter K29 4 D1071
- Analytical procedure for igniter compn for
blasting fuse; friction type, M3A1 4 D1070
- Analytical procedure for igniter compn for M31
series detonators 4 D1071
- Analytical procedure for igniter compn type 1
of delay charge compn F33B 4 D1067
- Analytical procedure for igniter compn type II
of delay charge compns Z-2A or Z-2B 4 D1068
- Analytical procedure for igniter, primer, electric,
M74 4 D1066
- Analytical procedure for primer mix 4 D1066
- Analytical procedure for priming compn (lead
starter type) 4 D1065
- Analytical procedure for primer mix for M3
ignition cartridge 4 D1063
- Analytical procedure for primer mix in the M29A1
percussion primer 4 D1064
- Analytical procedure for primer mix V 4 D1061
- Analytical procedure for primer mix new no 4
4 D1060
- Analytical procedure for primer mix no 70
4 D1062
- Analytical procedure for primer mix NOL no 130
4 D1063
- Analytical procedure for primer mix PA-100
4 D1063
- Analytical procedure for primer, percussion,
M39A1 4 D1061
- Analytical procedure for primer mix US army
standard 4 D1060
- Analytical procedure for tracer R-45 4 D1074
- Anasite 1 A401
- ANB 1 A401
- Anbenyaku 1 A401
- Anchorite 1 A401
- AND same as Ammonium nitrate Dynamite
1 A355--A356
- Anderson's expls 1 A401
- Andre's expl 1 A402
- ANE 1 A402
- Anello di forzamento (Ital) 1 A402
- Anello graduato (Ital) 1 A402
- Anello superiore della poletta (Ital) 1 A402
- Anesthetic agents, ignition, and expln of 1 A402
- Anethole 1 A402
- ANF-58 1 A402
- ANG same as Ammonium nitrate gelatin 1
A367--A368
- Angayaku 1 A402
- Angeli, Angelo 1 A403
- Angeli test 1 A403
- Angstrom, A.J. 1 A403
- ANH 1 A403
- Anhydro-(benzoic acid-2-diazoniumhydroxide)
2 A403
- Anhydro-[cotarnine-(2,4,6-trinitrotoluene)]
1 A403
- Anhydrodiacetoneurea 1 A403--A404
trinitroanhydrodiacetone-urea 1 A403--A404

- Anhydroenneaheptitol and derivs 1 A404
 anhydroenneaheptitol pentanitrate (AEHP)
 1 A404
- Anhydroformaldehydeaniline and derivs 1 A404
 nitroanhydroformaldehydeaniline 1 A404
- Anhydroglucose 1 A404–A405
- Anhydrohydrastinine-[2,4,6-trinitrotoluene]
 1 A405
- Anhydro-(4-hydroxy-3-carboxy-azobenzene-4'-
 diazoniumhydroxide) 1 A405
- Anhydro-(3-nitrobenzoic acid-4-diazonium-
 hydroxide) 2 B76
- Anhydro-(6-nitro-2,5-dihydroxy-p-benzoquinone-
 3-diazo-hydroxide) 5 D1290
- Anhydro-(7-oxy-4-methylcumarin-8-diazonium-
 hydroxide) 1 A405
- 3,6(?) -Anhydro-D-sorbitol 1 A405
- Anilides 1 A405
- Aniline (phenylamine) 1 A406–A414
 N-alkylnitroanilines 1 A408
 dinitroanilines (DNA) 1 A408–A409
 mononitroanilines 1 A407–A408
 nitrated derivs of aniline 1 A407
 2,3,4,5,6-pentanitroaniline (PNA) 1 A414
 salts of aniline with inorganic acids 1
 A406–A407
 salts of aniline with organic compds 1 A407
 tetranitroanilines (TeNA) 1 A411–A412
 tetranitroaniline expls 1 A414
 trinitroanilines (TNA) 1 A409–A411
- Aniline and derivs analytical procedures 1
 A415–A419
 anilines, nitrated, analysis 1 A418
 anilines, polynitro derivs 1 A418–A419
- Anilinoacetic acid and derivs 1 A420
 2,4-dinitroanilinoacetic acid 1 A420
 mononitroanilinoacetic acid 1 A420
 2,4,6-trinitroanilinoacetic acid 1 A420
- Anilinoazobenzene and derivs 1 A420
 dinitroanilinoazobenzene 1 A420
 mononitroanilinoazobenzene 1 A420
 trinitroanilinoazobenzene 1 A420
- Anilinobenzenediazonium hydroxide and derivs
- Anilinobenzenediazonium hydroxide (cont'd)
 p-anilinobenzenediazonium nitrate 1 A421
 1-anilino-2,6-dinitrobenzene-4-diazonium salts
 1 A421
 1-(2,4-dinitroanilino)-benzene-4'-diazonium
 salts 1 A421
- Anilinobenzoic acid and derivs 1 A421–A422
 4-anilino-3,5-dinitrobenzoylazine 1 A422
 dinitroanilinobenzoic acid 1 A422
 mononitroanilinobenzoic acid 1 A422
- Anilinobenzonitrile and derivs 1 A422
 m-(2,4-dinitroanilino)-benzonitrile 1 A422
 nitroanilinobenzonitrile 1 A422
 m-(2,4,6-trinitroanilino)-benzonitrile 1 A422
- Anilinobutanol and derivs 1 A422–A423
 2-(2',4'-dinitroanilino-N)-1-butanol 1
 A422–A423
 2-(N,2',4',6'-tetranitroanilino)-1-butanol
 nitrate 1 A423
- Anilinobutyric acid and derivs 1 A423–A424
 2-(2',4'-dinitroanilino)-iso-butyric acid 1 A423
 2-(2',4',6'-trinitro-N-nitranilino)-iso-butyric
 acid 1 A423–A424
- Anilinoethanol and derivs 1 A424–A425
 2-(2',4'-dinitroanilino)-ethanol 1 A424–A425
 mononitranilinoethanols 1 A424
 2-(2',4',6'-trinitroanilino)-ethanol 1 A425
 2-(2',4',6'-trinitro-N-nitranilino)-ethanol
 nitrate (Pentryl) 1 A425–A429
- Anilinoethanol, halogen derivs 1 A430–A431
- Anilinoethylaminoethanol and derivs 1 A431
 N-[2-(2,4-dinitroanilino)-ethyl]-aminoethanol
 1 A431
 N-[2-(2,4,6-trinitroanilino)-ethyl]-aminoethanol
 nitrate 1 A431
- Anilino guanidine and derivs 1 A431–A432
 anilino guanidine nitrate 1 A431
 1-anilino-3-nitroguanidine 1 A431–A432
 N-anilino-N'-nitroguanidine 1 A432
- Anilinoindazole and derivs 1 A432
 5,7-dinitro-6-anilinoindazole 1 A432
 5,7-dinitro-6-(2',4',6'-trinitroanilino)-indazole
 1 A432
 6-(2',4',6'-trinitroanilino)-indazole 1 A432
- Anilinomethylpropanediol and derivs 1 A433

- Anilinomethylpropanediol (cont'd)
 2-(2',4'-dinitroanilino)-2-methyl-1,3-propanediol 1 A433
 2-(2',4',6'-trinitro-N-nitranilino)-2-methyl-1,3-propanediol dinitrate 1 A433
- Anilinophenol and derivs 1 A433
 dinitroanilinophenols 1 A433
 dinitronitroanilinophenols 1 A433
 mononitroanilinophenols 1 A433
 trinitroanilinophenols 1 A433
- Anilinophenyltetrazole and derivs 1 A433—A434
- Anilinophthalimide and derivs 1 A434
 N-(2',4'-dinitroanilino)-3-nitrophthalimide 1 A434
- Anilinopropanediol and derivs 1 A434—A436
 dinitroanilinopropanediols 1 A434—A435
 trinitroanilinopropanediols 1 A435
 trinitro-N-nitroanilinopropanediol dinitrates 1 A435—A436
- Anilinopropanol and derivs 1 A436
 chloronitroanilinopropanols 1 A436
 dinitroanilinopropanols 1 A436
 mononitroanilinopropanols 1 A436
- Anilinopropionic acid and derivs 1 A436—A437
 dinitroanilinopropionic acids 1 A436—A437
 mononitroanilinopropionic acids 1 A436
- Anilinosuccinic acid and derivs 1 A437
- Anilinetetrazole and derivs 1 A437—A438
 5-(2',4'-dinitroanilino)- α (or 1H)-tetrazole 1 A437
 5-nitroanilino-X (or 1H)-tetrazole 1 A437
 5-(2',4',6'-trinitroanilino)- α (or 1H)-tetrazole 1 A437—A438
- Anilinetoluene; diphenylmethylenes and derivs 1 A438—A440
 dinitroanilinetoluenes; dinitrodiphenylmethylenes 1 A438
 2,4,6,2',4',6'-hexanitro-N-methyl-diphenylamine 1 A440
 mononitroanilinetoluenes; nitrodiphenylmethylenes 1 A438
 tetranitroanilinetoluenes; tetranitrodiphenylmethylenes 1 A439—A440
 trinitroanilinetoluenes; trinitrodiphenylmethylenes 1 A438—A439
- Anilinetriazole and derivs 1 A440—A441
 nitrosoanilinetriazole 1 A440
- Anilinetrimethylolmethane and derivs 1 A442
 2,4-dinitroanilinetrimethylolmethane 1 A441
 N-(2,4,6-trinitro-N-nitranilino)-trimethylolmethane trinitrate (Heptryl) 1 A441—A442
- Anilinovaleric acids and derivs 1 A442
 dinitroanilinoisovaleric acid 1 A442
 α -(2,4,6-trinitroanilino)-isovaleric acid 1 A442
- Anilinoxylene and derivs 1 A443
 dinitroanilinoxylenes 1 A443
 hexanitroanilinoxylenes 1 A443
 mononitroanilinoxylenes 1 A443
 trinitroanilinoxylenes 1 A443
- Anilite 1 A442
- Anilite or Anilite 1 A443—A444
- Anilite or anilite 1 A442—A443
- Anima (Ital) 1 A444
- Anima lascia (Ital) 1 A444
- Anima rigata (Ital) 1 A444
- Anisalanishydrazide azide 1 A444
- Anisaldehydes and derivs 1 A444—A445
 p-anisaldehyde perchlorate 1 A445
 dinitroanisaldehydes 1 A444—A445
 monitroanisaldehydes 1 A444
- Anisaldehydephenylhydrazone and derivs 1 A445—A446
 p-anisaldehyde-phenyl-hydrazone peroxide 1 A445
 dinitroanisaldehyde-phenyl-hydrazones 1 A445—A446
 nitroanisaldehyde-dinitro-phenylhydrazones 1 A445
 3-nitro-(p-anisaldehyde)-(4'-nitrophenylhydrazone) 1 A445
 3-nitro-(p-anisaldehyde)-phenylhydrazone 1 A445
- Anisic acids and derivs 1 A446—A447
 o-anisidino-diazido-copper 1 A447
 2-dinitroanisic acids 1 A446—A447
 mononitroanisic acids 1 A446
- Anisole and derivs 1 A448—A454
 dinitroanisoles (DNAs) 1 A448—A449
 mononitroanisoles (MNAs) 1 A448

- Anisole and derivs (cont'd)
 5-nitroso-2,4-dinitroanisole 1 A450
 tetranitroanisoles (TeNAns) 1 A454
 trinitroanisoles (TNAns) 1 A450–A453
 trinitroanisole complex 1 A453
- Anisole and derivs, analytical procedures 1
 procedures 1 A454–A456
 anisole 1 A454
 dinitroanisoles 1 A455
 mononitroanisoles 1 A454–A455
 tetranitroanisole 1 A456
 trinitroanisole 1 A455–A456
- Anisoylazide 1 A456
- Anisyl alcohol and derivs 1 A456–A457
 anisyl alcohol, nitrates 1 A456
 dinitroanisylalcohols 1 A456–A457
 mononitroanisylalcohols 1 A456
- Anisyltetrazole and derivs 1 A457
 5-[3'-nitro-4'-methoxyphenyl]-tetrazole
 1 A457
- ANJ 1 A457
- AN-M-69 1 A457
- ANP-512DS, ANP-514DO, ANP-528DV,
 ANP-2502-EB, ANP-2512EE, ANP-2541CD,
 ANP-2566EN & ANP-2569EK 1 A457
- ANS or antisanzinate 1 A457
- Anschütz thermometers 1 A457
- Ansonit caps 1 A457
- ANT-623 & ANT-638 BV 1 A457
- Anthracene and derivs 1 A457–A458
 anthracene peroxide 1 A458
 dinitroanthracenes 1 A458
 mononitroanthracenes 1 A458
- Anthrachrysonone and derivs 1 A458–A459
 dinitroanthrachrysonones 1 A458
 2,4,6,8-tetranitro-1,3,5,7-tetrahydroxyanthra-
 quinone 1 A458–A459
- Anthracite 1 A459
- Anthracite particles (coal dust) 1 A459
- Anthramine and derivs 1 A459
 mononitroanthramines 1 A459
- Anthraquinone and derivs 1 A459–A460
 anthraquinone azides 1 A459
- Anthraquinone (cont'd)
 anthraquinone diazide 1 A459–A460
 β -anthraquinonesulfonazide 1 A460
 2,6-diazidoanthraquinone 1 A460
 1,5-dinitro-2,6-diazidoanthraquinone 1 A460
 nitroanthraquinones 1 A460
 nitroazidoanthraquinone 1 A460
- Antiacid compds 1 A460–A461
- Antiaircraft (AA) 1 A461
- Antiaircraft gunfire control systems 1 A461
- Antiaircraft proj charges of Willing 1 A461
- Anticaking treatment of expls and substances
 used in expl compns 1 A461
- Anticarro (Ital) 1 A461
- Antichar (Fr) 1 A461
- Anticracking additives to cast expls 1 A461–A462
 additives used 1 A462
- Antidetonating or antiknock compds 1
 A462–A463
- Antifoaming or antifrothing agents 1 A463–A464
 frothiness testing of TNT 1 A463–A464
- Antifreezes and their uses in expls 1 A464–A466
- Antifrost celladyne 1 A466
- Antifrost gelamonite no. 1 1 A466
- Antifrost Penryhn powdr 1 A466
- Antifume blasting gelatin 1 A466
- Antigel de Sûreté 1 A466
- Antigrisou D'Arendonck 1 A466
- Antigrisou (explosivs) 1 A466–A467
- Antilueur (Fr) 1 A467
- Antimony 1 A467–A470
 antimony, analytical proc 1 A469–A470
 antimony, expl 1 A468, A469
 antimony, pyrot compn 1 A468
- Antimony chloride 3 C237
- Antimony triazide 1 A522
- Anti-motor-torpedoboat (AMTB) 1 A470–A471
- Antioxidants 1 A471

- Antipyrene and derivs 1 A471–A472
 antipyrene complexes with nitrates of some rare earth metals 1 A471
 antipyrene complexes with perchlorates of some rare earth metals and some other metals 1 A471
 4-azidoantipyrene 1 A471
 dinitroantipyrenes 1 A472
 mononitroantipyrenes 1 A471
 nitroantipyrene nitrates 1 A472
 nitroantipyrene picrates 1 A472
 nitronitrosoantipyrenes 1 A472
 nitrosoantipyrene 1 A472
- Antisanzionite (Ital) 1 A472
- Antisubmarine weapons 1 A472
- Antitank (A/T) ammo and weapons 1 A472–A473
- Antonite cava 1 A473
- Antonite galleria extra 1 A473
- ANU 1 A473
- Anvil of a percussion primer 1 A473
- AOE; AOK; AOR; AOV 1 A473
- AP same as Armor-piercing projectile 1 A483–A485
- Apache coal powder 1 A473
- Apache Powder Co 1 A473
- APC same as Armor-piercing capped 1 A483
- APC same as Atlas Powder Co 1 A498
- Äpfelsäure (Ger) 1 A473
- Aphosite 1 A473
- Apigenin and derivs 1 A473–A474
 mononitroapigenins 1 A473
 tetranitroapigenins 1 A474
 trinitroapigenins 1 A474
- Aplastic anemia and toxic hepatitis 1 A474
- Apparatus for blasting coal 1 A474
- Apparatus for indicating the presence of explosive or flammable vapors or gases 1 A474
- Apparatus (lab) for continuous preps of expls 1 A474
- Apparechio (Ital) 1 A474
- Apprechio nebbiogeno (Ital) 1 A474
- Appareil (Fr) 1 A474
- Appareil d'écoute (Fr) 1 A474
- Appareil de pointage (Fr) 1 A474
- Apparent ignition temp in air see Spontaneous combustion 9 S202
- Applied analysis 1 A474
- Applied chemistry and applied chemical analysis 1 A474–A475
- Appoint 1 A475
- APQ 1 A475
- Aprotic solvents 1 A475
- Aptitude à la déflagration (Fr) 1 A475
- Aptitude à la déflagration par choc mécanique (Fr) 1 A475
- Aptitude à la detonation (Fr) 1 A475
- Aptitude à l'inflammation epreuve (Fr) 1 A475
- Aptitude à l'inflammation, essai (test) 1 VII, IX, X
- APU 1 A475
- APX expls 1 A475
- Apyrite 1 A475
- AQG; AQL; AQN; AQO 1 A475
- Aquadag 1 A475
- Aquametry 1 A475–A476
- Aqua regia 1 A476
- ARA 1 A476
- Arabinose and derivs 1 A476
 arabinose tetranitrate 1 A476
- Arabitol and derivs 1 A476–A477
 arabitol pentanitrate 1 A476–A477
- Araldite 1 A477
- Aranaz, Ricardo 1 A477
- ARB 1 A477
- Arbalest or crossbow 1 A477
- Archery 1 A477
- Arcites 1 A477

- Arcites 251, 309, 358, 362 and 368 1 A477
 Ardeer cordite 1 A477
 Ardeer plant 1 A477
 Ardeer powder 1 A477
 ARE same as Armament Research Establishment 1 A481
 AREC same as Armament Research Establishment, Canada 1 A481
 ARERA same as Armament Research Establishment, Royal Arsenal 1 A481
 ARF same as Armour Research Foundation 1 A485
 Argarit 1 A477
 Argent fulminant de Berthollet (Fr) 1 A477
 Argentine armament 1 A477–A480
 abbreviations 1 A480
 Argentine civilian-owned munitions plants 1 A479–A480
 Argentine government-owned munitions plants 1 A478
 armament of the Argentine army 1 A478
 Argol 1 A480
 Argonit 1 A480
 Argus 1 A480
 Arkite 1 A480
 Arlberg dynamite 1 A480–A481
 Arma (Ital) 1 A481
 Arma bianca (Ital) 1 A481
 Armada (Span) 1 A481
 Arma da fuoco (Ital) 1 A481
 Armament 1 A481
 Armament engineering 1 A481
 Armament Res Establishment (ARE) 1 A481
 Armament Research Establishment, Canada (AREC) 1 A481
 Armament Research Establishment, Royal Arsenal (ARERA) 1 A481
 Armamento (Ital & Span) 1 A481
 Arme (Fr) 1 A481
 Armé (Fr) 1 A481
 Arme à chargement par la culasse (Fr) 1 A481
 Armed force 1 A481
 Armée (Fr) 1 A481
 Armée de l'air (Fr) 1 A481
 Armée de mer (Fr) 1 A481
 Armée de terre 1 A481
 Armée mécanique (Fr) 1 A481
 Arme à feu (Fr) 1 A481
 Arme à feu automatique 1 A481
 Arme portative 1 A481
 Armeria (Ital) 1 A481
 Arming 1 A481
 Armor 1 A481–A482
 Armored car (mil) 1 A482
 Armored ships 1 A482
 Armored train 1 A482–A483
 Armor-piercing (AP) projectiles 1 A483–A485
 armor-piercing hollow projectiles 1 A483–A484
 shaped charge projectiles 1 A484
 solid shot 1 A483
 Armor plate impact test 1 VII
 Armor testing 1 A485
 Armour Research Foundation (ARF) 1 A485
 Armory 1 A485
 Armstrong airbreaker 1 A485
 Armstrong gun 1 A485
 Armstrong's expl or mixt 1 A485
 Army 1 A485
 Army Ordnance Corps (US) 1 A485–A486
 Arnoudts' expl 1 A486
 ARO 1 A486
 Aroclor 1 A486
 Aromatic-aliphatic nitrocompds and nitrate esters 1 A486

- Aromatic alkylamino alcohols **1** A486–A487
 Aromatic compds **1** A487
 Aromatic diazo compds and their technical application **1** A487
 Aromatic hydrocarbons, detection in aq solns **1** A487
 Aromatic, nitrated derivs **1** A487
 Aromatic, nitrited derivs **1** A487–A488
 Aromatic peracids see Peroxides **8** Table 6, P202, Peroxy acids **8** P212–P214
 Aromatic silanes see Silanes and derivs **9** S85–S88
 Aromatic substitution-nitration and halogenation **1** A488
 Aromatic triazenes **1** A488 see Triazines **9** T352–T358
 ARP **1** A488
 Arquebus or harquebus **1** A488
 Arrested burning of gun proplnts **1** A488
 Arrosage des poudres (Fr) **1** A488
 Arrow **1** A488
 Arrow projectile **1** A488–A489
 Arrowhead projectiles **1** A489
 Arrowroot **1** A489
 ARS **1** A489
 Arsenal **1** A489–A490
 Arsenic **1** A490
 Arsenic triazide **1** A522
 Arsenic trichloride **3** C237
 Arsenides **1** A490–A491
 magnesium arsenide **1** A491
 Arsenium carbide **1** A70
 Arsine and derivs **1** A491
 Adamsite **1** A491
 arsine derivs, organic **1** A491
 Clark I and II **1** A491
 Dick **1** A491
 Lewisite **1** A491
 Arsol **1** A491
 ART **1** A491
 Artifice (Fr) **1** A491
 Artifices (Fr) **1** A491
 Artifices à fumées colorées (Fr) **1** A491
 Artifices de guerre (Fr) **1** A491
 Artifices incendiaires (Fr) **1** A491
 Artifices lumineux (Fr) **1** A491
 Artifices de signalisation (Fr) **1** A492
 Artifices pour signaux (Fr) **1** A492
 Artifices produisant un sifflement (Fr) **1** A491–A492
 Artificial barricade **1** A492
 Artificial silica **1** A492
 Artifizii da guerra (Ital) **1** A492
 Artifizii pirotecnici per usi bellici **1** A492
 Artiglieria (Ital) **1** A492
 Artilleria (Span) **1** A492
 Artillerie (Fr & Ger) **1** A492
 Artillériya (Rus) **1** A492
 Artillery **1** A492
 Artillery ammo components tests **1** A492
 Artillery ammo, description of various types of **4** D777
 Artillery and some other projectiles including their initiating components **4** D810–D879
 Artillery cannon and cannon equipment **1** A492
 Artillery carriages and mounts, etc. **1** A492
 Artillery fuzes **4** D885
 Artillery fuzes, base-detonating **4** D913
 Artillery fuzes, mechanical time (MT) and mechanical time-superquick (MTSQ) **4** D906
 Artillery fuzes of WWII, foreign **4** D923
 Artillery fuzes, point detonating **4** D887
 Artillery fuzes, proximity or VT (variable time) **4** D918
 Artillery materiel and its testing **1** A492–A493

- Artillery primer-igniters, detailed description of
 4 D792
- Artillery projectiles, definition of terms used for
 initiating components of 4 D836
- Artillery proplnt primers or primer-igniter 4 D775
- Artillery, railway 1 A493
- Artillery train 1 A493
- Arukōru (Jap) 1 A493
- Aruminyūmu 1 A493
- Arylamines, qual reactions 1 A493
- Arylparaffins 1 A493
- ARZ 1 A493
- ASA 1 A493
- Asbestos 1 A493–A494
- Ascaridol 1 A494
- ASG 1 A494
- Ash 1 A494
- Ash detn 1 A494–A496
 - of an expl 1 A495
 - of an expl contg liquid 1 A495–A496
 - of a non energetic material 1 A494–A495
 - of a proplnt 1 A495
- ASN 1 A496
- Asphalines 1 A496
- Asphalt 1 A496–A497
- Asphalt-perchlorate castable proplnts 1 A497
- Assisted take-off (units) (JATO) 1 A497
 - JATO 1 A497; 7 J67
 - RATO 2 A497; 9 R117
- AST 1 A497
- Aston, Francis W. 1 A497
- Astralits 1 A497–A498
- Astrodyne synthetic rubber proplnt 1 A498
- Astronautics 1 A498
- AT 1 A498
- A/T see as Antitank ammo and weapons 1
 A472–A473
- ATJ 1 A498
- Atlas 1 A498
- Atlas Dynamite 1 A498
- Atlas Powder Co (APC) 1 A498
- Atlas powders 1 A498–A499
- ATN 1 A499
- Atomic (or nuclear) bomb 1 A499–A500
- Atomic (or nuclear) energy; atomic (or nuclear)
 reactions; atomic (or nuclear) explns 1
 A500–A504
- Atomic weapons and ammo 1 A504–A505
 - atomic artillery 1 A504
 - atomic rifle 1 A504
 - atomic rockets 1 A504
 - atomic shell 1 A504
 - nuclear fission rocket 1 A504–A505
- Atomization 1 A505–A506
 - electric atomization 1 A505
- ATT (attenuated ballistite) 1 A506
- Attasorb 1 A506
- Attenuating materials. Effects of detonation
 induction distances in gases 1 A506
- Attenuation 1 A506
- Attrition mill 1 A506–A507
- ATX same as 1,7-Dinitroxy-1,3,5,7-tetramethylene-
 2,4,6-triamine 5 D1295–D1296
- 5-ATZ same as 5-Amino- α -tetrazole 1
 A258–A262; 9 T116
- Audemars expls 1 A507
- Aufschläger, Gustav 1 A507
- Augendre powder 1 A507
- AUN 1 A507
- “Aunt Jemima” expl 1 A507–A508
- Auramine and derivs 1 A507–A508
 - auramine hydrochloride 1 A507–A508
- Aurine and derivs 1 A508–A509
 - aurine perchlorate 1 A509
 - tetranitroaurine 1 A509
- Aurum fulminans 1 A509

- Austin Powder Co 1 A509
 Austrian ammo, expls and weapons 1 A509
 Austrian proplnts of WWI 1 A509–A510
 Austrian warplants, arsenals, etc 1 A510
 Authorized or acceptable expls 1 A510
 Autoclaves 1 A510
 Autofrettage; self-hooping or cold-working 1 A510
 Autoignition temps of organic and inorg powders
 in air 1 A511
 Automatic computers and calculators 1 A511
 Automatic feed mechanism 1 A511
 Automatic (self-acting) weapon 1 A511–A512
 Automation . . . automatic process control 1 A512
 Autopropulsion 1 A511–A512
 Autoxidation 1 A513
 Autoxygen Co process of nitration 1 A513
 Autozone 1 A513
 AUV 1 A513
 Auxoexplode or auxoplosophore; explosophore or
 plosophore 1 A513–A514
 "Available diphenylamine" 1 A514–A515
 Available energy 1 VII, XIX
 Available HNO₃ 1 A515
 Available oxygen; active oxygen, effective oxygen;
 oxygen balance to CO₂ and CO 1 A515–A516
 see Oxygen balance 8 O57–O62
 Available stabilizer (diphenylamine and/or ethyl
 centralite) in aged or stored proplnts 1 A516
 Aviation gasoline—expl characteristics 1 A516
 Avigliana Dynamite factory 1 A516
 Axial initiation of multicomponent expl charges
 4 D140
 Axtite 1 A516
 Az 1 A516
 Aza 1 A516–A517
 Azacyclo 1 A517
 3-Aza-4-oxa-2-hexene, 2,5,5-trinitro 1 A517
 Azaurolic acids 1 A517–A518
 "azdioxdiazin" 1 A517–A518
 ethylazaurolic acid 1 A517
 methylazaurolic acid 1 A517
 Azeotrope 1 A518
 Azeotropy 1 A518
 Azete 1 A518
 Azetidine and derivs 1 A518–A519
 3,3-dinitroazetidine 1 A519
 1-nitrosoazetidine 1 A519
 2-Azetidinone 1 A519
 Azides, inorganic 1 A520 see Hydrozoic acid 1
 A539–A540
 Azides, inorganic (list) 1 A521–A625
 aluminum triazide 1 A521
 ammonium azide 1 A521
 ammonium azide ammonates 1 A521–A522
 antimony triazide 1 A522
 arsenic triazide 1 A522
 barium diazide 1 A523–A524
 beryllium diazide 1 A524–A525
 bis (hydroxylamino) azide 1 A525
 bismuth triazide 1 A525
 boron triazide 1 A525
 bromine azide 1 A525–A526
 cadmium diazide 1 A527
 calcium diazide monohydrazinate 1 A527
 calcium diazide dihydrazinate 1 A528
 carbonyl diazide 1 A528
 cerium hydroxydiazide 1 A528
 cerium triazide 1 A528
 cesium azide 1 A528–A529
 chlorine azide 1 A529–A530
 chromium triazide 1 A530
 chromium azide complexes 1 A530–A531
 cobalt triazide 1 A531
 cobalt azide complexes 1 A531–A532
 cupric azide 1 A532–A533
 cupric ammunoazide 1 A533
 cupric azide, basic 1 A533
 cupric azide complexes 1 A533–A534
 cuprous azide 1 A534–A535
 fluorine azide 1 A536
 gallium triazide 1 A536
 gold azide 1 A536
 hydrazine azide 1 A536–A537

Azides, inorganic (list) (cont'd)

- hydrazine azide monohydrazinate 1 A537
- hydrazine azide hemiammonate 1 A537
- hydrogen azide and hydrozoic acid 1 A537–A542
- iodine azide 1 A542–A543
- iron azide 1 A543–A544
- lanthanum triazide 1 A544
- lead azide (LA) 1 A545–A587
- lead azide plant, analyt proc 1 A563–A587
- lithium azide 1 A588–A589
- magnesium diazide 1 A589
- manganese diazide 1 A589–A590
- mercuric azide 1 A590–A591
- mercurous azide 1 A591–A592
- nickel diazide 1 A592–A593
- nitrosyl azide 1 A594
- phosphorus-nitrogen azide 1 A594
- potassium azide 1 A594–A596
- rubidium azide 1 A596–A597
- silicon tetrazide 1 A597
- silver azide 1 A597–A601
- sodium azide 1 A601–A612
- sodium azide plant, analyt proc 1 A612–A619
- strontium diazide 1 A620–A621
- sulfuryl diazide 1 A621
- thallium azide 1 A621–A623
- thallous-thallic azide 1 A623–A624
- tin azide 1 A624
- zinc diazide 1 A624–A625

Azides, organic 1 A626–A627

- acyl azides 1 A626
- alkyl azides 1 A626
- aryl azides 1 A626
- azide salts 1 A626

Azides, organic (list) 1 A627–A643

- acetonetetrazylazide 1 A47
- acetyl glycine azide 1 A69
- acryloylazide 1 A97
- adipyldiazide 1 A104
- aleuritylazide 1 A123–A124
- alkylazides 1 A129–A130
- askyltetrazylazides 1 A133
- allophanylazide 1 A133–A134
- allyazide 1 A137
- o-aminoazidoacetophenone 1 A178
- aminobenzazide 1 A188–A189
- iso-amylacetylazide 1 A394
- amylazide 1 A395
- amylmalonylazide 1 A396

Azides, organic (list) (cont'd)

- iso-amylureidoacetyl azide 1 A399
- anilinobenzenediazonium azide 1 A421
- anilindinitrobenzoyl azide 1 A421
- anisalanishydrazide azide 1 A456
- anthranilic acid azide 1 A188–A189
- anthranoylazide 1 A189
- anthraquinone azide 1 A459
- azidine 1 A627–A628
- azidoacenaphthene 1 A12
- azidoacetaldehyde 1 A15
- azidoacetamide 1 A16
- azidoacetamidophenol 1 A20–A21
- azidoacetamidophenol, dinitro 1 A21
- azidoacetanilide 1 A23
- azidoacetate 1 A628
- azidoacetic acid 1 A27
- azidoacetic anhydride 1 A31
- azidoacetone 1 A39
- azidoacetoneacetylhydrazide 1 A39
- azidoacetone nitrile 1 A45
- azidoacetonylditetrazole 1 A47
- azidoacetonyltetrazole 1 A47
- azidoacetophenone 1 A47–A48
- azidoacetophenoneoxime 1 A49
- azidoacetoxime 1 A51
- azidoacetyl-dl-alanine 1 A54
- azidoacetyl-dl-alanine chloride 1 A54
- azidoacetyl chloride 1 A57
- azidoacetyldiphenylamine 1 A58
- azidoacetylglycine 1 A69
- azidoacetylhydrazide acetone 1 A39
- azidoacetylsalicylic acid 1 A87
- azidoacrylic acid 1 A97
- azidoamide 1 A628
- azidoaminoacetophenone 1 A178
- azidoaminobenzoid acid 1 A188–A189
- azidoaminoethane 1 A199
- azidoaminomethylguanidine 1 A232
- azidoaminopropane 1 A250
- azidoaminothiadiaazole, nitroso 1 A262
- azidoaniline and derivs 1 A629
- azidoanisole and derivs 1 A629–A630
- azidoanthraquinone 1 A459–A460
- azidoantipyrine 1 A471
- azidoazobenzene 1 A647
- azidoazomethine-tetrazole equilibrium 1 A630
- p-azidobenzaldehyde 1 A630
- azidobenz-anti-aldoxime, methyl ester 1 A630
- azidobenzene 1 A630
- azidobenzenediammoniumhydroxide 1 A630

Azides, organic (list) (cont'd)

- azidobenzenedioxime 1 A630
 azidobenzoic acid hydrazonium hydroxide 1 A630
 azidobenzoic acid, methyl ester 1 A630
 azidobenzonitrile 1 A630
 N-[(α -azidobenzylidene)-N-benzylidene]-hydrazide 1 B35–B36
 4-[4-azidobenzylideneamino]-phenol 1 A630
 azidobromobenzene (1-bromo-4-triazobenzene) 1 A630
 1-azido-2-bromoethane 1 A630
 azido-5-bromonicotinic acid 1 A630 see Bromonicotinic acid and derivs 2 B314–B315
 1-azido-4 (or 5)-bromo-2-nitrobenzene 1 A630
 1-azidobutane 1 A630
 azidobutanoneoxime 1 A630
 α -azidobutyric acid 1 A630
 azidobutyric acid amide 1 A630 see Butyramide and derivs 1 B390–B391
 azidobutyric acid, ethyl ester 1 A630 see Butyric acid and derivs 2 B390
 azidobutyric acid hydrazide 1 A630 see Butyric acid and derivs 2 B390
 azidobutyric acid hydrazide 1 A630 see Butyric acid hydrazide 2 B390
 azidobutyrylazide 1 A630 see Butyric acid 2 B390
 azidocaffeine 1 A630; 2 C3
 3-azido-d-camphor 1 A630 see Camphor 1 C22–C23
 3-azidocarbazole 1 A630 see carbazole 2 C47
 azido carbon disulfide 1 A631 see Carbon disulfide monazide 2 C61
 azidocarbonyl diazonium hydroxide 1 A631
 azidocarboxyphenyloxamic acid 1 A631; 2 C66
 azidochloroethane 1 A631; 3 C254
 2-azido-3-cumaranone 1 A631; 3 C548
 azidocyanformamidine 1 A631; 3 C586
 azidocyaniminoaminomethane 1 A631
 azidocycloheptane 1 A631
 azidocyclohexane 1 A631; 3 C595
 azidocyclopentane 1 A631; 3 C603
 2-azido-4-diazobenzenesulfonic acid 1 A631; 5 D1158
 1-azido-1,2-dibromoethane 1 A631; 5 D1235
 azidodiethylether 1 A631
 azidodiethylsuccinate 1 A631
 azido-3,4-dihydroxy-2,5-furandicarbonyl 1 A631; 5 D1292

Azides, organic (list) (cont'd)

- azidodimethylaminobenzeneazotriazole 1 A631; 5 D1307
 azidodimethylazobenzene 1 A631
 azidodimethylbenzene 1 A631; 5 D1320
 azidodimethylbenzene 1 A631; 5 D1321
 azidodimethylbenzoic acid 1 A631; 5 D1326
 azidodimethyldinitrobenzene 1 A631 see 2-Azido-5-(tertbutyl)-4,6-dinitro-m-xylene 2 B390
 azidodimethylindazole 1 A631; 5 D1347
 azidodimethylnitrobenzene 1 A631; 5 D1322
 4-azido-3,5-dimethylpyrazole 1 A631; 5 D1370
 azidodinitroacetamidophenol 1 A21
 azidodinitrobenzene (dinitrophenyl azide) 1 A631; 2 B42–B43
 2-azidodinitrobiphenyl 1 A631; 2 B123
 azidodinitronaphthalene 1 A631; 8 N6
 2-azido-4,6-dinitrophenol 1 A631; 8 P229
 3-azido-2,4-dinitrophenylhydrazone propionate 1 A631
 azidodinitrotoluene 1 A631
 azidodinitroxylene 1 A631; 5 D1324
 azidodithiocarbonic acid and derivs 1 A632–A637
 azidoethane 1 A637; 6 E142
 azidoethanol 1 A637; 6 E177
 azido-p-ethoxyphenyl tetrazole 1 A637; 6 E194
 azidoethylene (vinyl azide) 1 A638
 azidoethylenediurethane 1 A638; 6 E234
 azidoethylmethylketonesemicarbazone 1 A638; 6 E312
 azidoethylnitrate 1 E638; 6 E142–E143
 N-[β -azidoethyl]-N'-phenylurea 1 A638; 6 E322
 azidoethylurea 1 A638; 6 E337
 [α -azidoethyl]-urethane 1 A638
 [β -azidoethyl]-urethane 1 A638
 azidofluorenone 1 A638; 6 F122–F123
 azidoformamide 1 A638; 2 C40
 azidoformamidine 1 A638; 6 F168
 azidoformamidine nitrate 6 F168
 azidoformamidine, N-nitro 6 F168
 azidoformamidine perchlorate 6 F168
 azidoformamidine picrate 6 F169
 azidoformic acid dimethylamide 1 A638; 6 F171
 azidoformic acid, ethylester 1 A638; 6 F171
 azidoformic acid, methylester 1 A638; 6 F171
 α -azidoformylbutyrylglycine azide 1 A638
 2-azidoformylphenylisocyanate 1 A638

Azides, organic (list) (cont'd)

β -azidofornylpropionylglycine azide 1 A638
 azidogallacetophenone 1 A639; 6 G9
 azidoglutamic acid glycine 1 A639; 6 G86
 azidoglycolic acid 1 A639; 6 G115
 3-azidoheptane 1 A639; 7 H62
 6-azido-2,3,5,2',4',5'-hexamethylazobenzene
 1 A639
 azidohexane 1 A639; 7 H87
 azidohydrocinnamic acid 1 A639; 7 H214
 azidohydroquinone 1 A639; 7 H228
 azidohydroxyacetophenone 1 A639; 7 H230
 azidohydroxymethoxybenzaldehyde 1 A639
 5-azido-3-[(2-hydroxy-1-naphthyl)-azo]-1,2,4-
 triazole 1 A639
 azidohydroxyphenylpropionic acid 1 A639
 azidohydroxytetrazole 1 A639; 9 T125
 azidoiminomethanediazonium hydroxide
 1 A639
 1-(azido-iminomethyl)-4-guanyl-1-tetrazene
 1 A639
 1-azido-2-iodoethane 1 A639
 azido-4-iodopicolinyl 1 A639
 azidoiodosobenzene 1 A639; 7 T123
 azidoiodoxybenzene 1 A639; 7 T123
 azidoiodoxybenzene 1 A639; 7 T121
 azidolactic acid 1 A639
 azidomethane 1 A639; 8 M66
 azidomesitylenes 8 M61–M62
 azidomethoxyacetophenone 1 A639
 azidomethoxytoluene 1 A639
 azidomethylaniline 1 A640
 azidomethylanisole 1 A640; 8 M104
 azidomethylbenzene 1 A640 see Toluene azides
 9 T301–T302
 azidomethylbutane see Amylazide 1 A395
 azidomethylbutanone 1 A640
 azidomethyl-dinitrobutylbenzene 1 A640
 azidomethylcarbamyl azide 1 A640
 azidomethylethylketone semicarbazide 1 A640
 azidomethylethyl ketoxime 1 A640
 azidomethylformate 1 A640
 azidomethylfuroyl 1 A640
 azidomethylisocyanate 1 A640
 1-azido-3-methylpentane 1 A640
 N-azidomethyl-N'-phenylurea 1 A640
 azidomethylurea 1 A640
 azidonaphthalene 1 A640; 8 N5
 azidonitroacetyl chloride 1 A56
 azidonitrobenzene 1 A640; 2 B42

Azides, organic (list) (cont'd)

2-azido-4-nitrobenzenesulfonic acid 1 A640;
 2 B62
 5-azido-6-nitrobenzofurazan-3-oxide 1 A640
 5-azido-6-nitrobenzofuroxan 1 A640; 2 B68
 2-azido-6-nitro-1,4-benzoquinone-4-trimethyl-
 imide 1 A640–A641
 1-azido-N-nitroformamidine 1 A641; 6
 F168–F169
 azidonitromesitylene 1 A641; 8 M61
 azidonitronaphthalene 1 A641; 8 N6
 azidonitrophenol 1 A641
 azidonitrotoluene 1 A641
 azidooxalic acid ethyl ester 1 A641
 azidooxamate 1 A641; 8 O35
 azidooxanilic acid 1 A641
 azidooxomethane diazonium hydroxide 1 A641
 azidopentane see Amylazide 1 A395
 azidophenol 1 A641; 8 P229
 azidophenylacetic acid 1 A641
 azidophenylacetyl azide see Aminoacetophenone
 1 A178
 5-azido-1-phenyl-5-azidobenzene
 see Phenyl tetrazole 8 P246
 5-azido-2-phenyl-1,3,5-oxadiazole 1 A641
 azidophenyl propionic acid 1 A641; 7
 H213–H214
 (1'-azidophthalazine-4',5')-5,1-tetrazole 1
 A641–A642
 azidopropane 1 A642
 azidopropanedicarbonic acid 1 A642
 azidopropane oxime 1 A642
 azidopropanol 1 A642
 azidopropanone see Acetone and derivs 1 A39
 3-azido-1-propane see Allylazide 1 A137
 azidopropionaldehyde 1 A642; 8 P478
 azidopropionic acid amide 1 A642
 azidopropionic acid, ethyl ester 1 A642
 azidopropionic acid, methyl ester 1 A642
 azidopropionitrile 1 A642
 azidopropionylazide 1 A642; 8 P478
 azidopropylamine see Aminopropane 1 A250
 azidopropylene glycol dinitrate 1 A642; 8 P493
 1-[azido-iso-propylidene]-semicarbazide 1 A642
 azidopropylurea 1 A642
 1'-azidopseudocumene 1 A642
 azido-2,5-pyrazinedicarbonyl 1 A642
 azidoquinazolinetetrazole 1 A642
 azidosalicylic acid 1 A642
 see Hydroxybenzoic acid azide 7 H236

Azides, organic (list) (cont'd)

- azido-iso-succinic acid **1** A642; **9** S225
 azido-iso-succinic acid diamide **1** A642
 azido-iso-succinic acid, diethylester **1** A642
 azidosuccinic acid, diethylester **1** A642
 azidosuccinic acid, dihydrazide **1** A642
 azidosuccinyldiazide **1** A642; **9** S225
 azidotetramethylazobenzene **1** A642, A662
 azidotetrazole **1** A642; **9** T124—T125
 ω -azidotoluene **1** A642—A643; **2** B94
 azidotoluene **1** A643; **9** T301—T302
 azidotriazole **1** A643; **9** T362—T363
 2-azido-3,5,6-trichloro-1,4-benzoquinone
1 A643
 azido-2,4,6-trinitrobenzene **1** A643; **2** B43
 azido-iso-valeric acid **1** A643
 azido-iso-valeric acid amide **1** A643
 azido-iso-valeric acid ethyl ester **1** A643
 azido-iso-valeryl azide **1** A643
 azidoxylene **1** A643 see Azidodimethylbenzene
5 D1321
- β -azidoaminoethane **1** A199
- Azido and azides of benzoic acid and derivs
2 B69—B71
- Azido and azido halogen derivs of benzoquinone
2 B80—B81
- Azido and diazo derivs of dichlorobenzene **5**
 D1206—D1207
- Azidobenzaldehyde **2** B35
- 2-Azidobenzaldehyde-(4-nitrophenylhydrazone).
2 B37
- Azidobenzaldehydeoxime **2** B36
- Azido-benzaldehydephenylhydrazones **2** B37
- 2-Azidobenzamide **2** B39
- Azidobenzenes and azidonitrobenzenes **2**
 B42—B44; **9** T352
- Azidobenzenesulfonic acid **2** B62
- 5-Azidobenzoic acid-3-diazoniumhydroxide **2** B76
- Azidobenzophenone **2** B77
- 4-(4-Azidobenzylideneamino)-phenol **2** B97
- N-[(α -azidobenzylidene)-N'-benzylidene]-azine
2 B35—B36
- Azidobiphenyl **2** B123
- Azidobromobenzene **2** B308
- 1-Azido-2-bromoethane **2** B311
- Azidobutane **2** B367
- Azidobromotoluene **2** B316
- Azidobutanone **2** B374
- 1-Azidobutanone-2-oxime **2** B375
- 2-Azido-5-(tert-butyl)-4,6-dinitro-m-xylene **2** B390
- Azidobutyramide **2** B390—B391
- Azidobutyric acid **2** B391
- 4-Azido-butyronitrile **2** B393
- 4-Azidobutyryl hydrazide **2** B391—B392
- 8-Azidocaffeine **2** C3
- 3-Azido-d-camphor **3** C22—C23
- 3-Azidocarbazole **2** C47
- 5-Azido-3-carboxyphenyloxamic acid **2** C66
- Azidochloroethane **3** C254
- 1-Azido-3-chloropropane **3** C264
- 2-Azido-3-coumaranone **3** C548
- α -Azidocumene **3** C573
- Azidocyanoacetamide **3** C583
- Azido derivs of diethylaniline **5** D1226
- 1-Azido-2,3-(or m)-dibromobenzene **5** D1191
- 2-Azido-4,6-dibromophenol **5** D1194
- 1-Azidodiethylether **5** D1235
- Azidodimethylbenzene **5** D1321
- 2-Azido-3,5-dimethylbenzaldehyde **5** D1320
- 2-Azido-3,5-dimethylbenzoic acid **5** D1326
- 4 (or 6) -Azido-5,7-dimethylindazole **5** D1347
- Azidonitrobiphenyl **2** B123
- Azidodinitrodimethylbenzene **5** D1324
- 2-Azido-4,6-dinitro-1,3-dimethyl-5-tert-butyl-
 benzene **5** D1331
- Azidodiphenylmethane **5** D1464
- 4-Azidodiphenylnitrosoamine **5** D1427

- 5-Azido-1,4-diphenyl-1,2,3-triazole
5 D1485–D1486
- Azido-halogen-benzenes 2 B44
- Azidonitrile 2 B76–B77
- 6-Azido-5-nitro-benzofuroxan 2 B68
- Azidonitrobiphenyl 2 B123
- Azidonitrobromobenzene 2 B308–B309
- Azidonitrodimethylbenzene 5 D1322
- 5-Azido-3-nitrosamino-1,2,4-triazole 5 D1149
- 2-Azido-6-nitro-4-trimethylammonium-1,4-
benzoquinone 2 B84
- Azimid 1 A643
- Azimido 1 A643
- Azimidobenzene 1 A643
- Azimido-, azinitroso-, oxazimido-, oxazinitroso-
and nitroso-azimido compds 1 A643
- 5,6-Azimino-benzimidazole 1 A643
- 5,6-Azimino-benzimidazolone 2 B65
- 3,3'-Aziminobis [4-methyl] furazan 1 A643–A644
- Azine 1 A644
- Azinepurine 1 A644
- Azino 1 A644
- Azione dirompente o azione frantumante (Ital)
1 A644
- Azobenzaldehyde 1 A646
- Azocompds 1 A644–A645
chemical reactions 1 A645
definitions 1 A644–A645
prepn 1 A645
- Azocompds listing 1 A646–A662
azo-aminotetrazole see 3,6-Bis (2H-tetrazolyl-
5-)-sym-tetrazine 2 B158
azoaniline 1 A646
azoanisole and derivs 1 A646
azobenzene and derivs 1 A646–A650
azobenzenediazonium derivs 1 A650
azobenzenecarboxylic acids and derivs 1 A650
azobenzoic acids and derivs 1 A650–A651
azobis-(p-aminobiphenyl) 1 A651
azobis-(ethylenenitroso)-nitrate 1 A651
- Azocompds listing (cont'd)
azobisformic acid and derivs 1 A651–A652
azobisformamidine 1 A652
azobis (nitroformamidine) 1 A652
 α,α' -azobis-(chloroformamidine) 1 A652–A653
azobis (ethylformamide) 1 A653
azobis (methylformamide) 1 A653
azobis-(isobutyronitrile) 1 A653–A654
3,3'-azobis-(4-methyl) furazan 1 A654
5,5'-azobis-(3-propyl)-sym-triazole 1 A654
azodicarboxyhydrazide 1 A655
azoethane 1 A655
3,3'-azoindazole 1 A655
azomethane 1 A655
azomethines 1 A655
azonaphthalene and derivs 1 A655–A656
azophenetole and derivs 1 A656–A657
azophenol and derivs 1 A657–A658
azopiperidine 1 A658
azo propane 1 A658
2,2'-azopyridine 1 A659
azostilbene and derivs 1 A659
azotetrazole 1 A659–A660; 9 T126–T127
azotoluene and derivs 1 A660–A661
3,3'-azo (1,2,4-triazole) 1 A661–A662
azoxylenes and derivs 1 A662
- Azoles 1 A662
- Azon guided missile 1 A662
- Azot (Rus) 1 A662
Azotate (Fr) 1 A663
- Azotate (ou nitrate) d'ammoniaque (Fr) 1 A663
- Azotate (ou nitrate) de plomb (Fr) 1 A663
- Azotate (ou nitrate) de potasse (Fr) 1 A663
- Azotate (ou nitrate) de soude (Fr) 1 A663
- Azote (Fr) 1 A663
- Azote Powder Co 1 A663
- Azohydrates (Fr) 1 A663
- Azothydrique (acide) (Fr) 1 A663
- Azotidrato (o azotidruro) d'argento (Ital) 1 A663
- Azotidrato (o azotidruro) di piombo (Ital) 1 A663
- Azotine 1 A663
- Azotique (acids) (Fr) 1 A663
- Azotometer 1 A663

Azotures (Fr) 1 A663

Azoxy compds 1 A664–A665

definition 1 A664

nomenclature 1 A664

prepn 1 A664

reactions 1 A664

Azoxy compds listing 1 A665–A673

azoxyaniline and derivs 1 A665

azoxyanisole and derivs 1 A665–A666

azoxybenzaldehyde and derivs 1 A666

azoxybenzene and derivs 1 A666–A668

azoxybenzenecarboxylic acid and derivs

1 A668

Azoxy compds listing (cont'd)

azoxybenzenedicarboxylic acid and derivs
1 A668

azoxydicarboxylamide dioxime and derivs
1 A669–A670

azoxymethane and derivs 1 A670

azoxynaphthalene and derivs 1 A670

azoxyphenetole and derivs 1 A670–A671

azoxyphenol and derivs 1 A671

azoxypropane and derivs 1 A671–A672

azoxytoluene and derivs 1 A672–A673

azoxyxylene and derivs 1 A673

B

- B (explosif) 2 B1
- BA see Bromoacetone 2 B307
- B (poudre) 2 B1–B2
 comps; B (Am) 2 B1, BC 2 B1, BCNL 2 B1,
 BD 2 B1, BF 2 B1, BFNL 2 B1, BFP 2 B1,
 BFP₁ 2 B1, BG 2 B1, BGC 2 B1, BM 2 B1–B2,
 BN 2 B2, BN³ 2 B2, BN3F 2 B2, BNLM 2 B2,
 BRU 2 B2, BS 2 B2, BW 2 B2
 definition and history 2 B1
 manufg procedure 2 B2
- B (value) see Brisance or shattering effect
 2 B265–B300
- B₄ 2 B2
- B4 or type 2 expls 2 B2
- B77 2 B2
- BA-107 2 B2
- Bachmann, Werner E. 2 B2
- Backblast 2 B2
- Backbreak 2 B2
- Backflash 2 B2–B3
- Bacon, Roger 2 B3
- Bacteria and mold action on nitric esters and on
 smokeless proplnts 2 B3–B4
- Bacteriological or biological warfare see Chemical
 and bacteriological warfare 2 C171; Chemical,
 biological and radiological (CBA) warfare 2
 C171–C172
- Badische aniline-und sodafabrik (BASF) 2 B4
- Baelinites 2 B4
- Bagasse 2 B4
- Bagasse pith 2 B4
- Bags for propelling charges see Cartridge bags
 2 C77
- Baka bomb 2 B4
- Baked powder 2 B4
- Bakelite 2 B4
- Bakewell & Hurst 2 B4–B5
- Bakufun 2 B5
- Bakuhatsu-sei (Jap) 2 B5
- Balanced dope see Dope 5 D1532C
- Bolistita (Span) 2 B5
- Balistine (Fr & Ital) 2 B5
- Ball drop test 1 A573
- Balle (Fr) 2 B89
- Balle de fusil (Fr) 2 B5
- Balle perforante (Fr) 2 B5
- Balle traceuse (Fr) 2 B5
- Ballista 2 B5
- Ballistic cap 2 B5
- Ballistic homogeneity of Poudres B 2 B5
- Ballistic measuring methods and ballistic tests
 2 B5–B6
- Ballistic missile 2 B6
- Ballistic modifiers for cast rocket proplnts 2 B6
- Ballistic mortar test 1 VII; 2 B6
- Ballistic pendulum test 1 VII–VIII; 2 B6
- Ballistic pendulum chronographs 2 B6–B7
- Ballistics 2 B7–B8
 exterior ballistics 2 B7
 interior ballistics 2 B7; 7 I114
 terminal ballistics 9 T63–T68
- Ballistite 2 B8–B10
 different comps as used by various nations
 2 B8–B9
 modifications in manufacture 2 B8
 original compn and prepn method 2 B8
- Ballistograph 2 B10
- Balloons and airships and their application in war
 2 B10–B11
 definition 2 B10
 development of various balloon types 2 B10
 uses in war 2 B10–B11
- Balloon barrage 2 B11
- Ball lightning expln 4 D143

- Ball powder or ball grain powder 2 B11–B16
 ball powder manufacture,
 advantages 2 B15
 blending, packing and magazing 2 B14–B15
 deterrent coating 2 B13–B14
 disadvantages 2 B15–B16
 dry screening 2 B14
 filtering and centrifuging 2 B14
 glazing 2 B14
 history 2 B11
 lab prepn 2 B15
 shaping of proplnt 2 B11–B12
 wet screening 2 B13
- BAL n 2 B16
- Balsa wood nitrated 2 B16
- BAm (poudre) (Fr) 2 B16
- Bamboocellulose nitrate 2 B16
- Banana oil 1 A393
- Bangalore grenade 2 B16
- Bangalore torpedoes 2 B16)B18; 5 D1113
 demolition snakes 2 B17–B18; 5 D1113
 detonating cable 2 B17
- Baratol 2 B18–B19
 analytical procedure (PA) 2 B19
 cold mixed (80/20) 2 B18
 history & uses 2 B18
 poured 2 B18–B19
 prepn 67/33 2 B19
- Barbarit 2 B19
- Barbe 2 B19
- Barbette 2 B19
- Barbituric acid 2 B19
- BARC 1 A393; 2 B19
- Barisutaito 2 B19
- Barium 2 B20
- Barium acetylde 1 A70
- Barium chlorate 2 C185–C187
- Barium chloride 3 C237
- Barium chlorite 3 C245
- Barium chromate 3 C276–C279
- Barium diazide 1 A523–A524
- Barium dichromate 2 B20; 3 C284
- Barium nitrate 2 B20–B21
- Barium nitrate mixts, analytical 1 A586
- Barium nitraminoguanidine see Aminoguanidine
 1 A212
- Barium peroxide 2 B21; 8 P187–P190
 barium peroxide analysis 8 P188–P189
 prepn 8 P187–P188
 properties 8 P188
 toxicity 8 P189
 uses 8 P189
 USA mil spec 8 P188–P189
- Barium picramate 1 A242
- Barium picrate 8 P279
- Barium stearate 2 B21; 9 S211
- Barium sulfate 2 B21; 9 S234
- Barium tetrazidocuprate 2 B21
- Barlow bomb 2 B21
- Barnwell & Rollason 2 B21
- Baronal 2 B21–B22
 Baronal analysis 2 B22
 Baronal prepn 2 B22
 Baronal properties 2 B22
- Barrel finishing 2 B22
- Barrel, gun 2 B22
- Barrel oscillation 2 B22
- Barrel, rocket 2 B22
- Barricades in expls and ammo installations
 2 B22–B23
- Barrier creams 2 B23
- Barrier materials 2 B23–B24
- Barrier tests and their comparison with shooting
 tests 4 D145
- Baryte (Dynamites) 2 B24
- Baryte (poudre) 2 B24
- BAS 2 B24
- Base see Acid and base 1 A87
- Base charge of a detonator see Nonmilitary detonator
 4 D738–D741, Military detonators 4 D806

- Base charge of a proplnt 2 B24
- Base cover or plate 2 B24
- Base of a projectile 2 B25
- Base plate 2 B25
- Base plug 2 B25
- Bases used in the manufacture of expls and proplnts 2 B25
- BASF see Badische aniline-und sodafabrik 2 B4
- Bashforth chronograph see Chronographs 3 C308
- Basic cupric azide 1 A533
- Basic lead acetate 1 A28
- Basic lead azide 1 A555
- Basic lead salts of various organic N contg compds 2 B25
- Basic lead styphnate 5 D1277–D1278
- Basic lead styphnate, mixts, analysis 1 A586–A587
- Basso esplosivo (Ital) 2 B25
- Bast 2 B25
- BAT 2 B25
- Batteries, electric, dry 2 B25
- Batteries, electric, storage see Accumulators 1 A12
- Bautzen (poudre) 2 B26
- Bautzener sicherheitspulver 2 B26
- Bavarit 2 B26
- Bayen's fulminating mixt 2 B26
- Bayon (poudre) 2 B26
- Bayonet 2 B26
- Bazooka 2 B26
- BBC 2 B26
- BBP or M7 (proplnt) 2 B26
- BBV 2 B26
- BC (poudre) see B (poudre) 2 B1
- BCNL (poudre) see B (poudre) 2 B1
- BCP powder 2 B26
- BD see Base detonating artillery fuzes 4 D913
- BD (poudre) see B (poudre) BD 2 B1
- BDI & BDT 2 B26
- Beaded powder 2 B26–B27
- Beam-rider guidance systems for missiles 2 B27
- Beano 2 B27
- Beating or pulping of NC see Prepn of NCs 2 C102
- Beattie-Bridgeman (deton) equation of state 4 D271
- Bebie, Jules 2 B27
- Becco Chemical Div, Food Machinery & Chemical Corp 2 B27
- Becker (deton) equation of state 4 D272
- Becker, Karl 2 B27
- Becker-Kistiakowsky-Wilson (deton) equation of state 4 D272
- Beehive demolition charge see Demolition expls 3 B27
- Beet pulp Dynamite 2 B27
- Behavior towards heat tests 1 VIII, IX, X, XVII, XXII, XXIII
- Beilstein, Friedrich K 2 B27
- BEJ 2 B27
- Belaya smés 2 B27
- Belgian AN gelatine Dynamites see Table 1 A368
- Belgian control tests for expls 2 B28
- Belgian control test for aptitude to expln after remaining in a humid atmosphere 2 B28
- power 2 B28
- sensitivity 2 B28
- Belgian expls, ammo, weapons, related items and plants manufacturing them 2 B28–B32
- Belgian companies manufacturing expls 2 B29
- Belgian expls listing 2 B29–B30
- Belgian expls, proplnts, ammo and related items 2 B30–B31
- Belgian industrial expls 2 B29
- Belgian plants currently manufacturing ammo, weapons and related items 2 B31
- Belgian weapons listing 2 B31–B32

- Bellenite 2 B32
- Bellford powder 2 B32
- Bellites 2 B32–B33
- Bellot, Nicolas 2 B33
- Bell powder 2 B33
- Bender expl 2 B33
- Benedict expls 2 B33
- Benedict-Webb-Rubin (deton) equation of state
4 D274
- Benedite 2 B33
- Beneke expls 2 B33
- Benet-mercier automatic rifle 2 B33
- Bengal fire powder 2 B33
- Bengaline 2 B33
- Benite see Black powder modifications
2 B173–B174
- Benet powder 2 B33
- Bent & Tallery expls 2 B33
- Bent barrel or around the corner gun 2 B34
- Bentonite (activated clay) 2 B34
- Benton's electro-ballistic pendulum 2 B34
- Benzalaminoguanidine-1,6-dinitro-2-(aminoguanil)-
biguanidine benzaldehyde 1 A215
- Benzalaminoguanidinium-1,6-dinitro-2-(amino-
guanyl)-biguanidine benzaldehyde 1 A215
- 1-Benzalmino-5-phenyl- α (or 1H) tetrazole 2 B34
- 5-Benzalmino-2-phenyl- β (or 2H) tetrazole 2 B34
- Benzaldehyde and derivs 2 B35
 azidobenzaldehyde 2 B35
 azobenzaldehyde 1 A646
 azoxybenzaldehyde and derivs 1 A666
 3-benzaldehyde-3-diazoniumchloride 2 B35
 dinitrobenzaldehyde 2 B35
 2,6-dinitrobenzaldehyde-4-diazoniumchloride
2 B35
 mononitrobenzaldehyde 2 B35
 nitrosobenzaldehyde 2 B35
 2,4,6-trinitrobenzaldehyde 2 B35
- Benzaldehydeazine and derivs 2 B35–B36
 N-[(α -azidobenzylidene)-N'-benzylidene]-
azine 2 B35–B36
 dinitrobenzaldehydeazines 2 B36
 mononitrobenzaldehydeazines 2 B36
 tetranitrobenzaldehydeazines 2 B36
- Benzaldehydeoxime and derivs 2 B36–B37
 azidobenzaldehydeoxime 2 B36
 β -benzaldehydeoxime-picrylether 2 B36–B37
 dinitrobenzaldehydeoximes 2 B36
 mononitrobenzaldehydeoximes 2 B36
 nitrobenzaldehydeoxime-4-diazoniumchlorides
2 B36
 2,4,6-trinitrobenzaldehydeoxime 2 B36
- Benzaldehydephenylhydrazone and derivs 2 B37
 azido-benzaldehydephenylhydrazones 2 B37
 benzaldehyde-(N-nitrosophenylhydrazone)
2 B37
 dinitrobenzaldehyde phenylhydrazones 2 B37
 mononitrobenzaldehyde phenylhydrazone
2 B37
 2,4,6-trinitrobenzaldehyde phenylhydrazone
2 B37
- Benzaldehyde-nitrophenyl-hydrazone and derivs
2 B37
 2-azidobenzaldehyde-(4-nitrophenylhydrazone)
2 B37
 dinitrobenzaldehyde-nitrophenylhydrazone
2 B37
 mononitrobenzaldehyde-nitrophenylhydrazone
2 B37
 2,4,6-trinitrobenzaldehyde-(4-nitrophenyl-
hydrazone) 2 B37
- Benzaldehyde-dinitrophenylhydrazone and derivs
2 B37–B38
 dinitrobenzaldehyde-(2,4-dinitrophenylhydra-
zones) 2 B37
 mononitrobenzaldehyde-(2,4-dinitrophenyl-
hydrazone) 2 B37
 2,4,6-trinitrobenzaldehyde-(2,4-dinitrophenyl-
hydrazone) 2 B37–B38
- Benzaldehyde-trinitrophenylhydrazone and derivs
2 B38
 2,6-dinitrobenzaldehyde-(2,4,6-trinitrophenyl-
hydrazone) 2 B38
 mononitrobenzaldehyde-(2,4,6-trinitrophenyl-
hydrazone) 2 B38

- Benzaldehydephenylhydrazone peroxides 2 B38**
 benzaldehyde-phenylbenzylhydrazone peroxide
 2 B38
 benzaldehyde-p-tolyl-hydrazone peroxide
 2 B38
 3-nitrobenzaldehyde-phenylhydrazone peroxide
 2 B38
- Benzaldehyde-semicarbazone and derivs 2 B38**
 dinitrobenzaldehyde-semicarbazones 2 B38
 mononitrobenzaldehyde-semicarbazones 2 B38
 2,4,6-trinitrobenzaldehyde-semicarbazones
 2 B38
- Benzamide and derivs 2 B38–B39**
 2-azidobenzamide 2 B39
 dinitrobenzamide 2 B39
 mononitrobenzamide 2 B39
 2,4,6-trinitrobenzamide 2 B39
- Benzamidine and derivs 2 B39**
 benzamidine picrate 2 B39
 dinitrobenzamidines 2 B39
 nitrobenzamidines 2 B39
 nitrobenzamidine picrates 2 B39
- Benzamidoanisole and derivs 2 B39–B40**
 benzamido-dinitroanisoles 2 B39
 benzamido-trinitroanisoles 2 B39
 mononitrobenzamido-anisoles 2 B39
 nitrobenzamido-dinitroanisoles 2 B39
 nitrobenzamido-nitroanisoles 2 B39
 nitrobenzamido-trinitroanisoles 2 B39–B40
- Benzamidophenol and derivs 2 B40**
 benzamidodinitrophenol 2 B40
 3,5-dinitro-4-(3'-nitrobenzamido)-phenol 2 B40
 mononitrobenzamido-phenol 2 B40
- Benzanilide and derivs 2 B40–B41**
 benzdinitroanilide 2 B40
 dinitrobenzanilide 2 B40
 dinitrobenzdinitroanilide 2 B40–B41
 dinitrobenznitroanilide 2 B40
 mononitrobenzanilide 2 B40
 nitrobenzdinitroanilides 2 B40
 nitrobenzonitroanilides 2 B40
 nitrosobenzanilides 2 B40
 trinitrobenzanilide 2 B40
- Benzanilide-diazonium derivs 2 B41**
 1-benzanilide-3-nitro-4-diazoniumchloride
 2 B41
- Benzene and derivs 2 B41–B52**
 azidobenzenes and azidonitrobenzenes
 2 B42–B44; 9 T352
 azido-halogen-benzenes 2 B44
 benzene, analytical procedures 2 B41–B42
 benzene, nitro derivs, analytical procedures
 2 B51–B52
 nitrobenzenes 2 B45–B52
 nitrosobenzenes and nitronitrosobenzenes
 2 B44–B45
 trinitrobenzene 2 B47–B50; 9 T375–T378
- Benzeneazoacetaldoxime 2 B52**
- Benzeneazoacetaldoxime picrylester 2 B52**
- Benzeneazo-carboxy-phenyl triazole and derivs
 2 B52–B53**
- Benzeneazomethane and derivs 2 B53**
 benzeneazotrinitromethane 2 B53
 3,5-dinitrobenzeneazotrinitromethane 2 B53
 p-nitrobenzeneazotrinitromethane 2 B53
- Benzeneazoaniline see Aminoazobenzene 1 A184**
- Benzeneazobenzene see Azobenzene 1 A646**
- Benzeneazodiphenylamine see Anilinoazobenzene
 1 A420**
- Benzeneazonaphthalene and derivs 2 B53**
 dinitrobenzeneazonaphthalene 2 B53
 mononitrobenzeneazonaphthalene 2 B53
 trinitrobenzeneazonaphthalene 2 B53
- Benzeneazonaphthol and derivs 2 B53–B54**
 mononitrobenzeneazonaphthol 2 B53–B54
 trinitrobenzeneazonaphthol 2 B54
- Benzeneazonitronaphthol and derivs 2 B54**
 dinitrobenzeneazonitronaphthol 2 B54
 mononitrobenzeneazonitronaphthol 2 B54
- Benzene diazo- and diazonium derivs 2 B54–B58**
 chemistry, definition and history 2 B54–B55
 benzene diazonium chloride 2 B55
 benzenediazonium hydroxide and derivs
 2 B55–B56
 benzenediazonium nitrate 2 B56
 benzenediazonium oxalate 2 B56
 benzenediazonium perchlorate and derivs
 2 B56–B57
 benzenediazonium picrate 2 B57
 benzenediazonium sulfate 2 B57

- Benzene diazo- and diazonium derivs (cont'd)
 benzenediazonium sulfocyanate 2 B57
 benzenediazonium sulfonic acid and derivs
 2 B57
 benzenediazonium tetrachloroiodide 2 B57
 benzenediazonium tribromide 2 B58
 benzenediazonium salt of trinitromethane
 2 B58
 2,4-dinitrobenzenediazonium nitrate 2 B56
- Benzenediazooxide and derivs 2 B58–B60
 dinitrobenzenediazooxide 2 B59–B60
 mononitrobenzenediazooxide 2 B58–B59
 2,3,6-trinitrobenzene-4-diazo-1-oxide 2 B60
- 3-[1-Benzene-4-dimethylamino)-azo]-s (1,2,4)-
 triazole-5-azido 2 B60 see Dimethylamino-
 benzeneazotriazole azide 5 D1307
- Benzenhexamethanol and derivs 2 B60
 benzenhexamethanol hexanitrate 2 B60
- Benzenesulfenamide and derivs 2 B60
 2,4-dinitrobenzenesulfenamide 2 B60
 mononitrobenzenesulfenamides 2 B60
- Benzenesulfenic acid and derivs 2 B60–B61
 benzenesulfenylchloride 2 B61
 2,4-dinitrobenzenesulfenylchloride 2 B61
 mononitrobenzenesulfenylchlorides 2 B61
- Benzenesulfonic acid and derivs 2 B61–B63
 azidobenzenesulfonic acid 2 B62
 m-benzenedisulfonyl diazide 2 B62
 benzenesulfonic acid azoacetylhydrazide
 2 B62
 benzenesulfonyl azide 2 B61–B62
 benzenesulfonyl peroxide 2 B62
 benzenesulfonyl sulfuric acid peroxide 2 B62
 benzenesulfonyl-2,5-tolylenediazoimide 2 B62
 benzenesulfonyl-p-xylylene-2,5-diazoimide
 2 B63
 dinitrobenzenesulfonic acid 2 B62
 mononitrobenzene sulfonic acid 2 B62
 2,4,6-trinitrobenzene sulfonic acid 2 B62
- Benzenethiol and derivs 2 B63
 2,4-dinitrobenzenethiol 2 B63
 mononitrobenzenethiol 2 B63
 2,4,6-trinitrobenzenethiol 2 B63
- Benzene triozone 2 B63
- Benzidine and derivs 2 B63–B64
 benzidine, alkylated (nitro derivs) 1 A129;
 2 B64
- Benzidine and derivs (cont'd)
 2,2'-dinitrobenzidine perchlorate 2 B64
 N,N'-dinitro-N,N'-dimethyl-3,5,3',5'-tetranitro-
 benzidine 2 B64
 N,N'-dinitro-N,N'-dipropyl-3,5,3',5'-tetranitro-
 benzidine 2 B64
 mononitrobenzidine 2 B64
 2,5,3'-trinitrobenzidine 2 B64
- Benzil and derivs 2 B64–B65
 dinitrobenzil 2 B64
 mononitrobenzil 2 B64
 2,4,2',4',6'-pentanitrobenzil 2 B65
 tetranitrobenzil 2 B64–B65
- Benzimidazole and derivs 2 B65
 benzimidazole-diaziido-copper salt 2 B65
 dinitrobenzimidazole 2 B65
- Benzimidazolone and derivs 2 B65–B66
 5,6-azimino-benzimidazolone 2 B65–B66
 benzimidazolone-guanylimide 2 B66
 benzimidazolone see Aminobenzimidazole
 1 A187
 5,6-dinitrobenzimidazolone 2 B65–B66
 mononitrobenzimidazolone 2 B65
 trinitrobenzimidazolone 2 B66
- Benzin, benzine, petroleum benzine or gasoline
 2 B66
- Benzite (Fr) 2 B66
- Benzocarbazole and derivs 2 B66
 dinitrobenzocarbazole 2 B66
 mononitrobenzocarbazole 2 B66
 nitrobenzocarbazole 2 B66
 pentanitrobenzocarbazole 2 B66
- Benzodiazoles see Aminoindazoles 1 A224
- Benzodioxan and derivs 2 B66–B67
 dinitrobenzodioxan 2 B67
 mononitrobenzodioxan 2 B66–B67
 5,6,7,8-tetranitrobenzo-1,4-dioxan 2 B67
 trinitrobenzodioxan 2 B67
- Benzofurazan and derivs 2 B67–B68
 mononitrobenzofurazan 2 B68
- Benzofuroxan and derivs 2 B68–B69
 6-Azido-5-nitrobenzofuroxan 2 B68
 dinitrobenzofuroxans 2 B68–B69
 mononitrobenzofuroxan 2 B68
- Benzohydroxamic acid and derivs 2 B69
 mononitrobenzohydroxamic acid 2 B69

- Benzohdryl
 azidodithiocarbonate 1 A633
- Benzoic acid and derivs 2 B69–B75
 azido- and azides of benzoic acid and derivs
 2 B69–B71
 nitro and other derivs of benzoic acid
 2 B71–B75
- Benzoic acid diazoniumhydroxide and derivs
 2 B75–B76
 anhydro-(benzoic acid-2-diazoniumhydroxide)
 2 B75
 anhydro-(3-nitrobenzoic acid-4-diazonium-
 hydroxide) 2 B76
 benzoic acid-2-diazonium-(4-nitrophenyl)-
 ether 2 B75
 benzoic acid-2-diazoniumthiophenylether
 2 B75
 salts and other derivs of benzoic acid-2-
 diazoniumhydroxide 2 B75
 salts and other derivs of benzoic acid-3-
 diazoniumhydroxide 2 B75–B76
 salts and other derivs of benzoic acid-4-
 diazonium hydroxide 2 B76
- Benzoic acid trioxonides 2 B76
- Benzonitrile and derivs 2 B76–B77
 azidonitrile 2 B76–B77
 benzonitrile-3-diazoniumhydroxide 2 B77
 dinitrobenzonitrile 2 B76–B77
 mononitrobenzonitrile 2 B77
- Benzophenone and derivs 2 B77–B78
 azidobenzophenone 2 B77
 benzophenonediazide 2 B77
 dinitrobenzophenone 2 B77
 mononitrobenzophenone 2 B77
 tetranitrobenzophenone 2 B78
- Benzophenoxazine and derivs 2 B78
 dinitrobenzophenoxazine 2 B78
 mononitrobenzophenoxazine 2 B78
 X,X,X,X-tetranitro-2,3-benzophenoxazine
 2 B78
- Benzophenyltriazole and derivs 2 B78–B79
 dinitrobenzophenyltriazole 2 B78
 mononitrobenzophenyltriazole 2 B78
 tetranitrobenzophenyltriazole 2 B79
 trinitrobenzophenyltriazole 2 B78–B79
- Benzophenyltriazole, dihydro, and derivs 2 B79
 dinitrodihydroxy-benzophenyltriazole 2 B79
 pentanitrodihydroxybenzophenyltriazole 2 B79
- Benzophenyltriazole, hydroxyl, and derivs 2 B79
 dinitrohydroxybenzophenyltriazole 2 B79
 mononitrohydroxybenzophenyltriazole 2 B79
 tetranitrohydroxybenzophenyltriazole 2 B79
 trinitrohydroxybenzophenyltriazole 2 B79
- Benzopyrazoles see Aminoindazoles 1 A224
- Benzopyrylium compds 2 B79
- Benzoquinone and derivs 2 B79–B83
 azido and azido halogen derivs of benzoquinone
 2 B80–B81
 benzoquinone-1,4-azine 2 B82–B83
 diazonium derivs of benzoquinone 2 B81–B82
- Benzoquinonedimine and derivs 2 B83
 benzoquinone-1,4-di(bromoimine) 2 B83
 benzoquinone-1,4-(chloroimine) 2 B83
 benzoquinone-1,4-di(methylimine) 2 B83
 2,3,5-trinitrobenzoquinone-1-imino-4(?)-
 trimethylimine 2 B83
- Benzoquinonedioxime and derivs 2 B83–B84
 benzoquinone-1,4-dioxime, oxidation product
 2 B84
 dioxime, polymers of the anhydride 2 B84
- Benzoquinoneimine and derivs 2 B84–B85
 2-azido-6-nitro-4-trimethylammonium-1,4-
 benzoquinone 2 B84
 benzoquinone-1-imino-4-diazonium salts
 2 B85
 benzoquinone-1,4-monochloroimine 2 B84
 benzoquinone-1,4-monocyanhydrin 2 B84
 2,6-diazido-4-trimethylammonium-1,4-benzo-
 quinone 2 B84–B85
 4,6-dinitro-1,2-benzoquinone-2-chlorimine
 2 B85
- Benzoquinone monooxime and derivs 2 B85–B86
 benzoquinone-1-(β -chloroethylimine)-4-oxime
 2 B85
 benzoquinone-1,4-monooxime hypochlorite
 2 B85
 benzoquinone-1-semicarbazone-4-oxime 2 B85
 3-bromo-1,4-benzoquinone-1-methylimine-4-
 oxime 2 B85–B86
 2,6-dibromo-1,4-benzoquinone-4-oxime 2 B86
 6-nitro-3-hydroxy-1,2-benzoquinone-2-
 oxime-4-diazonium hydroxide 2 B86
 6-nitro-4-nitrosamino-3-hydroxy-1,2-benzo-
 quinone-2-oxime 2 B86
 4-nitro-6-nitrosoamino-5-hydroxy-1,2-benzo-
 quinone-2-oxime 2 B86

- Benzotoluide and derivs 2 B86
 mono-, di and tri-nitrobenzotoluides 2 B86
 tetranitrobenzotoluide 2 B86
- Benzotriazine and derivs 2 B86–B87
 (benzo-1,2,3-triazine)-3-oxide 2 B86
 (benzo-1,2,3-triazine)-4-oxide 2 B86–B87
 1,2,3-benzotriazino-(3-4-a) perimidine see
 o-Amidophenylperimidine 2 A246
 6-nitrobenzo-4-oxy-victriazine 2 B87
- Benzotriazole and derivs 2 B87
 dinitrobenzotriazole 2 B87
 mononitrobenzotriazole 2 B87
- Benzotriazolol and derivs 2 B87–B89
 (5,7-dichlorobenzo-6-nitro)-benzotriazol-1-ol
 2 B88
 5,6-dichlorobenzo-triazol-1-ol 2 B88
 5- and 6-monochloro-benzotriazol-1-ol
 2 B87–B88
 (6-mononitro-5-acetic acid)-benzotriazol-1-ol
 2 B88
 4- and 6-mononitro-benzotriazol-4-ol 2 B88
 6-mononitro-benzotriazol-4-ol 2 B88–B89
- Benzotrifluoride and derivs 2 B89
 dinitrobenzotrifluoride 2 B89
 mononitrobenzotrifluoride 2 B89
- Benzoylacetateperoxide see 1 A55
- Benzoylacylperoxide see Acetylbenzoylperoxide
 1 A54
- Benzoylaminoglyoxime 2 B89
- Benzoyl azidodithiocarbonate see 1 A633
- Benzoylazidomethane see Acetophenone, azido
 derivs 1 A47
- Benzoylchloride and derivs 2 B89–B90
 dinitrobenzoylchloride 2 B89–B90
 mononitrobenzoylchlorides 2 B89
 2,4,6-trinitrobenzoylchloride 2 B90
- 4-[(N-Benzoyl-N-ethyl)-amino]-naphthalene-1-
 diazonium hydroxide 2 B90
- Benzoyl nitrate and derivs 2 B90
 3-nitrobenzoyl nitrate 2 B90
- Benzoyl nitrite 2 B90
- Benzoylperchlorate 2 B90
- Benzoylperoxymonosulfonic acid 2 B90
- (1-Benzoyl-IV-tetrazolyl-5)-isotetrazene
 2 B90–B91
- Benzone see Acetylbenzoylperoxide 1 A54
- Benzyl abietate 1 A3
- Benzylacetyl peroxide see Acetylbenzylperoxide
 1 A55
- Benzyl alcohol and derivs 2 B91–B92
 benzyl nitrate 2 B91
 benzyl nitrite 2 B91
 dinitrobenzyl alcohol 2 B91
 dinitrobenzyl nitrate 2 B92
 mononitrobenzyl alcohol 2 B91
 mononitrosobenzyl alcohol 2 B91
 nitrobenzyl dinitrate 2 B91–B92
 nitrobenzyl nitrate 2 B91
 trinitrobenzyl alcohol 2 B92
 2,4,6-trinitrobenzyl nitrate 2 B92
- Benzylamine and derivs 2 B92–B93
 benzylamine chlorate 2 C187
 benzylamine nitrate 2 B93
 benzylamine perchlorate 2 B93
 benzylamine picrate 2 B93
 benzylnitramine 2 B93
 dinitrobenzylamine 2 B93
 mononitrobenzylamine 2 B93
 nitrobenzylnitramine 2 B93
- 1-Benzyl-5-amino-vic-tetrazole see 5-Amino-1-
 benzyl-vic-tetrazole 1 A191
- Benzylaniline and derivs 2 B93–B94
 dinitrobenzylaniline 2 B93
 hexanitrobenzylaniline 2 B94
 mononitrobenzylaniline 2 B93
 pentanitrobenzylaniline 2 B94
 tetranitrobenzylaniline 2 B93–B94
 trinitrobenzylaniline 2 B93
 2',4',6'-trinitrobenzyl-2,4,6-trinitro-nitraniline
 2 B94
- Benzylazide and derivs 2 B94–B95
 dinitrobenzylazide 2 B94–B95
 mononitrobenzylazide 2 B94
- Benzylazidodithiocarbonate 1 A633
- Benzylbenzoate and derivs 2 B95
 benzyl mononitrobenzoate 2 B95
 dinitrobenzyl benzoate 2 B95
 benzoate 2 B95
 mononitrobenzyl mononitrobenzoate 2 B95

- Benzyl chloride and derivs 2 B95
 mononitrobenzyl chloride 2 B95
 trinitrobenzyl chloride 2 B95
- Benzyl cyanide and derivs 2 B95–B96
 dinitrobenzyl cyanide 2 B96
 mononitrobenzyl cyanide 2 B96
- Benzyl dimethylhexadecylammonium chloride
 2 B96
- 4-Benzyl-3,5-dioxo-4-pyrazolidineacetyl azide
 2 B96
- Benzyl diphenylamine 2 B96
- Benzylester of peracetic acid see Acetylbenzyl-
 peroxide 1 A55
- Benzylethylamine chlorate 2 C187
- Benzylethylene-oxonide 2 B96
- 1-Benzylideneamino-5-amino- α (or 1H)-tetrazole
 2 B96
- 1-Benzylideneamino-5-anilino- α (or 1H)-tetrazole
 2 B97
- Benzylideneaminophenol and derivs 2 B97
 4-(4-azidobenzylideneamino)-phenol 2 B97
 dinitrobenzylideneaminophenol 2 B97
 mononitrobenzylideneaminophenol 2 B97
 4-(2,4,6-trinitrobenzylideneamino)-phenol
 2 B97
- Benzylideneaniline and derivs 2 B97–B98
 dinitrobenzylidene aniline 2 B97
 mononitrobenzylideneaniline 2 B97
 tetranitrobenzylideneaniline 2 B98
 trinitrobenzylideneaniline 2 B97
- 2-Benzylidene-thio-carbazoyl azide 2 B98
- Benzylmalonic acid and derivs 2 B98
 benzylmalondiazide 2 B98
 mononitrobenzylmalonic acid 2 B98
 p-nitrobenzylmalonazidic acid 2 B98
- Benzylmethylamine chlorate 2 C187
- Benzylloxamic acid and derivs 2 B98–B99
 benzylloxaminy azide 2 B98–B99
- Benzylperacetate see Acetylbenzylperoxide 1 A55
- Benzyl perchlorate 2 B99
- Benzylphenyl ether and derivs 2 B99
 benzyl-dinitrophenyl ether 2 B99
- Benzylphenyl ether and derivs (cont'd)
 benzylmononitrophenyl ether 2 B99
 benzyl-2,4,6-trinitrophenyl ether 2 B99
 2,4-dinitrobenzyl-4-nitrophenyl ether 2 B99
 mononitrobenzyl-dinitrophenyl ether 2 B99
 mononitrobenzyl-mononitrobenzylphenyl
 ether 2 B99
 4-nitrobenzyl-2,4,6-trinitrophenyl ether 2 B99
 pentanitro derivs of benzylphenyl ether 2 B99
- Benzylpyridine and derivs 2 B99–B100
 dinitrobenzylpyridine 2 B100
 mononitrobenzylpyridine 2 B100
- Benzylsuccinic acid and derivs 2 B100
 benzylsuccinyl diazide 2 B100
- Benzyltoluidine and derivs 2 B100
 dinitrobenzyltoluidine 2 B100
 mononitrobenzyltoluidine 2 B100
 pentanitrobenzyltoluidine 2 B101
 tetranitrobenzyltoluidine 2 B101
 trinitrobenzyltoluidine 2 B101
- Benzyltriazole and derivs 2 B101
 1-4'-nitrobenzyl-3,5-dinitro-sym-triazole
 2 B101
- Berclavite B 2 B101
- Berdan rifle see Berdanka 2 B101
- Berdantsa (Berdan rifle) 2 B101
- Berg (expl) 2 B101
- Berge (expl) 2 B101
- Bergenstrom (expl) 2 B102
- Berger (expl) 2 B102
- Berger mixts 2 B102
- Berges, Corbin et Cie à Chedde 2 B102
- Bergmann, Emil 2 B102
- Bergmann expls 2 B102
- Bergmann-Junk test 1 VIII; 2 B102–B103
- Bergmann number 2 B103
- Bergmann's powder 2 B103
- Berg-Roburite expl 2 B103
- Berkhout stability test 2 B103
- Berl, Ernst 2 B103

- Berl & Kunze semimicro analytical detn of stability of NC 2 B103
- Berl pipette 2 B103–B104
- Berl saddles 2 B104
- Bernadou, John B. 2 B104
- Bernouilli, Daniel 2 B104
- Berta apparatus 2 B104
- Berthelot (deton) equation of state 4 D274
- Berthelot, Marcellin 2 B104–B105
- Berthelot's characteristic product 2 B105–B106
absolute temp of expln 2 B105
specific force 2 B105
- Berthelot powder 2 B106
- Berthelot theory of detonation 2 B106
transformation of calorific to chemical energy 2 B106
transformation of calorific to mechanical energy 2 B106
transformation of chemical to calorific energy 2 B106
transformation of mechanical to calorific energy 2 B106
- Berthold der Schwarze 2 B106
- Berthollet, Claude Louis 2 B106–B107
- Berthollet powder 2 B107
- Berthollet salt 2 B107
- Beryllium 2 B107
- Beryllium acylide 1 A70–A71
- Beryllium carbide 1 A71
- Beryllium diazide 1 A524–A525
- Beryllium sulfate 2 B107
- BESA machine gun 2 B107
- Beta cellulose 2 B107
- Beta and gamma-ray spectroscopy 2 B107
- Betaine 2 B107
- Betaine additive compds with acids forming expls 2 B107–B108
- Betaine expl derivs 2 B108
- Beta-ray autoradiography for the study of metals and minerals on microscale 2 B108
- Betatron 2 B108–B109
- Bettanin's expl 2 B109
- Betterman's electric delay detonator 2 B109
- Bevatron 2 B109
- Beyling, Carl 2 B109
- BF 2 B109
- BF-122 & BF-151 2 B109
- BFAM 2 B109
- BFNL 2 B109
- BFP 2 B109
- BFP (poudre) 2 B109–B110
- BG 2 B110
- BGC 2 B110
- BGY 2 B110
- BHQ 2 B110
- Biazzi, Mario 2 B110
- Bibenzyl and derivs 2 B110–B111
dinitrobenzyl 2 B110
2,4,6,2',4',6'-hexanitrobenzyl 2 B111
mononitrobenzyl 2 B110
nitrobenzyl 2 B111
2,4,6,2',4'-pentanitrobenzyl 2 B111
tetranitrobenzyl 2 B110
- BIC 2 B111
- Bicarbamyl azide 2 B111
- Bicarbite or bikarbit 2 B111
- Bichel, Christian E. 2 B111
- Bichel bomb (test) 1 VIII
- Bichel calorimetric bomb 2 B111
- Bichel expls 2 B112
- Bichel pressure gage test 1 VIII
- Bickford fuse or miner's safety fuse 2 B112
- Bickford igniter or igniter fuse 2 B112
- Bickford & Smith's primary mixture 2 B112

- Bicresol and derivs 2 B112–B113
 dinitrobicresol 2 B112
 mononitrobicresol 2 B112
 tetranitrobicresol 2 B112–B113
 trinitrobicresol 2 B112
- “Bicycle pistol” 2 B113
- BID 2 B113
- BIE 2 B113
- Bielefeld expl 2 B113
- Bielefeld’s gelatinization method 2 B113
- Bifuryl and derivs 2 B113
 5,5'-dinitro- α,α' -bifuryl 2 B113
- Big Bertha 2 B113–B114
- Biguanide and derivs 2 B114–B115
 biguanide, analytical procedures 2 B115
 biguanide complex compds with bivalent metals
 2 B114
 biguanide complex compds with tetravalent
 metals 2 B114
 biguanide complex compds with trivalent
 metals 2 B114
 biguanide nitrate 2 B114
 biguanide perchlorate and chlorate 2 B114
 biguanide picrate 2 B114
- Biguanidine and derivs 2 B115
 1,6-dinitrobiguanidine 2 B115
- Biimidazole and derivs 2 B115
 1,4' (or 1,5')-dinitrobiimidazole 2 B115
 1,5,1',5'-tetranitro-2,2'-biimidazole 2 B115
 1,5,4' (or 1,5,5')-trinitrobiimidazole 2 B115
- Biimidazoline and derivs 2 B115
 2,2'-bi(1-2 nitroso-2-imidazoline) 2 B115
- BIL and BIM 2 B116
- Binary, ternary and quarternary (expl) mixtures
 2 B116–B120
 Amatols 2 B116, B117
 Belgian compns 2 B117
 compn theory 2 B116
 French compns 2 B117
 German compns 2 B117
 history of compns 2 B116
 Italian compns 2 B117–B118
 Japanese compns 2 B118
 Russian compns 2 B118–B119
- Binary, ternary and quarternary (expl) mixtures
 (cont'd)
 Swedish compns 2 B119
 Swiss compns 2 B119
 US and Great Britain compns 2 B119
 uses 2 B116
- Binder or Agglutinant 2 B120–B121
- Binding energy see Atomic energy 1 A500
- Bindone 2 B121
- 2,2'-bi-(1-nitroso-2-imidazoline 2 B115
- Bio-oxidation 2 B121
- Bioxide d'hydrogene (Fr) 2 B121
- BIP 2 B121
- Biphenol and derivs 2 B122
 2,2'-diazo-3,3'-dioxy-4,6,4',6'-tetranitro-m,
 m'-biphenol 2 B122
 dinitrobiphenol 2 B122
 hexanitrobiphenol 2 B122
 pentanitrobiphenol 2 B122
 tetranitrobiphenol 2 B122
- Biphenyl-4-amine see Aminobiphenyls 1 A191
- Biphenyl and derivs 2 B122–B125
 azidobiphenyl 2 B123
 azidodinitrobiphenyl 2 B123
 azidonitrobiphenyl 2 B123
 biphenyl-4-amine see Aminobiphenyls 1 A191
 3,3'-dinitrobiphenyl-lead nitrate 2 B123
 2,4,6,2',4',6'-hexanitrobiphenyl salts 2 B123
 tetranitrobiphenyl 2 B124
 trinitrobiphenyl 2 B123–B124
- Biphenyl-bis (diazoniumhydroxide) and derivs
 2 B125
 2-nitrobiphenyl-bis-(4,4'-diazoniumhydroxide)
 2 B125
- Biphenylcarboxylic acid and derivs 2 B125
 dinitrobiphenylcarboxylic acid 2 B125
 monotrobiphenylcarboxylic acid 2 B125
 mononitrobiphenylcarboxylic acid 2 B125
 pentanitrobiphenylcarboxylic acid 2 B125
- Biphenyldiazomethane 2 B125
- Biphenyldiazonium hydroxide 2 B125
- Biphenyldiazonium perchlorate see 1 A191

- Biphenyldicarboxylic acid and derivs 2 B125–B126
 diazidobiphenyldicarboxylic acid 2 B125
 dinitrobiphenyldicarboxylic acid 2 B126
 hexanitrobiphenyldicarboxylic acid 2 B126
 mononitrobiphenyldicarboxylic acid
 2 B125–B126
 tetranitrobiphenyldicarboxylic acid 2 B126
- p,p'-Bi(phenylene-azo-trinitromethane) 2 B126
- Biphenyl tetraozonide 2 B126
- Biproplnt 2 B126
- Biproplnt rocket engine 2 B126
- Biresorcinol and derivs 2 B126–B127
 dinitrobiresorcinol 2 B127
 hexanitrobiresorcinol 2 B127
 tetranitrobiresorcinol 2 B127
- Birth (initiation) and growth of expln in solid and
 liquid expls initiated by impact, friction, etc
 2 B127
- Bis compds 2 B127–B128
 nomenclature 2 B122–B128
- Bis compds listing 2 B128–B161
 bis (allyloxymethyl)-propanediol and derivs
 2 B128
 bis (aminoethyl)-amine and derivs 2 B128–B129
 bis (aminoethyl)-ethanediurethane and derivs
 2 B129–B130
 bis (aminoethylamino)-propane and derivs
 2 B130
 bis (aminoguanidine)-1,6-dinitro-2-(amino-
 guanyl)-biguanidine 1 A214–A215
 bis (aminoguanidinium)-1,6-dinitrobiquanidine
 1 A214
 bis (aminomethyl)-propanediamine and derivs
 2 B130
 bis (anilino)-anthraquinone and derivs
 2 B130–B131
 bis (anilino)-azobenzene and derivs
 2 B131–B132
 bis (anilinophenyl)-urea and derivs 2 B132
 bis (anilino)-propane and derivs 2 B132–B133
 bis (5-aryl-2'-tetrazolyl)-formimine 2 B133
 bis (azidobenzylidene)-azine and derivs 2 B133
 3,4-bis [(azidoformyl) methyl] -hexanedioyl
 azide 2 B133
 bis-(azidothioformyl)-disulfide 2 B133
 bis (benzalamino-guanidine)-1,6-dinitro-
 guanidine 1 A215
- Bis compds listing (cont'd)
 bis (benzeneazo)-azobenzene and derivs 2 B134
 bis (benzeneazo)-azoxybenzene and derivs
 2 B134
 bis (benzoyl)-hydrazine and derivs
 2 B134–B135
 bis (benzoylperoxy)-cyclohexane and derivs
 2 B135
 bis (benzoylperoxy)-dicyclohexylperoxide and
 derivs 2 B135
 bis (benzoylperoxy)-dimethylhexane and derivs
 2 B135
 bis (benzoylperoxy)-fluorene and derivs
 2 B135–B136
 bis (benzylideneamino)-guanidine and derivs
 2 B136
 bis (biphenyl)-triazine and derivs 2 B136
 bis (biphenyl)-amine and derivs 2 B136
 bis (bromoanilino)-ethane and derivs
 2 B136–B137
 bis (bromoanilino)-propane and derivs 2 B137
 2,2-bis (t-butylperoxy)-butane 2 B137
 2,2-bis (t-butylperoxy)-propane 2 B137–B138
 bis (carboxamide)-acetylene 1 A65
 bis (carboxanilide)-acetylene 2 B138
 bis (chloroanilino)-ethane and derivs 2 B138
 bis (chloroanilino)-propane and derivs 2 B138
 bis (chloromethyl)-thallium chloride 2 B139
 1,1'-bis (o-chlorophenyl)-5,5'-azotetrazole
 2 B139
 1,4-bis (diazo)-butane 2 B139
 4,4'-bis (diazo)-3,3'-dioxybiphenyl 2 B139
 1,2-bis (diazo)-ethane 2 B139
 bis (diazo)-heptane 2 B139
 1,6-bis (diazo)-hexane 2 B139–B140
 1,5-bis (diazo)-pentane 2 B140
 bis (p-diazophenol)-dichromate 2 B140
 1,3-bis (diazo)-propane 2 B140
 bis (2-diazo-4-sulfenyl-N,S-oxy)-azobenzene
 2 B140
 bisdiazotetrazolyldiazide see [N',N⁶-Bis
 (a-tetrazolyl-5)]-hexazadiene 1 A260–A261
 1,2-bis [N-(4',6'-dibromo-2'-nitrophenyl)-
 nitramino]-ethane 2 B140
 1,3-bis [N-(4',6'-dibromo-2'-nitrophenyl)-
 nitramino]-propane 2 B140
 1,2-bis [N-(4',6'-dichloro-2'-nitrophenyl)-
 nitramino]-ethane 2 B140
 1,3-bis [N-(4',6'-dichloro-2'-nitrophenyl)-
 nitramino]-propane 2 B140
 bis (diethyl) lead styphnate, basic 2 B141

Bis compds listing (cont'd)

- bis (dihydroxypropyl)-oxamide and derivs
2 B141
- N,N'-bis (2,3-dihydroxypropyl)-oxamide
tetranitrate 2 B141
- 4,4'-bis-dimethylamino-benzophenon (Ger)
same as Auramine 1 A507
- bis (dimethylamino)-triphenylmethane and
derivs 2 B141
- bis (1,1-dimethyl-2-propynyl) peroxide 1 A66
- 1',2'-bis (2,2-dinitroalkyl)-amines 2 B141
- N,N'-[bis (2,2-dinitroalkyl)-hydrazines] 2 B141
- 1,3'-bis (1,3-dinitroxy-2-nitramino-propane)-
2',4',6'-trinitrobenzene 1 A252
- 1,3-bis (2,3-dinitroxy-1-nitramino-propane)-
2',4',6'-trinitrobenzene 1 A252
- bis-diphenylurea 2 B142
- bis-(ethylhexyl)-phthalate 2 B142
- bis (ethylnitrosamino)-azoxybenzene 2 B142
- 1,3-bis (ethyltriazol)-benzene 2 B142
- N,N'-bis (5-ethyl-s-triazol-3-yl)-formamidine
2 B142-B143
- 9,9'-bis (fluorenyl)-diperoxide 2 B143
- 3,6-bis (fluorenylidenehydro)-sym-tetrazine
2 B143
- bis (hexahydrobenzoyl)-peroxide 2 B143
- bishydrazicarbonyl see Note under 4-amino-
urazole 1 A272
- 3,6-bis (hydrazide)-1,2-dihydro-1,2,4,5-tetrazine
2 B143
- bis (hydrazine)-dinitrobenzene and derivs
2 B143-B144
- bis (hydroanthranol) and derivs 2 B144
- 1,1'-bis (hydroperoxycyclohexyl) peroxide
2 B144
- 2,5-bis (hydroperoxy-2,5-dimethyl)-hexane
2 B144
- 9,9'-bis (hydroperoxy) fluorane + 2 fluorenones
(adduct) 2 B145
- bis (α -hydroxybenzyl) peroxide 2 B145
- bis (1-hydroxycyclohexyl) peroxide 2 B145
- bis (hydroxyethoxy)-benzene and derivs 2
B145-B146
- bis (hydroxyethyl)-piperazine and derivs
2 B146
- bis (hydroxylamino) azide 1 A525
- bis (hydroxymethyl) methylaminomethane
2 A232
- bis (hydroxyphenyl)-anthranone and derivs
2 B147

Bis compds listing (cont'd)

- 2 [bis (p-hydroxyphenyl)] propane and derivs
see Aurine 1 A508
- bis (hydroxyphenyl) propane and derivs
2 B147-B148
- bis (hydroxyphenyl) sulfone and derivs 2 B148
- 5,5'-bis (1-hydroxytetrazole) 2 B148
- bis (α -hydroxy- β,β,β -trichloroethyl) peroxide
2 B148
- bis (methylamino) anthraquinone and derivs
2 B148-B149
- bis (methylamino) benzil and derivs 2 B149
- bis (methylamino) benzophenone and derivs
2 B149
- bis (methylamino) diphenylmethane and
derivs 2 B149
- bis (methylaminomethyl) methylamine and
derivs 2 B149-B150
- bis (methylamino) toluene and derivs 2 B150
- bis (1-methyl-1-ethyl-2-propynyl) peroxide
1 A66
- 1,3-bis (3-methyl-4-nitro-5-pyrazolyl) triazene
2 B150
- bis (methylphenylamino) ethane and derivs
2 B150-B151
- bis (methylphenylamino) propane and derivs
2 B151
- bis (1-methyl-1,2,3,4-tetrazolyl-5) diazene
2 B151
- N,N'-bis (5-methyl-s-triazol-3-yl) formamidine
2 B151
- bis (3-methyl-2,4,6-trinitrophenyl) amine
see 2,4,6,2',4',6'-hexanitro-3,3'-dimethyl-
diphenylamine 1 A443
- bis (naphthyl) succinamide and derivs 2 B151
- 1,2-bis (2-nitramino-2-imidazoline-1-yl)-ethane
see Aminoimidazoline and imidazoline
substituted derivs 1 A220
- 1,2-bis (2-nitramino-3-nitro-1-imidazolidyl)
ethane see Aminoimidazoline and imidazo-
line substituted derivs 1 A220
- 2,2-bis (3-nitro-5-methyl-4-hydroxyphenyl)
propane 2 B152
- N,N'-bis (2-nitroxyethyl) propylene dinitramine
5 D1246
- bis (nitroxymethyl)-methylaminomethane
see Aminomethylpropanediols 1 A252
- bis (penta-fluorosulfur) peroxide 2 B152
- N,N'-bis (phenylazo) cyclo-2,3,5,7-penta-
methylene-1,4-diamine 2 B152

Bis compds listing (cont'd)

- bis (phenylazo) dihydroxynaphthalene and derivs 2 B152–B153
 bis (phenylazo) glycine and derivs 2 B153
 bis (phenylazo) naphthol and derivs 2 B153
 bis (p-phenylbenzoyl)-furoxan 2 B153
 bis (phenyl) ethyleneglycol ether and derivs 2 B153–B154
 bis (phenyl) guanidine and derivs 2 B154
 bis [(phenyl-phenylamino)-ethyl]-aminoethane and derivs 2 B154–B155
 bis (phenylthio) dimethylbenzene and derivs 2 B155
 bis (phenylthio) ethylbenzene and derivs 2 B155
 bis (phenyl) urea and derivs 2 B155–B156
 bis (phthalic acid) peroxide 2 B156
 bis (styryl) benzene and derivs 2 B156
 bis (succinyl) peroxide 2 B156–B157
 5,5'-bis (α - or 1,2,3,4-) tetrazole 2 B157
 bis (5-tetrazole) hydrazine 2 B157
 3,6-bis (2H-tetrazolyl-5) dihydro-1,2,4,5-tetrazine 2 B157–B158
 bis [tetrazolyl-(S)] diimide see Azotetrazole 1 A659
 N', N⁶-bis (a-tetrazolyl-5)] hexadiene 1 A260
 3,6-bis (2H-tetrazolyl-5) sym (or 1,2,4,5) tetrazine 2 B158
 bis (tetrazolyl) triazene and derivs 2 B158
 N,N'-bis (thiocarbonyl) hydrazine 2 B158–B159
 5,5'-bis (p-tolyl) 1,1'-azotetrazole see Azo-5,5'-di (p-tolyl) tetrazole 1 A266
 bis [5-(p-tolyl) tetrazole-1] diazene see 1,1'-Azo, 5,5'-di (p-tolyl)-tetrazole 1 A266
 bis (1,3,5-triaza-3,5-dinitrocyclohexylmethyl) ether 2 B159
 bis (triazole) anthraquinone see Anthraquinone and derivs 1 A459
 bis (β' sym or β -1,2,4-) triazole 2 B159
 N,N'-bis (S-triazole-3-yl) formamidine 2 B159–B160
 bis (triazole) mesidine see 2-Amino-4,6-diazido mesitylene 1 A224–A225
 bis (triethyl) lead styphnate 2 B160
 bis (2,4,6-triisopropylbenzoyl)-furoxan 2 B160
 bis (2,4,6-trimethylbenzoyl)-furoxan 2 B160
 1,4-bis [N-(2',2',2'-trinitroethyl)-carboxamide] piperazine 2 B160
 bis (1,1,1-trinitroisobutyl) urea 2 B160
 N,N'-bis (2,2,2-trinitroethyl) urea 5 D1359

Bis compds listing (cont'd)

- N,N'-bis (1,1,1-trinitro-2-octyl) adipamide 2 B160–B161
 N,N'-bis (2,4-dinitrophenyl) oxamide 5 D1470
 N,N'-bis (3,5-dinitrophenyl) thiourea 5 D1484
 N,N'-bis (2,4-dinitrophenyl) 2,4,6-trinitro-1,3-phenylenediamine 5 D1472
 bis (2,2-dinitropropyl)-fumarete 5 D1498
 bis (diphenylcarbonyl) ethylenediamine 5 D1445
 3,3-bis (3-nitro-4-methylphenyl) phthalide 5 D1517
 N,N'-bis (4-nitrophenyl) acetamidine 5 D1414–D1415
 bis [3- (or 4-) nitrophenyl] furoxans 5 D1461
 3,5-bis (4-nitrophenyl) 1,2,4-triazole 5 D1486
 N,N'-bis (4-nitrosophenyl) piperazine 5 D1474
 1,3-bis (2,4,6-trinitrophenoxy) propane 5 D 1469
 N,N'-bis (2,4,6-trinitrophenyl) piperazine 5 D1475
 Bismuth 2 B161–B162
 Bismuth alloys 2 B162
 Bismuth azidodithiocarbonate 1 A636
 Bismuth compds 2 B162
 Bismuth triazide 1 A525
 Bisoflex 102 2 B162
 Bisulfate, sodium 2 B162–B163
 Bitartrate (acid tartrate) of potassium 2 B163
 Bithiophene and derivs 2 B163
 3,5,3',5'-tetranitro-2,2'-bithiophene 2 B163
 Bitolyl and derivs 2 B163
 dinitro-bitolyl 2 B163
 2,4,6,2',4',6'-hexanitro-3,3'-bitolyl 2 B163
 tetranitro-bitolyl 2 B163
 Bitumen 2 B164
 Bituminite 2 B164
 Biurea 2 B164
 Biuret and derivs 2 B164
 1,5-dinitrobiuret 2 B164
 1-nitrobiuret 2 B164
 Bixylyl and derivs 2 B164–B165
 dinitro-bixylyl 2 B165

- Bixylyl and derivs (cont'd)
 X,X,X,X-tetranitro-3,4,3',4'-(tetramethyl-
 biphenyl) 2 B165
- Bjorkmann expls 2 B165
- B-J test see Bergmann-Junk test 2 B102–B103
- BKI 2 B165
- BKZ 2 B165
- BL-1 3 C516
- BLA 2 B165
- Black diamond & black diamond Nu-Gel 2 B165
- Black Dynamite 2 B165
- Black liquor 2 B165
- Black match 2 B165
- Black powder or gunpowder 2 B165–B179
 black powder, analytical procedures
 2 B176–B177
 black powder destruction 2 B177–B178
 black powder fires 2 B178
 black powder, list of modifications
 2 B174–B176
 black powder modifications 2 B173–B174
 black powder packing, storage, handling,
 safety, precautions, maintenance, inspection,
 & surveillance, shipping & transportation
 2 B178–B179
 black powders contg potassium nitrate
 2 B168–B171
 black powders contg potassium nitrate used in
 European countries 2 B171–B172
 black powders contg potassium nitrate used in
 the USA 2 B171
 black powders contg sodium nitrate 2 B172
- Blainite 2 B179
- Blake expl 2 B179
- Blanche Dynamite 2 B179
- Blanche Dynamite de Paulilles 2 B179
- Blanch poudre (Fr) 2 B179
- Blank ammo 1 A383
- Blank cartridge 2 B179
- Blank cracker 2 B179–B180
- Blank powder 2 B180
- Blast 2 B18
- Blast effects in air, earth and water 1 VIII;
 2 B180–B184
 blast effects due to reflected shock waves
 2 B182
 blast effects in air 2 B180–B181
 blast effects in earth 2 B182–B183
 blast effects in water 2 B183–B184
- Blast contours 4 D148
- Blast furnace dust 2 B184
- Blast holes 2 B248
- Blastine 2 B184
- Blasting 2 B184–B185
- Blasting cap 2 B185–B201
 blasting cap compns, addnl refs 2 B189–B201
 blasting caps, electric 2 B186–B189
 blasting caps, non-electric 2 B185–B186
- Blasting caps and detonators, initiating efficiency
 1 VIII, XVIII
- Blasting caps and detonators, test of see Esop's
 test for efficiency of detonators 1 XI; Grotta's
 test for detonators 1 XV; Initiating efficiency
 of initiating expls, blasting caps & detonators
 1 XVII
- Blasting caps, military 4 D806
- Blasting coal, apparatus for 1 A474
- Blasting devices see Active list of permissible expls
 and blasting devices 1 A101
- Blasting expls 2 B202–B211
 addnl refs 2 B203–B211
 for military demolition 2 B203
- Blasting expls, ammonium nitrate 1 A341
- Blasting gelatin see Table 1 A147; 2 B211–B212
- Blasting gelatin, antifume 1 A466
- Blasting machine 2 B212
- Blasting oil 2 B212
- Blasting powder "A" 2 B212
- Blasting powder "B" 2 B212
- Blasting soluble NC 2 B212
- Blasting squibs, electric 2 B212–B214

- Blastite 2 B214
 Blast meters 2 B214–B215
 Blast, spherical 4 B149
 BLB 2 B215
 BLC 2 B215
 Bleiazid (Ger & Swiss) 1 A545
 “Blend” 2 B215
 Blindage (Gr) 2 B215
 Blindé (Fr) 2 B215
 Blindicide 2 B215
 Bloc de plomb ou bloc de Trauzl(Fr)
 see CUP 1 IX–X
 Blockbusters 2 B215–B216
 Block expls 2 B216
 Blockholing 2 B216
 Blocking and block breaking 2 B216
 Blomen 2 B216
 Blood pressure lowering 2 B216
 Blow 2 B215
 Blowback 2 B216
 Blowcase see Acid egg 1 A88
 Blown-out or burned shots 2 B216
 Blowout of tracers 2 B217
 Blue cross ammo 2 B217
 Blue Grass Ordnance Depot 2 B217
 Blue steel stand-off bomb see Daisy cutter bomb
 3 D2
 Bluff-shaped bomb 2 B217
 Bluff-shaped munitions 2 B217
 Bluff-shaped projectiles 2 B217
 Blunderbuss 2 B217
 BM mixture 2 B217
 BM powder 2 B217–B218
 BN see Bergmann number 2 B103
 BN powder 2 B218
 BNF powder 2 B218
 BN propellents 2 B218
 Boattail 2 B218
 Bobbinite 2 B218
 Boboeuf poudre 2 B218
 Bodewig, Jacob 2 B218
 Body of projectile 2 B218
 Bofors detonating cord or bonocord 2 B218
 Bofors Industries 2 B218–B219
 Bofors plant expln (Sweden) 2 B219
 Bofors plastic expl (BPE) 2 B219–B220
 Bofors propellents 2 B220
 Boghead Dynamite 2 B220
 Boilers, steam and steam power 2 B220
 Boiling and condensation temps, detn of 2 B220
 Boiling point vs latent heat of vaporization
 2 B220–B221
 Bolivian arms & ammo 2 B221
 Bollé, Erwin 2 B221
 Bolometer 2 B221
 Bolovon O 2 B221
 Bolton, F. (Sir) 2 B221
 Bolton powder 2 B221
 Boltzmann, L. 2 B221–B222
 Boltzmann’s constant 2 B222; 4 D149
 Boltzmann (detonation) equation of state 4 D274
 Boltzmann’s Law 2 B222
 Bomarc 2 B222
 Bomb adapter-boosters 4 D1010
 Bomb, American (initiating), device for 2 B222
 Bombard (Ital) 2 B222
 Bombard (verb) 2 B222
 Bombardelle 2 B222
 Bombardment 2 B222
 Bombardment flares 2 B222

- Bomb arming-delay mechanism 4 D1021
- Bomb armin-vane assemblies 4 D1020
- Bomb arming-wire assemblies 4 D1019
- Bomb auxiliary boosters 4 D1012
- Bomb blast 2 B222
- Bomb, British (initiating device for) 2 B222–B223
- Bomb bursters 4 D1014
- Bombcannon of Krupp 2 B223
- Bomb carpet 2 B223
- Bomb clusters and adapters, aimable fragmentation 4 D961
- Bomb clusters and adapters, gas 4 D964
- Bomb clusters and adapters, quick opening fragmentation 4 D961
- Bomb clusters and cluster adapters (definition) 4 D959
- Bomb clusters, incendiary 4 D962
- Bomb complete round 2 B223
- Bomb delay elements 4 D1014
- Bomb drag plates and spoiler rings 4 D1021
- Bomb drop tests 1 VIII
- Bomb expl train components 4 D1010–D1023
- Bomb flight stabilizers 4 D1021
- Bomb functioning test 1 VIII
- Bomb fuzes, hydrostatic 4 D998
- Bomb fuzes, inert 4 D1008
- Bomb fuzes (introduction) 4 D967
- Bomb fuzes, nonstandardized 4 D1000
- Bomb fuzes, pyrot 4 D1005
- Bomb fuzes used during WWII, foreign 4 D1008
- Bomb high expl trains 2 B223–B224
 - American bomb high expl trains 2 B223–B224
 - British HE bomb trains 2 B224
 - German HE bomb trains 2 B224
 - Japanese HE bomb trains 2 B224
- Bomb igniters 4 D1016
- Bomb initiators 4 D1023
- Bomb manometric 2 B224
- Bomb nonexpl components (other than clusters) 4 D1019
- Bomb, plastic 2 B225
- Bomb primer-detonators 4 D1013
- Bomb signal and spotting components 4 D1017
- Bomb signal cartridges 4 D1017
- Bomb spotting charge igniters 4 D1019
- Bomb spotting charges 4 D1019
- Bomb tail fuzes 4 D967
- Bombs 1 A384 see Bombs 2 B225–B238
 - bombs, chemical 2 B229
 - bombs, destruction 2 B233–B234
 - bombs, disposal of 2 B234
 - bombs, dropped from aircraft 2 B226–B227
 - bombs, dummy 2 B229–B230
 - bombs, fillers, addnl refs 2 B232–B233
 - bombs, HE 2 B227–B228
 - bombs, historical 2 B225
 - bombs, incendiary, extinguishing of 2 B234–B237
 - bombs, leaflet 2 B229
 - bombs, other classifications 2 B230–B232
 - bombs, packing, storage, handling, safety precautions, maintenance, inspection, surveillance, shipping and transportation of 2 B237–B238
 - bombs, practice and practice target 2 B229
 - bombs, pyrot 2 B229
- Bombs and bomb components 4 D933–D1023
- Bombs, aircraft depth (ADB) 4 D950
- Bombs, fire 4 D944
- Bombs, fragmentation 4 D933
- Bombs, gas (nonpersistent and persistent) 4 D949
- Bombs, general purpose (GP) 4 D935
- Bombs, incendiary 4 D941
- Bombs, leaflet 4 D951
- Bombs, listing of 2 B238–B241
 - bombs, aircraft depth charge 2 B238
 - bombs, AN-M-69 1 A457
 - bombs, antipersonnel 2 B238
 - bombs, antisubmarine 2 B238

Bombs, listing of (cont'd)

- bombs, antitank 2 B238
 - bombs, atomic 1 A999; 2 B238
 - bombs, blast 2 B238
 - bombs, British 2 B239
 - bombs, "buzz" 2 B239
 - bombs, chemical agent 2 B239
 - bombs, cobalt 2 B239
 - bombs, conventional 2 B239
 - bombs, delayed action 2 B239
 - bombs, Dynamite 2 B239
 - bombs, earthquake 2 B239
 - bombs, fission 1 A499; 2 B240
 - bombs, fusion 1 A499; 2 B240
 - bombs, guided 2 B240
 - bombs, heavy case 2 B240
 - bombs, high capacity 2 B240
 - bombs, hydrogen 1 A499
 - bombs, magnesium 2 B240
 - bombs, nuclear 1 A499
 - bombs, phosphorus 2 B240
 - bombs, robot 2 B241
 - bombs, rocket 2 B241
 - bombs, sabotage 2 B241
 - bombs, time 2 B241
 - bombs, torpedo 2 B241
 - bombs, uranium 2 B241
- Bombs, low-drag GP 4 D938
 - Bomb MT fuzes 4 D990
 - Bomb nose fuzes 4 D967
 - Bombs, practice 4 D959
 - Bomb proximity fuzes 4 D995
 - Bombs, pyrot (aircraft flares) 4 D953
 - Bombs, pyrot (aircraft signals) 4 D958
 - Bombs, pyrot (photoflash) 4 D951
 - Bombs, SAP (semi-armor piercing) 4 D933
 - Bombs, smoke 4 D948
 - Bomb tests 2 B225
 - Bomb, unexploded 2 B225
 - Bomlit 2 B241
 - Bond 2 B241
 - Bond energy 2 B241
 - "Bonderizing" 2 B241
 - Bonding 2 B241–B242
 - Bonding agents for ordnance 2 B242
 - Bonits 2 B241
 - Bonocord see Bofors detonating cord 2 B218
 - Booby trap 2 B242–B243
 - Books on expls, proplnts, pyrots and related items
1 A676; 2 C215–C216; 3 XIV–XV; 4 LI–LV;
5 XIV–XV; 6 X; 7 XI–XII; 8 XV; 9 XIII–XIV
 - Boom powder 2 B243
 - Booster 2 B243–B246
 - Boosters, description of 4 D876
 - Booster-gap expl sensitivity test of Cole & Edwards
4 D398
 - Booster rocket 2 B246–B247
 - Booster sensitivity (test) 1 VIII; 2 B247
 - Boracitol 2 B247
 - Boranes 2 B254–B256
 - Borates 2 B247
 - Borax 2 B247–B248
 - Borazole 2 B248
 - Bore 2 B248
 - Bore diameter 2 B248
 - Boreholes 2 B248
 - Bore resistance 2 B249
 - Boresafe 2 B249
 - Bore safe fuze 2 B249
 - Boric acid 2 B249
 - Borides 2 B249–B250
 - Boring, use of expls 2 B250
 - Boritines 2 B250
 - Borland powder 2 B250
 - Borland's method of manufacturing smokeless
powder 2 B250
 - Borlinetto powder 2 B250
 - Borneol 2 B250–B251

- Boron chloride pentahydride 2 B252
- Boron, its compds, expls, fuels and proplnts 2 B251–B257
- boron azide see Boron triazide 1 A525
 - boron carbide 1 A71
 - boron compds 2 B252–B253
 - boron, estimation of 2 B251–B252
 - boron expls 2 B253
 - boron hydrides 2 B253–B254
 - boron hydride fuels 2 B254–B256
 - boronites 2 B256–B257
 - boron solid proplnts 2 B257
- Borotorpex 2 B257
- Boroxazolidines 2 B257
- Bosch, Carl 2 B257
- Bostaph's expl 2 B257
- Bottelage des poudres (Fr) 2 B257
- Bottger, Rudolph 2 B257–B258
- Bottles 2 B258
- Bouche (Fr) 2 B258
- Bouche à feu (Fr) 2 B258
- Bouchon (Fr) 2 B258
- Bouchon detonant (Fr) 2 B258
- Boudineuse (Fr) 2 B258
- Boulengé (Le) Chronograph 2 B258
- "Bouncing Betty" mine 2 B258
- "Boundary" diameter 2 B258
- Bourrage (Fr) 2 B258
- Bourrelet (Fr) 2 B258
- Bow and arrow see Arrow 1 A488; Arbalest 1 A477; 2 B258
- Bowden, F.P. and Yoffe, A.D. 2 B258
- Bowen 2 B259
- Box ovens 2 B259
- Boyd powders 2 B 259
- Boy's apparatus 2 B259
- BP (pulver) 2 B259
- BPE see Bofors plastic expl 2 B219–B220
- BPY 2 B259
- BR 152 (polvere) (Ital) 2 B259
- Br 431 (polvere) (Ital) 2 B259
- Bracket's sporting powder 2 B259
- Braconnot, H. 2 B259–B260
- Brain powders 2 B260
- Brakes (weapons) 2 B260
- Brakes, muzzle 2 B260
- Brakes, recoil 2 B260
- Brame's stability test 2 B260
- Bram's powder 2 B260
- Bran 2 B260
- Brandeisl powder 2 B260
- Brander 2 B260
- Brandt mortars 2 B260–B261
- Brandt projectiles 2 B261
- Brank's powders 2 B261
- Brass 2 B261
- Brassage des poudres (Fr) 2 B261
- Brassey's annuals 2 B261
- Brazilian armament 2 B261–B262
- Brazilian expl plants 2 B261–B262
 - Brazilian weapons 2 B262
- Breaking theory of detonation 2 B262
- Breech 2 B262
- Breechblock 2 B262
- Breechloader 2 B262–B263
- Breech-loading 2 B263
- Breech-loading weapon 2 B263
- Breech mechanism 2 B263–B264
- Breech obturation 2 B269
- Breech piece 2 B264
- Breech screw 2 B264
- Breech sight 2 B264
- Bren machine gun 2 B264

- Bresin resin 2 B264
- Bridge wire 2 B264
- Brinkley-Wilson (detonation) equation of state 4 D274
- Brisance, correlation with chemical structure 4 D150
- Brisance, correlation with properties other than chemical 4 D150
- Brisance or shattering effect 2 B265–B295; 4 D149
 brisance, definition, formulae, and theory
 2 B265–B266
 brisance, refs 2 B295–B297
 brisance, tabulated test data of brisance and power
 derived from war expls 2 B266–B295
- Brisance, determination by method of metal acceleration by expl 4 D150
- Brisance-detonation velocity relationship
 2 B297–B299
- Brisance test methods 1 VIII–IX; 2 B299–B300
- Briska detonator 2 B300
- Britainite 2 B300
- British Ammonals 1 A289–A291
- British AN Dynamites 1 A368
- British commercial expls 2 B301
- British HE bomb trains 2 B224
- British hygroscopicity test for Black Powder 7 H251
- British military expls and proplnts, listing of
 2 B301–B302
 Abel's expl 1 A1
 Alumatol 1 A1
 Amatex 9 1 A157
 Amatols 1 A162
 Ammonals 2 B301
 Baratol 2 B18–B19, B301
 Black powder 2 B165–B179
 Burrowite 2 B362
 CE see Tetryl 9 T148–T164
 Composition A 3 C474–C477
 Composition B 3 C477–C484
 Cordite 3 C531–C541
 Cyclonite 3 C611–C630
 RDX 9 R120–R146
 Cyclotol 2 B301; 3 C474–C477
 DNB/RDX 2 B301
 DBX 2 B301
- British military expls and proplnts, listing of (cont'd)
 Guncotton expl 2 B301
 HMX see Cyclotetramethylenetetranitramine
 3 C605–C610; 8 P415–P416; 9 T83–T99
 Lead azide 1 A545–A587; 2 B301
 Lead styphnate 5 D1277–ff
 Lyddite 7 L63
 Mercuric fulminate 2 B301; 6 F217
 Minol II 8 M135–M143
 Nobel's 704 2 B301
 Nobel's 808 2 B301
 PE-2 3 C485; 8 P77–P78
 Penthrite 8 P86–P121
 Pentolite 8 P133–P136
 Picric acid 8 P285–P295
 Picric powder 1 A1; 8 P295–P296
 RDX 2 B301; 3 C611–C630; 9 R120–R146
 RDX/DNB–60/40 mixt 2 B301
 Shellite 2 B301; 9 S57
 Tetryl 9 T148–T164
 Tetrytol 2 B301; 9 T165–T166
 Torpex 2 B301; 9 T324–T329
 Trinitrotoluene see TNT 9 T235–T298
 Tritonol 9 T396–T399
 UWE 2 B302
- British tests 2 B302
- Britonites 2 B302
- Britonite 2 B302
- Brittle point 2 B302–B303
- BRL-1 2 B303
- Broberg and Wildrick 2 B303
- Brockite 2 B303
- Bromates 2 B303–B304
 bromates listed are: Al, ammonium, Ba, Cd, Ca,
 cupric, Pb, mercuric, mercurous, Ni, K, Ag, Na,
 St, Zn
- Bromides 2 B304
 bromides listed are: arsenic dibromide, dimethyl-
 arsinebromide, diphenylarsinebromide, chloro-
 phenylphenylarsinebromide, ethyl, methyl,
 methylarsinedibromide, phenylarsinedibromide;
 nitrosyl dibromide
- Brominated nitroparaffins 2 B304–B305
- Brominating agents, danger of expln 2 B305
- Bromination of phenols 2 B305

- Bromine 2 B305
- Bromine azide 1 A525–A526
- Bromine azidodithiocarbonate 1 A635
- Bromine chloride 2 B305
- Bromine fluorides 2 B305–B306
- Bromine hydrate 2 B306
- Bromine oxides 2 B306
- Bromoacetone 2 B307
- Bromoacetylene 2 B307
- Bromoaniline and derivs 2 B307
 dinitrobromoaniline 2 B307
 mononitrobromoaniline 2 B307
- Bromazobenzene and derivs 2 B307–B308
 dinitrobromoazobenzene 2 B308
 mononitrobromoazobenzene 2 B308
 trinitrobromoazobenzene 2 B308
- Bromoazoxybenzene and derivs 2 B308
 dinitrobromoazoxybenzene 2 B308
 mononitrobromoazoxybenzene 2 B308
 trinitrobromoazoxybenzene 2 B308
- Bromobenzene and derivs 2 B308–B309
 azidobromobenzene 2 B308
 azidonitrobromobenzene 2 B308–B309
 dinitrobromobenzene 2 B309
 mononitrobromobenzene 2 B309
 nitrosobromobenzene 2 B309
 4-nitroso-1,3-dinitro-5-bromobenzene 2 B309
 1-nitroso-4-nitro-2-bromobenzene 2 B309
 trinitrobromobenzene 2 B309
- Bromobenzohydroxytriazole and derivs
 2 B309–B310
 mononitrobromobenzohydroxytriazole 2 B310
- Bromobenzoquinone and derivs 2 B310
 2-bromo-1,4-benzoquinone-1-oxime 2 B310
 2-bromo-1,4-benzoquinone-4-oxime 2 B310
 2-bromo-1,4-benzoquinone-4-methylimine-1-oxime 2 B310
 2-diazo-3-bromo-o-benzoquinone 2 B310
 mononitrodiazobromobenzoquinone 2 B310
- 3-Bromo-1,4-benzoquinone-1-methylimine-4-oxime 2 B85–B86
- Bromobenzoyl azide and derivs 2 B310–B311
 dinitrobromobenzoyl azide 2 B311
- Bromobenzoylazidodithiocarbonate see
 Azidodithiocarbonic acid 1 A633
- Bromodiazotoluene sulfonic acids 5 D1180
- Bromoethane and derivs 2 B311
 1-azide-2-bromoethane 2 B11
 1,1-dinitro-1-bromoethane 2 B311
 1-nitro-1-bromoethane 2 B311
- Bromoethanol and derivs 2 B311–B312
 2-bromoethylnitrate 2 B311
 2-nitro-2-bromoethanol 2 B312
 2-nitro-2-bromoethylnitrate 2 B311–B312
- Bromoethyne see Bromoacetylene 2 B307
- Bromoform and derivs 2 B312
 nitrobromoform 2 B312
- Bromomethane and derivs 2 B312–B313
 dinitrobromomethane 2 B312
 mononitrobromomethane 2 B312
 trinitrobromomethane 2 B312–B313
- Bromomethylaniline and derivs 2 B313–B314
 dinitrobromomethylaniline 2 B313
 2,6-dinitro-N-nitroso-4-bromo-N-methylaniline
 2 B313–B314
 mononitrobromomethylaniline 2 B313
 mononitro-N-nitroso-bromomethylaniline 2 B313
 nitrosobromomethylaniline 2 B313
 tetranitrobromomethylaniline 2 B314
 trinitrobromomethylaniline 2 B314
- Bromonicotinic acid and derivs 2 B314
 5-bromo-nicotinyl azide 2 B314
- Bromophenol and derivs 2 B314–B315
 dinitrobromophenol 2 B315
 mononitrobromophenol 2 B315
 nitrosobromophenol 2 B315
 tetranitrobromophenol 2 B315
 trinitrobromophenol 2 B315
- Bromophenyltriazene 2 B315
- Bromoresorcinol and derivs 2 B315–B316
 dinitrobromoresorcinol 2 B316
 mononitrobromoresorcinol 2 B316
- 5-Bromo-1,2,3,4-tetrazole 2 B316
- Bromotoluene and derivs 2 B316–B317
 azidobromotoluene 2 B316
 dinitrobromotoluene 2 B316–B317
 trinitrobromotoluene 2 B317

- 3 (or 5)-Bromo-1,2,4-triazole 2 B317
- Bronnert and Schlumberger 2 B317
- Bronolithe 2 B317
- Bronstein's expls 2 B317
- Brookhaven National Lab 2 B317
- Brown charcoal 2 B317
- Browning, John Moses 2 B318
- Browning's weapons 2 B318
 - Browning aircraft cannon 2 B318
 - Browning automatic pistols 2 B318
 - Browning automatic rifles 2 B318
 - Browning machine gun 2 B318
 - Browning machine rifles 2 B318
- Brown's Dynamite 2 B318
- Brown's powder 2 B318
- Broyage (Fr) 2 B318
- Broyage de poudre noire (Fr) 2 B318
- Brugere powder 2 B318
- Brunswig, H. 2 B318–B319
- Brunswig's test 2 B319
- Brynk, A.F. 2 B319
- BSI sieves 2 B319
- BSP powder 2 B319
- BSQ 2 B319
- B-Stoff 2 B319
- BSX see Diacetoxy-2,4,6-trinitro-2,4,6-triazahexane 5 D1119
- BTM 2 B319
- BTZ 2 B319
- Bubbles of gas in expls 2 B320
- Bubbles of gas in liquid expls, suppression of bubble initiation 2 B320
- Buck's expl 2 B320
- Budenberg's expl 2 B320
- Buechert 2 B320
- Buhrle, Emil George 2 B320
- Building and other structures at ordnance establishments 2 B320–B321
- Built-up guns 2 B321–B322
- Bulk and condensed powders 2 B322–B323
- Bulk compressibility and bulk modulus 2 IX
see Bulk modulus and bulk compressibility 2 B323–B324
- Bulldog brand powder 2 B324
- Bulldog missile 2 B324
- Bulldog, special 2 B324
- Bullet impact sensitiveness test 1 IX; 2 B332–B334
- Bullets 2 B324–B331
 - bullets, historical 2 B324–B327
 - bullets, lead 2 B327
 - bullets, metal jacketed 2 B327–B331
- Bullets, blank and dummy 2 B331
- Bullets, dumddum 2 B331
- Bullets, frangible 2 B331–B332
- Bullet splash 2 B332
- Bullets, spotter-tracer 2 B332
- Bullet tests 2 B332–B340
 - bullet fit (jumps) test for caliber .45 ammo 2 B332
 - bullet impact test 2 B332–B334
 - bullet penetration test 2 B334
 - bullet pull test 2 B334
 - bullet stripping test 2 B334
 - bullet tests Refs (annotated) 2 B334, B340
 - bullet tracer test 2 B334
- Bull goose or goose 2 B340
- Bullpup missile 2 B340–B341
- Bullseye powder 2 B341
- Bullseye modified 2 B341
- Bumblebee 2 B341
- BuMines 2 B341
- Bumper 2 B341
- Bumper missile 2 B341
- Bumper valve 2 B341
- Bu-NENA 2 B341

- Bunsen, Robert W. 2 B341
- BuOrd 2 B341
- Buramine 2 B341–B342
- Bureau of Aeronautics 2 B342
- Bureau of Expls 2 B342
- Bureau of Naval Weapons 2 B342
- Bureau of Ordnance 2 B342
- Bureau of Standards 2 B342–B343
- Burn cuts 2 B343
- Burned shots 2 B343
- Burner 2 B343
- Burner plate 2 B343
- Burning and combustion 2 B343
- Burning area, required 2 B343
- Burning and burning characteristics of expls,
including experimental procedures
2 B343–B346
- Burning and burning characteristics of proplnts
for artillery weapons and small arms 2 B346–B349
burning rate of proplnts 2 B347–B348
burning velocity index of proplnts 2 B348
Piombert's law 2 B346–B347
theory of burning of proplnts 2 B348
- Burning and burning characteristics of proplnts,
exptl procedures 2 B349–B350
- Burning and burning characteristics of proplnts
for rockets 2 B350–B355
biproplnts syst 2 B351
composite syst 2 B351
double-base systs 2 B350, B351–B352
hypergolic syst 2 B351
liquid syst 2 B350, B351
monoproplnts syst 2 B351
nonhypergolic syst 2 B351
resonance burning 2 B352
solid proplnts 2 B352
stoichiometric ratio 2 B351
- Burning and burning characteristics of pyrots
2 B355–B356
- Burning and deflagration of gases, vapors and dusts
4 D154
- Burning characteristics and thermal decomposition
products of some synthetic cellular materials
2 B356–B357
- Burning, erosive (in proplnts) 2 B357
- Burning fuse 2 B357
- Burning ground 2 B357–B358
- Burning, neutral 2 B358
- Burning of ammo and expls for destruction
2 B358–B359
- Burning of Black Powder; inhibition by foreign
substances 2 B359
- Burning of various substances 2 B359
- Burning-out of Lydolite and other shells 2 B359
- Burning, physical law of (in interior ballistics)
2 B359
- Burning, progressive 2 B359
- Burning, propagative 4 D163
- Burning rate 2 B359
- Burning rate coefficient 2 B359
- Burning rate linear 2 B359–B360
- Burning rates of condensed expls 4 D163
- Burning rates of expl mixtures with air or gases,
vapors and dusts 4 D164
- Burning rate of proplnts 2 B347–B348
- Burning rates of proplnts; exptl techniques 4 D165
- Burning rates of proplnts for rockets 4 D165
- Burning rates of proplnts for artillery weapons
4 D164
- Burning rates of pyrot compns 4 D165
- Burning rates of safety fuses 2 B360
- Burning rate tests 1 IX
- Burning, regressive (or digressive) 2 B360
- Burning shots 2 B360
- Burning tests 1 IX
- Burning time 2 B360
- Burning time and equivalent heat of exothermic
mixtures 2 B360

- Burning time of a rocket (or Jato) motor
 2 B360–B361
 "Hercules" 2 B361
 50-percent 2 B361
 10-percent 2 B361
 total 2 B361
 Burning train 2 B361–B362
 Burning, unstable (in rocket motors)
 2 B361–B362
 Burning velocity index of proplnts 2 B348
 Burnout 2 B362
 Burnout time 2 B362
 Burnt 2 B362
 Burn tests, capability to 1 IX
 Burnt velocity 2 B362
 Burp gun 2 B362
 Burrowite 2 B362
 Burrow's expl of 1914 2 B362
 Burrows & Hoyt expl 2 B362
 Burrow's inventions 2 B362–B363
 Burst 2 B363–B364
 Burst center 2 B364
 Burst diaphragm 2 B364
 Bursterberger expls 2 B364
 Burster 2 B364
 Bursting charge 2 B364
 Bursting layer 2 B364
 Bursting point of NC 2 B364–B365
 Bursting screens 2 B365
 Burst pressure 2 B365
 Burst range 2 B365
 Burst wave 2 B365
 Burton, J. 2 B365
 Burton's expl 2 B365
 Buse's expl 2 B365
 Bush 2 B365
 Business end of a blasting cap 2 B365
 Butadiene and derivs 2 B365–B366
 butadiene nitrosite 2 B366
 butadiene ozonide polymer 2 B366
 butadiene ozonides 2 B366
 butadiene peroxide polymer 2 B366
 mononitrobutadiene 2 B366
 n-Butane and derivs 2 B366–B368
 azidobutane 2 B367
 1-diazobutane 2 B367
 dinitrobutane 2 B367
 hexanitrobutane 2 B368
 mononitrobutane 2 B367
 2,2,3,3-tetranitrobutane 2 B367–B368
 1,1,1-trinitrobutane 2 B367
 iso-Butane and derivs 2 B368
 dinitro-iso-butane 2 B368
 mononitro-iso-butane 2 B368
 Butanediol and derivs 2 B368–B370
 butanediol dinitrate 2 B369
 butanediol dinitrite 2 B369
 2,3-butanediol-3-nitrate 2 B369
 1,4-dinitro-2,3-butanediol 2 B369–B370
 1,1,1,4,4,4-hexanitro-2,3-methoxybutanediol
 2 B370
 1,1,4,4-tetranitro-2,3-butanediol 2 B370
 1,4-Butanedicarboxylic acid see Adipic acid
 1 A104
 iso-Butanediol and derivs 2 B370
 nitro-iso-butanediol dinitrate 2 B370
 Butanetriol and derivs 2 B370–B371
 butanetriol dinitrate 2 B370–B371
 butanetriol trinitrate 2 B371
 Butanol and derivs 2 B372–B374
 butanol nitrate 2 B373
 butanol nitrite 2 B373
 dinitrobutanol 2 B374
 mononitrobutanol 2 B373–B374
 nitrobutanol nitrate 2 B373
 nitrobutanol nitrite 2 B373
 1,1,1-trinitrobutanol 2 B374
 1-Butanol-2-amine see 2-Amino-1-butanol 1 A192
 Butanolaniline see Anilinobutanol 1 A422

- Butanone and derivs 2 B374–B375
 azidobutanone 2 B374
 3-diazobutane-2-one 2 B374
 mononitrobutanone 2 B375
- Butanoneoxime and derivs 2 B375
 1-azidobutanone-2-oxime 2 B375
 p-toluenesulfonylbutanoneoxime 2 B375
- Butanone peroxide derivs 2 B375
- Butene and derivs 2 B375–B376
 dinitrobutene 2 B376
 mononitrobutene 2 B375
 trinitrobutene 2 B376
- Butene polymer Dynamite 2 B376
- Butenyl 2 B376
- Butine 2 B376
- Butterov, Alexander M. 2 B376
- Butt target 2 B376
- iso-Butyl acetyl ricinoleate 2 B376–B377
- Butylamine and derivs 2 B377
 butylnitramine 2 B377
- 1-Butylaminobenzene-4-diazonium hydroxide
 2 B377
- C-Butyl-aminotoluene and derivs 2 B377
 dinitro-C-butylaminotoluene 2 B377
 nitro-C-butyl-aminotoluene 2 B377
 trinitro-C-butylaminotoluene 2 B377
- N-Butyl-aminotoluene and derivs 2 B377–B378
 3,5-dinitro-4-N-butyl aminotoluene 2 B377
 3,5-dinitro-4-(N-butyl-N-nitro) aminotoluene
 2 B377–B378
 3,5-dinitro-4-(N-butyl-N-nitroso)aminotoluene
 2 B377
 2,3,5-trinitro-4-(N-butyl-N-nitro) aminotoluene
 2 B378
 2,3,5-trinitro-4-(N-butyl-N-nitroso) amino-
 toluene 2 B378
- Butylammonium tetrazidocuprate 2 B378
- C-Butyl-aniline and derivs 2 B378
 dinitro-C-butylaniline 2 B378
 mononitro-C-butylaniline 2 B378
- N-Butylaniline and derivs 2 B378–B379
 dinitro-N-butylaniline 2 B378–B379
 mononitro-N-butylaniline 2 B378
- N-Butylaniline and derivs (cont'd)
 N-nitroso-N-butylaniline 2 B378
 tetranitrobutylaniline 2 B379
 trinitro-N-butylaniline 2 B379
- Butylanisole and derivs 2 B380
 dinitrobutylanisole 2 B380
 trinitrobutylanisole 2 B380
- Butylbenzamide and derivs 2 B380
 mononitrobutylbenzamide 2 B380
 trinitrobutylbenzamide 2 B380
- Butylbenzene and derivs 2 B380–B381
 dinitrobutylbenzene 2 B380–B381
 mononitrobutylbenzene 2 B380
 trinitrobutylbenzene 2 B380
- Butylbutyramide, trinitro deriv 2 B381
- iso-Butylcarbanyl azide 2 B381
- Butylcarbinol see Amylcohols 1 A394
- Butyl "Cellosolve" 2 B381
- Butylcresol and derivs 2 B381–B382
 dinitrobutylcresol 2 B381
 nitrobutylcresol 2 B381
 trinitrobutylcresol 2 B381–B382
- Butylene glycol ethers 2 B382
- Butylene oxides 2 B382
- Butylene ozonides 2 B382–B383
- Butylethanolamine and derivs 2 B383
 butylethanolamine dinitrate 2 B383
 1-(N-butylnitramino)-2-nitroxy-ethane 2 B383
- Butylethyltoluene and derivs 2 B383
 3-(tert-butyl)-5-ethyltoluene, trinitro derivs
 2 B383
- Butylforoamide, trinitro deriv 2 B383
- Butylguanidine and derivs 2 B383–B384
 mononitrobutylguanidine 2 B384
 N-nitro-N-(n-butyl)-N'-nitroguanidine 2 B384
 N-nitroso-N-(n-butyl)-N'-nitroguanidine 2 B384
- Butylhydrindene and derivs 2 B384
 6,7-dinitro-5-(tert-butyl)-hydrindene 2 B384
 4,6,7-trinitro-5-(tert-butyl)-hydrindene 2 B384
- Butylhydroperoxides 2 B384–B385
 tert-butylhydroperoxide-p-nitrobenzoate
 2 B385

- Butylhydroperoxides (cont'd)
 tert-butylhydroperoxide, oxalic acid ester
 2 B385
 tert-butylhydroxymethylperoxide 2 B385
 2-Butyl-2-(hydroxymethyl)-1,3-propanediol
 2 B385
 iso-Butylmalonic acid and derivs 2 B385–B386
 iso-butylmalonic acid amide azide 2 B386
 iso-butylmalonic acid monoazide 2 B386
 iso-butylmalonic acid monohydrazide 2 B386
 iso-butylmalonic acid nitril azide 2 B386
 Butyl mercaptan 2 B386
 Butylmethylanisole and derivs 2 B386
 dinitrobutylmethylanisole 2 B386
 trinitrobutylmethylanisole 2 B386
 Butyl oxalate 2 B387
 Butyl peroxyacetate 2 B387
 tert-Butyl peroxybenzoate 2 B387–B388
 Butylphenol and derivs 2 B388
 dinitrobutylphenol 2 B388
 trinitrobutylphenol 2 B388
 Butyl ricinoleate 2 B388
 Butyl rubber 2 B388
 Butyltetryl 2 B379
 Butyltoluene and derivs 2 B388–B389
 dinitrobutyltoluene 2 B388–B389
 mononitrobutyltoluene 2 B388
 2,4,5,6-tetranitro-3-(tert-butyl)-toluene 2 B389
 trinitrobutyltoluene 2 B389
 n-Butyl-4,4,4-trinitrobutyrate 2 B389
 2-Butyl-(1,1,1-trinitro-n-propyl) ether 2 B389
 N-Butylurethane and derivs 2 B389
 mononitrobutylurethane 2 B389
 N-nitroso-N-(n-butyl)-urethane 2 B389
 Butylxylene and derivs 2 B390
 2-azido-5-(tert butyl)-4,6-dinitro-m-xylene
 2 B390
 dinitrobutylxylene 2 B390
 trinitrobutylxylene 2 B390
 3-Butyn-1-yl-p-toluenesulfonate 2 B390
 Butyramide and derivs 2 B390–B391
 azidobutyramide 2 B390–B391
 2-nitro-iso-butyramide 2 B391
 2-nitroso-iso-butyramide 2 B391
 trinitrobutyramide 2 B391
 Butyric acid and derivs 2 B391–B392
 azidobutyric acid 2 B391
 hydrazide 2 B391–B392
 butyric acid azide 2 B391
 butyric acid hydrazide 2 B391
 dinitrobutyric acid 2 B392
 mononitrobutyric acid 2 B392
 trinitrobutyric acid 2 B392
 trinitrobutyric acid derivs 2 B392
 Butyric anhydride 2 B392
 Butyrolactone- α -carbonyl azide 2 B392–B393
 Butyrone, dipropyl ketone 2 B393
 Butyronitrile and derivs 2 B393
 4-azido-butyronitrile 2 B393
 mononitrobutyronitrile 2 B393
 2-nitroso-iso-butyronitrile 2 B393
 trinitrobutyronitrile 2 B393
 Butyrophenone and derivs 2 B393–B394
 mononitrobutyrophenone 2 B393–B394
 mononitro-diazobutyrophenone 2 B394
 Butyrylhydroperoxide 2 B394
 Butyryl nitrate 2 B394
 Butyryl nitrite 2 B394
 BUU 2 B394
 Buxton test 2 B394
 Buzylene 2 B394
 BV-143 2 B394
 BV-246 2 B394
 BWC 2 B394

C1**C**

- C (expls) (Fr) 2 C1
C (expls) see Compn C, C-2, C-3 and C-4
3 C474–C477
C (powder) 2 C1
C, (poudre) 2 C1
C-2 2 C1
C₂ (expl) 2 C1
C-2 (polvere) (Ital) 2 C1
C₂ (poudre) 2 C1
C6 2 C1
C-44 2 C1
C/68 2 C1
C/75 2 C1
C/77 2 C1
C/88 2 C1
C/89 2 C1
C-509 2 C1
CA₁ 2 C1
CA₂ 2 C1
Cacodyl cyanide 2 C1–C2
CAD 2 C2
CAD's 2 C70–C71
Cadaverine 2 C2
3,3-dinitrocadaverine 2 C2
Cadmium 2 C2
Calcium acetate 1 A28
Cadmium acetylde 1 A71
Cadmium amide 1 A69; 2 C2
Cadmium azidodithiocarbonate 1 A636
Cadmium chlorate 2 C187
Cadmium chloride 3 C237–C238
Cadmium diammine azide 1 A277
Cadmium diazide 1 A527
Cadmium hexammine bromate 1 A277
Cadmium hexammine chlorate 1 A277
Cadmium hexammine perchlorate 1 A277
Cadmium hydrazine nitrate 2 C2
Cadmium tetrammine bromate 1 A277
Cadmium tetrammine chlorate 1 A277
Cadmium tetrammine iodate 1 A277
Caffeine and derivs 2 C3
8-azidocaffeine 2 C3
8-nitrocaffeine 2 C3
Cahücit 2 C3
Cake 2 C3
Caking (or agglomeration and its prevention)
2 C3–C5
Calcimit 2 C5
Calcium 2 C5
Calcium acetate 1 A28
Calcium acetylde 1 A71–A72
Calcium chlorate 2 C187
Calcium chloride 2 C238
Calcium chlorite 2 C245
Calcium chromate 3 C279
Calcium diazide dihydrazinate 1 A528
Calcium diazide monohydrazinate 1 A527
Calcium dichromate 3 C284
Caldirola & Paterson (detonation) equation of
state 4 D274
Caliber 2 C5–C6
Calibers and uses of artillery ammo and rockets
(USA) 1 A386–A387 see Caliber 2 C5–C6
Calibers and uses of small arms ammo (USA)
1 A386 see Caliber 2 C5–C6
Calibration of chemical glassware at plants
manufacturing expls, etc 2 C6
Calibration of hydrometers 2 C6
Calibration of lab thermometers 2 C6

- Calibration of TNT thermometers 2 C6–C8
- Calibration of weights and analytical balances 2 C8
- Caliche or nitre-bed 2 C8
- Caliver see Arquebus 1 A488; 2 C8
- Callenburg's Dynamite 1 C8
- Callendar (detonation) equation of state 4 D274
- Cal-nitro 2 C8
- Calorie or calory 2 C8
- Calorific constant of expls or proplnts 2 C8–C9
- Calorific values of expls 2 C9
- Calorific values, calorimetric values and calorimetric potentials of NC and proplnts 2 C9–C10
- Calorimeter, calorimetry and calorimetric detns 2 C10–C12
- Calorimetric measurements in combustion, deflagration, explosion and detonation 4 D166
- Calorimetric tests for expls 1 IX
 Calorimeter, calorimetry and calorimetric determinations 2 C10–C12
 Thermochemistry 9 T190–T203
- Calorite 2 C12
- Camberites 2 C13
- Cameras, high-speed photographic 2 C13–C19
 historical 2 C13
 modern 2 C13–C17
- Camouflet 2 C19
- Camphene and derivs 2 C19–C20
 camphenitronitrosite 2 C20
 camphenitrosite 2 C20
 campheneozonide 2 C20
 nitrocamphenes 2 C19–C20
 5-nitroso-5-nitrocamphene 2 C20
- Camphor and derivs 2 C21–C23
 3-azido-d-camphor 2 C22–C23
 camphor, analytical procedures 2 C21–C22
 diazocamphor 2 C23
 mononitrocamphor 2 C23
 iso-nitrosocamphor 2 C23
 pernitrosoisonitrosocamphor 2 C23
- Camphorated blasting gelatin 2 C23
- Camphoric acid and derivs 2 C23
 d-camphoric acid peracid 2 C23
- Camphor oil 2 C23–C24
- α -Camphylamine 2 C24
- Canada asbestos 2 C24
- Canada balsam 2 C24
- Candle, in pyrots 2 C24
- Candlepower 2 C24 see Flares and signals 8 P505–P506
- Candlepower of pyrots 2 C24 see Flares and signals 8 P505–P506
- Canister or case-shot 2 C24–C25
- Cannel coal 2 C25
- Cannel expls 2 C25
- Cannizzaro, Stanislao 2 C25–C26
- Cannon 2 C26–C29
 guided missile launcher 2 C29
 gun 2 C26–C27
 howitzer 2 C27
 mortar 2 C27–C28
 recoilless gun 2 C28
 rocket launcher 2 C28–C29
 trench mortar 2 C28
- Cannonites 2 C29
- Cannon proplnt or powder 2 C29–C39
 analytical procedures 2 C38–C39
 double-base 2 C33–C37
 foreign 2 C37–C38
 historical 2 C29–C31
 single-base 2 C31–C33
 triple-base 2 C37
- Canon (Fr) 2 C39
- Canon antiaérien (Fr) 2 C39
- Canon antichar (Fr) 2 C39
- Canon à tuyère (Fr) 2 C39
- Canon de campagne (Fr) 2 C39
- Canon de gros calibre (Fr) 2 C39
- Canon de place (Fr) 2 C39

- Canon de siege (Fr) 2 C39
 Canon lisse (Fr) 2 C39
 Canon obusier (Fr) 2 C39
 Canon san recul (Fr) 2 C39
 Canon torpille (Fr) 2 C39
 Canone (Span) 2 C39
 Canone sin retroceso 2 C39
 Canopus 2 C39
 Canouil powder 2 C39
 Capacity of bomb or projectiles 2 C39
 Cap of an AP shell 1 A483
 Capexco powder 2 C39
 Capped projectile 1 A483
 Caprylene and derivs 2 C39–C40
 X,X-dinitrocaprylene 2 C40
 X-mononitrocaprylene 2 C39–C40
 "Cap sensitive" expl 2 C40
 Carbamic acid and derivs 2 C40–C42
 carbamic acid esters 2 C40
 carbamic acid ethyl esters 2 C40–C41
 carbamic acid methyl ester 2 C41
 carbamic azide 2 C40
 N-chlorocarbamic acid methyl ester 2 C41–C42
 mononitrocarbamic acid 2 C40
 nitrocarbamic acid ethyl ester 2 C41
 nitrocarbamic acid methyl ester 2 C42
 nitrosocarbamic acid methyl ester 2 C42
 3-Carbamoyl-5-cyano-2-diazo-4,6-dinitrophenol
 2 C42
 3-Carbamyl-5-cyano-2-diazo-6-nitro-hydroquinone
 2 C42–C43
 [I (or N')-Carbamyl-III (or N)-quanyl]-triazene
 2 C43
 [I (or N')-Carbamyl-III (or N)-hydroxy-III (or N)-
 (p-aminophenyl)]-triazene 2 C43
 Carbanilic acid and derivs 2 C43–C44
 carbanilic acid azide 2 C43
 trinitrocarbanilic acid esters 2 C43–C44
 Carbanilide and derivs 2 C44
 dinitrocarbanilide 2 C44
 Carbanilide and derivs (cont'd)
 dinitrocarbanilide 2 C44
 hexanitrocarbanilide 2 C44
 mononitrocarbanilide 2 C44
 nitrocarbanilide 2 C44
 tetranitrocarbanilide 2 C44
 trinitrocarbanilide 2 C44
 Carbazid 1 A528
 Carbazide 2 C45
 Carbazole and derivs 2 C45–C50
 3-azidocarbazole 2 C47
 carbazole, analytical procedures 2 C45–C46
 carbazole-3-diazonium hydroxide 2 C47
 3-diazocarbazole 2 C47
 nitrated compds of carbazole 2 C47–C50
 Carbene 2 C50–C51
 Carbides, carbonides or carburets 2 C51
 Carbinamine 1 A225–A226
 Carbine 2 C51
 Carbite 2 C51
 "Carbitol" 2 C51
 "Carbitol" solvent 2 C51
 Carboazotine or Cahuecit 2 C51–C52
 N (or 4)-Carbobutoxy-morpholine 2 C52
 Carbdynamites 2 C52
 N-Carboethoxy-2-amino-1-butanol 2 C52
 N-Carboethoxy-1-amino-2-ethanol 2 A20
 N-Carboethoxy-2-amino-2-methyl-1-propanol
 2 C52
 N-Carboethoxy-1-amino-2-propanol 2 C52
 N-Carboethoxy-furfurine 2 C52–C53
 N (or 4)-Carboethoxy-morpholine 2 C53
 [I (or N')-Carboethoxyphenyl-III (or N)-carb-
 anilino] triazene 2 C53
 4-Carboethoxy-phenyltriazene 2 C53
 Carbogelatin 2 C53
 Carbohydrates 2 C53–C54
 Carbohydrazide 2 C54

- Carbohydrazide-N-carbamoyl 2 C54
- Carbohydrazide-N-carboxyamide 2 C54
- Carbohydrazide-N,N-dicarbamoyl 2 C54
- Carbohydrazide-N,N'-dicarboxyamide 2 C54
- Carbon 2 C54—C59
carbon analytical procedures 2 C57—C58
carbon dust explosibility and its uses in expl
2 C55
- Carbonaceous material 2 C59
- Carbonates and bicarbonates 2 C59—C60
- Carbonation 2 C60
- Carbon carbonite 2 C60
- Carbon dioxide 2 C60
- Carbon disulfide and derivs 2 C60—C61
carbon disulfide monoazide 2 C61
see Azidodithiocarbonic acid 1 A632
- Carbonic acid 2 C61
azidothio derivs 1 A632
- Carbonites 2 C61—C62
- Carbonization 2 C62
- Carbonize 2 C62
- Carbon monoxide 2 C62
- Carbon tetrabromide 2 C63
- Carbon tetrachloride 2 C63—C64
- Carbon tetrafluoride 2 C64
- Carbon tetraiodide 2 C64
- o-Carbonylazido-diphenylurea 2 C64
- Carbonylazido-guanidine 2 C64
- (5'-Carbonylazido-pyridine)-1',2':4,5-tetrazole
2 C66
- Carbonyl diazide 1 A528; see Carbohydrazide
2 C54
- Carbonyls 2 C64
carbonyls include iron monacarbonyl, iron
pentacarbonyl, iron tetracarbonyl, nickel
carbonyl, potassium carbonyl, sodium carbonyl
- Carbonylurea 2 C64—C65
- Carborundum 2 C65
- Carboxyhydrocinnamic acid and derivs 2 C65
mononitrocarboxyhydrocinnamic acid 2 C65
3,4,6- (or 3,5,6)-trinitro-2-carboxyhydro-
cinnamic acid 2 C65
- Carboxymethylcellulose 2 C65
- [I (or N')-Carboxyphenyl-III (or N)-cyanoguanyl]-
triazene 2 C65—C66
- Carboxyphenyloxamic acid and derivs 2 C66
5-azide-3-carboxyphenyloxamic acid 2 C66
- (5'-Carboxypyrido)-1',2':4,5-tetrazole 2 C66
(5'-carbonylazidopyridine)-1',2':4,5-tetrazole
2 C66
- (3'-Carboxypyrido)-5',6':4,5-vic (or 1,2,3)-
triazole 2 C66
- Carboxytriazole and derivs 2 C66—C67.
4-carboxy- α -vic (or 1,2,3)-triazole 2 C67
5-nitrosamino-3-carboxy- α -sym-triazole ethyl
ester 2 C67
- Carburant (Fr) 2 C67
- Card-gap sensitivity test of Cook et al 4 D398
- Cardox 2 C67—C68
- Card test 4 D399
- Carga hueca (Span) 2 C68
- Carica a punta vuota (ital) 2 C68
- Carillon (expl) 2 C68
- Carlisle Lumber Co 2 C68
- Carlit or karitto 2 C68—C69
- Carlsonites 2 C69
- Carnotite 2 C69
- Carob-bean 2 C69
- Caro's acid 2 C69
- Car-prill 2 C69
- Carriages and mounts testings 2 C69
- Cariere (poudre de) 2 C69
- Carronade 2 C69—C70
- Carry-over effect 2 C70
- Cartouche (Fr) 2 C70
- Cartouche à balle (Fr) 2 C70

- Cartouche à blanc (Fr) 2 C70
- Cartouche complète (Fr) 2 C70
- Cartouche d'amorçage (Fr) 2 C70
- Cartouche d'exercice (Fr) 2 C70
- Cartouche sans douille (Fr) 2 C70
- Cartridges 2 C70
- Cartridges and cartridge-actuated devices (CAD's) 2 C70–C72
 - gas-generating 2 C71
 - historical 2 C70–C71
 - special purpose 2 C71–C72
 - stroking device 2 C71
- Cartridge, airdox 1 A117
- Cartridge, ammo 2 C73–C77
 - historical 2 C73
 - military, Argentina 1 A478
 - military, Belgium 2 B30 ff
 - military, Germany 2 C76
 - military, Italian 2 C76
 - military, NATO, smallarms 2 C76
 - military, US 2 C73–C76
- Cartridge bags 2 C77
- Cartridge, ball 2 C77
- Cartridge belt 2 C77
- Cartridge, blank 2 C77
- Cartridge, blasting 2 C77–C78
- Cartridge, canister 2 C78
- Cartridge cases 2 C78–C80
- Cartridge cases, tests of 2 C80
- Cartridge, clip 2 C80
- Cartridge, combustible 2 C80
- Cartridge counts 2 C80
- Cartridge, depth charge projector 2 C80
- Cartridge diameter effect on strength and sensitiveness of expls 2 C80
- Cartridge, full 2 C80
- Cartridge, grenade (rifle and carbine) 2 C80
- Cartridge, hydraulic 2 C80–C81
- Cartridge, igniter for 2 C81
- Cartridge, illuminating 2 C81
- Cartridge, incendiary 2 C81
- Cartridge, photoflash 2 C81
- Cartridge, plastic 2 C81
- Cartridge, pyrot 2 C81
- Cartridge, signal (for grenade launcher) 2 C81
- Cartridge, sintered iron 2 C81
- Cartridge, steel 2 C81
- "Cartridge Strength" 2 C81–C82
- Cartridge tests 2 C82
- Cartridge, zinc-copper alloy 2 C82
- Carvone 2 C82
- Cased charges or expls 2 C82
- Case histories of accidents in the chemical industry 2 C83
- Casein or caseinogen 2 C83
- Casein, nitration 2 C83
- Caseless bomb 2 C83
- Caseless cartridge 2 C83
- Casemate 2 C83
- Casse-blocs "Celtite" 2 C83
- Castan (expl de) 2 C83
- Castan (poudre plate de) 2 C83
- Casteau (expl de) 2 C83
- Castellanos (poudres) 2 C83
- Cast expl 2 C83–C84
- Cast expls of Winning 2 C84
- Casthelaz & Désignolle 2 C84
- Cast proplents 2 C84–C86
 - manufacture of cast composite proplnts 2 C85–C86
 - manufacture of cast homogeneous proplnts 2 C84–C85
 - manufacture of proplnts by slurry casting 2 C85

- Castor oil 2 C87–C88
 analytical 2 C88
 dehydrated 2 C87
 hydrogenated 2 C87–C88
 oxidized 2 C88
- Castro powder 2 C88
- Catactines 2 C88
- Catalysis 2 C88–C89
- Catalyst or catalyzer 2 C89–C90
- Catalysts (rocketry) 2 C90–C91
- Catalytic ignition (rocketry) 2 C91
- Catapult (ancient) 2 C91
- Catapult (modern) 2 C91
- Catapult take-off see Assisted take-off 1 A91
- Catergol 2 C91
- Cathode ray, cathode ray tube and cathode ray oscillograph 2 C91
- Canvet and Baron expls 2 C91–C92
- Caralli, Giovanni 2 C92
- Cavasenza Figli 2 C92
- Cavitation in expl or proplnt charges 2 C92
- Cavité au block de Trauzl ou épreuve au bloc de plomb 2 C92
- Cavity charge performance 1 IX
- Cavity type transducer 2 C92
- CBR see Chemical, biological, and radiological warfare 2 C171–C172
- CBRW 2 C92
- CBS 2 C92
- CBS-128K and CAB-162A 2 C92
- CC 2 C92
- CC see Chemical corps 2 C173
- CC (Cyclonite-cannon) proplnts 2 C92
- CD 2 C92
- CDT (80) 2 C92
- CE 2 C93
- Ceipek's expl 2 C93
- "Cellite" 2 C93
- Celladyne, antifrost 1 A466
- Cellamite 2 C93
- Cellite 2 C93
- Cellobiose and derivs 2 C93
 cellobiose octaacetoles 2 C93
- Cellobiose nitrates 2 C93
- Cellobiose octanitrates 2 C93–C94
- Cellophane 2 C94
- Cellosolve 2 C94
- Cell-pitch lye 2 C94
- Cellular expls of low density 2 C94–C95
- Cellular materials, burning characteristics of 2 C95
- Cellulodine 2 C95
- Celluloid 2 C95
- Celluloidine 2 C95
- Cellulosa 2 C95
- Cellulose and derivs 2 C95–C100
 cellulose and its esters (except NC) analytical procedures 2 C99–C100
 cellulose derivs 2 C98–C99
- Cellulose nitrates (NC) 2 C100–C125
 action of solvents 2 C115–C119
 analytical procedures 2 C119–C123
 blended NCs 2 C106
 guncotton 2 C106–C108
 high-nitrogen NCs 2 C106–C108
 military grades 2 C103
 preparation 2 C101–C103
 properties 2 C101
 pyrocellulose 2 C105–C106
 pyroxylin 2 C103–C106
- Cellulose triacetate see Acetyl celluloses 1 A55–A56
- Celmonite 2 C125
- Celcius, Anders 2 C125
- Celtite 2 C125

- Cement and concrete in Ordnance 2 C125–C126
- Cement, acid-resistant 1 A92–A93
- Cement for lab use 2 C126
- Cement, Pettman 2 C126; 8 P222-P223
- Cement, pyroxylin 2 C126
- Centralites 2 C126–C140
- centralite 1 2 C127–C129
 - centralite 1 analytical procedures 2 C129–C130
 - centralite 1, detn in proplnts 2 C131–C134
 - centralite 1, nitro derivs 2 C134–C135
 - centralite 1, transformation products formed during aging of proplnts containing it 2 C135–C137
 - centralite 2, analytical procedures 2 C138–C139
 - centralite 2, nitro derivs 2 C139
 - centralite 3 2 C139
 - centralite 3, analytical procedures 2 C139
 - centralite 3, nitro derivs 2 C139
 - centralite 3 transformation products formed during aging of proplnts containing it 2 C139
 - centralite 4 2 C140
 - centralite 4, analytical procedures 2 C140
 - centralite 4, nitro derivs 2 C140
 - centralite 4 transformation products formed during aging of proplnts containing it 2 C140
 - centralite, butyl 2 C140
 - centralites, introduction 2 C126–C127
- Centralite R II 2 C140
- Centrifugal casting of metals and expls 2 C140–C141
- Centrifugal force of projectiles and its utilization for arming fuzes and boosters of artillery projectiles 2 C141–C142
- Centrifuge and its applications 2 C142–C143
- Centrifuge test for exudation 2 C143–C144
- Cereal meal 2 C144
- Cereal screenings 2 C144
- Cerium 2 C144
- Cerium azide 1 A528
- Cerium compds for smoke production 2 C145
- Cerium hydroxydiazide 1 A528
- Cerium triazide 1 A528
- Cermets 2 C145
- Cesium 2 C145
- Cesium acetylide-acetylene 1 A72
- Cesium azide 1 A528–A529
- Cesium carbide 1 A72
- Cesium hydrogen acetylide 1 A72
- Cetane number or rating 2 C145
- CF see Cyclohexylmethyl-phosphorofluoridate 5 D1309
- CG 14 2 C145
- CH-6, RDX compn 2 C145
- Chaff, rope, and window countermeasures 2 C145–C146
- Chaff shell or window projectile 2 C146
- Chain (in demolition) 2 C146
- Chain rammer 2 C146
- Chain reaction 2 C146
- Chakatsuyaku (Jap) 2 C146
- Chakoor powder 2 C146
- Chalcone and derivs 2 C146
 - dinitrochalcones 2 C146
 - mononitrochalcones 2 C146
 - trinitrochalcones 2 C146
- Chaleur de combustion (Fr) 2 C147
- Chaleur de detonation (ou d'explosion) (Fr) 2 C147
- Chaleur de formation (Fr) 2 C147
- Chaleur specifique (Fr) 2 C147
- Chalk 2 C147
- Chalon apparatus (test) 1 IX; 2 C147
- Chambre a poudre (Fr) 2 C147
- Chamber of a weapon 2 C147
- Chambering 2 C147
- Chamber pressure 2 C147–C148

- Champion powder 2 C148
 Chanayaku 2 C148
 Chandelon expls 2 C148
 Channel black 2 C148
 Chaoyaku 2 C148
 Chapman expl 2 C148
 Chapman-Jouguet theory see Detonation (and expln) theories 4 D601
 Char de combat (Fr) 2 C148
 Characteristic data (safety) for expl materials 2 C148–C149
 Characteristic products of Berthelot 1 IX
 Characteristics of expls and proplnts 2 C149
 Charbonneaux expls 2 C149
 Charbonnier, P. 2 C149
 Charbonnier's contributions in ballistics 2 C149
 Charcoal 2 C149–C150
 Charcoal, analytical procedures 2 C150
 Charcoal, brn 2 C150
 Charge 2 C150–C151
 explosive 2 C150
 propellant 2 C150–C151
 Charge-amorce (Fr) 2 C151
 Charge creuse (Fr) 2 C151
 Charge de poudre (Fr) 2 C151
 Charge limit 2 C151–C153
 Chargement en comprimé (Fr) 2 C153
 Chargement en fondu (Fr) 2 C153
 Chargement en nougat (Fr) 2 C153
 Chargement des obus (Fr) 2 C153
 Chargement en semoule (Fr) 2 C153
 Charges, proplnt; table of wts, grain dimensions, etc of US artillery ammo 2 C211–C213
 Charge, propelling, earth rod 2 C153
 Charge section 2 C153
 Charge weight ratio 2 C153
 Charlotte ordnance missile plants 2 C154
 Charpy and Izod tests 2 C154
 Chassepot rifle 2 C154
 Chatellerault machine gun 2 C154
 Chatellerault arms plant 2 C154
 Chauchat machine rifle, model 1915 2 C154–C155
 Chauvet powders 2 C155
 Cheddites or Streetites 2 C155–C164
 analytical procedures 2 C161–C163
 chlorate 2 C155–C156
 comps 2 C156–C157; C159
 gelatin type 2 C156, C158
 historical 2 C155
 manufacture 2 C156
 perchlorate 2 C159
 Cheddite-type expls containing azobenzene 1 A647
 Cheddite-type expls used in Finland 2 C164
 Cheesa sticks 2 C164
 Chelation and chelatometry 2 C164–C165
 Chemecol 2 C165
 Chemical agents or chemical warfare agents (CWA) 2 C165–C171
 listing including AC, BA, BBC, CDA, CG, CK, CL, CN, CNB, CNC, CNS, DA, DC, DM, DP, ED, FM, FS, GA, GB, GD, GF, H, HC, HD, HN, HT, KT, L, MD, PD, PS, PWP, Q, T, TH1, TH2, VX, WP 2 C167–C170
 Chemical ammo 2 C171
 Chemical ammo, testing of 2 C171
 Chemical and bacteriological warfare 2 C171
 Chemical, biological and radiological (CBR) warfare 2 C171–C172
 Chemical bombs 2 C172
 Chemical candles 2 C172
 Chemical cellulose 2 C173
 Chemical Corps (CC) 2 C173
 Chemical destruction of expls 2 C173
 Chemical efficiency of mortar 2 C173

- Chemical energy ammo 2 C173
- Chemical factors in proplnt ignition 2 C173
- Chemical fire starters 2 C173
- Chemical fuels for rockets 2 C173
- Chemical grenades 2 C173–C174
- Chemical ground ammo 2 C174
- Chemical gun, howitzers and recoilless rifle shells 2 C174–C175
listing 2 C174–C175
- Chemical ignition 2 C175
- Chemical ignition and flame throwers 2 C175
- Chemical incendiary devices 2 C175
- Chemical industry; case histories of accidents in the 2 C175
- Chemical kinetics and chain reactions 2 C175
- Chemical land mines 2 C175–C176
- Chemical mortar and chemical mortar shells 2 C176
- Chemical mortar, 4.2 inch proplnt for 2 C176
- Chemical munitions 2 C176
- Chemical munitions, destruction, handling, storing, and shipping 2 C176–C177
- Chemical pots or smoke pots 2 C177
- Chemical priming 2 C177
- Chemical problems of space flight 2 C177
- Chemical proplnts 2 C177
- Chemical pulp 2 C177
- Chemical rocket engine 2 C177
- Chemical rocket propulsion and combustion 2 C177
- Chemical rockets 2 C177–C178
- Chemical sprays 2 C178
- Chemical stabilizer 2 C178
- Chemical tests for new explosives 2 C178
- Chemical warfare (CW) 2 C178
- Chemical wood pulp 2 C178
- Chemische Fabrik Dynamites 2 C178
- Chemisorption 2 C178
- Cherenkov (Cerenkov) radiation 2 C178–C179
- Cherokee Ordnance Works 2 C179
- Chiaraviglio and Corbino stability tests 2 C179
- Chicago Ordnance Plant 2 C179
- Chidite 2 C179
- Chikkaen (navy) or Chikka namari (army) (Jap) 2 C179
- Chilworth special powder 2 C179
- China clay 2 C179
- Chishokianin (Jap) 1 A411
- Chitin 2 C179–C180
deacetylated 2 C180
nitrated deacetylated 2 C180
nitrate 2 C180
- Chloramine 2 C181
- o- & m-Chloranilimine pentazidodicuprates 2 C181
- Chlorates 1 C181–C184
analytical procedures 2 C182–C183
- Chlorates, destruction of 2 C184
- Chlorate compds, listing of 2 C184–C202
aluminum chlorate 2 C184
ammonium chlorate 2 C184–C185
anilinochlorates 1 A406
barium chlorate 2 C185–C187
benzylamine chlorate 2 C187
benzylethylamine chlorate 2 C187
benzylmethylamine chlorate 2 C187
cadmium chlorate 2 C187
calcium chlorate 2 C187
chromous chlorate 2 C187
cobaltous chlorate 2 C187–C188
cupric chlorate 2 C188
diethylphenylbenzylammonium chlorate 2 C188
dimethylphenylbenzylammonium chlorate 2 C188
ethylenediamine dichlorate 2 C188
hydrazine chlorate 2 C199
lead chlorate (normal) 2 C188–C189
lead chlorate (basic) 2 C189
lithium chlorate 2 C189

Chlorate compds (cont'd)

- magnesium chlorate 2 C189
- manganese chlorate 2 C189
- mercuric chlorate 2 C190
- mercurous chlorate 2 C190
- nickel chlorate 2 C190
- piperazine chlorate 2 C190
- potassium chlorate 2 C190—C197
- pyridine chlorate 2 C197
- quinoline chlorate 2 C197
- silver chlorate 2 C197
- sodium chlorate 2 C197—C200
- strontium chlorate 2 C200—C201
- tetramethylammonium chlorate 2 C201
- thallous chlorate 2 C201
- o-toluidine chlorate 2 C201
- p-toluidine chlorate 2 C201
- trimethylsulfine chlorate 2 C201
- zinc chlorate 2 C201—C202

Chlorate expls 2 C202—C209

- listing extant in Encycl 2 C202—C207
- properties 2 C207

Chloratite 2 C209

Chlorat-Rivalit 2 C209

Chloratzit 2 C209

Chloratodimercuriacetaldehyde 2 C209

Chloratotrimercuroacetaldehyde 2 C209

Chloric acid 2 C209—C210

Chlorides 3 C236

- detection and determination 3 C236

Chlorides, listing 2 C236—C241

- acetyl chloride 1 A56
- aluminum chloride 3 C236
- aluminum chloride-nitrobenzene complex 3 C236
- ammonium chloride 3 C236—C237
- antimony chloride 3 C237
- arsenic trichloride 3 C237
- azidoacetyl chloride 1 A57
- barium chloride 3 C237
- boron chloride pentahydride 2 B252
- cadmium chloride 3 C237—C238
- calcium chloride 3 C238
- chromium chloride 3 C238
- chromyl chloride 3 C238
- cobalt chlorides 3 C238

Chlorides, listing (cont'd)

- copper chlorides 3 C238—C239
- iron chlorides 3 C239
- mercury chlorides 3 C239—C240
- nitroacetyl chloride 1 A57
- nitrogen chloride 3 C240
- nitrosyl chloride 3 C240
- nitryl chloride 3 C240
- potassium chloride 3 C240
- silver chloride 3 C240—C241
- sodium chloride 3 C241

Chlorinated hydrocarbons and other chlorinated compds 3 C241—C242

Chlorine and compds 3 C242—C244

- acetate 3 C242
- azide 1 A529—A530
- fluorides 3 C242—C243
- oxides 3 C243—C244

Chlorites 3 C244—C245

Chlorite listing 3 C245—C247

- ammonium chlorite 3 C245
- barium chlorite 3 C245
- calcium chlorite 3 C245
- chloropentamine cobalt (III) chlorite 3 C245
- cupric chlorite 3 C245
- hexamine cobalt (III) chlorite 1 A180
- hydrazine chlorite 3 C245
- lead chlorite 3 C245
- mercury chlorites 3 C245
- nickel chlorite 3 C245—C246
- potassium chlorite 3 C246
- silver chlorite 3 C246
- sodium chlorite 3 C246
- strontium chlorite 3 C246
- tetramethylammonium chlorite 3 C246
- thallous chlorite 3 C246
- zinc chlorite 3 C246

Chlor-knallgas 3 C246

Chloroacetylene 3 C246—C247

Chloroaniline and derivs 3 C247

- dinitrochloroanilines 3 C247
- mononitrochloroanilines 3 C247
- trinitrochloroanilines 3 C247

Chloroanilino-propanediol and derivs 3 C247—C248

- dinitrochloroanilinopropanediols 3 C247
- trinitrochloroanilinopropanediol dinitrates 3 C247—C248

- Chloroanisole and derivs **3 C248**
 3-chloro-2-azidoanisole **3 C248**
 mononitrochloroanisole **3 C248**
 trinitrochloroanisole **3 C248**
- 3-Chloro-2-azido-anisole **3 C248**
- Chlorazidobenzenes **3 C249**
- Chloroazobenzene and derivs **3 C248**
 chlorodinitroazobenzene **3 C248**
 chloromononitroazobenzene **3 C248**
 chlorotetranitroazobenzene **3 C248**
 chlorotrinitroazobenzene **3 C248**
- Chlorazodine see Azobis-(chloroformadine)
1 A652
- Chlorobenzene and derivs **3 C248—C251**
 Chlorazidobenzenes **3 C249**
 p-chlorobenzeneazotrinitromethane **3 C251**
 dinitrochlorobenzene **3 C249—C250**
 mononitrochlorobenzene **3 C249**
 tetranitrochlorobenzene **3 C251**
 trinitrochlorobenzenes **3 C250—C251**
 trinitrochlorobenzene, analytical procedures
3 C251
- p-Chlorobenzeneazotrinitromethane **3 C251**
- Chlorobenzoic acid and derivs **3 C251—C252**
 chlorobenzoic acid azide **3 C251—C252**
 dinitrochlorobenzoic acid **3 C252**
 dinitrochlorobenzoic acid azide **3 C252**
- Chlorobenzonitrile and derivs **3 C252—C253**
 dinitrochlorobenzonitrile **3 C252—C253**
 mononitrochlorobenzonitrile **3 C252**
- Chlorobenzoquinone and derivs **3 C253**
 diazobromochlorobenzoquinone **3 C253**
 mononitrodiazochlorobenzoquinone **3 C253**
- Chlorobenzotriazoles see Benzotriazolol and
 derivs **2 B87**
- 3-Chloro-2-butenylthiocyanate **3 C253**
- N-chlorocarbamic acid methyl ester **2 C41—C42**
- 2-Chloro-4-diazo-3-oxido-benzoic acid **3 C253**
- 3-Chloro-4-diazo-2-oxido-benzoic acid
3 C253—C254
- 3-Chloro-5-diazosalicylic acid **5 D1175**
- 1-Chloro-3,5-dimethoxy-2,4,6-trinitrobenzene
3 C254
- Chlorodinitroazobenzene **3 C248**
- 4-Chloro-2,6-dinitro-3-hydroxybenzaldehyde
 semicarbazone **3 C254**
- Chloroethane and derivs **3 C254**
 azidochloroethane **3 C254**
 mononitrochloroethane **3 C254**
- Chloroethanol and derivs **3 C254—C255**
 2-chloroethanol nitrate **3 C255**
 3-nitro-2-chloroethanol **3 C255**
 2-nitro-2-chloroethanol nitrate **3 C255**
- Chloroethylene and derivs **3 C255—C256**
 1-chloro-1-nitroethylene **3 C256**
 polymer of 1-chloro-1-nitroethylene **3 C256**
- Chloroform and derivs **3 C256**
 chloropicrin **3 C256**
- Chlorohydroxyanisole and derivs **3 C257**
 dinitrochlorohydroxyanisole **3 C257**
 mononitrochlorohydroxyanisole **3 C257**
 trinitrochlorohydroxyanisole **3 C257**
- Chlorohydroxybenzaldehyde-(4-nitrophenyl-
 hydrazone) and derivs **3 C257**
 dinitrochlorohydroxybenzaldehyde-(4-nitro-
 phenylhydrazone) **3 C257**
 mononitrochlorohydroxybenzaldehyde-(4-
 nitrophenylhydrazone) **3 C257**
- 6 (or 5)-Chloro-5 (or 6)-hydroxybenzotriazole-
 4,7-quinones **3 C257—C258**
 6,7- (or 4,5)-dichlorobenzotriazole-4,5 (or 6,7)-
 quinones **3 C258**
 6,6,7- (or 4,5,5)-trichloro-4,5 (or 6,7)-dioxo-
 4,5,6,7-tetrahydrobenzotriazoles **3 C258**
- 2-Chloro-3-hydroxy-1-methyl-4-isopropylbenzene-
 6-diazonium chloride **3 C258**
- 6-Chloro-3-iodoxy-pyridine **3 C258**
- 6-Chloro-3-iodoso-pyridine **3 C258**
- 2-Chloro-isonicotinoyl azide **3 C258**
- Chloromethane and derivs **3 C258—C259**
 dinitrochloromethane **3 C259**
 dinitrochlorobromomethane **3 C259**
 dinitrochloriodomethane **3 C259**
 mononitrochloromethane **3 C259**
 nitrosochloromethane **3 C259**
 trinitrochloromethane **3 C259**
- Chloromethylacetylene **3 C259**

- Chloroaminotoluene **3** C260
- Chloromethylaniline and derivs **3** C260–C261
 dinitrochloromethylaniline **3** C260–C261
 dinitro-N-nitroso-chloromethylaniline **3** C261
 mononitrochloromethylaniline **3** C260
 mononitro-N-nitroso-chloromethylaniline
3 C260
 nitrosochloromethylaniline **3** C260
 tetranitrochloromethylaniline **3** C261
 trinitrochloromethylaniline **3** C261
- 2-Chloromethylthiophene **3** C261
- Chloromononitroazobenzene **3** C248
- Chloronitroanilinopropanols **1** A436
- Chloropentaminechromium (III) azide **1** A277
- Chloropentamine cobalt (III) chlorate **1** A280
- Chloropentamine cobalt (III) chlorite
1 A280; **3** C245
- Chlorophenol and derivs **3** C262–C263
 dinitrochlorophenol **3** C262
 mononitrochlorophenol **3** C262
 mononitrodiazochlorophenol **3** C262
 nitrosochlorophenol **3** C262
 2,3,4,6-tetranitro-5-chlorophenol **3** C263
 trinitrochlorophenol **3** C262–C263
- Chlorophenyl-aminotetrazole see 1-Amino-5-
 o-chlorophenyl)- α -tetrazole **1** A193
- 1-(4-Chlorophenyl)-III-cyanoguanyl-triazine
3 C263
- 5-(o-Chlorophenyl)-tetrazole **3** C263
- 1-(1'-o-Chlorophenyl-5'-tetrazolylamino)-5-o-
 chlorophenyltetrazole **3** C263
- 4-Chloro-picolinyl azide **3** C263
- Chloropicrin **3** C256
- Chloropropane and derivs **3** C264–C265
 1-azido-3-chloropropane **3** C264
 diazidochloropropane **3** C264
 dinitrochloropropane **3** C264
 mononitrochloropropane **3** C264
 mononitronitroso-chloropropane **3** C264–C265
 nitrosochloropropane **3** C264
- Chloropropanediol and derivs **3** C265–C267
 3-chloropropane-1,2-diol-1,2-dinitrate
3 C265–C266
- Chloropropanediol and derivs (cont'd)
 2-chloropropane-1,3-diol-1,2-dinitrate **3** C266
 3-chloropropane-2,3-diol-1,2-diol-1-nitrate
3 C265
 mononitrochloropropanediol **3** C266–C267
- Chloropyridine and derivs **3** C267
 dinitrochloropyridine **3** C267
 mononitrochloropyridine **3** C267
- Chlorosilanes **3** C268
- Chlorostyrene and derivs **3** C268–C270
 dinitrochlorostyrene **3** C269–C270
 mononitrochlorostyrene **3** C268–C269
- Chlorotetranitroazobenzene **3** C248
- Chlorotetrazole and derivs **3** C270
- 5-Chloro-2-thenyl chloride **3** C271
- Chlorotoluene and derivs **3** C271–C272
 dinitrochlorotoluene **3** C271–C272
 dinitrosochlorotoluene **3** C271
 2,4,6-trinitro-3-chlorotoluene **3** C272
 2,4,6-trinitro- ω -chlorotoluene see 2,4,6 trinitro-
 benzyl chloride **2** B95
- ω -Chlorotoluene see Benzyl chloride and derivs
2 B95
- Chlorotrinitroazobenzene **3** C248
- Chlorotripentamine cobalt (III) nitrate **1** A279
- 1-Chloro-2,4,6-trinitro-2,4,6-triazaheptane **3** C272
- Chlorous acid **3** C272–C273
- Chloroxylene and derivs **3** C273
 dinitrochloroxylene **3** C273
 mononitrochloroxylene **3** C273
 trinitrochloroxylene **3** C273
- Chlorozon or "Essence de Boulogne" **3** C273
- Choc, essai au (Fr) **3** C273
- Chocolate powder **2** B173
- Choke **3** C273–C274
- Choke bore (artillery) **3** C274
- Choke bore powders **3** C274
- Choke ring **3** C274
- Choking **3** C274
- Choking gas **3** C274

- Cholesterol **3** C274
- Choline **3** C274
 nitratoperchlorate **3** C274
 perchlorate **3** C274
 picrate **3** C274
- Chondrin **3** C274
- Chromates, dichromates, trichromates and tetrachromates **3** C274–C275
 chromates, analytical procedures **3** C275
- Chromates, listing **3** C275–C283
 p-aminobenzene-diazonium chromate **1** A187
 ammonium chromate **3** C275–C276
 barium chromate **3** C276–C279
 calcium chromate **3** C279
 cobalt (II) chromate **3** C279–C280
 copper (II) chromate **3** C280
 lead chromate **3** C280–C281
 strontium chromate **3** C282
 zinc chromate **3** C283
- Chromated NC **3** C289
- Chromathermography **3** C294
- Chromatography **3** C289–C298
 chromathermography **3** C294
 “inverted” **3** C294–C295
 history **3** C289–C290
 ion exchange chromatography **3** C294
 electrochromatography **3** C294
 paper chromatography **3** C292–C294
 partition chromatography **3** C292
 solid-liquid adsorption chromatography **3** C290–C292
- Chrome alum **1** A156
- Chrome-ammonites **3** C298
- Chrome ammonium alum **1** A156
- Chrome greens **3** C298
- Chromel **3** C298
- Chrome plating of gun barrels in Ger **3** C298
- Chrome potash alum **1** A156
- Chrome red or orange **3** C298
- Chrome yellows **3** C298
- Chromic acid **3** C298–C299
- Chromic azide see Chromium triazide **1** A530
- Chromic azide complexes **1** A530
- Chromic oxide **3** C299
- Chromihydrazoic acid, silver complex **1** A531
- Chromite **3** C299–C300
- Chromites **3** C300
- Chromium and its compds **3** C300
 analytical procedures **3** C300
- Chromium azide complexes **1** A530–A531
- Chromium carbide **1** A72
- Chromium chloride **3** C238
- Chromium compds, listing **3** C300–C302
 chromium acetylacetonone **1** A53; **3** C300
 chromium acetylide **1** A72
 chromium (III) ammine complexes **1** A277;
3 C300
 chromium ammonium alum **1** A156
 chromium (III) azidopentammine **1** A277
 chromium borides **3** C301
 chromium carbide **1** A72
 chromium chlorate **2** C187
 chromium (III) chloropentammine azide
1 A277
 chromium compds for smoke production
3 C301
 chromium (III) hexammine complexes **1** A279
 chromium (III) hexaurea complexes **3** C301
 chromium nitrate **3** C301
 chromium picrate, basic **3** C301–C302
 chromium potassium alum **1** A156
 chromium stearate **3** C302
 chromium triamminotetroxide **3** C302
 chromium (III) tris (ethylenediamine) peroxy
 sulfate **3** C302
- Chromium triazide **1** A530
- “Chromosorb” **3** C302
- Chromous chlorate **2** C187
- Chromylacetylacetonone **1** A53
- Chromyl chloride **3** C238
- Chronoamperometry **3** C302–C304
 chronoamperometry **3** C303
 chronopolarography **3** C303
 chronopotentiometry **3** C303
 oscillographic polarography **3** C303

- Chronographs **3** C304–C319
 chronographs and detectors currently used for velocity measurement of projectiles **3** C306–C310
 chronographs and other devices used for measuring detonation velocities of expls **3** C310–C311
 chronographic methods used in US before, during and after WWII **3** C311–C317
- Chronophotography **3** C319
- Chronospectrography **3** C319
- Chrysammidic acid **3** C319
- Chrysene and derivs **3** C319–C320
 dinitrochrysene **3** C320
 mononitrochrysene **3** C320
 tetranitrochrysene **3** C320
- Chrysenedione and derivs **3** C320–C321
 chrysenedione perchlorate **3** C320
 dinitrochrysenedione **3** C321
 mononitrochrysenedione **3** C321
 tetranitrochrysenedione **3** C321
- Chrysoidine **3** C321
- Chuffing see Burning unstable (in rocket motors) **2** B361
- CI **3** C322
- Cibalite **3** C322
- CIA **1** A10
- C.I.A. **3** C322
- Cible (Fr) **3** C322
- CIC **3** C322
- CIC **3** C322
- Cigarette burning **3** C322
- Cigarette fuze (U) **3** C322
- Cilferite **3** C322
- Chinchonamine and derivs **3** C322
 dinitrochinchonamine **3** C322
- Chinchonino-tetraazido-copper **3** C322
- Cine chromatography and radiography **2** C14, C15 & C17
- Cinematography; application in ordnance of, see Cameras, high-speed photographic **2** C13 ff
- Cinnabar **3** C322
- Cinnamic acid and derivs **2** C322–C323
 cinnamic acid azide **3** C323
 cinnamic acid diazonium nitrate **3** C323
 cinnamic acid ozonide **3** C323
 dinitrocinnamic acid **3** C323
 mononitrocinnamic acid **3** C323
 nitrocinnamic acid azides **3** C323
- CIT-4 **3** C323–C324
- Citraconic acid and derivs **3** C324
 citraconic acid azide **3** C324
 citraconic acid, ozonization of **3** C324
- Citric acid and derivs **3** C324
 citric acid azide **3** C324
 citric acid nitrate **3** C324
- Citronellic acid ozonide **3** C324–C325
- Civil engineering, uses of expls in **3** C325
- Civil (or civilian) expls **3** C325
- CK **3** C325
- C-kampfstoffe **3** C325
- CL **3** C325
- CL **2** C167
- Claessen's detonator **3** C325
- Claessen's expl **3** C325
- Claessen's primer and detonator mixtures **3** C325–C326
- Claessen's proplnts **3** C326
- Clarites **3** C326
- Clark I and II see Arsine and derivs **1** A491
- Clarke, E.S. **3** C326
- Clark's expl **3** C327
- Classification of Dynamites **5** D1594–D1595
- Clathrates and other inclusion compds **3** C327–C328
- Clausewitz, Karl von **3** C328

- Clausius (detonation) equation of state 4 D274
- Clay 3 C328
- Cleacid 3 C328
- Cleaning of glassware used in calibration of TNT thermometers 2 C7
- Cleaning of mercury 2 C328–C329
- Cleaning of nitrometer parts 3 C329
- Cleaning solutions for lab glassware 3 C329
- Clees cinematography 3 C329
- Clement or Fuchs powder 3 C329
- Clermonite 3 C329
- Cleveland open cup (COC) 3 C329
- Cleveland Ordnance Plant 3 C329
- Cliffite and super-cliffite 3 C329
- Clift, George D. 3 C329
- Cloramite 3 C329
- Cloratita 3 C329–C330
- Closed bomb (or vessel) and instruments for measuring pressure developed for expls and proplnts 3 C330–C345
 - closed bomb(s) 3 C330, C331–C336
 - historical summary 3 C330–C331
 - instruments for measuring pressure of gases developed on expln 3 C336–C343
 - vented-vessel technique 3 C336
- Closed loop test apparatus for determining the heat transfer characteristics of high energy monopropnlnts 3 C345
- Closed pit (or chamber) test and other fragmentation tests 3 C345–C351
 - closed pit (or chamber) test 3 C346
 - fragment velocity test 3 C350
 - Ger fragment test 3 C350
 - high panel test 3 C350
 - low panel test 3 C350
 - open pit test 3 C346–C349
 - panel test 3 C349–C350
 - silhouette test 3 C350
- Closed vessel test 1 IX; 2 C330–C345
- Cloth, cartridge see Cartridge bags 2 C77
- Cluster 3 C351
- Cluster adapter 3 C351
- Clydite 3 C351
- CMC 2 C65; 3 C351
- CN, CNB, CNC and CNS 2 C167
- Coad expls 3 C352
- Coagulation of NC solns 3 C352
- Coal, and coal mining 3 C352–C357
- Coal, analytical procedures 3 C357
- Coal, cannel 2 C25
- Coal carbonites 3 C357–C358
- Coal dust and its uses 3 C358–C359
- Coal dust bomb 3 C359
- Coal dust; expln hazards from its uses 3 C359
- Coal gasification underground 3 C360
- Coalite (expl) 3 C360
- Coalite (fuel) 3 C360
- Coal mine explns and fires 3 C360–C367
- Coal mines, determination of firedamp and of coal dust in atmosphere of 3 C367–C368
- Coal mining expls; nonpermissible 3 C437–C444
- Coal mining expls, permissible 3 C444–C456
- Coal mining expls, testing for permissibility 3 C368–C378
 - galleries for testing coal mining expls 3 C368–C378
 - US govt regulations and tests for permissible expls 3 C369–C370, C375–C377
- Coal, nitrated 3 C378
- Coal powders 3 C378–C379
- Coal processing for obtaining more valuable products 3 C379
- Coal tar and coal tar pitch 3 C379–C380
- Coating of expl, proplnt and pyrot compositions 3 C380–C383
- Cobalt and its compds 3 C383–C388
 - cobalt, analytical procedures 3 C388
 - cobalt acetylide 1 A72

Cobalt and its compds (cont'd)

- cobaltamine complexes 1 A278–A281;
3 C383
- cobalt azide see cobalt triazide 1 A531
- cobalt azide complexes 1 A531
- cobalt (III) bis (diethylenetriamine) perchlorate
3 C383
- cobalt chlorate 2 C187
- cobalt chromate 3 C279
- cobalt-chromium acetoacetone 3 C383–C384
- cobalt compds for smoke production 3 C384
- cobalt (III) dichlorodiethylenediamine chlorate
and cobalt (III) dichlorodiethylenediamine
perchlorate 3 C384
- cobalt (III) dinitrato-bis (ethylenediamine)
nitrate 3 C384
- cobalt (III) dinitro-bis (ethylenediamine)
nitrates 3 C384
- cobalt (III) dinitro-bis (ethylenediamine)
nitrate 3 C384
- cobalt (III) hexahydroxylamine nitrate 3 C384
- cobalt (II) hydrazine chlorate 3 C384–C385
- cobalt (II) hydrazine nitrate 3 C385
- cobalt (II) hydrazine nitrite 3 C385
- cobalt (II) hydrazine perchlorate 3 C385
- cobalt naphthenate 3 C385
- cobalt (II) nitrate 3 C385
- cobalt (II) nitrate-nitroethylenediamine nitrate
3 C385–C386
- cobalt nitrides 3 C386
- cobalt nitrites 3 C386
- cobalt nitrite complexes 3 C386
- cobalt oxides and hydroxides 3 C386
- cobalt perchlorate 3 C386
- cobalt picrate 3 C386–C387
- cobalt resinate 3 C387
- cobalt stearate 3 C387
- cobalt sulfates 3 C387
- cobalt tetracarbonyl 3 C387
- cobalt (III) tris (ethylenediamine) chlorate
3 C387
- cobalt (III) tris (ethylenediamine) nitrate
3 C387
- cobalt (III) tris (ethylenediamine) perchlorate
3 C387
- cobalt (III) tris (ethylenediamine)peroxysulfate
3 C387

Cobra 3 C388

COC see Cleveland open cup 3 C329

Cochise no 1 3 C388

Cocking, Allen T. 3 C388–C389

Cocoa powder 3 C389

Coconut fiber Dynamite 3 C389

Coefficient d'absorption de NC 3 C389

Coefficient d'échange (Fr) 3 C389

Coefficient de gelatinisation 3 C389
test of Marqueyrol & Florentin 3 C389
test of Ab der Halden 3 C389

Coefficient de gonflement 3 C389

Coefficient de rangement 3 C389

Coefficient de self-excitation (CSE) 3 C390

Coefficient d'utilisation pratique (CUP or cup)
1 IX–X; 3 C390Coefficient de viscosite des nitrocelluloses
industrielles 3 C390

Coefficient de vivacite des poudres 3 C390–C391

Coefficient of gelling (gelatinization) of Soler &
Vian 3 C391

Coefficient of thermal conductivity 3 C391

Coefficient of thermal expansion 3 C391

Coefficient of thermal expansion (linear) 3 C391

Cohete (Span) 3 C391

Cohete guiado (Span) 3 C391

Coke 3 C391–C392

Coke, analytical procedures 3 C392

Cold working of metals 3 C392–C393

Colinite antigrisouteuse 3 C393

Collado 3 C393

Collapsible tube method for depositing ignition
and expl charges in electrical blasting caps
3 C393

Colliard boosters 3 C393

Collieries, blasting in 3 C393–C394

Colliery Cheddite see Cheddites or Streetites
2 C158 (item C)

Collision theory of reaction 3 C394

- Collodion **3** C394
- Collodion cotton see Cellulose and derivs
2 C103, C105
- Collodion cotton-NG gel tests **3** C394
- Colloidal dispersions **3** C395
- Colloidal Dynamites **3** C395–C397
- Colloidal fuel **3** C397–C398
- Colloidal agents and proplnts **3** C398–C403
colloidal proplnts **3** C398–C399
colloidal composite proplnts **3** C401
colloidal double-base proplnts for cannons
3 C400–C401
colloidal single-base proplnts **3** C399–C400
- Colloxyline (kolloksilin) **3** C403
- Cologne powder **3** C403
- Cologne Rottweiler safety powder **3** C403
- Colombia powder **3** C403
- Colophony or rosin **3** C403–C404
- Colophony, nitrated **3** C404
- Colophony–starch mixture **3** C404
- Color **3** C404
- Colorimetry, colorimeter and colorimetric
analysis **3** C404–C405
- Color reactions and color reagents **3** C405–C420
analytical procedures based on color reactions,
a rapid method of identification of common
expl compds and of expl mixtures
3 C411–C417
colorimetric reagents **3** C405–C411
tests for initiating expls **3** C417
tests for proplnts **3** C417–C420
- Colt, Samuel **3** C420
- Colt's pistol powder **3** C420
- Colt's revolvers **3** C420
- Columbia powder **3** C420
- Columbium compds for smoke producing pyrot
items **3** C420
- Combat masterpiece **3** C420
- Combined guidance systems for missiles **3** C420
- Comblain rifle **3** C420
- Comburable (Fr) **3** C420
- Comburant (Fr) **3** C420
- Combustible and consumable cartridge cases and
other items of ammo **3** C420–C424
- Combustion see Burning and combustion **2** B343;
3 C425–C426; **4** D170
- Combustion, erosive of proplnts see Burning,
erosive (in proplnts) **2** B357; **3** C426
- Combustion, expln and shock waves **4** D172
- Combustion (flame) temp of expls; measurements
4 D175
- Combustion (flame) temp of proplnts;
measurements **4** D175
- Combustion instability of rocket proplnts see
Burning, unstable (in rocket motors) **2** B361
- Combustion kinetics, importance in rocket
proplnts **4** D172
- Combustion knock **4** D172
- Combustion of expls see Burning and burning
characteristics of expls **2** B343; **3** C427
- Combustion of proplnts for artillery weapons and
small arms, see Burning and burning character-
istics of proplnts for artillery weapons and
small arms **2** B346; **3** C427–C428
- Combustion of proplnts for rockets see Burning
and burning characteristics of proplnts for
rockets **2** B350; **3** C428; **4** D173; **8** P430–P438,
P449–P455, P458–P467
- Combustion of pyrot compns see Burning and
burning characteristics of pyrot compns **2** B355
- Combustion rate catalysts **3** C429
- Combustion, spontaneous **3** C429–C430
- Combustion tests **1** X
- Combustion theories as applied to solid proplnts
3 C430–C433
combination theory of Riel & Ginell and
Parr & Crawford **3** C432
composite proplnts **3** C432–C433
law of steady heat flow **3** C431–C432
surface theories **3** C431

- Combustion wave propagation **3 C433**
- Comet powder **3 C433**
- Command guidance **3 C433**
- Commercial blasting devices **3 C433–C434**
- Commercial blasting expls, cartridging of **3 C434**
- Commercial boosters **3 C434**
- Commercial detonators see **Blasting cap 2 B185**
- Commercial or industrial expls **3 C434–C459**
 coal mining expls, nonpermissible
3 C437–C444
 coal mining expls, permissible **3 C444–C456**
- Commercial or industrial expls prepared from
 surplus military proplnts **3 C459–C460**
- Commercial plastisols **3 C460**
- Commission des Substances Explosives **3 C460**
- Commission Francaise du Grisou (Fr) **3 C460**
- Common pointed shell **3 C460**
- Compacting of materials **3 C460–C461**
- Compatibility of expls with other substances
3 C461–C462
- Compex **3 C462**
- Complete round of ammo **1 A385**
- Complete round tests **3 C462**
- Complex expls **3 C462**
- Complexometric titrations **3 C462**
- Complex salts contg ammine and nitrate groups
3 C462
- Complex salt of styphnichypophosphoric acids
3 C462
- Component of artillery ammo, tests **3 C462–C464**
- Composite expls see **Binary, ternary and
 quaternary mixtures 2 B116–B120**
- Composite polyurethane proplnts **3 C464**
- Composite proplnts **3 C464–C474**
 castable **3 C465–C467**
 fuels **3 C464**
 molded **3 C467–C468**
 oxidizers **3 C464**
 solvent-extruded **3 C468–C471**
- Compn "106" **3 C474**
- Compn 146-4-G **3 C474**
- Compn I & II **3 C474**
- Compn and properties of various ANG's **1 A368**
- Compn and uses of Ammonals as commercial expls
1 A288–A289;
 mil expls **1 A288–A289**
- Compn A type expls **3 C474–C475**
- Compn A, aluminized **3 A475**
- Compn A type expls, analytical procedures
3 C475–C477
- Compn B type expls and Cyclotols **3 C477–C482**
 compn B-3 **3 C478**
 compn B-4 **3 C478**
 compn B, desensitized **3 C478–C481**
 cyclotols **3 C478, C479–C480**
- Compn B type expls and Cyclotols, analytical
 procedures **3 C482–C484**
- Compn C type expls **3 C484–C486**
 compn C-2 **3 C484**
 compn C-3 **3 C484–C485**
 compn C-4 **3 C485**
- Compn C type expls, analytical procedures
3 C486–C488
- Compn D-2 **3 C488**
- Composition d'amorgage (Fr) **3 C488**
- Composition EL-387A & EL-387B **3 C488–C489**
- Composition fusante (Fr) **3 C489**
- Composition incendiare (Fr) **3 C489**
- Compns, expls **3 C489–C490**
- Compn T-9 **3 C490**
- Compound 335 **3 C490**
- Compound B **3 C490**
- Compound $C_6H_5N_3O_3$ **3 C490**
- Compound $C_6H_6N_3O_6P + H_2O$ **1 A246**
- Compressed air blasting devices **3 C490**
- Compressed NC **3 C490–C491**
- Compressibility of expls **3 C491**

- Compressibility of proplnts 3 C491
- Compression, effect on sensitiveness of initiators 3 C492
- Compression of solids by strong shock waves 3 C492
- Compression test for determination of efficiency of detonators 3 C492
- Compression tests 1 X; 3 C492—C494
- Compression tests for determination of brisance 3 C492—C494
copper cylinder 3 C493
lead block 3 C492—C493
Quinan's method 3 C493—C494
- Compressive and elastic properties of solids under expl attack 3 C494
- Compressors 3 C494
- Comprimee poudre (Fr) 3 C494
- Computers and computer programs 4 D176f
- Computer program for a digital computer 4 D179
- Computer program for an analog computer 4 D179
- CONRAD 3 C494
- CONARC 3 C494
- Concrete in Ordnance use see Cement and concrete in ordn 2 C125
- Concrete tests 1 X; 3 C495
- Concussion 3 C495
- Concussion fuze 3 C495
- Concussion grenade 3 C495
- Concussion primer 3 C495
- Condensation product of EDNA, formaldehyde & ammonia 3 C495
- Condensed electric spark, detonation of expls by 3 C495
- Condensed expls 3 C495—C496
- Condensed phases, testing 4 D179
- Condensed powders see Bulk and condensed powders 2 B322
- Condensed polymerization 3 C496
- Condenser chronograph 3 C496
- Condensers 3 C496
- Conductive and convective heat transfer, thermal expln by 3 C496—C497
- Conductive rubber 3 C497
- Conductivity, electrical; conductivity and conductometric titrations 3 C497—C498
- Conductivity thermal 3 C498
- Conductometric method of analysis of nitric-sulfuric acid mixtures 3 C498
- Cone-charge effect 3 C498
- Cone de charge (Fr) 3 C498
- Confined (or cased) charge 2 C150
- Confinement, effect on the detonation waves in solid expls 3 C498
- Congreve, Sir William 3 C498
- Coniferol 3 C498
- Consistency of commercial expls 3 C498—C499
- Consistency of NC test 2 C122 (test h)
- Constant- α & constant- μ (detonation) equation of state 4 D275
- Constants k_1 and k_2 of Muraour 3 C499
- Constants of expls and proplnts 3 C499
- Constitution of pure expls compds 3 C499—C500
- Constrained shell analysis 3 C500
- Construction of buildings and installations for expls & proplnt plants 3 C500
- Containers for expls 3 C500
- Contat-Gockel valve 3 C500
- Continuous digester for cellulose 3 C501
- Continuous digester for NC 3 C501
- Continuous methods for manufacturing expls 3 C501—C510
description of some processes 3 C502—C510
history 3 C501—C502
- Continuous mixing of castable proplnts at Aerojet General Corp 3 C510
- Control system 3 C510

- Conversion of war-time proplnts to peace-time products **3 C510**
- Convolute wrapping **3 C510**
- Cook-off **3 C510**
- Cook-off temp and its determination **1 X, A354; 3 C510**
- Cool (or cooled) expls **3 C510–C511**
- Cooling agents or coolers **3 C511**
energetic materials requiring **3 C511**
types of substances used **3 C511**
- Cool (or cooled) proplnts **3 C511–C512**
- Cooppal & Cie **3 C512**
- Cooppalite & Nitrocooppalite **3 C512**
Nitrocooppalite V & VIII **3 C512**
- Cooppal powder **3 C512**
- Cooperative build-up of detonation **3 C512–C513**
- Coordinate or dative bond see Bond **2 B241**
- Coordination compds see Ammine or ammoniate and coordination **1 A275**
- Coordination number **3 C513**
- Copolymerization **3 C513**
- Copper and its compds **3 C513–C514**
- Copper-64 and copper-67 **3 C515**
- Copper, analytical procedures **3 C515**
- Copper compds (listing) **3 C515–C528**
copper (I) acetaldehyde catalysts **1 A74–A76**
copper acetates **3 C515**
copper (II) acetoarsenite **3 C515–C516**
copper acetylides and derivs **3 C516**
copper acetylide in electric primer mixtures **3 C516**
copper (I) amide **3 C516**
copper (II) ammine
chlorides **3 C516**
copper (II) ammine expl complexes **3 C516**
copper (II) ammine nitrates **3 C516**
copper (II) ammine sulfates **3 C516**
copper (II) ammonium chloride **3 C517**
copper (II) ammonium sulfites **3 C517**
copper azides **3 C517**
copper azide expl complexes of Circulis & Straumanis **3 C517–C518**
- Copper compds (listing) (cont'd)
copper azidodithiocarbonate **1 A636**
copper (II) bis (ethylenediamine) bromate **3 C518**
copper (II) bis (ethylenediamine) chlorate **3 C518**
copper (II) bis (ethylenediamine) dichromate **3 C518–C519**
copper (II) bis (ethylenediamine) iodate **3 C519**
copper (II) bis (ethylenediamine) nitrate **3 C519**
copper (II) bis (ethylenediamine) nitrite **3 C519**
copper (II) bis (ethylenediamine) perchlorate **3 C519**
copper (II) bis (ethylenediamine) persulfate **3 C519**
copper borates **3 C519**
copper (II) bromate **3 C519**
copper (II) bromotetrazole **3 C519**
copper carbonates **3 C519–C520**
copper (II) chlorate **3 C520**
copper chlorides **3 C238–C239**
copper (II) chloride azide **1 A533**
copper (II) chromate **3 C280**
copper compds for smoke production **3 C520**
copper (II) ethylenediamine complexes **3 C520**
copper formates **3 C520**
copper (I) fulminate **3 C520**
copper fulminate expls complexes **3 C520–C521**
copper (II) hydrazine chlorate **3 C521**
copper (II) hydrazine nitrate **3 C521**
copper (II) iodate **3 C521**
coppermethyl **3 C521**
copper (II) mono (ethylenediamine) azide **3 C521**
copper (II) mono (ethylenediamine)-tetraaquo perchlorate **3 C521**
copper naphthenate **3 C521**
copper nitrates **3 C521–C522**
copper nitroaminoguanidine **1 A212**
copper oxalates **3 C522**
copper oxides and hydroxides **3 C522–C524**
copper oxychlorides **3 C524–C525**
copper perchlorates **3 C525**
copper phthalocyanine **3 C525**
copper picramates see Amino-phenols and derivs **1 A242**
copper (II) resinate **3 C525**
copper (II) salicylate **3 C526**
copper (II) stearate **3 C526**

- Copper compds (listing) (cont'd)
 copper (II) sulfate ammoniated 3 C526
 copper sulfates 3 C526—C527
 copper sulfides 3 C527
 copper thiocyanates 3 C527—C528
 copper (II)-2,4,6-trinitrobenzoate 3 C528
 copper (II) tris (ethylenediamine) bromate
 3 C528
 copper (II) tris (ethylenediamine) chlorate
 3 C528
 copper (II) tris (ethylenediamine) nitrate
 3 C528
 copper (II) tris (ethylenediamine) perchlorate
 3 C528
- Copper cylinder compression (or crushing) test
 1 X; 2 B299; 3 C528
- Copper value of cellulose 3 C529
- Coppering 3 C529
- Copula furnace expln 3 C575
- Corajo, ivory nut 3 C529
- Corbette-type magazine 3 C529
- Cord, detonating (Cordeau) 3 C529—C531
- Corde a feu 3 C531
- Cordeau 3 C531
- Cordeau Bickford see Bickford fuse 2 B112
- Cordeau combustible 3 C531
- Cordeau d'amorce (Fr) 3C531
- Cordeau detonant (Fr) 3 C531
- Cordeau Maissin 3 C531
- Cordite 3 C531—C536
 flashless 3 C532—C533
 foreign 3 C535
 Mark 1 3 C532—C533
 MD or MC 3 C532—C533
 solventless 3 C534—C535
 RDB 3 C532, C533—C534
- Cordite, manufacture of NC 3 C536—C539
 Abel's process 3 C536—C537
 centrifugal 3 C537—C538
 direct dipping process 3 C537
 displacement process of Thomson 3 C538—C539
 DuPont's process 3 C539
- Cordite, analytical procedures 3 C539—C540
- Cord-like ignition device for expl charges 3 C541
- Cork 3 C541
- Cork, carbonized 3 C541
- Cork powder expls 3 C541—C542
- Cornaro's expls 3 C542
- Corncob cellulose 3 C542
- Corner (detonation) equation of state 4 D276
- Corner's equation of state 3 C542
- Cornet powder 3 C542—C543
- Cornhusker Ordnance Plant 3 C543
- Cornil or poudre blanche 3 C543
- Corning mill dust 3 C543
- Cornish powder 3 C543
- Cornstalk expls 3 C543
- Coronite or permittite 3 C543
- Corporal (missile) 3 C543
- Corpse light 3 C543—C544
- Correlation of expl properties with other
 parameters 3 C544
- Corresponding states, law of 4 D194
- Corrosion 3 C544—C545
- Cortex 3 C545
- Corteza de seguridad 3 C545
- Corvus 3 C545
- Cosilit 3 C545
- Cosmotron 3 C545
- Coton see Collodion cotton 2 C103; 3 C545
- Coton poudre see Guncotton 2 C106; 3 C545
- Coton, poudre au 3 C545
- Coton pyrique (Fr) 2 C105
- Cotter powder 3 C545
- Cotton 3 C545—C546
- Cotton, chemical 3 C546—C547
- Cotton linters 3 C547
- Cotton (or cellulose), copper index 3 C547

- Cottrell, Frederick G. 3 C547
- Cottrell-Paterson equation of state 3 C547; 4 D276
- Coumaranone and derivs 3 C547–C548
 2-azido-3-coumaranone 3 C548
 5,7-dinitro-3-coumaranone 3 C548
 mononitrocoumaranone 3 C548
- Coumaric acid and derivs 3 C548–C549
 dinitrocoumaric acid 3 C549
 mononitrocoumaric acid 3 C549
- Coumarilic acid and derivs 3 C549
 coumarilic acid azide 3 C549
 mononitrocoumarilic acid 3 C549
- Coumarin and derivs 3 C549–C550
 3,6,8-trinitrocoumarin 3 C551
- Coumarone see 2,3-Benzofuran 2 B67
- Coumarone-indene resins 3 C550
- Counter chronograph 3 C309
- Counterinsurgency warfare 3 C550
- Coup complet (Fr) 3 C550
- Coup de poussiere (Fr) 3 C550
- Courteille powder 3 C550
- COV 3 C550
- Covolume 3 C550–C551; 4 D196
- Covolume and the condition of gases of decompn
 in the detonating zone of brisant expls 4 D196
- Covolume (detonation) equation of state 4 D276
- Coyote tunnels 3 C551
- CP₁ and CP₂ (Fr) see Collodion cotton
 2 C103; 3 C551
- CP₂ SD (Fr) 2 C105; 3 C551
- CP₃ (Fr) see Collodion cotton 2 C105; 3 C551
- Cp100 (Fr) 3 C551
- CPN-112C 3 C551
- CPN-115A 3 C551
- CPN-123 3 C551
- CPN-127A 3 C551
- CPN-135 3 C552
- “C” process 3 C552
- CQE 3 C552
- Cracking 3 C552
- Cracking gas 3 C552
- Crack-preventing additives to cast expls see
 Anti-cracking additives to cast expls
 1 A461–A462
- Cradle, bomb 3 C552
- Cradle, cannon 3 C552
- Crankcase expln in oil engines 3 C552
- Cranz, Carl Julius 3 C552–C553
- Cratering charge 3 C553
- Cratering effect 1 X; 3 C553
- Cratering effect tests 3 C554–C555
- Crater, W. de C. 3 C555
- Cratiti 3 C555
- Crawford bomb 3 C555
- Crawshaw-Jones apparatus 1 X; 3 C555
- Creep 3 C555
- Creep behavior of proplnt material 3 C555
- Creep force of a projectile 3 C555
- Cremieux, Israel 3 C555
- Cremonita 3 C556
- Cremonita 3 C556
- Cresol and derivs 3 C556–C558
 dinitrocresols 3 C556–C557
 mononitrocresols 3 C556
 tetranitrocresols 3 C558
 trinitrocresols 3 C557
- Cresolsulfonic acid and derivs 3 C558
 ammonium mononitrocresolsulfonate 3 C558
 C-mononitro-m-cresolsulfonate 3 C558
 Rachite III & IV 3 C558
 sodium mononitrocresolsulfonate 3 C558
- Creuse charge 2 C151
- Cresylates and other derivs of nitrated cresols
 3 C558–C560
 a double salt; lead nitrato-bis-(basic lead-4-6-
 dinitro-o-cresylate) monohydrate 3 C559

- Cresylates and other derivs of nitrated cresols (cont'd)
 complexes of trinitrocresol plus albylamine, acenaphthene, fluorene, or naphthalene 3 C560
 salts of trinitrocresylate; aluminum, ammonium, barium, calcium, cupric, ferric, ferrous, lead, magnesium, potassium, silver, sodium, thallium & zinc 3 C558—C559
- Crimper, blasting cap 3 C560
- Crimping 3 C560
- Criterion of explosiveness 4 D196
- Critical conditions in thermal expln theory with reactant consumption 3 C 560
- Critical constants of liquid expls 3 C560
- Critical diameter 3 C560—C561
- Critical diameter of liquid expls 4 D197
- Critical diameter of solid expls 4 D198
- Critical mass 3 C561; 4 D201
- Critical phenomenon 4 D201
- Critical point 4 D201
- Critical pressure valve 4 D202
- Critical velocity 3 C561
- Cronite 3 C561
- Cronquist, Albert Werner 3 C561
- Cross and Bevan cellulose 3 C561
- Crossbar shot 3 C562
- Crossbow see Arbalest 1 A477.
- Cross, Charles F. 3 C562
- Crosslinking agents for NC 3 C562
- Crotonic acid and derivs 3 C562—C563
 crotonyl azide 3 C563
- Crown oil E 3 C563
- CR (Cyclonite) rifle proplnts 3 C563
- Cruciform 3 C563
- Cruciform luminosity produced by detonation of expl cartridges of square cross section 3 C563—C564
- Crusher gage 3 C564
- Crusher (crushing) tests 1 X; 3 C564
- Crushing and grinding 3 C564—C567
 crushers 3 C564—C565
 grinding mills 3 C565—C566
- Crushing impact, sensitivity of expls to 3 C567
- Cryogenic liquids 3 C567
- Cryolite 3 C567
- Cryoscopic method 3 C567
- Cryostat 3 C567
- Crystal 3 C567
- Crystallization 3 C567—C568
- Crystallization of expls 3 C568
- Crystallography, crystals and crystallochemical analysis 3 C568—C570
 crystallochemistry 3 C569
 crystallographic systems 3 C569
 crystallography 3 C569
- CS 3 C570
- CSC 3 C570
- CSE (Fr) see Coefficient de self-excitation 3 C390 see Gap test 1 XIV
- CSE (Fr) 3 C570
- CSE (expls) 3 C570—C571
- CSP 2 3 C571
- CS powder see CSP 3 3 C571
- C-stoff 3 C571
- CTMTU see Cyclo-trimethylene-triurethane 3 C633
- CU 3 C571, C573
- Cube powder 3 C573
- Cugnite 3 C573
- Cuirasse (Fr) 3 C573
- Cuirasse (Fr) 3 C573
- Culasse (Fr) 3 C573
- Culverin 3 C573

- Cumene and derivs **3 C573–C575**
 α -azidocumene **3 C573**
 cumene hydroperoxide **3 C574–C575**
 dinitrocumene **3 C574**
 mononitrocumene **3 C573–C574**
 monohalogen derivs **3 C574**
 β,β,β' -trinitrocumene **3 C574**
 2,4,6-trinitrocumene **3 C574**
- Cumulative initiation or ignition **3 C575**
- CUP or cup test (Fr) **1 X**
- Cuprammonium solution **3 C575**
- Cuprates with organic cations **3 C575–C576**
- Cuprene **3 C576**
- Cuprene tar **3 C576**
- Cupric acetylide see Acetylides and carbides
 1 A74; 3 C516
- Cupric amminoazide **1 A533**
- Cupric azide **1 A532–A533**
 expl properties **1 A532–A533**
 preparation and properties **1 A532**
- Cupric azide, basic **1 A533**
- Cupric azide complexes **1 A533–A534**
- Cupric chlorate **2 C188**
- Cupric chlorite **3 C245**
- Cupric compds see Copper (II) compds **3 C515**
- Cupric expl salts **3 C576**
- Cupric tetramminothiosulfate **3 C576**
- Cuprous acetylide **1 A72–A74; 3 C516**
- Cuprous azide **1 A534–A535**
 expl properties **1 A534–A535**
 preparation and properties **1 A534**
- Cuprous compds see Copper compds **3 C520**
- Cuprous fulminate see Copper compds listing
 3 C520
- Cuprous sodium acetylidothiosulfate
 3 C576–C577
- Cups, percussion or primer; and caps **3 C577**
- Curds **3 C577**
- Curena, afuste or montaje del canon (Span) **3 C577**
- Curie, Marie Sklodowska **3 C577**
- Curie, Pierre **3 C577–C578**
- Curing of proplnts see Ageing of proplnts **1 A112**
- Curme, George Oliver Jr **3 C578**
- Current non-permitted expls **3 C578**
- Current permitted expls **3 C578**
- Curtis & Andre powder **3 C578**
- Curtis & Durnford powder **3 C578**
- Curtisite **3 C578**
- Curtius rearrangement **3 C578–C579**
- Curtius, Theodor **3 C579**
- Curvature of wave fronts **4 D202**
- Cushion blasting **3 C579**
- Cut holes **3 C579**
- Cutocellulose see Adipocelluloses **1 A104**
- Cutoff expl charge **3 C579**
- Cutoff expl charge, hazards of in multiple blasting
 3 C579
- Cut powders **3 C579**
- Cut shots & drifting **3 C579**
- Cutters see Cartridges and cartridge actuated
 devices **2 C71**
- Cutting **3 C580**
- Cutting charge see Charge **2 C150**
- Cutting of metal plates with HE charges **3 C580**
- CW see Chemical warfare **2 C178**
- CWA see Chemical agents **2 C165–C171**
- Cyanamide and derivs **3 C580–C582**
 cyanamide salts and other derivs **3 C580–C582**
- Cyanic acid and its salts **3 C582–C583**
 cyanates **3 C582**
 cyanides **3 C582**
 cyanides, diazo **3 C583**
- Cyanide safety expls **3 C583**
- Cyano **3 C583**

Cyanocompds 3 C583–C589

- azidocynoacetamide 3 C583
- cyanazide 3 C583
- cynoacetamide 3 C583
- cynoacetic acid 3 C583
- cynoacetyl azide 3 C583
- cynoacetylene 3 C585
- cynoacetyl hydroxide 3 C584
- cynoazidothiocarbonate 1 A635
- cynoazoguanidine 3 C587–C588
- 6-cyanobenzazimidole 3 C585
- cyanocompds (poly) 3 C589
- N-(2-cyano-4,6-dinitrophenyl)-N-nitroaminoethyl nitrate 3 C585
- cyanodiphenylamine see Anilinobenzonitrile 1 A422
- cynoethyl nitrate 3 C585–C586
- cynoformamidine azide 3 C586
- cyanogen 3 C586
- cyanogen bromide 3 C586
- cyanogen chloride see CK 2 C167
- cyanogen iodide 3 C586
- cyanoguanidine 3 C587
- cyanoguanidine nitrate 3 C588
- cyanohydrazine 3 C588
- cyanomethane see cyanomethyl nitrate 3 C588
- cyanomethylnitrolic acid 3 C588
- 5-cyano-(α -tetrazole) 3 C588–C589
- isonitrosocynoacetic acid 3 C584
- isonitrosocynoacetic acid methyl ester 3 C584
- isonitrosocynoacetyl hydrazide 3 C584–C585
- isonitrosocynoacetyl azide 3 C584
- nitrocynoacetamide 3 C583
- nitrocynoacetic acid 3 C584
- nitrocynoacetic acid ethyl ester 3 C584
- nitrocynoacetic acid methyl ester 3 C584
- nitrocynoacetyl azide 3 C584
- nitrocynoacetyl hydrazide 3 C584
- nitrocyanoguanidine 3 C588

Cyanuramide 3 C589

Cyanuramide diazide 3 C589

Cyanurea 3 C589

Cyanuric acid 3 C589

Cyanuric chloride 3 C589–C590

Cyanuric dihydrazide azide 3 C590

Cyanuric hydrazide diazide 3 C590

Cyanuric triazide 3 C590

Cybernetics 3 C591; 4 D203

Cycene 3 C591

Cyclic ketone alcohols 3 C591–C592

Cycloalkanes, peroxide derivs of 3 C592

- the following derivs are listed: dicyclopentylidene peroxide, 1,1'-dihydroxydicyclohexyl-1,1-peroxide see Bis (1-hydroxy-cyclohexyl)-peroxide 2 B145
- 1,1'-dihydroxy-dicyclopentyl-1,1'-peroxide, 1-hydroxycyclohexyl-1-hydroperoxide, cyclohexyl peroxide, 1-1'-dihydroxydicyclooctyl-1,1'-peroxide, 1-hydroxy-3-methylcyclohexyl-1-hydroperoxide, 1-hydroxycycloheptyl-1-hydroperoxide, 1-hydroxy-cyclooctyl-1-hydroperoxide, 1-hydroxycyclopentyl-1-hydroperoxide, polycyclopentylidene peroxide 3 C592

1,6-Cyclodecanedione 3 C592–C593

- 1,6-cyclodecanedione dioxime, dimeric 3 C593
- 1,6-cyclodecanedione peroxide 3 C593

Cyclodiazoo compds 3 C593

- cyclodiazobutane 3 C593
- cyclodiazooethane 3 C593
- cyclodiazomethane 3 C593

Cyclo-di (diethylether)-oxyperoxide 3 C593

Cyclo-di-(α,α -diethyletherperoxide) 3 C593

Cyclodioxytetramethylene diperoxide 3 C594

Cyclodioxytrimethylene peroxide 3 C594

Cyclofive 3 C594

Cycloheptane 3 C594

Cyclohexadiene 3 C594–C595

Cyclohexadiene peroxide 3 C595

Cyclohexane and derivs 3 C595

- cyclohexyl azide 3 C595
- 1,2-dinitrocyclohexane 3 C595
- mononitrocyclohexane 3 C595

Cyclohexanediol and derivs 3 C595–C596

- cyclohexane-1,2-diol dinitrate 3 C596

Cyclohexanetriol and derivs 3 C596

- cyclohexane-1,2,3-triol trinitrate 3 C596

Cyclohexanol 3 C596

- Cyclohexanone **3** C597
 2,6-dinitrocyclohexanone **3** C597
 2-nitrocyclohexanone **3** C597
- Cyclohexanone oxime **3** C597–C598
- Cyclohexanone peroxide(s) **3** C598–C599
- Cyclohexene and derivs **3** C599
 cyclohexene nitrosate **3** C599
 cyclohexene nitrosite **3** C599
 cyclohexene ozonide **3** C599
 1-nitrocyclohex-1-ene **3** C599
- N-Cyclohexylacetanilide **3** C599–C600
- Cyclohexylaminoethanol **3** C600
- Cyclohexyl-NENA **3** C600
- Cyclohexylaniline and derivs **3** C600–C601
 N-cyclohexyl-2,3-dinitroaniline **3** C600
 N-cyclohexyl-2-nitroaniline **3** C600
 N-cyclohexyl-N-nitro-N'-picryloxamide
3 C600–C601
 N-cyclohexyl-N-nitro-2,4,6-trinitroaniline
3 C600
 N-cyclohexyl-2,4,6-trinitroaniline **3** C600
- Cyclohexyl azide **3** C595
- Cyclohexyltoluidine and derivs **3** C601
 dinitrocyclohexyltoluidine **3** C601
 mononitrocyclohexyltoluidine **3** C601
 x-trinitro-2-cyclohexyltoluidine **3** C601
- Cyclonite see Cyclotrimethylenetrinitramine
3 C611–C624; also RDX **9** R120–R145
- Cyclonite-nitromethane mixture **3** C601
- Cyclonite oxide **3** C601–C602
- Cycloparaffins **3** C602
- Cyclopentadiene and derivs **3** C602
 5-nitro-1,3-cyclopentadiene **3** C602
- Cyclopentane and derivs **3** C602–C603
 cyclopentane-1,2-dicarbonyl azide **3** C603
 cyclopentyl azide **3** C603
 nitrocyclopentane **3** C603
 1-nitro-1 (or 2)-nitrosocyclopentane **3** C603
- Cyclopentanone and derivs **3** C603–C605
 cyclopentanone peroxides **3** C604–C605
 nitrocyclopentanone **3** C604
- Cyclopentene monomeric ozonide **3** C605
- Cyclopropane and derivs **3** C605
 mononitrocyclopropane **3** C605
- Cyclopropylacetylene **3** C605
- “Cyclops” **3** C605
- Cyclotetramethylenetrinitramine **3** C605–C610;
 see HMX **7** H162; also 1,3,5,7-tetranitro,
 octahydro-1,3,5,7-tetrazocine **9** T83–T99
 analytical procedures **3** C608–C609
 expl and other properties **3** C606–C607;
9 T83–T92, T93, T95–T98
 preparation and manufacture **3** C606;
9 T92–T93
 uses **3** C607; **9** T93, T98–T99
 US military specification **3** C607–C608
- Cyclotols **3** C478, C479–C480
- Cyclo-2,4,5-trimethylene-1,3-diamine and derivs
3 C610–C611
 1,3-dinitro-cyclo-2,4,5-trimethylene-1,3-
 diamine **3** C611
- Cyclotrimethyleneimine see Azetidine
1 A518–A519
- Cyclotrimethylenetrinitramine (Cyclonite or
 RDX) **3** C611–C624; RDX **9** R120–R146
 analytical methods **3** C624–C626;
9 R140–R143
 chemical properties **3** C615–C619;
9 R123–R124
 combustion and DDT **9** R133–R140
 disposal of waste RDX **3** C621; **9** R141–R142
 expl properties **3** C615–C619; **9** R124–R128
 history **3** C611–C613
 initiation properties **9** R128–R133
 international specifications **3** C620–C621
 physical properties **3** C611, C615;
9 R120–R121
 preparation **3** C613–C614
 RDX detonators **9** R143
 recovery of RDX **3** C621
 thermal and thermochemical properties
9 R122–R123
 toxicity **3** C611; **9** R142–R143
 uses **3** C619–C620
 US military specifications **9** R143–R144
- Cyclotrimethylenetrinitramine (RDX), analytical
 procedures **3** C624–C626; **9** R140–R141
 qual tests **3** C624–C625
 quant tests **3** C625–C626

Cyclotrimethylenetrinitramine (RDX or Cyclonite) binary, ternary and other expl mixts
3 C626—C630

America (USA) 3 C626

France 3 C626—C627

Germany 3 C627

Italy 3 C627

Japan 3 C627—C628

Russia 3 C628

Spain 3 C628

Sweden 3 C628

Switzerland 3 C628

Cyclotrimethylenetrinitramine (Cyclonite)
homolog 3 C630

Cyclotrimethylenetrinitrosamine (R-salt)
3 C630—C632

expl and other properties 3 C631

preparation 3 C630—C631

uses 3 C631, C632

R-Salt see Cyclotrimethylenetrinitrosamine
3 C630—C632

Cyclotrimethylenetrinitrosamine (R-salt),
analytical procedures 3 C633

Cyclotrimethylenetriurethane 3 C633

Cyclotron 3 C633—C634

CYH 3 C634

CYH (77) 3 C634

CYI (75) 3 C634

Cylinder barrel 3 C634

Cylinder, recoil 3 C634

Cylindrical explns 3 C634—C636

Cymenes 3 C637

nitrocymenes 3 C637

Cystamine 3 C638

CZ 3 C638

Czech arms and weapons plants 3 C638

- D 3 D1**
D (Fr) 3 D1
D-1 3 D1
D-2 3 D1
DA 3 D1
DADN Ph see 4,6-Dinitrobenzene-2-diazo-1-oxide 2 B59; 5 D1160–D1163
DAF 3 D1
Dagger 3 D1
Daggs 3 D1
Dahmen, Johann, Von 3 D1
Dahmenit A 3 D1
Daisite 3 D1
Daisy cutter bomb 3 D1–D2
 blue steel stand-off bomb **3 D2**
Daisy photoflash cartridge 3 D2–D3
 daisy recoilless slug **3 D2**
Damage effects of organic HE 3 D2
Damage potential of air and ground blast waves 3 D3–D4
Damming of expls 3 D4
Damper 3 D4
DANC soln 3 D4
Danger of expln 3 D4–D5
Danger of handling expls 3 D5–D6
Dangerous (hazardous) chemicals and other materials 3 D10–D15
Dangerous materials, shipping and storage of 3 D16
Danyaku (Jap) 3 D16
Dapremont's powder 3 D16
Darapsky's incendiary compn 3 D16
Darcet alloy 3 D17
Dark and dim igniters 3 D16–D17
Darrieus effect 3 D17
Dart 3 D17
Dart composite propnt, CBS 128K 3 C17
Darts 3 D17
Dash 3 D17
Dashpot 3 D17
Dashpot, anchor, underwater mine 3 D17
DATB see 2,4,6-Trinitro-1,3-diaminobenzene 5 D1130–D1131
DATB–HMX expl compns for high temp resistance and high energy 3 D17
DATNB see 2,4,6-Trinitro-1,3-diaminobenzene 5 D1130–D1131
Dautriche, H. 3 D17
Dautriche method for determination of velocity of detonation 1 X; 3 D17
Davey's powder 1 3 D17
Davey's powder 2 3 D17–D18
Davey's powder 3 3 D18
Davey & Watson's powder 3 D18
Davies & Curtis' safety expl 3 D18
Davies powder 3 D18
Davies safety expl 3 D18
Davis ammonia process 3 D18
Davis, Tenney L. 3 D18
Davy Crocket 3 D18
Davy, Sir Humphry 3 D18
Dawson & Karstairs powders 3 D18
DB 3 D18–D19
DBP or DiBuPh see Dibutyl-o-phthalate 5 D1197–D1199
DBX 3 D19
DC 3 D19
DD device 1 A392 see Amphibious devices for tanks 1 A392
DD explosifs 3 D19

- DDP 3 D19
 DDP (proplnt) 3 D19
 DDP 70 (proplnt) 3 D19
 DDP 77 (proplnt) 3 D19
 DT 3 D19
 Deactivated apparatus 3 D19–D20
 Dead-cooling 3 D20
 Dead cotton 3 D20
 Dead oil 3 D20
 Dead-pressed expls 3 D20
 Dead shot powder 3 D20–D21
 Dead-stop end point method of titration 3 D21
 Deal polytropic (detonation) equation of state
 4 D276
 Dean expl 3 D21
 Dean-Stark tube 3 D21
 1-Deazadenine picrate 3 D21
 Decaboron 2 B254–B255
 Decalin and derivs 3 D21–D22
 decalin hydroperoxide 3 D22
 decalin nitrated derivs 3 D22
 Decanitrocellulose 3 D22
 Decantation 3 D22
 Decolorization 3 D22–D23
 Decomposition, destruction and disposal of ammo,
 expls, proplnts and pyrot compns 3 D23–D35
 alphabetical listing of procedures for individual
 expls & proplnts 3 D29–D33
 decomposition of expls 3 D23–D25
 destruction and disposal of expls 3 D25–D29
 Decomposition, influence of pressure and temp on
 4 D205
 Decomposition, thermal of expls and proplnts
 4 D204
 Decontaminating agent DS₂ 3 D35
 Decontaminating agent STB 3 D35–D36
 Decontamination 3 D36
 Decontamination of expl establishments 3 D36
 Decontamination of waters containing dissolved
 expl wastes 3 D36
 Decoppering agent 3 D36–D37
 Decoupage des poudres 3 D37
 DeCustro expl 3 D37
 Deep bonding process for AP projectiles
 3 D37–D38
 Deep hole drilling with expls 3 D38
 Defeat of armor 3 D38
 Defense against chemical warfare 3 D38
 Defense, civil 3 D38
 Defense system, antiaircraft 3 D38
 Deflagrating expls and deflagration 3 D38–D40;
 4 D207
 Deflagration 4 D207–D208
 development from burning of expls and
 proplnts 4 D207
 in powdered expls 4 D208
 Deflagration point of graphite oxide 4 D208
 Deflagration temperature test 1 XVI–XVII;
 3 D40; see Flash point 6 F80–F96
 Deflection (in gunnery) 3 D40
 Deflectometers vs strain gages 3 D40
 Deformation and fracturing of thick-walled steel
 cylinders under expl attack 3 D40
 Defraiteur's expls 3 D40–D41
 Defuze 3 D41
 DEGDN or DEGN 5 D1232–D1233
 Degradation and deterioration of cellulose 3 D41
 Degradation and deterioration of expl jellies 3 D41
 Degradation and deterioration of expls in storage
 3 D41
 Degradation and deterioration of proplnts in
 storage 3 D41
 Degradation of NC solns 3 D41–D42
 Degressive burning proplnts 3 D42

- Degtiarev, V.A. 3 D43
- Dehydrating and drying agents 3 D43
- Dehydrating value of sulfuric (DVS) in mixed acids 3 D43–D44
- Dehydration or drying of NC 3 D44–D47
lab methods 3 D45
plant methods 3 D45–D47
- Dehydration or drying of smokeless propnlts 3 D47–D49
double-base solvent propnlts 3 D48
single-base propnlts 3 D47–D48
solventless double-base propnlts 3 D48–D49
- Dehydrogenation 3 D49
- Dehydronicrylpiperidine, nitro deriv 3 D49
- Deissler 3 D49
- Deissler & Kuhnt 3 D49
- Delattre expl 3 D49
- Delay 3 D49
- Delay action bomb 3 D49
- Delay, arming 3 D49
- Delay blasting cap 3 D49–D50
- Delay charges, compns or powders 3 D50–D52
boron compns 3 D50
exotic compns 3 D50
manganese compns 3 D50
zirconium-Ni compns 3 D50
- Delayed action bomb see Bombs, delayed action 2 B239
- Delayed contact fired 3 D52
- Delay element 3 D52
- Delay elements, gasless, and detonators employing them 4 D863
- Delayer 3 D52–D53
- Delay, expl train 3 D53
- Delay, functioning 3 D53
- Delay igniters 3 D53
- Delay items, Black Powder 4 D857
- Delay miniature initiators 3 D54
- Delay-relay element 3 D54
- Delay release assembly 3 D54
- Delay to ignition and its temp coefficient 3 D53–D54
- Delepine, Marcel 3 D54
- Delhorbe (explosif) 3 D54
- Deliquescence of expls 3 D54–D55
- Deliquescence test 1 X, XVI; see Hygroscopicity 7 H251–H254
- Delivered or characteristic velocity 3 D55
- Delivery error 3 D55
- Delivery system 3 D55
- Delmhorst moist indicator 3 D55
- Delta rocket 3 D55
- Delvigne expl 3 D55
- De Macar expls or Macarites 3 D55
- De Marre formula 3 D55
- Demetriade, Jonesen & William expl 3 D55
- Demi-culverin see Culverin 3 C573
- Demilitarization 3 D55
- Demolition 3 D55
deliberate 3 D56
hasty 3 D56
- Demolition bangalore torpedoes 2 B16, B227–B228
- Demolition bombs 2 B239
- Demolition clam 3 D56
- Demolition expls 3 D56–D61
British 3 D58
French 3 D58–D59
German 3 D59
Japanese 3 D59–D60
Russian 3 D60
US forces 3 D57–D58
- Demolition hoses see Bangalore torpedoes 2 B17
- Demolition kit 3 D61–D62
bangalore torpedo 3 D61
blasting 3 D61
M37 3 D61
M157 "smoke" 3 D61
petard type 3 D61

- Demolition kit (cont'd)
 projected charge 3 D61
 training 3 D61
- Demolition materials 1 A384 see Demolition expls
 3 D56–D61
- Demolition of prestressed concrete bridge beams
 with expls 3 D62
- Demolition sled, M3 3 D62
- Demolition rocket, 7.2 inch 3 D62
- Demolition snakes see Bangalore torpedoes
 2 B17–B18
- Denaby powders 3 D62–D63
- Denatured (or industrial) alcohol 3 D63
- Denespex 3 D63
- Deniges, Georges 3 D63
- Denitration 3 D63–D64
 NC articles 3 D63
 nitroguanidine 3 D63
 D-mannitolhexanitrate 3 D63
 sulfuric acid 3 D63–D64
- Denitration test 3 D64
- Dense proplnt ignition compn 3 D64
- Densite (Fr) 3 D64
- Densites 3 D64
- Density (and sp grav) determinations 1 X;
 3 D64–D81
 of gases 3 D71
 of liquids 3 D67–D71
 of solids 3 D71–D80
- Density of blasting expls, controlling charge
 density, location of boreholes, density of
 charge in the borehole and stemming the charge
 3 D81–D83
- Density, bulk (of liquid rocket proplnts)
 3 D83–D84
- Density-detonation velocity relationship see
 Detonation and expln 4 D643
- Density of energy 3 D84
- Density of fragments (splinters) test 1 XII; 3 D84
- Density impulse 3 D84
- Density of loading of cast expls, increase of
 3 D84–D85
- Density values of some expls as determined by
 Stettbacher 3 D85
- Dentex 3 D85
- DEP or DEtPH see o-Diethylphthalate
 5 D1248–D1253
- Depot 3 D85
- Depot d'explosifs (Fr) 3 D85
- Depth charges and their expls 3 D85–D87
 cylindrical 3 D86
 projector missiles 3 D86–D87
 teardrops depth charge 3 D86
- Dermatitis and dermatosis in war industries
 3 D87–D88
- Derne mining association testing gallery see
 Coal mining expls 3 C371
- Dervish 3 D88
- Description of various types (classes) of Dynamites
 5 D1594–D1614
- Desensitization of expls; desensitizers and
 desensitized expls 3 D88–D90
- Desiccator test (hygroscopicity) 7 H251
- Designolle 3 D90
- Desintegrating bullets 3 D90
- Desmaroux stability (heat) test 3 D90
- Desorption 3 D90
- Desoxy 3 D90–D91
- 6-Desoxy-D-glucose 3 D91
 6-nitro-6-desoxy-D-glucose 3 D91
- 6-Desoxy-L-idose 3 D91
 6-nitro-6-desoxy-L-idose 3 D91
- Desoxyinositol and derivs 3 D91–D92
 mononitrodesoxyinositols 3 D91
 pentanitrodesoxyinositol 3 D92
- Destruction of ammo, expls, proplnts and pyrots
 3 D92
- Destructors of WWII 3 D92–D96
 the A-M3A1 3 D94
 the AN-M2 3 D93

- Destroctors of WWII (cont'd)
 the M-4 3 D94
 the M-5 3 D94
 the M-6 & M-7 3 D95
 the US universal M-10 3 D95, D96
- DETA see Bis (aminoethyl)-amine 3 D96
- "Detaclad" expln bonded clad metals 3 D96
- Detaclad process 3 D96-D97
- Detacord 3 D97
- Detaflex flexible cord expl 3 D97-D99
- Detasheet flexible sheet expls 3 D99-D101
- Detection of acidity in NC proplnts see Angeli
 test 1 A403
- Detectors see Chronographs 3 C306
- Detent and Detent lock 3 D101
- Detergency and detergents 3 D101-D102
- Determination of purity of inorganic compds of
 ordnance interest by titration in inorganic
 medium 3 D102
- Determination of AN by nitrometer method
 1 A376-A378
- Determination of heats of expln and detonation
 4 D377
- De Terré 3 D102
- Deterrents or moderants 3 D102
- Detonability and flammability of expls, proplnts
 and pyrot compns 4 D211
- Detonability of proplnts 3 D103
- Detonateur (Fr) 3 D103
- Detonateur secondaire (Fr) 3 D103
- Detonating cables see Bangalore torpedoes 2 B16
- Detonating capacity of expls, effect of various
 factors 4 D213
- Detonating caps, testing of 3 D103
- Detonating cord of Bofors, examination of 3 D103
- Detonating cords or fuses 3 D103-D104
- Detonating cords; US military requirements
 and testing 3 D104-D107
- Detonating cords (cont'd)
 material requirements 3 D105
 other requirements and tests 3 D105-D107
- Detonating corks 3 D107
- Detonating expls 3 D107
 HE's 3 D107
 LE's 3 D107
- Detonating fuses 3 D108
- Detonating ignition 3 D108
- Detonating red substances 3 D108
- Detonating relays 3 D108
- Detonation and expln 4 D217
- Detonation (and expln) autocatalytic 3 D225
- Detonation (and expln), break character of
 4 D226
- Detonation (and expln), breaking theory of Carl
 4 D227
- Detonation (and expln) by impact (or shock)
 4 D391
- Detonation (and explosion) by influence 1 X;
 4 D395-D402
 air-gap test 4 D397-D398
 booster-gap expl sensitivity test of Cole &
 Edwards 4 D398
 booster sensitivity test 4 D398
 card-gap sensitivity test of Cook et al 4 D398
 card test 4 D399
 coefficient de self-excitation 3 C390; 4 D399
 four cartridge test 4 D399
 gap tests 1 XIV; 4 D399
 halved-cartridge gap method 1 XIV; 4 D399
 shock-pass-heat-filter 3 D399
 three-legged table sensitivity test 4 D399
 wax gap test 1 VIII; 4 D399
 whole cartridge sensitivity test 4 D399
- Detonation (and expln) by priming and boosting
 4 D494
- Detonation (and expln), chain reactions in
 4 D229
- Detonation (and expln), craters in 4 D242
- Detonation (and expln) development (transition)
 from burning or deflagration 4 D245

- Detonation (and expln), distant effect of 4 D252
- Detonation (and expln); dusts, mists and vapors 4 D253
- Detonation (and expln), effects of blast and shock waves on structures 4 D256
- Detonation (and expln) effects produced in air, earth and water 4 D257
- Detonation (and expln), electrical, electromagnetic and magnetic effects accompanying it 4 D258
- Detonation (and expln), energy of 4 D264
- Detonation (and expln), energy relationships in 4 D266
- Detonation (and expln) energy (relative) release during Susan test (ignition of expls by impact) 4 D267
- Detonation (and expln), enthalpy, excess in 4 D267
- Detonation (and expln) equations of state 4 D268–D299
- Detonation (and expln) experimental procedures 4 D299
- Detonation (and expln), fugacity of products of 4 D351
- Detonation (and expln), hazards of 4 D366
- Detonation (and expln), ignition of expls and proplnts 4 D390
- Detonation (and expln), impetus and available energy 4 D393
- Detonation (and expln), impulse in 4 D393
- Detonation (and expln) impulse, specific 4 D394
- Detonation (and expln) in a medium of variable density 4 D441
- Detonation (and expln), induction period in initiation of expls and proplnts 4 D394
- Detonation (and expln) in gases 4 D351
- Detonation (and expln) in gases; determination of ignition points 4 D360
- Detonation (and expln) in gases, vapors and dusts; development (transition) from burning (combustion) or deflagration 4 D360
- Detonation (and expln), initiation (birth), and propagation in expl substances 4 D402–D417
- Detonation (and expln), initiation & shock processes, detonation head and detonation edge 4 D417
- Detonation (and expln) of composite expls 4 D237
- Detonation (and expln) of composite proplnts—theoretical treatment 4 D238
- Detonation (and expln) of condensed (liquid and solid) expls 4 D238
- Detonation (and expln) temp and its determination 4 D583–D589
- Detonation (and expln), temp developed on 4 D589f
- Detonation (and expln) theories 4 D601–D629
- Detonation (and expln), underwater 4 D628 see 10
- Detonation and expln velocity in gases 4 D663
- Detonation and expln waves 4 D676–D682
- Detonation (and expln), work capacity in 4 D730
- Detonation and expls phenomenon 4 D346
- Detonation and reaction waves, one-dimensional 4 D686
- Detonation and retonation, backward 4 D143
- Detonation, anomalous high velocity of 4 D139
- Detonation; attenuation, break, cessation, cutoff, decay, drying-out, extinction, fadeout and failure 4 D223
- Detonation; BMPT (Birkhoff-Macdougall-Pough-Taylor) theory of jet formation in shaped charges 4 D226
- Detonation, cavitational phenomenon 4 D167
- Detonation, Chapman-Jouguet (CJ) condition 4 D230
- Detonation, Chapman-Jouguet (and deflagration) 4 D230
- Detonation, Chapmen-Jouguet (in gas) 4 D230

- Detonation, Chapman-Jouguet isentrope 4 D230
- Detonation, Chapman-Jouguet parameters or variables 4 D230
- Detonation, Chapman-Jouguet point 4 D231
- Detonation, Chapman-Jouguet postulate or hypothesis 4 D231
- Detonation, Chapman-Jouguet pressure 4 D231
- Detonation, Chapman-Jouguet state 4 D235
- Detonation, Chapman-Jouguet theory 4 D235
- Detonation, Chapman-Jouguet wave and flow behind it 4 D236
- Detonation, characteristic direction 4 D169
- Detonation, charge parameters in 4 D170
- Detonation, classical theory of plane detonation wave 4 D237
- Detonation, contact transmission of 4 D187
- Detonation, critical energy of impact in 4 D198
- Detonation, critical length of propagation of 4 D199
- Detonation, curved front theory of Eyring et al 4 D242
- Detonation, deformation and break-up of solids by 4 D208
- Detonation, delayed-, after-, or post-reactions 4 D210
- Detonation developed in constricted tubes, super-compressed 4 D578
- Detonation, effect of replacement of air in expl charges by non-expl charges 4 D663
- Detonation, end effect in 4 D264
- Detonation (expln and deflagration) velocity 4 D629-D676
- Detonation, expln and expls, introduction and definitions 4 D217
- Detonation, factors influencing velocity and other properties of expls in 4 D347
- Detonation, failure of coal mining expls in a bore hole 4 D347
- Detonation, Fanno line 4 D348
- Detonation, flame reactions and 4 D348
- Detonation, flash-across, heat pulse and hyper-velocity phenomena 4 D348
- Detonation, free volume theory of the liquid state developed by Eyring et al and by Lennard-Jones-Devonshire 4 D349
- Detonation, free volume theory of multi-component fluid mixtures 4 D349
- Detonation front, non-planar 4 D349
- Detonation front, shock front, detonation zone and shock zone 4 D350
- Detonation, geometric model theory of 4 D363
- Detonation, heat sensitization of expls and memory effect 4 D367
- Detonation, high-, low- and intermediate order, velocities of 4 D384
- Detonation, hydrodynamic and hydrothermodynamic theories of 4 D610
- Detonation, ideal and non-ideal 4 D389
- Detonation, induced shock wave velocity in water & plexiglas by 4 D676
- Detonation in granular expls 4 D365
- Detonation, jetting in 4 D420
- Detonation, jumping 4 D421
- Detonation, lateral expansion and lateral loss in 4 D421
- Detonation, lateral shock pressure measured at an expl column 4 D423
- Detonation limit 4 D423
- Detonation limits in composite expls 4 D423
- Detonation limits in condensed expls 4 D423
- Detonation limits in high expls 4 D424
- Detonation, luminosity produced on 4 D424
- Detonation, mach no 4 D434
- Detonation, mach wave, mach reflection; triple point; and mach region 4 D434
- Detonation, maser and laser in 4 D436
- Detonation, mechanical effects in 4 D441

- Detonation, mechanism of 4 D441
- Detonation model of Von Neumann-Zel'dovich 4 D442
- Detonation, molecular theory of 4 D442
- Detonation, Munroe-Neumann effect and lined cavity effect in 4 D442
- Detonation, NDZ theory 4 D454
- Detonation, Neumann's pathological 4 D457
- Detonation, nonlinear theory of unstable one-dimensional 4 D460
- Detonation, nonreactive shock in 4 D460
- Detonation, nozzle theory or expanding jet theory of Jones 4 D460
- Detonation, nuclear 4 D461
- Detonation of cylindrical charges 4 D244
- Detonation of dense heterogeneous expls, transitional eventgs leading to 4 D245
- Detonation of expl mixtures 4 D246
- Detonation of large amounts of expls 4 D421
- Detonation, overboosting in 4 D462
- Detonation, parameters and characteristics of 4 D463
- Detonation, particle size effect in 4 D465
- Detonation, particle size effect on velocity of 4 D466
- Detonation, particle velocity determination in 4 D466
- Detonation, penetrating or jetpiercing theory of Apin 4 D467
- Detonation performance and its prediction 4 D470
- Detonation, perturbation theories of 4 D470
- Detonation, phenomena accompanying 4 D471
- Detonation, plasma in 4 D471
- Detonation, polytropic curve and polytropic law 4 D474
- Detonation, powdery expl charge 4 D475
- Detonation; power, available energy and strength in 4 D476
- Detonation, precursor shock in 4 D479
- Detonation, predetonation phase in 4 D482
- Detonation pressure-charge density relationship and temp of detonation-charge density relationship 4 D491
- Detonation pressure, experimental determination of 4 D485
- Detonation pressure measurements 1 X; 4 D483-D491
- Detonation processes; properties of expls affecting them 4 D494
- Detonation processes, transients and unstable 4 D624
- Detonation products 4 D494
- Detonation-product equation of state obtained from hydrodynamic data 4 D495
- Detonation progress thru a column of expl 4 D495
- Detonation propagation thru expl charges 4 D497
- Detonation propagation thru layers of non-expl substances between expl pellets 4 D498
- Detonation, pseudo 4 D499
- Detonation, pseudopotential theories of 4 D499
- Detonation, qual theory of 4 D499
- Detonation, rarefaction (or expln) wave and release wave of E.M. Pugh 4 D500
- Detonation rate determination 1 X; see Experimental determination of detonation velocity 4 D632-D640
- Detonation, Rayleigh (or Mikhel'son) line and transformation in 4 D502
- Detonation, reaction front in 4 D503
- Detonation, reaction mechanism 4 D503
- Detonation, reaction rate in 4 D504
- Detonation, reaction zone in 4 D505
- Detonation, reformation of 4 D506
- Detonation related subjects 4 D137ff
- Detonation, relaxation in 4 D507
- Detonation, resistance to 4 D508

- Detonation, retonation caused by the reflection of divergent waves in 4 D510
- Detonation, Schweikert theory of 4 D511
- Detonations, cylindrical 4 D203
- Detonation, sensitivity of expls to 4 D511
- Detonation sensitivity test, contact 4 D186
- Detonation; shock effect, front, impulse, pressure, wave and zone 4 D515
- Detonation, shock compressibility in 4 D517
- Detonation, shock Hugoniot in 4 D517
- Detonation, shock impedance and acoustic impedance in 4 D518
- Detonation, shock- or impact loading of metals 4 D518
- Detonation, shock pressure in and its measurement 4 D519
- Detonation, shock propagation in 4 D519
- Detonation, shock regime thermoelectric effect in 4 D520
- Detonation, shock sensitivity in 4 D520
- Detonation, shock transition to 4 D520
- Detonation, shock transmission from expl to metal plate 4 D521
- Detonation, shock tube technique studies in 4 D522
- Detonation, shock velocity in air and other substances 4 D529
- Detonation, shock wave in 4 D530
- Detonation, shock wave principal of similarity, its application and scaling effects in 4 D541
- Detonation, shock wave fracturing of metal or rock during 4 D542
- Detonation in slurry expls 4 D545
- Detonation, sound speed frozen in 4 D547
- Detonation in space 4 D548
- Detonation, spalling and scabbing of solid by shocks from 4 D548
- Detonation, spectra and spectrographic measurements in 4 D548
- Detonation, spherical 4 D549
- Detonation, spherical Taylor wave for the gaseous products of solid expls during 4 D554
- Detonation, spike pressure and spike theory of 4 D557
- Detonation, spontaneous 4 D561
- Detonation, stability and instability 4 D569
- Detonation, steady and nonsteady state 4 D575
- Detonation, strong and weak 4 D576
- Detonation, supersonic (or hypersonic) 4 D578
- Detonation, surface erosion model of Eyring et al as applied in 4 D581
- Detonation, TDBP wave 4 D582
- Detonation theories leading to development of hydrodynamic and hydrothermodynamic theories, history of 4 D602
- Detonation, thermal theories and thermochemistry of 4 D619
- Detonation, threshold ignition pressure in 4 D622
- Detonation, threshold velocities V_c (theoretical) for impact explns of massive targets in detonation 4 D623
- Detonation, transfer 4 D624
- Detonation, transition from shock to 4 D625
- Detonation, transition of 4 D627
- Detonation velocity and chemical compn and detonation velocity as a function of oxygen balance and heat of formation 4 D656
- Detonation velocity, anomalous high 4 D640
- Detonation velocity by direct visualization of the expl flow 4 D660
- Detonation velocity by metallic transition of sulfur 4 D672
- Detonation velocity, calculation of 4 D630

- Detonation velocity-charge density relationship
4 D643
- Detonation velocity-charge diameter and density relationships 4 D646
- Detonation velocity-charge diameter relationship
4 D641
- Detonation velocity-confinement and obturation relationship 4 D657
- Detonation velocity-critical and limiting diameter relationship 4 D660
- Detonation velocity, explt determination of
4 D630
- Detonation velocity, influence of inert components and inert additives 4 D667
- Detonation velocity, influence of magnetic, electro-magnetic and electrical fields as well as electrons 4 D668
- Detonation velocity, influence of method of initiation 4 D671
- Detonation velocity, influence on by the ageing of gelatin expls 4 D666
- Detonation velocity-particle size distribution relationship 4 D672
- Detonation velocity-pressure over expl relationship
4 D672
- Detonation velocity-temp (initial) of charge relationship 4 D674
- Detonation wave, annular 4 D139
- Detonation wave, cissoidal 4 D683
- Detonation wave, elastic 4 D648
- Detonation wave front 4 D684
- Detonation wave, laminar 4 D685
- Detonation, wave, plane 4 D689
- Detonation wave, plastic 4 D689
- Detonation wave, predetonation period in 4 D690
- Detonation wave, progress of 4 D690
- Detonation wave, propagation of 4 D691
- Detonation wave, radius of curvature of its front versus velocity 4 D692
- Detonation wave, shape and density properties
4 D693
- Detonation waves, oblique 4 D685
- Detonation waves of expl mixtures, course of reactions in the 4 D682
- Detonation waves, over-compressed and under-compressed 4 D686
- Detonation waves, parameters of 4 D689
- Detonation wave, spherical 4 D699
- Detonation waves, stationary, standing, or stabilized 4 D700
- Detonation wave, steady and non-steady 4 D703
- Detonation wave, steady flow in 4 D700
- Detonation waves, steady state; one-dimensional reaction waves with finite reaction rate
4 D703
- Detonation waves, steady-state; one-dimensional reaction waves with instantaneous reaction
4 D704
- Detonation wave, steady-state plane, one-dimensional 4 D708
- Detonation wave, steady state, three-dimensional, axially symmetric with finite reaction rate
4 D710
- Detonation waves, transients in propagation of
4 D118
- Detonation wave structure measurements in condensed expl 4 D715
- Detonation wave, structure of 4 D714
- Detonation wave study by a missile technique
4 D716
- Detonation wave study by spectrophotometric analysis 4 D716
- Detonation wave theories 4 D716
- Detonation wave, three-dimensional 4 D716
- Detonation wave, transient (one-dimensional)
4 D716
- Detonation wave, transient, three diemnsional
4 D723
- Detonation wave, two-dimensional 4 D724

- Detonative (and expl) combustion or expl deflagration 4 D731
- Detonative ignition of gases 4 D732
- Detonators and blasting caps, initiating efficiency 1 XI, XVIII
- Detonators, exploding bridgewire (EBW) 4 D807
- Detonators, igniters and primers used for initiating low expls in military ammo 4 D757ff
- Detonators, igniters and primers used for non-military purposes 4 D733–D737
- Detonators, igniters, primers and other initiating devices used for military purposes 4 D742–D757
- Detonators, military 4 D803–D807
- Detonators, nonmilitary 4 D737
- Detonators used for initiating demolition charges and land mines 4 D803
- Detoniruyushchii shnur 5 D1109
- Detonites 5 D1109
- Detoxication of wash waters containing DNT 5 D1109
- Detroit Arsenal 5 D1109
- Deuterium or "heavy hydrogen" 5 D1109
- Deuterium oxide or "heavy water" 5 D1109–D1110
- Deuterium peroxide 5 D1110
- Deutsche geschossfullung 5 D1110
- Devarda metal 5 D1110
- Devarda method of analysis 5 D1110
- Development of combustion and expln in liquids and solids 5 D1110
- Development of expln (or of deflagration, or of detonation) 5 D1110
- Device, arming (mechanical safety) 5 D1110
- Devices for blasting a pass through wire obstacle or through mine fields 5 D1110
- Devices, special for use in the Ordnance industry during WWII 5 D1110–D1113
- Devices, special for use in the Ordnance industry during WWII (cont'd)
- bangalore torpedoes and demolition hoses & snakes 5 D1113
 - expl pin 5 D1112–D1113
 - reddy fox or w snake 5 D1113
 - spoiler actuator 5 D1111
- Dextrin 5 D1113–D1115
- Dextrin nitrate 5 D1115
- Dextrose 5 D1116
- Dextrose pentanitrate 5 D1116
- Dextrose polymers and their nitrates 5 D1116
- DGO (proplnt) 5 D1116
- DGV or DDP (70) 5 D1116
- DI (Ger) 5 D1117
- Di 5 D1117
- Diacetato-plumbo complexes 5 D1117
- Diacetin see Acetins 1 A31
- Diacetone (alcohol) 5 D1117
- Diacetone diperoxide 1 A41–A42
- Diacetophenone diperoxide see Acetophenone 1 A48
- Diacetotetrazacyclooctane 5 D1118
- 1,5-diaceto-3,7-dinitro-1,3,5,7-tetrazacyclooctane 5 D1118
- 1-9-Diacetoxy-2-(4) acetyl-4-(2-) 6,8-trinitro-2,4,6,8-tetrazanonane see 2-(4) Acetyl-1,9-diacetoxy-4-(2-) 6,8-trinitro-2,4,6,8-tetrazanonane 1 A57
- Diacetoxy-diazapentane 5 D1118
- 1,5-diacetoxy-2,4-dinitro-2,4-diazapentane 5 D1118
- Diacetoxy-tetrazanonane 5 D1118–D1119
- 1,9-diacetoxy-2,4,6,8-tetranitro-2,4,6,8-tetrazanonane 5 D1118
- Diacetoxytriazheptane 5 D1119
- 1,7-diacetoxy-2,4,6-trinitro-2,4,6-triazheptane (BSX) 5 D1119
- Dinitroxy-BSX or 1,7-dinitroxy-2,4,6-trinitro-2,4,6-triazheptane 5 D1119
- Diacetylamino-pentetrol 5 D1119–D1120

- Diacetylaminophenol 5 D1120
 X-tetranitrodiaetylaminophenol 3 D1120
- Diacetylene 5 D1120
- Diacetylenedicarbonic acid 5 D1120
- Diacetylenic dihydroperoxides 5 D1120—D1121
 7,7'-dicyclohexyl-7,7'-butadiene-6,6'-dihydroperoxide 5 D1120
 3,8-dimethyl-4,6-decadiyn-3,8-dihydroperoxide 5 D1120—D1121
 2,7-dimethyl-3,5-octadiyn-2,7-dihydroperoxide 5 D1121
 2,4-hexadiyn-1,6-dihydroperoxide 5 D1121
- Diacetyl-orthonitric acid 5 D1121
 diargentate acetonitrate 5 D1121
- Diacetyl peroxide or acetyl peroxide 5 D1121—D1122
- Dialkylacetylenes 5 D1122
- Dialkyliminotetrazoles 5 D1122
 1,3- (or 1,4) dimethyl-5-iminotetrazole 5 D1122
- Dialkylphthalates, determination in NG proplnts 5 D1122—D1123
- N¹, N⁴-Dialkyl-triethylenetetranitramines 5 D1123
- Diallybenzidine and derivs 5 D1123
 N,N'-diallyl-N,N',3,5,3',5'-hexanitrobenzidine 5 D1123
 N,N'-diallyl-3,5,3',5'-tetranitrobenzidine 5 D1123
- Diallylether or allyl ether 5 D1123
- Diallylpentaerythritol ether 5 D1123
- Diallylphosphite 5 D1124
- Diallyl-o-phthalate 5 D1124
- Dialysis, electrolysis and electro dialysis 5 D1124
- Diameters, limiting (of expls) 5 D1124—D1125
- Diamide powder no 1 5 D1125
- Diamides 5 D1125
 polynitrodiamides 5 D1125
- Diamidides 5 D1125
- Diamines 5 D1126
 , aliphatic 5 D1126
 , aromatic 5 D1126
 , nitro 5 D1126
- Diamino-1-alkenes 5 D1126
- 5,7-Diamino-3-amyl (or 3-pentyl)-s-triazolo-[4,3-*a*]-s-triazine 5 D1126
- Diaminoanisole and derivs 5 D1127
 dinitrodiaminoanisoles 5 D1127
 mononitrodiaminoanisole 5 D1127
- Diaminoanthraquinone and derivs 5 D1127—D1128
 dinitrodiaminoanthraquinones 5 D1127—D1128
 tetranitrodiaminoanthraquinones 5 D1128
 2,4,6,8-tetranitro-1,5-dinitraminoanthraquinone 5 D1128
- Diaminoazobenzene and derivs 5 D1128—D1129
 dinitrodiaminoazobenzene 5 D1129
 mononitrodiaminoazobenzenes 5 D1128—D1129
- Diaminoazoxybenzene see Azoxyaniline 1 A665
- Diaminobenzene and derivs 5 D1129—D1131
 1,2-diaminobenzene perchlorate 5 D1129
 1,3-dinitraminobenzene 5 D1130
 dinitrodiaminobenzenes 5 D1130
 1,4-dinitrosodihydroxylaminobenzene 5 D1130
 mononitrodiaminobenzenes 5 D1129—D1130
 tetranitrodiaminobenzene 5 D1131
 2,4,6-trinitro-1,3-diaminobenzene (DATB or DATNB) 5 D1130—D1131
- Diaminobenzil and derivs 5 D1131
 3,3',5,5'-tetranitro-4,4'-diaminobenzile 5 D1131
- 4,6-Diaminobenzimidazole 5 D1132
- Diaminobenzofurazan 5 D1132
- Diaminobenzophenone and derivs 5 D1132—D1133
 3,3'-dinitro-4,4'-diaminobenzophenone 5 D1132
 3,5,3',5'-tetranitro-4,4'-diaminobenzophenone 5 D1132—D1133
- 4,4-Diaminobiphenyl see Benzidine 2 B63
- Diaminobiphenyl, nitrated derivs 5 D1133—D1134
 dinitrodiaminobiphenyls 5 D1133

- Diaminobiphenyl, nitrated derivs (cont'd)
 2,4,2',4',6',6'-hexanitro-3,3'-diaminobiphenyl
 5 D1133–D1134
 4,6,4',6'-tetranitro-3,3'-diaminobiphenyl
 5 D1133
- 1(5-Diaminobiuret) 5 D1134
- Diaminobutane and derivs 5 D1134
 dinitroaminobutanes 5 D1134
- Diaminodihydro-s-tetrazine and derivs 5 D1135
 3,6-diamino-3,6-dihydro-s-tetrazine dinitrate
 5 D1135
- Diaminodimethylamine 5 D1135
 1,1'-dinitramino-N-nitrodimethylamine
 5 D1135
- Diaminodimethylanthraquinone 5 D1135
- Diaminodimethylbenzene and derivs 5 D1136
 mononitrodiaminodimethylbenzenes 5 D1136
- 1,3-Diamino-1,2-dimethylpropane diperchlorate
 5 D1136
- Diaminoethane and derivs 5 D1136–D1138
 diaminoethane dichlorate 5 D1138
 di (aminoethyl)-amine 2 B128
 N,N'-di-(β -aminoethylamino)-ethane 2 B129
 diaminoethylene dichlorate 5 D1138
 N,N'-di-(β -aminoethyl)-ethylenediamine
 (TETA) 2 B129
 N,N'-dinitro-diaminoethane (EDNA and
 HALEITE) 5 D1137–D1138
 N-nitro-diaminoethane 5 D1137
- sym-Di-(aminoethyl)-urea see 1,3-Bis (1-amino-
 ethyl)-urea 2 B130
- N,N'-Di-(β -aminoethyl)-propanediamine see Bis
 (aminoethylamino)-propane 2 B130
- 1,3-Diaminoguanidine 5 D1138
- Diaminoguanidine azide 5 D1138
- Di-(aminoguanidinium)-1,6-dinitro-2-(amino-
 guanyl)-biguanidine see Bis-(aminoguanidinium)-
 1,6-dinitro-2-(aminoguanyl)-biguanidine
 1 A214
- Di(aminoguanidinium)-1,6-dinitrobiguanidine see
 Bis (aminoguanidinium)-1,6-dinitroguanidine
 1 A214
- Diaminohydroxytriazine picrate see Ammeline
 picrate 1 A274
- Diaminoimidazolidine 5 D1138–D1139
 (2-amino-2-nitramino-1-nitro)-imidazolidine
 5 D1138
- Diaminomethane and derivs 5 D1139–D1140
 N,N'-dinitrodiaminomethane 5 D1139–D1140
- Di-(aminomethyl)-propanediamine and derivs
 5 D1140 see Bis (aminomethyl)-propanediamine
 2 B130
 2,2-Di-(nitraminomethyl)-1,3-propanedinitra-
 mine 5 D1140
- 2,4-Diamino-6-methyl-s-triazine 5 D1140–D1141
- Diamino-oxalic acid dihydrazide 5 D1141
- Diaminophenol and derivs 5 D1141–D1142
 mononitrodiaminophenol 5 D1141–D1142
 2,4,6-trinitro-3,5-diaminophenol 5 D1142
- Diaminopropane and derivs 5 D1142–D1143
 1,2-dinitraminopropanes 5 D1142–D1143
 N,N'-dinitro-N-methylethylenediamine 5 D1143
 mononitrodiaminopropane 5 D1142
- Diaminopropanol and derivs 5 D1143–D1144
 1,3-dinitramino-2-propanol nitrate
 5 D1143–D1144
- Diaminotetramethylbenzene and derivs 5 D1144
 dinitrodiaminotetramethylbenzenes 5 D1144
 mononitrodiaminotetramethylbenzenes
 5 D1144
- 3,6-Diamino-sym-tetrazine 5 D1145
- Diaminothiadiazole and derivs 5 D1145
 5-nitrosoamino-2-amino-1,3,4-thiadiazole
 5 D1145
- Diaminotoluene and derivs 5 D1145–D1146
 dinitro-diaminotoluenes 5 D1146
 mononitrodiaminotoluenes 5 D1146
 2,4,6-trinitro-3,5-diaminotoluene 5 D1146
- 2,4-Diamino-s-triazine 5 D1146–D1147
- 4,6-Diamino-s-triazine-2-carbamionitrile 5 D1147
- 4,6-Diamino-s-triazine-2-ol see Ammeline 1 A273
- (4,6-Diamino-s-triazine-2-yl)-guanidine
 5 D1147–D1148

- Diaminotriazole and derivs 5 D1148–D1149
 5-azido-3-nitrosamino-1,2,4-triazole 5 D1149
 3,5-dinitramino- α -triazole salts 5 D1149
 3,5-dinitrosamino- γ -s-triazole 5 D1149
 mononitramino-aminotriazole 5 D1149
 mononitroso-3,5-diamino- α -s-triazole 5 D1148
 5-nitrosamino-3-amino- γ -s-triazole 5 D1148
- Diammine-cadmium-nitrate see Ammines 1 A277
- Diammine-copper-nitrate 1 A280
- Diammine-manganese-fulminate 1 A281
- Diammine-zinc-fulminate 1 A281
- Diammine-zinc-nitrate 1 A281
- Diamond Ordnance Fuze Labs (DOFL) 5 D1149
- Diamylamine perchlorate 5 D1149–D1150
- Diamylether see Amylether 1 A396
- α -Diamylose and its hexanitrate and tetranitrate
 5 D1150
- Diamylphthalate and di-isoamylphthalate
 5 D1150–D1151
- Dianilino-anthraquinone see Bis (anilino)-anthra-
 quinone 2 B130
- Dianilino-azobenzene see Bis (anilino)-azobenzene
 2 B131
- α - β -Dianilino-ethane see 1,2-Bis (N-anilino)-
 ethane 1 B131
- N,N'-Di-(4-anilinophenyl)-urea see N,N'-Bis
 (4-anilinophenyl)-urea 2 B132
- α , γ -Dianilino-propane see 1,3-Bis (anilino)-
 propane 2 B132
- Dianisole and derivs 5 D1151–D1152
 dinitrodianisoles 5 D1151–D1152
 tetranitrodianisoles 5 D1152
- Dianisoyl peroxide 5 D1152–D1153
- Diargentic acetonitrate 5 D1121
- Diaryl phthalates in proplnts 5 D1153
- Diaspon expl 5 D1153
- Diaspon gelatin 5 D1153
- Diatomaceous earth see "Celite" 2 C93
- Diaza 5 D1153
- Diaza alkanes, polynitro 5 D1153
- 1,3-Diazacyclopentane see Cyclo-2,4,5-trimethyl-
 ene-1,3-diamine 3 C610
- 4,7-Diazadecane-2,2,7,9,9-hexanitro 5 D1154
- 3,5-Diazaheptane; 1,1,1,3,5,7,7,7-octanitro
 5 D1154
- 1,3-Diazapentane see Cyclo-2,4,5-trimethylene-
 1,3-diamine 3 C610
- Diazido 5 D1154
- α , δ -Diazidoadipic acid 5 D1154
- 2,6-Diazidoanthraquinone 1 A460
- 3,3'-Diazidoazoxy benzene 1 A666
- Diazido-benzene 2 B42
- Diazidobenzoic acid 2 B69
- Di-(α -azidobenzylidene)-azine see Bis (α -azido-
 benzylidene)-azine 2 B133
- Di-(α -azidobenzylidene)-hydrazine see Bis
 (α -azidobenzylidene hydrazine 2 B133
- Diazidobiphenyl 2 B123
- Diazidobiphenyldicarboxylic acid 2 B125
- Diazidochloropropane 3 C264
- Diazido compds 5 D1155
- 2,5-Diazido-3,6-dichloro-1,4-benzoquinone 2 B80
- 1,3-Diazido-4,6-dinitrobenzene 2 B43
- α , α -Diazidodiphenylmethane 5 D1464
- 4,4'-Diazidodiphenylsulfone 5 D1479
- Diazidotetrammine complexes see Ammines
 1 A278–A279
- Di-(azidothioformyl)-disulfide see Bis (azidothio-
 formyl)-disulfide 2 B133
- 2,6-Diazido-4-trimethylammonium-1,4-benzoqui-
 none 2 B84–B85
- 1,3-Diazido-2,4,6-trinitrobenzene 2 B43
- Diazo 5 D1155
- Diazoacetamide 5 D1155
- Diazoacetic acid 5 D1155
- Diazoacetic acid, ethyl ester 5 D1155–D1156

- Diazoacetic acid, methyl ester **5 D1156**
- Diazoacetone **5 D1156**
- Diazoacetonitrile **5 D1156**
- Diazoaminobenzene and derivs **5 D1156–D1157**
 diazoaminobenzene, amine of **1 A195**
 dinitrodiazoaminobenzenes **5 D1156–D1157**
 mononitrodiazoaminobenzenes **5 D1156**
- 6-Diazo-3-aminobenzoic acid **5 D1157**
- 4-Diazoaminobiphenyl see I, III-Bis (p-biphenyl)-
 triazene **2 B136**
- Diazoamino compds **5 D1157**
- Diazoaminocresol and derivs **1 A194; 5 D1157**
- 5,5'-Diazoaminobistetrazole **5 D1157**
- Diazoaminonaphthalene **5 D1158**
- Diazoaminonaphthalene bromide hydrobromide
 see Amino-diazonaphthalene bromide hydro-
 bromide **1 A195**
- 4'-Diazoazobenzene-4-sulfonic acid **5 D1158**
- Diazobenzene and diazonium benzene derivs
2 B54–B58
- Diazobenzene hydrate see Benzenediazonium
 hydroxide **2 B55**
- Diazobenzeneimide **5 D1158**
- Diazobenzene nitrate see Benzenediazonium
 nitrate **2 B56**
- Diazobenzene oxalate see Benzenediazonium
 oxalate **2 B56**
- Diazobenzene perchlorate see Benzenediazonium
 perchlorate **2 B56**
- Diazobenzene picrate see Benzenediazonium
 picrate **2 B57**
- Diazobenzene sulfate see Benzenediazonium
 sulfate **2 B57**
- Diazobenzene sulfocyanate see Benzene-
 diazonium sulfocyanate **2 B57**
- Diazobenzene sulfonic acid see Benzene-
 diazonium sulfonic acid **2 B57**
- Diazobenzene tetrachloroiodide see
 Benzenediazonium tetrachloroiodide **2 B57**
- Diazobenzene tribromide see Benzenediazonium
 tribromide **2 B58**
- Diazobenzene trinitromethane see Benzene-
 diazonium salt of trinitromethane **2 B58**
- Diazobiphenyl perchlorate see Biphenyldiazonium
 perchlorate **1 A191**
- 2-Diazo-3-bromo-o-benzoquinone **2 B310**
- Diazobromochlorobenzoquinone **3 C253**
- 3-Diazobutan-2-one **2 B374**
- 1-Diazobutane **2 B367**
- Diazocamphor **2 C23**
- 3-Diazocarbazole **2 C47**
- Diazochemistry **5 D1159**
- Diazochloronitrophenol see Mononitrodiazo-
 chlorobenzoquinone under chlorobenzo-
 quinone and deriv **3 C253**
- Diazocompds **5 D1159**
- Diazocyclobutane see Cyclodiazocompds
3 C593
- Diazocycloethane see Cyclodiazocompds
3 C593
- 4-Diazo-2,5-cyclohexadien-1-one **5 D1159**
- Diazocyclohexane see Cyclodiazocompds
3 C593
- Diazocyclopentadiene **5 D1160**
- Diazocymol **5 D1160**
 nitro-p-cymol-2-diazonium nitrates **5 D1160**
- Diazodinitrophenol (DADNPh) see Dinitro-
 benzenediazooxide **2 B59; 5 D1160–D1163**
 , analytical procedures **5 D1160–D1163**
- 2,2'-Diazo-3,3'-dioxy-4,6,4',6'-tetranitro-m,m'-
 biphenol **2 B122**
- Diazodiphenylamine and derivs **5 D1163**
 4-diazo-2,4-dinitrodiphenylamine **5 D1163**
 4-diazo-2',4',6'-trinitrodiphenylamine **5 D1163**
 mononitrodiazodiphenylamine **5 D1163**
- Diazoethane **5 D1163**
- Diazoethoxane **5 D1163**
- 1-Diazoethylbenzene of methylphenyl-
 diazomethane **5 D1163–D1164**

- Diazoguanidine cyanide see Cyanoazoguanidine
3 C587
- Diazoguanidine picrate 5 D1164
- Diazoguanylazide 5 D1164
- Diazohydrocarbons 5 D1164
- Diazohydrazides 5 D1164
- 5-Diazo-2-hydroxybenzoic acid 5 D1165
- 6-Diazo-3-hydroxybenzoic acid 5 D1165
- Diazoimide see Hydrazoic acid 1 A537
- Diazoimide of benzenesulfonyltolylene see
Benzenesulfonyltolylenediazoimide 2 B62
- Diazoimide of benzenesulfonylxylylene see
Benzenesulfonylxylylenediazoimide 2 B63
- Diazol 5 D1165
- 1,2-Diazole and derivs 5 D1165
4-nitro-1,2-diazole 5 D1165
- 1,3-Diazole and derivs 5 D1165–D1166
- 5-Diazo-3-isopropyl-*asym* (1,2,4)-triazole
chloraurate 5 D1173
- Diazomethane 5 D1166
- iso-Diazomethane 5 D1166
- Diazomethanesulfonic acid 5 D1166
- 4-Diazo-1-[6-methyl-2-benzthiazolyl]-benzene
and salts 5 D1167
- 6-Diazo-2-methyl-4-nitro-2,4-cyclohexadiene-
1-one 5 D1167
- 6-Diazo-5-methyl-2-nitro-2,4-cyclohexadiene
5 D1167
- Diazonaphthalene and derivs 5 D1167–D1168
2 (or beta)-diazonaphthalene 5 D1167–D1168
iso-diazonaphthalene 5 D1168
mononitrodiazonaphthalene 5 D1168
- Diazonaphthol and derivs 5 D1168–D1170
diazonaphthol-carboxylic acids
5 D1169–D1170
dinitrodiazonaphthols 5 D1169
mononitrodiazonaphthol 5 D1168–D1169
- 1-Diazo-3-nitrobenzene perchlorate see *m*-Nitro-
benzenediazonium perchlorate 2 B56
- Diazonium chloride of aminodicarboxybiphenyl
see Aminodicarboxybiphenyl diazonium
chloride 1 A195
- Diazonium compds and sodium sulfide 5 D1170
- Diazonium derivs of anilinobenzene see
Anilinobenzene diazonium hydroxide and
derivs 1 A421
- Diazonium derivs of azobenzene see
Azobenzenediazonium derivs 1 A650
- Diazonium derivs of benzaminobenzene see
Benzanilidediazonium derivs 2 B41
- Diazonium derivs of benzanilide 2 B41
- Diazonium derivs of benzoquinone 2 B81
- Diazonium fluoroborates 5 D1170
3-pyridyldiazonium fluoroborate 5 D1170
- Diazonium hydroxide of aminobenzene see
Aminobenzene diazonium hydroxide 1 A187
- Diazonium salts 5 D1171
diazonium chromates & persulfates 5 D1171
diazonium nitrates 5 D1171
diazonium perchlorates & picrates 5 D1171
- Diazo oxide of benzene see Benzenediazo oxide
2 B58
- Diazo oxides 5 D1171
- 2-Diazo-3-oxidobenzoic acid, 4-nitro deriv
5 D1171
- Diazophenol and derivs 5 D1172
diazophenol and hydrazine reaction products
5 D1172
2-diazophenol-6-diazonium chloride, 4-nitro
deriv 5 D1172
dinitrodiazophenols 5 D1172
mononitrodiazophenols 5 D1172
2,3,6-trinitro-4-diazophenol see 2,3,6-trinitro-
benzene-4-diazo-1-oxide 2 B60
- 5 (or 3)-Diazo-3- (or 5)-phenyl-1,2,4-triazole
5 D1172
- Diazopropane 5 D1172–D1173
- Diazopropene 5 D1173
- Diazopyrocatechol and derivs 5 D1173
6-nitro-4-diazopyrocatechol 5 D1173
5-nitro-3-diazopyrocatechol-1-methyl ether
5 D1173

- 3-Diazo-4-(3H)-quinolone 5 D1173–D1174
- Diazoresorcinol and derivs 5 D1174–D1175
 dinitrodiazoresorcinols 5 D1174
 dinitrodiazoresorcinol methyl ethers
 5 D1174–D1175
 4-nitro-5-bromo-2-diazoresorcinol-1-methyl
 ether 5 D1174
 6-nitro-4-diazoresorcinol-3-methyl ether
 5 D1174
 4-nitroso-2-diazoresorcinol 5 D1174
- Diazosalicylic acid and derivs 5 D1175
 3-chloro-5-diazosalicylic acid 5 D1175
 3-chloro-5-diazosalicylic acid 5 D1175
 3-diazo-5-nitro-salicylic acid 5 D1175
- Diazostilbene and derivs 5 D1175
 nitrostilbene-diazonium-hydroxides 5 D1175
- Diazosulfide 5 D1175
- Diazotate 5 D1175
- 5-Diazotetrazole 5 D1176
- Diazotetrazole-aminoguanidine 5 D1176
- Diazotetrazole-benzylidene-aminoguanidine
 5 D1176
- Diazotetrazole-phenylhydrazine see N¹-Amino-N²-
 phenyl-N³-(tetrazolyl-5)-triazene 1 A147
- Diazotetrazole-semicarbazide 5 D1177
- Diazotization 5 D1177
- Diazotoluene and derivs 5 D1177–D1179
 m- (or p-) diazonitrotoluene salts 5 D1178
 o- (or 2-) diazotoluene salts 5 D1177–D1178
 dinitrodiazotoluenes 5 D1179
 mononitrodiazotoluene salts 5 D1178
 mononitroisodiazotoluenes and their salts
 5 D1178
- Diazotoluenesulfonic acid and derivs
 5 D1179–D1180
 eso-dinitrodiazotoluene sulfonic acids
 5 D1179–D1180
 mononitrodiazotoluene sulfonic acids 5 D1179
- Diazotoluenesulfonic acid halogenated derivs
 5 D1180
 bromodiazotoluene sulfonic acids 5 D1180
 3,5-dibromo-2-diazotoluene sulfonic acids
 5 D1180
- 5-Diazo-1,2,4-triazole-3-carboxylic acid 5 D1180
- Diazotrinitrophenol see Trinitrobenzene
 diazooxide 2 B60
- Diazouracil and derivs 5 D1180–D1181
 5-diazouracil-4-carboxylic acid 5 D1181
 5-diazouracil ethyl ether 5 D1181
 5-diazo-4-isonitrosomethyl-uracil 5 D1180
- Diazoxylyene and derivs 5 D1181
 diazoxylyene salts 5 D1181
 3,5-dichloro-2-diazo-p-xylylene salts 5 D1181
 3,5-dinitro-2-diazo-p-xylylene salts 5 D1181
- Diazoxylyene sulfonic acid and derivs
 5 D1181–D1182
 mononitrodiazoxylyene sulfonic acids 5 D1182
- Dibasic diethyl lead styphnate 5 D1182
- Dibenzalazobisaminoforamidine 5 D1182
- Dibenzaldehydrazine see Benzaldehydrazine and
 derivs 2 B35–B36
- Dibenzal-1,6-diaminobiguanidine 5 D1182
- Dibenzal diperoxide 5 D1182
- Dibenzalhydrazine see Benzaldehydrazine 2 B35
- Di-(benzeneazo)-azobenzene see Bis (benzeneazo)-
 azobenzene 2 B134
- Di-(benzeneazo)-azoxybenzene see Bis (benzene-
 azo)-azoxybenzene 2 B134
- Di-(benzeneazoxy)-azoxybenzene see Bis
 (benzeneazoxy)-azoxybenzene 2 B134
- Di-(benzenediazo)-glycocoll see (phenylazo)-
 glycine 2 B153
- Dibenzhydrazid (Ger) see Bis (α -azidobenzyl-
 idene)-azine 2 B133
- Dibenzoat des peroxyd XX 2 B136
- Dibenzofuran and derivs 5 D1183–D1184
 2,7-dinitrobenzofuran 5 D1183
 mononitrodibenzofuran 5 D1183
 2,3,7,8-tetranitrodibenzofuran
 5 D1183–D1184
 1,3,7,9-tetranitrodibenzofuran 5 D1184
 trinitrodibenzofurans 5 D1183
- Dibenzosulfonyl peroxide see Benzenesulfonyl
 peroxide 2 B62

- 1,1'-Di-(benzoperoxy)-cyclohexane see 1,1'-Bis (benzoylperoxycyclohexane) 2 B135
- 9,9'-Di-(benzoperoxy)-fluorene see 9,9'-Bis (benzoylperoxyfluorene) 2 B135
- 9,9'-Di-(benzoperoxy) 9,9'-fluorene-peroxide see 9,9'-Bis (benzoyl-peroxy fluorenyl)-peroxide 2 B136
- Dibenzophenone peroxider dimer 5 D1184
- Dibenzotetrazapentalene (TACOT) and derivs 5 D1184–D1185; 9 T1–T2
- Dibenzoyl and derivs 5 D1185
 4,5-dibenzoyl-1,2-dioxa-3,6-diazine 5 D1185
 dibenzoyl peroxide 5 D1886–D1188
 dibenzoyl nitrated derivs 2 B64–B65
- 3,4-Dibenzoylfurazan 5 D1185–D1186
- Dibenzoylfuroxan and derivs 5 D1186
 3,4-di-(p-nitro-benzoyl)-furoxan 5 D1186
- Dibenzoyl-hydrazine see Bis (benzoyl)-hydrazine 2 B134
- Dibenzoyl peroxide and derivs 5 D1186–D1188
 dibenzoyl peroxide analysis 5 D1187
 (dibenzoylperoxy)-cyclohexane see Bis (benzoylperoxy)-cyclohexane 2 B135
 di-(benzoylperoxy)-dicyclohexylperoxide see Bis (benzoylperoxy)-dicyclohexylperoxide 2 B135
 di-(benzoylperoxy)-dimethylhexane see Bis (benzoylperoxy)-dimethylhexane 2 B135
 di-(benzoylperoxyfluorenyl)-peroxide see Bis (benzoylperoxy)-fluorene 2 B135
 di-(benzoylperoxyfluorenyl)-peroxide see Bis (benzoylperoxyfluorenyl)-peroxide 2 B136
 dinitrodibenzoyl peroxide 5 D1187–D1188
 3,5,3',5'-tetranitrodibenzoyl peroxide 5 D1188
- 3,6-Dibenzoyl-1,2,4,5-tetraketo-4,5-dihydro-pyridazine 5 D1188
- Dibenzyl see Bibenzyl 2 B110
- Dibenzylamine and derivs 5 D1188–D1189
 dinitrodibenzylamines 5 D1189
 2-nitrodibenzylamine 5 D1188
 2,6,2',6'-tetranitrodibenzylamine 5 D1189
- ω,ω' -Dibenzylidene-diaminoguanidine see Bis (benzylideneamino)-guanidine 2 B136
- Dibenzylmethane and derivs 5 D1189–D1190
 dinitrodibenzylmethanes 5 D1189
 nitroso-nitro-dibenzylmethane 5 D1189
 X,X,X,X-tetranitrodibenzylmethane 5 D1190
- Di-(p-biphenyl)-amine see Bis (p-biphenyl)-amine 2 B136
- Diborane 5 D1190
- Di-(bornylamino) diazido-copper 5 D1190
- Dibromoacetylene 5 D1190
- Dibromoanilino-ethane see Bis (bromoanilino)-ethane 2 B136
- Dibromoanilino-propane see Bis (bromoanilino)-propane 2 B136
- Dibromobenzene and derivs 5 D1190–D1192
 1-azido-2,3- (or m)-dibromobenzene 5 D1191
 dinitrodibromobenzenes 5 D1191–D1192
 mononitrodibromobenzene 5 D1191
 1,3,5-trinitro-2,4-dibromobenzene 5 D1192
- 2,6-Dibrom-1,4-benzoquinone-4-oxime 2 B86
- Dibromodiaminoanthraquinone and derivs 5 D1192–D1193
 4,8-dinitro-2,6-dibromo-1,5-diaminoanthraquinone 5 D1192
 4,8-dinitro-2,6-dibromo-1,5-dinitraminoanthraquinone 5 D1192
- Dibromodiazophenol and derivs 5 D1193
 2-nitro-3,5-dibromo-4-diazophenol 5 D1193
- 3,5-Dibromo-2-diazotoluene-4-sulfonic acid 5 D1180
- 3,5-Dibromo-4-diazotoluene 5 D1193
- Dibromoethylsulfide see Chemical agents 2 C169
- Dibromofumaric acid 5 D1193
- 1,4-Di-(bromoimino)-p-quinone see Benzoquinone-1,4-di (dibromoimine) 2 B83
- Dibromopentaerythritol 5 D1194
- Dibromophenol and derivs 5 D1194–D1195
 2-azido-4,6-dibromophenol 5 D1194
 3,5-dibromophenol-4-diazonium hydroxide 5 D1195
 dinitrodibromophenol 5 D1195
 mononitrodibromophenol 5 D1194
 4-nitroso-2,6-dibromophenol 5 D1194
 2,4,6-trinitro-3,5-dibromophenol 5 D1195

- Dibromophenylamine and derivs 5 D1195–D1196
 dibromonitrophenylnitramines
 5 D1195–D1196
- 2,6-Dibromoquinonechlorimide 5 D1196
- Dibromoxylene see Chemical agents 2 C169
- Di(butylamino) diazo- and triazo-copper compds
 5 D1196
 di-(n-butylamino) diazo-copper 5 D1196
 di-(iso-butylamino) diazo-copper 5 D1196
 di-(iso-butylammonium)-triazole-copper 5 D1196
 3,5,3',5',N,N'-hexanitro-N,N'-diisobutylbenzidine 5 D1196
 3,5,3',5'-tetranitro-N,N'-diisobutylbenzidine
 5 D1196
- N,N'-Dibutylcarbanilide see Centralite, butyl
 2 C140
- Dibutyldiphenylurea see Centralite, butyl 2 C140
- Dibutyl magnesium 5 D1197
- Di-t-butyl peroxide 5 D1197
- Dibutylperoxy-butane see 2,2-Bis (t-butylperoxy)-
 butane 2 B137
- Dibutylperoxy-propane see 2,2-Bis (t-butylperoxy)-
 propane 2 B137
- Dibutyl-o-phthalate (DBP or DBuPh)
 5 D1197–D1199
 , analytical procedures 5 D1198–D1199
- Dibutylsebacate 5 D1199–D1200
- Dibutyltartrate 5 D1200
- Dibutylurea and derivs 5 D1200
 di (1,1,1-trinitro-isobutyl)-urea 5 D1200
- Di-n-butyl peroxide 5 D1200–D1201
- Dicadmium-acetato-perchlorate-acetate 5 D1201
- Dicamphoryl peroxide 5 D1201
- Di-n-caproyl peroxide 5 D1201
- Dicarbamylamine see Biuret 2 B164
- N,N'-Carboethoxy-1,3-diamino-isopropanol
 5 D1201
- Dicarboethoxyethylenediamine and derivs 5 D1201–
 D1202
 N,N-dinitro-N,N'-dicarboethoxy-ethylene-
 diamine 5 D1202
- 4,7-Dicarboethoxy-1,4,7,10-tetrazadecane see
 Bis (aminoethyl)-ethane-diurethane 2 B129
- Dicarbomethoxyethylenediamine and derivs
 5 D1202
 N,N'-dinitro-N,N'-dicarbomethoxyethylene-
 diamine 5 D1202
- Dicarboxamide-acetylene see Acetylene-
 dicarboxamide 1 A65
- Dicarboxanilide-acetylene 5 D1202
 N,N'-di-(2,4,6-trinitrophenyl) acetylene-
 dicarboxamide 5 D1202
- Dicarboxylic acid halogen amides, their salts and
 use in crosslinking of cellulose fibers thru
 urethane formation 5 D1202
- Dicarboxy-phenazine-N-oxide 5 D1202–D1203
 1,9-dicarboxy-2,4,6,8-tetranitrophenazine-N-
 oxide 5 D1202–D1203
- α,α -Dicarboxypimelyl tetraazide 5 D1203
- Dicarboxypropionyl-peroxide see Bis (succinyl)-
 peroxide 2 B156
- Dichloralperoxyhydrat (Ger) see Bis (α -hydroxy-
 β,β,β -trichlorethyl)-peroxide 2 B148
- 1,1-Dichloramine-5-(o-chlorophenyl)- α -tetrazole
 5 D1203
- 1,1-Dichloramino-5-phenyl- α -tetrazole 5 D1203
- 1,1-(N-Dichloramino)-5-(p-tolyl)- α -tetrazole
 1 A266
- Dichloroacetylene 5 D1203
- Dichloroacetyl peroxide 5 D1204
- N,N-Dichloroalkylamines 5 D1204
- 1,1-(N-Dichloramino)-5-(p-tolyl)- α (or 1H)-
 tetrazole 1 A266
- Dichloroanilino-ethane see Bis (chloroanilino)-
 ethane 2 B138
- Dichloroanilino-propane see Bis (chloroanilino)-
 propane 2 B138
- Dichloroazobenzene and derivs 5 D1204–D1205
 dinitrodichloroazobenzenes 5 D1204–D1205
 mononitrodichloroazobenzenes 5 D1204
 tetranitrodichloroazobenzenes 5 D1205

- N,N'-Dichloroazodicarboximidine** see α,α -Azobis (chloroformamide) **1 A652; 5 D1205**
- Dichloroazoxybenzene and derivs**
5 D1205–D1206
 dinitrodichloroazoxybenzene **5 D1206**
 mononitrodichloroazoxybenzene **5 D1205**
 3,5,3',5'-tetranitro-4,4'-dichloroazoxybenzene **5 D1206**
 trinitrodichloroazoxybenzene **5 D1206**
- Dichlorobenzene and derivs** **5 D1206–D1208**
 azido & diazo derivs of dichlorobenzene **5 D1206–D1207**
 commercial dinitrodichlorobenzene (Parazol) **5 D1207–D1208**
 nitro & nitroso derivs of dichlorobenzene **5 D1207–D1208**
- (5,7-Dichlorobenzo-6-nitro)-benzotriazol-1-ol** see Benzotriazol and derivs **2 B88**
- 6,7 (or 4,5)-Dichlorobenzotriazole-4,5 (or 6,7)-quinone** **3 C258**
- 5,6-Dichloro-benzo-triazol-1-ol** **2 B88**
- Di-(chlorobenzoyl) peroxide** **5 D1208**
- Dichlorodiaminoethane** **5 D1208–D1209**
- 3,5-Dichloro-2-diazo-p-xylene salts** **5 D1181**
- Dichlorodiethylenediamine complexes of cobalt** see Cobalt (III) dichlorodiethylenediamine chlorate and perchlorate **3 C384**
- Dichlorodifluoromethane (Freon 12)** **5 D1209**
- Dichloroethane and derivs** **5 D1209–D1210**
 nitro & nitroso derivs of dichloroethane **5 D1210**
- Dichloroethanemercarbide** **5 D150**
- Dichloroethanemercarbide diammoniate** **5 E150**
- N,N-Dichloroethylamine** **5 D1210**
- Dichloroethylene** **5 D1210–D1211**
- Dichlorohydrin and derivs** **5 D1211–D1212**
 dichlorohydrin, commercial **5 D1211–D1212**
 nitrate & nitrite derivs of dichlorohydrin **5 D1212**
- 1,4-Dichloroimino-benzoquinone** see Benzoquinonediiimine **2 B83**
- 3,5-Dichloroimino-3,5-dihydro-1,2,4-triazole** **5 D1212–D1213**
- 1,4-Di (chloroimino)-p-quinone** see Benzoquinone-1,4-di (chloroimine) **5 D1213**
- 4,5-Dichloroindazole-6,7-quinone** **5 D1213**
- Dichloromethane and derivs** **5 D1213**
 dinitrodichloromethane **5 D1213**
- Dichloromethyl-chloroformate** **2 C169**
- Dichlorophenol and derivs** **5 D1213–D1215**
 nitro derivs of dichlorophenol **5 D1214–D1215**
- Dichlorophenyl-azotetrazole** see Bis (chlorophenyl)-azotetrazole **2 B139**
- 2,6-Dichloropyridine-4-carboxylic acid azide** **5 D1215**
- 4,6-Dichloropyridine-2-carboxylic acid azide** **5 D1215**
- 2,6-Dichloroquinonechlorimide** **5 D1215**
- 1,7-Dichloro-2,4,6-trinitro-2,4,6-triazaheptane (GSX)** **5 D1215**
- Dichromates** **3 C283**
- Dichromates, listing** **3 C283–C288**
 ammonium dichromate **3 C283–C284**
 barium dichromate **3 C284**
 calcium dichromate **3 C284**
 lead dichromate **3 C284**
 potassium dichromate **3 C284–C287**
 sodium dichromate **3 C287–C288**
- Dicinnamoyl peroxide** **5 D1216**
- Dick** see Arsine and derivs **1 A491**
- Dickson powder** **5 D1216**
- Dicobaltocarbonyl** see Cobalt tetracarbonyl **3 C387**
- Dicoumariloyl peroxide** **5 D1216**
- Dicrotonyl peroxide** **5 D1216**
- Dicuminoyl peroxide** **5 D1216**
- Dicumyl peroxide of bis (α,α -dimethylbenzyl) peroxide** **5 D1216–D1217**
- Dicuproacetaldehyde** **1 A73**
- Dicyanamide** **5 D1217**

- Dicyanamideazide see Cyanoformamidine azide
3 C586; 5 D1217
- Dicyandiamide see Cyanoguanidine 3 C587
- Dicyandiamide nitrate see Cyanoguanidine nitrate
3 C588
- Dicyandiamidine and derivs 5 D1217–D1218
dicyandiamidine perchlorate 5 D1217
nitrodicyandiamidine 5 D1217–D1218
- Dicyandiazide 5 D1218
- 1,1'-Dicyanobicyclohexyl 5 D1218
- 1,2-Dicyanoethane 5 D1218
- Dicyanomethane 5 D1218
- Di-(cyanomethyl) amine and derivs
5 D1218–D1219
di-(cyanomethyl) nitramine 5 D1219
- 4,5-Dicyano-1,2,3-triazole 5 D1219
- Di-(cyclohexanecarbonyl)-peroxide see Bis
(hexahydrobenzoyl)-peroxide 2 B143
- 1,8-Dicyclohexylamino-3,6-diazaoctane and derivs
5 D1219
1,8-dicyclohexylnitramino-3,6-dinitro-3,6-
diazaoctane 5 D1219
- 7,7'-Dicyclohexyl-7,7'-butadiene-6,6'-dihydro-
peroxide 5 D1120
- Di (cyclohexyl)-ethylenediamine and derivs
5 D1219–D1220
nitro & nitroso derivs of di (cyclohexyl)-
ethylenediamine 5 D1220
- 1,3-Di (cyclohexyl)-imidazolidine and derivs
5 D1220
1,3-di (cyclohexyl)-imidazolidine dinitrate
5 D1220
- Dicyclopentylidene peroxide 3 C592
- Didi 5 D1220
- Didi (pulver) 5 D1220
- N,N'-Di (β , γ -di-hydroxy-propyl)-oxamide tetra-
nitrate see N,N' Bis (2,3-dihydroxypropyl)-
oxamide tetranitrate 2 B141
- Di-(2,6-dimethyl-pyridino)-diazido copper
5 D1220
- α,α -Di-(2,4-dinitrophenyl)-acetone 5 D1415
- 1,1-Di-(2,4-dinitrophenyl)-ethane 5 D1452
- N,N-Di-(2,2-dinitro-3-propylol) amine 5 D1502
- Di-(3,5-dinitro-2,4,6-trimethylbenzoyl)-furoxan
5 D1521
- Di-(3,5-dinitro-1,3,5-triazacyclohexylmethyl)-
ether see Bis (1,3,5-triaza-3,5-dinitrocyclo-
hexylmethyl)-ether 2 B159
- Dieckerhoff powders 5 D1220
- Diego de Alava y Viamont 5 D1220
- Diego Uffano 5 D1220–D1221
- Dielectric properties of expls 5 D1221–D1222
dielectric constant of expls 5 D1221–D1222
dielectric strength of expls 5 D1222
dissipation factor (of expls) 5 D1222
resistivity (of expls) 5 D1221
- Dielectrics and dielectric constants 5 D1222
- Diels-Alder synthesis 5 D1222–D1223
- "dien" 5 D1223
- Dienes 5 D1223 see Vinyls 10
- Dienite 5 D1223
- Dieterici (detonation) equation of state 4 D276
- Di-(ethanolamine)-trinitrate see Bis (β -nitroxy-
ethyl)-amine nitrate 2 B129
- Diethanol-piperazine see Bis (hydroxyethyl)-
piperazine 2 B146
- Diethoxy-azobenzene and its dinitro and hexa-
nitro derivs see Azo-phenatole 1 A656
- Diethoxyazoxybenzene and its trinitro deriv see
Azoxyphenetole 1 A670
- 1,1-Diethoxyethane 1 A13
- 1,9-Diethoxypentamethylene-2,4,6,8-tetramine
5 D1224
- 1,7-Diethoxy-2,4,6-trinitro-2,4,6-triazaheptane
5 D1224
- Diethylamine and derivs 5 D1224–D1226
diethylammonium diazido nitratocuprate
5 D1226
di-(ethylamino)-diazido copper salt 5 D1225

- Diethylamine and derivs (cont'd)
 diethylaminoethylguanidine and its nitrated
 deriv 1,1-diethyl-3 (2-nitraminoethyl)-2-
 nitroguanidine 5 D1224–D1225
 diethylaminoethylol dinitrate 5 D1225
 3-(β -diethyl-aminoethyl)- α -sym-triazole
 dipicrate 1 A209
 nitro and nitroso derivatives of diethylamine
 5 D1224–D1225
- 3-(β -Diethylaminoethyl)- α -sym-triazole
 dipicrate 1 A209
- Diethylammonium diazidonitratocuprate 5 D1226
- Diethylaniline and derivs 5 D1226–D1227
 azido derivs of diethylaniline 5 D1226
 N,N-diethylaniline pentaazidodicuprate
 5 D1227
 nitro and nitroso derivs of diethylaniline
 5 D1226–D1227
- Diethylbenzene and derivs 5 D1227–D1228
 dinitrodiethylbenzene 5 D1228
 mononitrodiethylbenzene 5 D1228
 2,4,6-trinitro-1,3-diethylbenzene 5 D1228
 2,3,6-trinitro-1,3-di (β -nitroxyethyl)-benzene
 5 D1228
- Diethylbenzidine and derivs 5 D1228–D1229
 N,N'-dinitroso-N,N'-diethylbenzidine 5 D1228
 N,N'-3,5,3',5'-hexanitro-N,N'-diethylbenzidine
 5 D1229
 N,N'-di-(2-nitroethyl)-benzidine 5 D1228
 3,5,3',5'-tetranitro-N,N'-diethylbenzidine
 5 D1228–D1229
- Diethylbenzylamine and derivs 5 D1229
 nitroderivs of diethylbenzylamine 5 D1229
- N,N'-Diethylcarbanilide see Centralite 1 2 C127
- Di (ethylcarboxamide)-piperazine
 5 D1229–D1230
 1,4-di [N (2',2',2'-trinitroethyl)-carboxamide]-
 piperazine 5 D1229–D1230
- Diethyldiborane 5 D1230
- N,N'-Diethyl-N,N'-diphenyl-urea see Centralite 1
 2 C127
- N,N'-Diethyl-N,N'-diphenyl-urea-nitroguanidine
 5 D1230
- Diethylenediamine (piperazine) and derivs
 5 D1230–D1231
 diethylenediamine complexes 5 D1231
 nitro and nitroso derivs of piperazine 5 D1231
- Diethyleneglycol and derivs 5 D1231–D1233
 diethyleneglycol dinitrate (DEDGN)
 5 D1232–D1233
 diethyleneglycol perchlorate 5 D1233
- Diethylenetriamine (DETA) see Bis (amino-
 ethyl)-amine 2 B128
- Diethylenetriamine complexes of cobalt see
 Cobalt (III) bis (diethylenetriamine)
 perchlorate 3 C383
- Diethylether and derivs 5 D1233–D1235
 1-azidodiethylether 5 D1235
 diethylether, peroxide formation 5 D1234
 di-(2-nitroethyl)-ether 5 D1235
 mononitrodiethyl ether 5 D1235
- Diethyl-ethylenediamine and derivs
 5 D1235–D1236
 N,N'-di-(2,2,2-trinitroethyl)-ethylenediamine
 5 D1235–D1236
- N,N'-Diethyl-ethyleneurea and deriv 5 D1236
 N,N'-di-(2,2,2-trinitroethyl)ethyleneurea
 5 D1236
- Diethyl-ethylmalonate and deriv 5 D1236
 diethyl-trinitro-ethylmalonate 5 D1236
- Diethylguanidine and derivs 5 D1236
 N,N-diethyl-nitroguanidines 5 D1236
- Di(2-ethylhexyl) adipate (DOA) 5 D1236–D1237
- Di-(2-ethylhexyl) azalate (DOZ) 5 D1237
- Di-(ethylhexyl)-phthalate see Bis (ethylhexyl)-
 phthalate 2 B142
- Di-(2-ethylhexyl) sebacate (DOS) 5 D1237
- Diethylhydrazine and derivs 5 D1237
 N,N'-di-(2,2,2-trinitroethyl) hydrazine 5 D1237
- Diethylhydroxylamine and derivs 5 D1237
 N-nitroso-O,N-diethylhydroxylamine 5 D1237
 di (2,2,2-trinitroethyl) hydroxylamine 5 D1237
- Diethylhyponitrite 5 D1238
- Diethylidene diperoxide 5 D1238

- Diethylketene peroxide 5 D1238
- Diethyl lead diazide 5 D1238–D1239
- Diethyl lead dibenzoate 5 D1239
- Diethyl mercury 5 D1239
- Diethyl-methylenediamine and derivs 5 D1239
N,N'-dinitro-N,N'-diethyl-methylenediamine
5 D1239
- N,N-Diethylnitroguanidines 5 D1236
- Di-(ethylnitrosamino)-azoxybenzene see
Bis (ethylnitrosamino)-azoxybenzene 2 B142
- Diethylolamine and derivs 5 D1239–D1242
diethylolamine dinitrate 5 D1240
diethylolamine trinitrate 5 D1242
di-(2-nitroxyethyl)-chloramine 5 D1242
di-(2-nitroxyethyl)-nitramine 5 D1240
di-(nitroxyethyl)-nitrosamine 5 D1240
- Di-(ethylolamino)-benzene and derivs
5 D1242–D1243
dinitro-1,3-di (ethylolamino)-benzene 5 D1242
2,4,6-trinitro-1,3-di (n-nitro- β -ethanolamino)-
benzene 5 D1242–D1243
- Di (ethylol)-ethylenediimine and derivs 5 D1243
N,N'-di-(2-ethylol ethylene diimine dinitrate
5 D1243
N,N'-di-(2-nitroxy-ethyl) ethylene-dinitramine
5 D1243
- Diethylol-oxamide and derivs 5 D1243–D1245
N,N' di (ethylol)-oximide dinitrate 5 D1244
N,N'-dinitro-N,N'-di (2-ethylol)-oxamide
dinitrate (NENO) 5 D1244–D1245
- Diethylol peroxide 5 D1245
- Diethylol-piperazine see Bis (hydroxyethyl)-
piperazine 2 B146
- Diethylol-propylenediamine and derivs
5 D1245–D1246
N,N'-bis (2-nitroxyethyl)-propylenedinitramine
5 D1246
N,N'-diethylol-propylenedinitramine 5 D1246
- N,N'-Diethylol-propylenedinitramine 5 D1246
- Diethylol-sulfamide and derivs 5 D1246
N,N'-dinitro-N,N'-di (2-nitroxyethyl)-sulfamide
5 D1246
- Diethyloxamide and derivs 5 D1246
N,N'-dinitro-N,N'-diethyloxamide 5 D1246
- Diethyl peroxide 5 D1246–D1247
- Diethyl peroxydicarbonate 5 D1247
- Diethylphenylbenzylammonium chlorate 2 C188
- Diethylphenylenediamine and derivs
5 D1247–D1248
nitro derivs of diethylphenylenediamine
5 D1247–D1248
- o-Diethylphthalate (DEP or DEtPh)
5 D1248–D1253
, analytical procedures 5 D1248–D1253
- 3,6-Diethyl-1,2,4,5-tetraketo-4,5-dihydropyrid-
azine 5 D1253
- Di (ethyltriazeno)-benzene see Bis (ethyltriazeno)-
benzene 2 B142
- Di (ethyl-s-triazole) 5 D1254
- Diethyltriazolyl-formamidine see N,N'-Bis (5-
ethyl-s-triazol-3-yl)-formamidine 2 B142
- Diethyltribromobenzene-azohydrazine-dicarboxy-
late 5 D1254
- N¹,N⁴-Diethyltriethylene tetranitramine 5 D1254
- Diethyltrinitroethylmalonate 5 D1236
- Diethylurea and derivs 5 D1254–D1255
1,3-di (2,2,2-trinitroethyl) urea
5 D1254–D1255
- Diferrocenyl 5 D1255
- Differential pressure measuring for examination
of proplnts 5 D1255
- Differential thermal analysis of expls, proplnts &
pyrots 5 D1255–D1256
- Diffusion 5 D1256–D1257
- Diffusion coefficients of solventless proplnts
5 D1257–D1258
- Diffusion of NG in double base proplnts 5 D1258
- Di-flamyr 5 D1258
- Difluramino compds 5 D1258
- Difluorenyl-diperoxide see 9,9'-Bis (fluorenyl)-
diperoxide 2 B143

- Di-(fluorenylidenehydro)-tetrazine see 3,6-Bis (fluorenylidenehydro)-sym-tetrazine 2 B143
- Difluorobenzene and derivs 5 D1258–D1259
 difluorobenzene diazooxide 5 D1259
 3,4 (or 6)-difluoro-2-nitro-1-diazo-4 (or 6)-oxides 5 D1259
 dinitrodifluorobenzenes 5 D1259
 mononitrodifluorobenzenes 5 D1258
 2,4,6-trinitro-1,3-difluorobenzene (TNDFB or DFTNB) 5 D1259
- 1,3-Diformadinoguanidine 5 D1260
- sym-Diformylhydrazine 5 D1260
- Di-2-furoyl peroxide 5 D1260
- Difuryl see Bifuryl 2 B113
- Difurylacryloyl peroxide 5 D1260–D1261
- Diglycerol and derivs 5 D1261–D1262
 diglycerolpentaerythritol ether 5 D1261
 diglycerolpentaerythritol ether hexanitrate 5 D1261–D1262
 diglycerol tetranitrate 5 D1261
- Diglycolamic acid 5 D1262
- Diglycolamidic acid and derivs 5 D1262
 diglycolamidic diazide 5 D1262
 nitrodiglycolamic acid dinitril 5 D1262
 nitrodiglycolamidic acid 5 D1262
 nitrosodiglycolamidic diazide 5 D1262
- Diglycolic acid (and its reaction products) 5 D1262–D1263
- Diguanide see Biguanide 2 B114
- Diguanidine see Biguanidine 2 B115
- Di-[1-(3-guanyltriazene)-5-tetrazolyl] diazene 5 D1263
- Diharnstoff see 4-Amino-urazole 1 A272
- Di (hexahydrobenzoyl)-peroxide see Bis (hexahydrobenzoyl)-peroxide 2 B143
- Dihydrazide-dihydro-tetrazene see 3,6-Bis (hydrazide)-1,2-dihydro-1,2,4-tetrazine 2 B143
- Dihydrazinotoluene and derivs 5 D1263–D1264
 2,4-dinitro-3,5-dihydrazinotoluene 5 D1264
- Dihydrazone oxamide 5 D1264
- Dihydro- 5 D1264
- Di (hydroanthranol) 2 B144
- 4',4'-Dihydro-5',5'-azinotetrazole see Bis (5-tetrazole)-hydrazine 2 B157; 5 D1264
- Dihydrodiketonebenzene see Benzoquinone 2 B79
- 1,3-Dihydro-2,2-dimethylperimidine and deriv 5 D1264
 1,3-dihydro-2,2-dimethyl-4,6,7,9-tetranitroperimidine 5 D1264
- 5,6-Dihydro-6-imino-2,4 (1,3H)-s-triazinedione see Ammelide 1 A273
- 4,5-Dihydro-5-isonitro-4'-methyl-4-methylene-1,1',5'-trinitro-2,2'-biimidazole methyl ester 5 D1265
- 1,2-Dihydro-1-methylnitro-2-nitroiminopyridine 5 D1265
- Dihydropentaborane see Boron hydrides 2 B254
- Di (hydroperoxy cyclohexyl)-peroxide see 1,1'-Bis (hydroperoxycyclohexyl)-peroxide 2 B144
- 1,1'-Dihydroperoxy-1,1'-dicyclohexylacetylene see Acetylene hydroperoxides and peroxides 1 A66
- Di (hydroperoxydimethyl)-hexane see 2,5-Bis (hydroperoxy-2,5-dimethyl)-hexane 2 B144
- 1,6-Dihydroperoxy-(1,6-endo-peroxy)-cyclodecane (?) 5 D1265–D1266
- 9,9'-Di (hydroperoxy)-9,9'-fluorene see 9,9'-Bis (benzoylperoxy-fluorenyl)-peroxide 2 B136
- 9,9'-Di (hydroperoxy)-9,9'-fluorene + 2 fluorenones (adduct) see 9,9'-Bis (hydroperoxy)-9,9'-fluorene + 2 fluorenones (adduct) 2 B145
- 2,3-Dihydro-4H-pyran 5 D1266
- 6,7-Dihydro-5H-pyrrolo-tetrazole 5 D1266
- 1,2-Dihydro-sym-tetrazine 5 D1266
- 1,2-Dihydro-sym-tetrazine-3,6-dicarboxylic acid 5 D1267
- 1,2-Dihydro-sym-tetrazine-3 (4H)-one 5 D1267
- Di [4-hydro-tetrazolyl]-5] -azine see Bis (5-tetrazole)-hydrazine 2 B157; 5 D1267
- Dihydro-triazine-diol 5 D1267

- Dihydroxy **5** D1267
- 2,4-Dihydroxyacetophenone **5** D1267–D1268
- Dihydroxyanthraquinone and derivs
5 D1268–D1269
 nitro derivs of dihydroxyanthraquinone
 5 D1268–D1269
- Dihydroxyazobenzene and derivs **5** D1269
 p-dihydroxyazobenzene dichromate **5** D1269
 hexanitrodihydroxyazobenzene **5** D1269
- Dihydroxyazoxybenzene see Azoxyphenol **1** A671
- Dihydroxybenzaldehyde and derivs
5 D1269–D1270
 nitro derivs of dihydroxybenzaldehyde
 5 D1270
- Dihydroxybenzene and derivs **5** D1270–D1288
 dinitro derivs (& salts) of dihydroxybenzene
 5 D1273–D1276
 mononitro derivs (& salts) of dihydroxybenzene
 5 D1271–D1273
 trinitro derivs (& salts) of dihydroxybenzene
 5 D1276–D1288
- Dihydroxybenzoic acid and derivs
5 D1288–D1289
 2,4-dihydroxybenzotrile **5** D1289
 nitro derivs of dihydroxybenzoic acid **5** D1289
- Dihydroxybenzoquinone and derivs
5 D1289–D1290
 anhydro-(6-nitro-2,5-dihydroxy-p-benzoquinone-3-diazo-hydroxide) **5** D1290
 3,6-dinitro-2,5-dihydroxy-1,4-benzoquinone
 5 D1290
 3-nitro-2,5-dihydroxy-1,4-benzoquinone
 5 D1290
- Di (hydroxybenzyl)-peroxide see Bis (α -hydroxybenzyl)-peroxide **2** B145
- Dihydroxy biphenyl and derivs see Biphenol and derivs **2** B122
- 1,1'-Dihydroxy-(5,5'-bis-tetrazole) see 5,5'-Bis (1-hydroxytetrazole) **2** B148
- Dihydroxybitolyl see Biresol **2** B112
- Dihydroxybutane see Butanediol **2** B368
- Di (hydroxycyclohexyl)-peroxide see Bis (1-hydroxycyclohexyl)-peroxide **2** B145
- 1,1'-Dihydroxycyclohexyl-1,1'-peroxide see Bis (1-hydroxycyclohexyl) peroxide **2** B145
- 1,1'-Dihydroxycyclooctyl-1,1'-peroxide **3** C592
- 1,1'-Dihydroxycyclopentyl-1,1'-peroxide **3** C592
- Dihydroxy-di (hydroanthracene) see Bis (hydroanthranol) **2** B144
- Dihydrodiketobenzene see Benzoquinone **2** B79
- Dihydroxydimethyldiazo-aminobenzene and deriv
 2,2'-dihydroxy-4,4'-dimethyl-3,5,3',5'-tetra-nitrodiazoaminobenzene **5** D1291
- Dihydroxydimethylethylmethane and deriv
5 D1291
 2,2-dimethyl-1,3-propane dinitrate **5** D1291
- Dihydroxydimethyldioxy piperazine and deriv
5 D1291
 1,4-dinitro-3,6-dioxy-2,5-dimethylpiperazine
 5 D1291
- 1,1'-Dihydroxy-5,5'-ditetrazolyl-tetrazole see 5,5'-Bis (1-hydroxy-tetrazole) **2** B148; **5** D1292
- 3,4-Dihydroxy-2,5-furandicarbonyl diazide
5 D1292
- Dihydroxy-iso-butane see iso-Butanediol **2** B370
- Dihydroxylaminobenzene and derivs
5 D1292–D1293
 4,6-dinitro-1,3-dihydroxylaminobenzene
 5 D1292–D1293
 N,N'-dinitroso-N,N'-dihydroxylaminomethane
 5 D1293
 1,4-Di (nitroso-hydroxylamino) benzene
 5 D1292
- m-Dihydroxylone diazonide **5** D1293
- Dihydroxymethylantraquinone and derivs
5 D1293–D1294
 1,8-dihydroxy-3-methyl-2,4,5,7-tetranitro-anthraquinone **5** D1293–D1294
- Dihydroxynaphthalene and derivs
5 D1294–D1295
 dinitrodihydroxynaphthalenes **5** D1294
 2,4,6,8- (or X,X,X,X-) tetranitro-1,5- (or 2,7-) dihydroxynaphthalene **5** D1294–D1295
 2,4,6-trinitro-1,5-dihydroxynaphthalene
 5 D1294

- Di (hydroxyphenyl)-anthranone and its hexa-nitrate see Bis (hydroxyphenylanthranone and derivs 2 B147
- Di (hydroxyphenyl)-propane and deriv see Bis (hydroxyphenyl)-propane 2 B147
- Di (hydroxyphenyl)-sulfone and deriv see Bis (hydroxyphenyl)-sulfone 2 B148
- Dihydroxypyridinecarboxylic acid and deriv 5 D1295
3,5-dinitro-2,6-dihydroxypyridine-4-carboxylic acid 5 D1295
- Dihydroxytetramethylenetriamine and derivs 5 D1295
1,7-dinitroxy-1,3,5,7-tetramethylene-2,4,6-triamine (ATX or NBSX) 5 D1295
- Dihydroxytetrazole see Bis (hydroxytetrazole) 2 B148
- Di (1-hydroxytetrazolyl-5) see Bis (1-hydroxy-tetrazole) 2 B148; 5 D1296
- Dihydroxytoluene and derivs 5 D1296–D1297
di (hydroxytoluene)-triazene 5 D1297
dinitrodihydroxytoluene 5 D1296
mononitrodihydroxytoluene 5 D1296
2,4,6-trinitro-3,5-dihydroxytoluene 5 D1296
- Dihydroxytriazinylformaldoxime 5 D1297
- Di (hydroxytrichloroethyl)-peroxide see Bis α -hydroxy- β,β,β -trichloroethyl)-peroxide 2 B148
- Dihydroxytrimethylenediamine and deriv 5 D1297
1,5-dinitroxytrimethylene-2,4-dinitramine 5 D1297
- Diimidazole see Biimidazole 2 B115
- Diimidazoline see Biimidazoline 2 B115
- Diiminooxalic acid dihydrazide and derivs 5 D1297–D1298
diimino-oxalic acid-bis (4,4,4-trinitro-3-methyl-butylidene) dihydrazide 5 D1297–D1298
diimino-oxalic acid dihydrazide dinitrate 5 D1297
- 1,4-Diimino-p-quinone see Benzoquinone-1,4-diimine 2 B83
- [3,6-Diimino-1,2,3,6-tetrahydro]-sym-tetrazine 5 D1298
- Diiodoacetylene 5 D1298
- Diiododiacetylene 5 D1298
- Diiododiphenyl diazide 5 D1298
- Diiodofumaric acid 5 D1298
- 4,4'-Diiodosodiphenyl 5 D1298–D1299
- 4,4'-Diiodoxydiphenyl 5 D1299
- Diisoalkylphthalates 5 D1299
- Di(iso-butylammonium)-triazole-copper 5 D1196
- Diisobutyl ketone 5 D1299
- Diisobutyryl peroxide 5 D1201
- Diisopropylbenzidine and derivs 5 D1495–D1496
N,N'-3,5,3',5'-hexanitro-N,N-diisopropylbenzidine 5 D1496
3,5,3',5'-tetranitro-N,N-diisopropylbenzidine 5 D1496
- Di (isopropyl)-peroxide 5 D1500
- Di (isoquinolino)-diazido copper (II) complex 5 D1503
- Diketopiperazine and derivs 5 D1299–D1300
1,4-dinitrodiketopiperazine 5 D1299–D1300
silver diketopiperazine 5 D1299
- Dilauroyl peroxide 5 D1300
- Dilithium acetylde 1 A77
- Dimazine 5 D1300
- Dimedone see Dimethylcyclohexanedione 5 D1333
- Dimensional analysis 5 D1300
- Dimeres fluorenonperoxyd see 9,9'-Bis (fluorenyl)-diperoxide 2 B143
- Dimeric acetone peroxide see Acetone peroxide, dimeric 1 A41
- Dimeric cyclohexanone peroxide see Cyclohexanone peroxide 3 C598
- Dimethoxyaniline and derivs 5 D1301–D1302
dinitrodimethoxyanilines 5 D1031–D1302
mononitrodimethoxyanilines 5 D1301
- Dimethoxyazobenzene and derivs see Azoanisole and derivs 1 A646

- Dimethoxybenzaldehyde and derivs 5 D1302
nitro derivs of dimethoxybenzaldehyde
5 D1302
- Dimethoxybenzene and derivs 5 D1302–D1303
dinitrodimeoxybenzene 5 D1302
mononitrodimeoxybenzene 5 D1302
trinitrodimeoxybenzenes 5 D1302
- Dimethoxybenzophenone and derivs 5 D1303
3,3'-dimethoxy-2,4,6',4'-pentanitro-benzo-
phenone 5 D1303
dimethoxy-3,3',5,5'-tetranitro-benzophenone
5 D1303
- o,o'-Dimethoxybenzoyl peroxide 5 D1303
- Dimethoxy-biphenyl see Dianisole 5 D1151
- Dimethoxy-bis (phenylmercapto)-benzene and
derivs 5 D1303
hexanitrodimeoxy-bis (phenylmercapto)
benzene 5 D1303
- Di (methoxymethyl)-peroxide and deriv 5 D1303
hydroxymethyl hydroperoxide 5 D1303
- Dimethoxynaphthalene and derivs 5 D1304
2,4,6,8-tetranitro-1,5-dimethoxynaphthalene
5 D1304
- Dimethoxypentamethylenetetramine and derivs
5 D1304
2,4,6,8-tetranitranitramine-1,9-dimethoxy-
1,3,5,7-pentamethylene 5 D1304
- Dimethoxyphenol and derivs 5 D1304
dimethoxypicric acid 5 D1304
- 2,4-Dimethoxyphenylarsinic acid and derivs
5 D1304
X-dinitro-3,4-dimethoxyphenylarsinic acid
5 D1304
- 1,1'-Di-o-methoxyphenyl-5,5'-azotetrazole
5 D1304
- Dimethoxytetramethylenetriamine and derivs
5 D1305
1,7-dimethoxy-1,3,5,7-tetramethylene-2,4,6-
trinitramine 5 D1305
- Dimethoxytoluene and derivs 5 D1305
dinitrodimeoxytoluenes 5 D1305
mononitrodimeoxytoluenes 5 D1305
trinitrodimeoxytoluenes 5 D1305
- Dimethylacetylene and derivs 5 D1305
hexanitrodimeethylacetylene 5 D1305
7,8-dimeethylacetylendiurein 5 D1305
- Dimethylamine and derivs 5 D1305–D1306
dimethylamine chlorite 5 D1305
1,1'-dinitramino-N-nitrodimeethylamine
5 D1306
N-nitrodimeethylamine 5 D1306
N-nitrosodimeethylamine 5 D1306
- Dimethylaminoaniline and derivs 5 D1306–D1307
pentanitrodimeethylaminoaniline
5 D1306–D1307
- Dimethylamino-anthraquinone see Bis (methyl-
amino)-anthraquinone 2 B148
- Dimethylaminoazobenzene and derivs 5 D1307
4,6,4'-trinitro-3-dimeethylaminoazobenzene
5 D1307
- Dimethylaminobenzaldehyde and derivs 5 D1307
mononitrodimeethylaminobenzaldehydes
5 D1307
- 1,2-Di (N-methylaminobenzene) see Bis (anilino)-
ethane 2 B131
- Dimethylaminobenzeneazotriazole azide 5 D1307
- Di (methylamino)-benzil see Bis (methylamino)-
benzil 2 B149
- Dimethylaminobenzoic acid and derivs 5 D1308
2,5-dinitro-2-dimeethylaminobenzoic acid
5 D1308
3,4-dinitro-4-dimeethylaminobenzoyl azide
5 D1308
3,X,X-trinitro-dimeethylamino-p-benzoic acid
5 D1308
- Di(methylamino)-benzophenone see Bis (methyl-
amino)-benzophenone 2 B149
- Dimethylamino-benzophenoneimide see Auramine
1 A507
- N,N-Dimeethylaminobiphenyl and derivs 5 D1308
3,4'-dinitro-4-dimeethylaminobiphenyl 5 D1308
2,6,2',4'-tetranitro-N,N-dimeethyl-p-amino-
biphenyl 5 D1308
- Dimethylaminocyanophosphoric acid, mono-
methylester of 5 D1308–D1309
CF see Cyclohexylmethylphonofluoridate
5 D1309

- Dimethylaminocyanophosphoric acid (cont'd)
 sarin (GB) or trilon 46 see Methylisopropoxy-
 fluorophosphine oxide 5 D1309
 soman (GD) see Methylpinacolyloxyfluoro-
 phosphine oxide 5 D1309
 trilons see 5 D1308–D1309
- Di (methylamino)-diazido-copper (II) 5 D1309
- Dimethylaminodiphenylamine and derivs 5 D1310
 2,3,2',4',6'-pentanitro-3-dimethylamino-
 diphenylamine 5 D1310
- Di (methylamino)-diphenylmethane see Bis
 (methylamino)-diphenylmethane 2 B149
- 2-Dimethylaminoethanol and derivs 5 D1310
 2-dimethylaminoethanol nitrate 5 D1310
- 3 β -Dimethylaminoethyl-1,2,4-triazole dipicrate
 5 D1310
- Dimethylaminohydroxylaminoazobenzene and
 derivs 5 D1310
 4,6-dinitro-3-dimethylamino-4'-hydroxylamino-
 azobenzene 5 D1310
- Dimethylaminomethylaminotoluene and derivs
 5 D1310–D1311
 3,5-dinitro-2-dimethylamino-4-methylamino-
 toluene 5 D1310–D1311
- Di (methylaminomethyl)-methylamine see Bis
 (methylaminomethyl)-methylamine 2 B149
- Dimethylaminophenol and derivs 5 D1311
 dinitrodimehylaminophenols 5 D1311
- Dimethylaminophenyl-methylamine and derivs
 5 D1311
 2,4,6-trinitro-3-dimethylaminophenylmethyl
 nitrosamine 5 D1311
- Dimethylaminopropane and derivs 5 D1311
 2,2-dimethyl-1,3-dinitroaminopropane 5 D1311
- Dimethylaminopyridine and derivs 5 D1312
 3,5-dinitro-2-dimethylaminopyridine 5 D1312
- Dimethylaminosuccinic acid and derivs 5 D1312
 dimethylaminosuccinic acid dihydrazide
 5 D1312
- 1,5-Di (methylamino)-tetranitroanthraquinone see
 Tetranitro-bis (methylamino)-anthraquinone
 2 B149
- 5-Dimethylamino- α -tetrazole 5 D1312
- Di (methylamino)-toluene see Bis (methylamino)-
 toluene 2 B150
- Dimethylammonium-diazidechlorocuprate
 5 D1312
- Dimethylammonium-diazidenitratocuprate
 5 D1312–D1313
- Dimethylammonium nitrate (disalz) 5 D1313
- Dimethylammonium-pentazidocuprate 5 D1313
- Dimethylammonium-tetrazidocuprate 5 D1313
- Dimethylanilines and derivs 5 D1313–D1318
 N,N-dimethylaniline-p-azide 5 D1318
 N,N-dimethylaniline-p-azido-picrate 5 D1318
 dimethylanilines (xylidines) 5 D1316–D1317
 dinitrodimehylaminilines 5 D1317
 dinitro-N,N-dimethylanilines 5 D1315
 mononitro-N,N-dimethylanilines 5 D1315
 pentanitro-N,N-dimethylaniline 5 D1316
 2,3,4,6 (or 2,4,5,6)-tetranitro-N,N-dimethyl-
 aniline (tetralita no 1) 5 D1316
 2,4,6-trinitro-3,5-dimethyl-1-aniline 5 D1317
 trinitro-N,N-dimethylanilines 5 D1315
 2,4,6-trinitro-3,5-dimethyl-1-dinitroaniline
 5 D1317
- N,N-Dimethylaniline-4-diazonium hydroxide
 and derivs 5 D1318
 chloride 5 D1318
 perchlorate 5 D1318
- N,N-Dimethylaniline-pentazido-dicuprate 5 D1318
 [(p-N,N-Dimethylanilino)-(tetrazolyl-5)]-diazine
 5 D1318–D1319
- Dimethylanisole and derivs 5 D1319
 dinitrodimehylanisole 5 D1319
 mononitrodimehylanisole 5 D1319
 trinitrodimehylanisole 5 D1319
- 3,5-Dimethyl-4-azido-pyrazole 5 D1370
- Dimethylazobenzene see Azotoluene 1 A660
- 1,1' (or 2,2')-Dimethyl-5,5'-azotetrazole 5 D1320
- Dimethylazoxybenzene see Azoxytoluene 1 A672
- Dimethylazoxyethane see Azoxypropane 1 A671
- Dimethylbenzaldehyde and derivs 5 D1320
 2-azido-3,5-dimethylbenzaldehyde 5 D1320
 mononitrodimehylbenzaldehyde
 5 D1320–D1321

- Dimethylbenzene and derivs 5 D1321–D1325
 azidodimethylbenzene 5 D1321
 azidodinitrodimehylbenzene 5 D1324
 azidonitrodimehylbenzene 5 D1322
 dinitrodimehylbenzene 5 D1323–D1324
 dinitrosodimehylbenzene 5 D1322
 4,5-dinitroso-2-nitro-1,3-dimehylbenzene
 5 D1323
 5,6-dinitroso-2-nitro-1,4-dimehylbenzene
 5 D1323
 mononitrodimehylbenzene 5 D1321–D1322
 mononitrosodimehylbenzene 5 D1321
 nitrosodimehylbenzene 5 D1322
 $\alpha,\alpha,\alpha',\alpha'$ -tetranitro-1,3-dimehylbenzene
 5 D1325
 trinitrodimehylbenzenes 5 D1324–D1325
- Dimethylbenzidine and derivs 5 D1325–D1326
 hexanitro- N,N' -dimehylbenzidine 5 D1326
 N,N' -4,4',6,6'-hexanitro- N,N' -dimehyl-
 benzidine 5 D1326
 3,5,3',5'-tetranitro- N,N' -dimehylbenzidine
 5 D1326
- Dimethylbenzoic acid and derivs 5 D1326–D1327
 2-azido-3,5-dimehylbenzoic acid 5 D1326
 dinitrodimehylbenzoic acids 5 D1327
 X,X -dinitroso-2,4-dimehylbenzoic acid (?)
 5 D1326
 mononitrodimehylbenzoic acids
 5 D1326–D1327
 X -nitroso- X -nitro-2,4-dimehylbenzoic acid (?)
 5 D1327
- Dimethylbenzophenone and derivs
 5 D1327–D1328
 3,5,3',5'-tetranitro-2,4-dimehylbenzophenone
 5 D1327–D1328
 trinitrodimehylbenzophenone 5 D1327
- Dimethylbenzylamine and derivs 5 D1328
 2,4-dimehylbenzylazide 5 D1328
 α,α -dimehylbenzyl hydroperoxide (DMBH)
 5 D1328
 2,4 (or 4,6)-dinitro-3,5-dimehylbenzylamine
 5 D1328
- Dimethylbiguanides 5 D1328–D1329
- Dimethyl-biimidazole and derivs 5 D1329
 4,4'-dimehyl-1,1',5,5'-tetranitro-2,2'-biimida-
 zole 5 D1329
- Dimethyl-biphenyl see Bitolyl 2 B163
- N,N' -Dimethyl- N,N' -bis [phenyl]-urea see
 Centralite 2 2 C137ff
- N,N' -Dimethyl- N,N' -bis [2,4-dinitrophenyl]-
 urea see Tetranitrocentralite 2 B139; 5 D1329
- N,N' -Dimethyl- N,N' -bis [X,X,X -trinitrophenyl]-
 urea see Hexanitrocentralite 2 C139; 5 D1329
- Dimethylbiuret and derivs 5 D1329
 1,5-dinitroso-1,5-dimehylbiuret 5 D1329
- Dimethylborylmethyl peroxide 5 D1329
- Dimethylbutadiene and derivs 5 D1329–D1330
 2,3-dimehylbutadiene peroxide, polymeric
 5 D1329–D1330
- Dimethylbutane and derivs 5 D1330
 dimehyldinitrobutanes 5 D1330
- Dimethylbutene and derivs 5 D1330–D1331
 1,4-dinitro-2,3-dimehylbutene-(2) 5 D1331
 4-nitroso-1-nitro-2,3-dimehylbutene (2)
 5 D1331
- Di (methyl)-butene-1 and derivs 5 D1331
 3,3-di (nitratomethyl)-butene-1 5 D1331
- 1,3-Dimehyl-5-tert-butylbenzene and derivs
 5 D1331
 2-azido-4,6-dinitro-1,3-dimehyl-5-tert-butyl-
 benzene 5 D1331
 2,4,6-trinitro-1,3-dimehyl-5-tert-butylbenzene
 5 D1331
- Di (3-methylbutynyl)-3-peroxide see Bis (1,1-
 dimehyl-2-propynyl)-peroxide 1 A66
- Dimethylbutyric acid and derivs 5 D1331–D1332
 3,3-dinitro-2,2-dimehylbutyric acid 5 D1332
- Dimethyl-cadmium 5 D1332
- Dimethylcamphorate 5 D1332
- Dimethylcarbamoyl azide 5 D1332
- N,N -Dimethyl-carbanilide see Centralite 2 2 C137
- Dimethylcoumarin and derivs 5 D1332
 3,5,8-trinitro-6,7-dimehylcoumarin 5 D1332
- Dimethylcumene and derivs 5 D1332–D1333
 2,4,6-trinitro-3,5-dimehylcumene 5 D1333
- Dimethylcyclohexanedione and derivs 5 D1333
 2-nitro-5,5-dimehyl-1,3-cyclohexanedione
 5 D1333

- 3,8-Dimethyl-4,6-decadiyn-3,8-dihydroperoxide
5 D1120–D1121
- Dimethyldiallylsilane 5 D1333
- Dimethyl-diaminotartaric acid and derivs 5 D1334
N,N'-dinitro-N,N'-dimethyl-diaminotartaric acid
dinitrate 5 D1334
- 4,4'-Dimethyl-3,3'-diazoaminofurazan 5 D1334
- 2,5-Dimethyl-2,5-di (t-butylperoxy)-3-hexyne see
Acetylene hydroperoxides and peroxides 1 A66
- N,N'-Dimethyl-N,N'-dibutyltetrazine (1) 5 D1334
- 2,5-Dimethyl-2,5-dihydroperoxy-3-hexyne see
1,1,4,4-tetramethyl-2-butylenedihydro-
peroxide 1 A66
- 3,6-Dimethyl-1,2-dihydro-1,2,4,5-tetrazine
5 D1334
- Dimethyldiketopiperazine and derivs 5 D1335
1,4-dinitro-3,5-dimethyl-2,5-diketopiperazine
5 D1335
- Dimethyl-dimethylene-triamine and derivs
5 D1335–D1336
1,1-dimethyl-2,2-dimethylethane-1-hydro-
peroxide-nitrobenzoate 5 D1335–D1336
1,5-dimethyl-2,4-dimethylene-1,3,5-trinitramine
5 D1335
- Dimethyldinitrobutanes 5 D1330
- Dimethyldinitro-m-phenylenediamines 5 D1364
- 2,2-Dimethyl-1,3-dinitropropane 5 D1368
- 3,5-Dimethyl-1,4-dinitropyrazole 5 D1371
- N,N'-Dimethyl-N,N'-dinitroso-m-phenylene
diamine 5 D1364
- Di [N (methyl-dinitrophenyl)-nitramino]-propane
see 1,3-Bis [N (4'-methyl-2',6'-dinitrophenyl)-
nitramino]-propane 2 B151
- 4,6-Dimethyl-3,5-dinitro-2-(1H) pyridone 5 D1371
- N,N'-Dimethyl-N,N'-dinitrotartramide dinitrate
5 D1374
- N,N-Dimethyl-dinitro-toluidines 5 D1375–D1376
- 1,3-Dimethyl-1,3-dinitrourea 5 D1378
- Dimethyldiphenyl see Bitolyl and derivs 2 B163
- Dimethyldiphenylamine and derivs 5 D1336
3,3' (or 4,4')-dimethyl-2,4,6,2',4',6' (or
2,3,5,2',3',5')-hexanitrodiphenylamine 5 D1336
- Dimethyldiphenyldiamine and derivs 5 D1336
N,N',4,4',6,6'-hexanitro-N,N'-dimethyl-3,3'-
diphenyldiamine 5 D1336
4,6,4',6'-tetranitro-N,N-dimethyl-3,3'-di
(methylamino)-diphenyl 5 D1336
- Dimethyldiphenylether and derivs 5 D1337
tetranitrodiphenylether 5 D1337
- N,N'-Dimethyl-N,N'-diphenylurea see Centralite 2
2 C137; 5 D1337
- Dimethyleneperoxidecarbamide 5 D1337
- Dimethyleneperoxide-ethylamine 5 D1337
- Dimethylether 5 D1338
- Di (methylether)-peroxide 5 D1338
- Dimethyl-ethyl-acetate and derivs 5 D1338
1,1-dimethyl-2,2,2-trinitroethylacetate 5 D1338
- Dimethylethylenediamine and derivs
5 D1338–D1339
N,N'-dimethyl-N,N'-dinitroethylenediamine
(M₂EDNA) 5 D1338
N,N'-dimethyl-N,N'-dinitroso-ethylenediamine
5 D1338
- asym-Dimethylethyleneglycol see iso-Butanediol
2 B370
- sym-Dimethylethyleneglycol see Butanediol
2 B368
- Dimethyl-9-fluorenone and derivs 5 D1339
2,4,7-trinitro-1,3-dimethyl-9-fluorenone
5 D1339
- N,N-Dimethylformamide (DMF) 5 D1339–D1340
- Dimethyl-3-furoyl azide 5 D1340
- Dimethylglycolurethane and derivs 5 D1340
N,N-dimethylglycolurethane nitrate 3 D1340
- Dimethylglycoluril and derivs (DMGU)
5 D1340–D1341
1,3-dinitro-7,8-dimethylglycoluril (DNDMGU)
5 D1340–D1341
- Dimethylglyoxime and derivs 5 D1341
- Dimethylguanidine and derivs 5 D1341
N,N-dimethyl-N'-nitroguanidine 5 D1341

- Dimethylguanylpiprazole and derivs 5 D1342
3,5-dimethyl-4-nitro-1-nitroguanylpiprazole
5 D1342
- Dimethylhexadiene and derivs 5 D1342–D1343
1,5-dimethylhexadiene diozonide 5 D1342
- 1,12-Dimethyl-2,3,5,6,10,11-hexamethylene-7-
oxa-8-nitroso-9-nitrilo-1,4,12-trinitrimine
5 D1342
- 1,10-Dimethyl-2,3,5,6,8,9-hexamethylene-
1,4,7,10-tetranitrimine 5 D1342–D1343
- Dimethylhexane and derivs 5 D1343
2,5-dimethylhexane-2,5-dihydroperoxide
5 D1343
2,5-dinitro-2,5-dimethylhexane 5 D1343
X,X,X-trinitro-2,5-dimethylhexane 5 D1343
- 3,3' (or 4,4')-Dimethyl-2,4,6,2',4',6' (or
2,3,5,2',3',5')-hexanitrodiphenylamine
5 D1336
- 17,17-Dimethyl-7,8-15,16,17,18,19-hexaoxa-
dispiro-[5.2.5.5]-nonadecane see 1,1'-Bis
(hydroperoxycyclohexyl)-peroxide 2 B144
- Dimethylhydantoin and derivs 5 D1343–D1344
1,3-dinitro-5,5-dimethylhydantoin
5 D1343–D1344
1-nitro-5,5-dimethylhydantoin 5 D1343
- uns-Dimethylhydrazine (UDMH)
5 D1344–D1346; 10 U1–U25
- Dimethylhydrazine and derivs 5 D1344–D1346
sym-dimethylhydrazine 5 D1346
uns-dimethylhydrazine (UDMH)
5 D1344–D1346; 10 U1–U25
N-nitroso-N,N'-dimethylhydrazine 5 D1346
- 1,1'-Dimethyl-5,5'-hydrazo-1H-tetrazole 5 D1346
- Dimethylhydrogenphosphite 5 D1347
- 1,4-Di (methylimino)-p-quinone see Benzo-
quinone-1,4-di (methylimine) 2 B83
- 1,3 (or 1,4)-Dimethyl-5-iminotetrazole 5 D1122
- Dimethylindazole and derivs 5 D1347
4 (or 6)-azido-5,7-di-methylindazole 5 D1347
dinitrodimethylindazole 5 D1347
mononitrodimethylindazole 5 D1347
- Dimethylketene and derivs 5 D1347–D1348
dimethylketene peroxide 5 D1348
- Dimethylketone same as Acetone 1 A33–A35
- Dimethylmalonamide and derivs 5 D1348
N,N'-dinitro-N,N'-dimethylmalonamide
5 D1348
N-nitro-N,N'-dimethylmalonamide 5 D1348
- Dimethylmethanedi-amine and derivs 5 D1348
N,N'-dinitro-N,N'-dimethylmethanedi-amine
5 D1348
- Dimethylmethylenediaminoguanidine and derivs
5 D1348
N'-nitrodimethylenediaminoguanidine 5 D1348
N'-nitromethylenediaminoguanidine 5 D1348
- Dimethylmethylgalactoside and derivs 5 D1349
dimethyl-x-methylgalactoside-Y,Y-dinitrates
5 D1349
- Dimethylmethylglucoside and derivs
5 D1349–D1350
x,x-dimethylmethylglucoside-Y,Y-dinitrate
5 D1349–D1350
- N',N'-Dimethyl-4-mononitro-m-phenylenediamine
5 D1364
- Dimethylnaphthalene and derivs 5 D1350
1,4,5 (?) -trinitro-2,6-dimethylnaphthalene
5 D1350
- 2,4-Di (methylnitramino)-3,5-dinitrotoluene see
2,4-Bis (methylnitramino)-3,5-dinitrotoluene
2 B150
- Di (methylnitraminomethyl)-methylnitramino-
methyl)-methylamine 2 B149–B150
- 4,4'-Di (methylnitramino)-3,5,3',5'-tetranitro-
benzophenone see 4,4'-Bis (methylnitramino)-
3,5,3',5'-tetranitro-benzophenone 2 B149
- 4,4'-Di (methylnitramino)-3,5,3',5'-tetranitro-
diphenylmethane see 4,4'-Bis (methylnitra-
mino)-3,5,3',5'-tetranitrodiphenylmethane
2 B149
- 3,5-Di (methylnitramino)-2,4,6-trinitrotoluene see
3,5-Bis (methylnitramino)-2,4,6-trinitrotoluene
2 B150
- N,N-Dimethyl-N'-nitroguanidine 5 D1341
- 3,5-Dimethyl-4-nitro-1-nitroguanylpiprazole
5 D1342
- N,N-Dimethyl-N' (2-nitrophenyl)-urea 5 D1367

- 2,2-Dimethyl-1-nitropropane 5 D1368
- 3,5-Dimethyl-4-nitro-pyrazole 5 D1370–D1371
- Di (methyl-nitropyrazolyl)-triazene see 1,3-Bis
(3-methyl-4-nitro-5-pyrazolyl)-triazene 2 B150
- 2,7-Dimethyl-3,5-octadiyn-2,7-dihydroperoxide
5 D1121
- Di (methylol)-amine and derivs 5 D1350–D1351
di (methylol)-nitramine dinitrate
5 D1350–D1351
- Di (methylolamino)-ethane and derivs 5 D1351
N,N'-dimethylol-1,2 (or 1,4)-dinitraminoethane
5 D1351
- Dimethylolbenzene and derivs 5 D1351–D1352
X,X-dinitro-Y,Y-dimethylolbenzenes
5 D1351–D1352
- Dimethylolbutanol and derivs 5 D1352
2,2 (or 3,3)-dimethylol-1 (or 2)-butanol tri-
nitrate 5 D1352
- Dimethylolbutanone and derivs 5 D1352–D1353
3,3-dimethylol-2-butanone dinitrate 5 D1353
- Dimethylol-dimethylol-glutarate and derivs
5 D1353
(2,2-dimethylol)-dimethylol-glutarate tetra-
nitrate (or Pentaerythritol Diglycolate Tetra-
nitrate) 5 D1353
- Dimethylol-di (oxymethylene)-peroxide 5 D1353
- Di (methylol)-ethane and derivs 5 D1353–D1354
1,1 (or 1,2)-di (methylolnitrate)-2 (or 1)-
nitroethane 5 D1354
- Di (methylol)-heptanediol and derivs 5 D1354
2,6-dinitro-2,6-dimethylol-1,7-heptanediol
tetranitrate 5 D1354
- Dimethylolhexanediol and derivs 5 D1354–D1355
2,5-dinitro-2,5-dimethylol-1,1-hexanediol
tetranitrate 5 D1354–D1355
- Dimethylolmethane and derivs 5 D1355
dimethylolmethane dinitrate 5 D1355
- 1,1-Di (methylol)-methoxyethane and derivs
5 D1355
1,1-dimethylol-2-methoxy-1-nitroethane
dinitrate 5 D1355
- Di (methylol)-methylbenzene and derivs
5 D1355–D1356
1,1-di (methylolnitrate)-nitromethyl-2,5-
dinitrobenzene 5 D1355–D1356
1,1-di (methylolnitrate)-nitromethyl-3-nitro-
benzene 5 D1355
- Di (methylol)-methylenediamine and derivs
5 D1356
N,N'-di (methylol)-methylenedinitramine
5 D1356
- 1,1-Di (methylol)-1-nitropropane 5 D1358–D1359
- 1,1-Di (methylol)-1-nitropropane dinitrate
5 D1359
- Di (methylol)-oxamide and derivs 5 D1356
- Di (methylol)-oxazolidone and derivs
5 D1356–D1357
4,4-di (methylolnitrate)-3-nitro-1-oxazolidone
5 D1356–D1357
4,4-di (methylolnitrate)-1-oxazolidone 5 D1356
- Di (methylol)-peroxide-bis (hydroxymethyl)-
peroxide 5 D1357
hexamethylentriperoxyd-diamin (Ger) 5 D1357
- Di (methylol)-propane (PGc) and derivs
5 D1357–D1358
1,1-di (methylol)-1-nitropropane
5 D1358–D1359
1,1-di (methylol)-1-nitropropane dinitrate
5 D1359
2,2-di (methylol)-propane dinitrate (PGcDN)
5 D1358
- N,N'-Di (methylol)-urea and derivs 5 D1359
N,N'-bis (2,2,2-trinitroethyl)-urea 5 D1359
N-(methylol)-N'-(2,2,2-trinitroethyl) urea
5 D1359
- Dimethyloxamide and derivs (DMO)
5 D1359–D1361
N,N'-dinitro-N,N'-dimethyloxamide (DNNDMO
or MNO) 5 D1360–D1361
N,N'-dinitroso-N,N'-dimethyloxamide
(DNsoDMO) 5 D1360
- Dimethyl-oxetane and derivs 5 D1361–D1362
3,3-di (nitratomethyl) oxetane 5 D1361–D1362
3,3-di (nitromethyl) oxetane 5 D1362
- 2,4-Dimethyl-1,3-pentadienne and derivs 5 D1362
2,4-dimethyl-1,3-pentadienne peroxide 5 D1362

- Dimethylpentane and derivs 5 D1362–D1363
 dinitro-dimethylpentanes 5 D1362–D1363
 3-nitroso-3-nitro-2,4-dimethylpentane 5 D1362
- Dimethylpentanone and derivs 5 D1363
 4,4-dimethyl-5,5,5-trinitro-2-pentanone
 5 D1363
- Di (3-methylpentynyl)-3-peroxide see Acetylene
 hydroperoxides and peroxides 1 A66
- Dimethylperoxide 5 D1363
- Di (methylphenylamino)-propane see Bis (methyl-
 phenylamino)-propane 2 B150
- Di (methylphenylamino)-propane see 1,3-Bis
 (2'-methylphenylamino)-propane 2 B151
- Dimethylphenylbenzylammonium chlorate 2 C188
- N,N' -Dimethyl-m-phenylenediamine (DMPDA)
 5 D1363–D1366
 dimethyldinitro-m-phenylenediamines 5 D1364
 N,N' -dimethyl- N,N' -dinitroso-m-phenylene-
 diamine 5 D1364
 N,N' -dimethyl-4-mononitro-m-phenylene-
 diamine 5 D1364
 N^1,N^3 -dimethyl- $N^1,2,4,6$ -tetranitro-m-
 phenylenediamine 5 D1365
 N,N' -dimethyl-2,4,6-trinitro- N,N' -dinitro-
 phenylenediamine (Ditetryl)
 5 D1365–D1366
 dimethyltrinitro-m-phenylenediamines 5 D1364
- Dimethylphenylhydrazine and derivs 5 D1366
 4,6-dinitro-2,5-dimethylphenylhydrazine
 5 D1366
 trinitrodimethylphenylhydrazines 5 D1366
- Dimethylphenylurea and derivs 5 D1366
 N,N -dimethyl- N' (2-nitrophenyl)-urea 5 D1367
 N,N' -dimethyl- N -(2,4,6-trinitrophenyl)-urea
 5 D1367
- o-Dimethylphthalate (DMePh) 5 D1367–D1368
- Dimethylpropane and derivs 5 D1368–D1369
 2,2-dimethyl-1,3-dinitropropane 5 D1368
 2,2-dimethyl-1-nitropropane 5 D1368
 2,2-dimethyl-1,1,1-trinitropropanes
 5 D1368–D1369
- 2,2-Dimethyl-1,3-propane dinitrate 5 D1291
- Dimethylpropylenediamine and derivs
 5 D1369–D1370
 2,3-dimethylpropylene-1,3-diaminodiper-
 chlorate 5 D1369–D1370
 dimethylpropylene-1,3-dinitramine 5 D1369
- Di (methylpropyl)-maleate and derivs 5 D1370
 di (2-nitro-2-methylpropyl)-maleate 5 D1370
- 1,1-Dimethyl-2-propynyl-hydroperoxide see
 Acetylene hydroperoxides and peroxides 1 A66
- 1,1-Dimethyl-2-propyn-1-ol and derivs 5 D1370
 1,1-dimethyl-2-propyn-1-nitrite 5 D1370
- Dimethylpyrazole and derivs 5 D1370–D1371
 3,5-dimethyl-4-azidopyrazole 5 D1370
 3,5-dimethyl-1,4-dinitropyrazole 5 D1371
 3,5-dimethyl-4-nitropyrazole 5 D1370–D1371
- 2,4-Dimethylpyridine and derivs 5 D1371
 2,4-dimethylpyridinodiazido-copper (II)
 complex 5 D1371
- Dimethylpyridone and derivs 5 D1371
 4,6-dimethyl-3,5-dinitro-2 (1H)-pyridone
 5 D1371
- 2,6-Di (methyl)-4-pyrone 5 D1371–D1372
- 2,6-Di (methylpyrone)-methyl perchlorate
 5 D1372
- 2,4-Dimethylpyrole-3,5-dicarbonyl azide 5 D1372
- Dimethyl sebacate (DMeSeb) 5 D1372
- Dimethylsulfamide and derivs 5 D1372–D1373
 N,N' -dinitro- N,N' -dimethylsulfamide
 5 D1372–D1373
- Dimethylsulfate [rationite (Fr) or D-stoff (Ger)]
 5 D1373
- Dimethylsulfoxide (DMSO) 5 D1373–D1374
- N,N' -Dimethyltartramide and derivs 5 D1374
 N,N' -dimethyl- N,N' -dinitro-tartramide
 dinitrate 5 D1374
- Dimethyltetraazacyclooctane and derivs 5 D1374
 3,7-dinitro-1,5-dimethyl-1,3,5,7-tetraazacyclo-
 octane 5 D1374
- 4,4'-Dimethyl-1,1'-5,5'-tetranitro-2,2'-biimidazole
 5 D1329
- N^1,N^3 -Dimethyl- $N^1,2,4,6$ -tetranitro-m-phenylene-
 diamine 5 D1365

- 1,5-Dimethyl-1,2,3,4-tetrazole 5 D1374
- Di [1-methyl-tetrazolyl-5]-diazene 5 D1375
- Dimethyltoluidines and derivs 5 D1375–D1376
 N,N-dimethyldinitrotoluidines
 5 D1375–D1376
 N,N-dimethyl-2,4,6-trinitro-p-toluidine
 5 D1376
 2,4,6-trinitro-3-methylnitraminotoluene
 (Methyl Tetryl or Methyl ICE) 5 D1375
- N,N'-Dimethyltriazene 5 D1376–D1377
- Di (methyltriazolyl)-formamidine see N,N'-Bis
 (5-methyl-s-triazol-3-yl)-formamidine 2 D151
- Dimethyltriethylenetetramine and derivs
 5 D1377–D1378
 N,N'-dimethyltriethylenetetranitramine
 5 D1377
 1-methyl-N' (2-nitroxyethyl)-ethylenedinitra-
 mine 5 D1377
 1-nitroxytrimethylene-3-nitramine
 5 D1377–D1378
- Di (methyltetrazolyl)-diazene see Bis (1-methyl-
 1,2,3,4-tetrazolyl-5)-diazene 2 B151
- Di (methyltriazolyl)-formamidine see N,N'-Bis
 (5-methyl-s-triazol-3-yl)-formamidine 2 B151
- N,N'-Dimethyltriethylene-tetranitramine 5 D1377
- N,N'-Dimethyl-2,4,6-trinitro-N,N'-dinitrophenyl-
 enediamine (Ditetryl) 5 D1365–D1366
- 1,1-Dimethyl-2,2,2-trinitroethylacetate 5 D1388
- 4,4-Dimethyl-5,5,5-trinitro-2-pentanone 5 D1363
- Di (methyltrinitrophenyl)-amine see Bis (3-methyl-
 2,4,6-trinitrophenyl)-amine 2 B151
- Dimethyltrinitro-m-phenylenediamines 5 D1364
- N,N'-Dimethyl-N (2,4,6-trinitrophenyl)-urea
 5 D1367
- 2,2-Dimethyl-1,1,1-trinitropropanes
 5 D1368–D1369
- N,N-Dimethyl-2,4,6-trinitro-p-toluidine 5 D1376
- Dimethylurea and derivs 5 D1378
 1,3-dimethyl-1,3-dinitrourea 5 D1378
- N,N-Dimethyl-xenylamine see N,N-Dimethyl-
 aminobiphenyl 5 D1308
- Dim igniters 3 D16
- Dina 5 D1379
- DINA see Di (2-nitroxyethyl)-nitramine
 5 D1240–D1242
- Dinaftaliti (Rus) see coal mining expls 3 C441;
 5 D1379
- Dinamitas see Spanish Dynamites 3 C441–C442
- Dinamiti see Italian Dynamites 3 C440, C451;
 5 D1379
- Dinamiti Italiani 5 E130–E134
- Dinamity, nepredokhranitel'nyiye see Russian
 nonpermissible Dynamites 3 C441
- Dinamity predokhranitel'nyiye see Russian
 permissible Dynamites 3 C454
- Dinamoni 1° and S see Italian nonpermissible
 expls 3 C439–D440; 5 D1379
- Dinamony see Russian nonpermissible expls
 3 C441
- Dinaphthylamine and derivs 5 D1379
 hexanitro- β,β -dinaphthylamine 5 D1379
 X,X,X,X-tetranitro- β,β -dinaphthylamine
 5 D1379
- Dinaphthylazotetrazole and derivs
 5 D1379–D1380
- Dinaphthyl-succinamide see Bis (α -naphthyl)-
 succinamide 2 B151
- 1,3-Di-1-naphthyltriazene see Diazoamino-
 naphthalene 5 D1158
- Ding-dong (genie) 5 D1380
- Dinicotinic acid and derivs 5 D1380
 dinicotinic acid diazide 5 D1380
- Dinite no 1 powder 5 D1380
- 1,3-Dinitraminobenzene 5 D1130
- 1',3'-Di (2-nitramino-1,3-dinitroxypropane)-
 2',4',6'-trinitrobenzene see 1',3'-Bis (1,3-
 dinitroxy-2-nitraminopropane)-2',4',6'-
 trinitrobenzene 1 A252
- 1',3'-Di (1-nitramino-2,3-dinitroxypropane)-
 2',4',6'-trinitrobenzene see 1',3'-Bis (2,3-
 dinitroxy-1-nitraminopropane)-2',4',6'-
 trinitrobenzene 1 A252

- Di (β -nitraminoethyl)-amine see Bis (β -nitraminoethyl)-amine 2 B128
- Di (β -nitraminoethyl)-ammonium nitrate see Bis (β -nitraminoethyl)-amine nitrate 2 B128
- N,N'-Di (β -nitraminoethylnitramino)-ethane see 1,2-Bis (2'-nitraminoethylnitramino)-ethane 2 B129
- N,N'-Di (β -nitraminoethyl)-N,N'-Bis (β -nitraminoethyl)-N,N'-dinitrourea 2 B130
- 1,2-Di (2-nitramino-2-imidoazolin-1-yl)-ethane see Aminoimidazoline 1 A220
- 2,2-Di (nitraminomethyl)-1,3-propanedinitramine see 2,2-Bis (nitraminomethyl)-1,3-propanedinitramine 2 B130
- 1,1'-Dinitramino-N-nitro-dimethylamine 5 D1135
- 1,2-Dinitraminopropanes 5 D1142–D1143
- 1,3-Dinitramino-2-propanolnitrate 5 D1143–D1144
- 4,4'-Dinitramino-3,5,3',5'-tetrabromobenzaldehydeazine 2 B36
- 4,6-Dinitramino-s-triazine-2-ol see Dinitrammeline 1 A274
- 3,5-Dinitramino- α -triazole salts 5 D1149
- 1-(2,4-Dinitroanilino)-benzene-4'-diazonium nitrate 1 A421
- Dinitratoanilinopropanediols 1 A434–A435
- 3,3-Di (nitratomethyl)-butene-1 see Dimethylbutene 5 D1331
- 3,3-Di-(nitratomethyl)-oxetane 5 D1381
- 1,2-Di-(2-nitrimino)-3-nitro-1-imidazolidyl see Aminoimidazoline 1 A220
- Dinitro-, dinitroso- and dinitroxy- compds 5 D1381–D1397 (*note* - presented as separate entries next for ease of listing)
- Dinitroabietic acid 1 A3
- Dinitroacetamide 1 A17
- Dinitroacetamidoanisole 1 A17
- Dinitroacetamidodiphenylether 1 A18
- 3,5-Dinitro-2-acetamidofuran 1 A19
- Dinitroacetamidonaphthalenes 1 A20
- Dinitroacetamidophenetole 1 A20
- Dinitroacetamidophenol 1 A21
- Dinitroacetamidotoluenes 1 A22
- Dinitroacetanilides 1 A23
- Dinitroacetin 1 A33
- Dinitroacetoneitrile 1 A45
- Dinitroacetophenones 1 A48
- Dinitroacetophenoneoximes 1 A49
- Dinitroacetoxydiphenylamine 1 A51
- 2,5-Dinitro-4-acetylamido-3-triazophenol see 3-Azido-2,6-dinitro-4-acetamidophenol 1 A21
- Dinitroacetyldiphenylamine 1 A58
- Dinitroacetylenediurein or Dinitroglycoluril 1 A65–A66
- Dinitroacetylphenylhydrazine 1 A86
- 3,4 (or 4,5)-Dinitro-2-acetylpyrrole 1 A87
- 1,5-Dinitro-3-acetyl-1,3,5-triazine (TAX) see Aceto-3,5-dinitro-1,3,5-triazacyclohexane 1 A50
- Dinitroacridine 1 A94
- Dinitroacridone 1 A95
- Dinitroaminoanisoles 1 A182
- Dinitroaminoanthraquinones 1 A183
- Dinitroaminoazobenzenes 1 A185
- Dinitroaminobenzaldehydes 1 A186
- Dinitroaminobenzamides 1 A186–A187
- Dinitroaminobenzene see Dinitroanilines 1 A408–D409
- Dinitro-1-aminobenzene-arsonic acid see 3,5-Dinitro-4-aminophenylarsonic acid 1 A245
- Dinitroaminobenzoic acids 1 A189
- Dinitroaminobiphenyls 1 A191
- Dinitroaminobutanes 5 D1134
- Dinitroaminocresols 1 A194
- 2,4-Dinitro-6-amino-3-cyanophenol see 2,6-Dinitro-4-amino-3-hydroxybenzonitrile 1 A218

- Dinitroaminodiphenylamines 1 A197
- Dinitroaminodiphenylethers 1 A199
- 1,6-Dinitro-2-(aminoguanyl)-benzalamino-guanidinium-biguanidine benzalhydrazone see Benzalaminoguanidinium-1,6-dinitro-2-(aminoguanyl)-biguanidine benzalhydrazone 1 A215
- 1,6-Dinitro-2-(aminoguanyl)-biguanidine, ammonium salt and nitrate 1 A214
- 2,6-Dinitro-4-amino-3-hydroxybenzotrile 1 A218
- Dinitroaminoimidazoline see 1-Nitro-2-nitramino- Δ^2 -imidazoline 1 A220
- 5,7-Dinitro-6-aminoindazole 1 A224
- 4,6-Dinitro-2-aminomesitylene 1 A225
- Dinitroaminomethylbiphenyls 1 A229
- Dinitroaminomethyldiphenylamines 1 A230
- Dinitroaminonaphthalenes 1 A237
- Dinitroaminophenetoles 1 A240
- Dinitroaminophenols 1 A241–A244
- 3,5-Dinitro-4-amino-phenylarsonic acid 1 A245
- 2-(2',6'-Dinitro-4'-aminophenyl)-ethanol 1 A246
- 1,1-Dinitro-2-aminopropane 1 A250
- Dinitroaminopyridines 1 A255
- Dinitroaminoquinolines 1 A256
- 4,6-Dinitro-2-aminoresorcinol 1 A257
- 2, ω (or 3, ω)-Dinitro-4-aminostyrene 1 A257
- Dinitroaminothiazole see 2-Nitramino-5-nitrothiazole 1 A263
- Dinitroaminotoluenes 1 A265; 9 T320–T322
- Dinitroaminoxylenes 1 A272
- Dinitroammeline 1 A273–A274
- Dinitroanilines (DNA) 1 A408–A409
- 2,4-Dinitroanilinoacetic acid 1 A420
- Dinitroanilinoazobenzene 1 A420
- 1-(2,4-Dinitroanilino)-benzene-4'-diazonium salts 1 A421
- Dinitroanilinobenzoic acid 1 A422
- m-(2,4-Dinitroanilino)-benzotrile 1 A422
- 2-(2',4'-Dinitroanilino-N)-1-butanol 1 A422–A423
- 2-(2',4'-Dinitroanilino)-ethanol 1 A424–A425
- N-[2-(2,4-Dinitroanilino)-ethyl]-aminoethanol 1 A431
- 5,7-Dinitro-6-anilino-indazole 1 A432
- 2-(2',4'-Dinitroanilino)-isobutyric acid 1 A423
- Dinitroanilinoisovaleric acid 1 A442
- 2-(2',4'-Dinitroanilino)-2-methyl-1,3-propanediol 1 A433
- N-(2',4'-Dinitroanilino)-3-nitrophthalimide 1 A434
- Dinitroanilinophenols 1 A433
- 2-(2',4'-Dinitroanilino)-1,3-propanediol 1 A435
- Dinitroanilinopropanols 1 A436
- Dinitroanilinopropionic acids 1 A436–A437
- 5-(2',4'-Dinitroanilino)- α (or 1H)-tetrazole 1 A437
- Dinitroanilintoluenes; dinitrodiphenylmethylamines 1 A438
- 2,4-Dinitroanilino-trimethylolmethane 1 A441
- Dinitroanilinoxylenes 1 A443
- Dinitroanisaldehyde-phenylhydrazones 1 A445–A446
- Dinitroanisaldehydes 1 A444–A445
- 2-Dinitroanistic acids 1 A446–A447
- Dinitroanisoles (DNAs) 1 A448–A449
- Dinitroanisylalcohols 1 A456–A457
- Dinitroanthracenes 1 A458
- Dinitroanthrachrysones 1 A458
- 1,5-Dinitroanthraquinone-2,6-diazide see 1,5-Dinitro-2,6-diazidoanthraquinone 1 A460
- Dinitroantipyrenes 1 A472
- 3,3-Dinitroazetidine 1 A519
- Dinitroazidobenzene see Azidodinitrobenzene 2 B42
- Dinitroazido compds see Azidodinitro compds 1 A627–A643

- Dinitroazoanisole 1 A646
 Dinitroazobenzenes 1 A648
 Dinitro-*p,p'*-azobenzoic acid see *X,X'*-Dinitroazobenzene-4,4'-dicarboxylic acid 1 A651
 2,5-Dinitroazobisformamidine see Azobis (nitroformamidine) 1 A652
 Dinitroazonaphthalenes 1 A656
 Dinitroazophenetole 1 A657
 Dinitroazostilbenes 1 A659
 Dinitroazotoluenes 1 A661
 Dinitroazoxyaniline see 4,4'-Diamino-3,3'-dinitroazoxybenzene 1 A665
 Dinitroazoxyanisole 1 A665
 Dinitroazoxybenzene 1 A667
 5,5'-Dinitroazoxybenzene-3,3'-dicarboxylic acid 1 A669
 Dinitroazoxynaphthalenes 1 A670
 2,2'-Dinitro-2,2'-azoxypropane 1 A671
 Dinitroazoxytoluenes 1 A672
 Dinitrobenzaldehyde 2 B35
 Dinitrobenzaldehydeazines 2 B36
 2,6-Dinitrobenzaldehyde-4-diazoniumchloride 2 B35
 Dinitrobenzaldehyde-(2,4-dinitrophenylhydrazones) 2 B37
 Dinitrobenzaldehyde-nitrophenylhydrazone 2 B37
 Dinitrobenzaldehydeoximes 2 B36
 Dinitrobenzaldehydephenylhydrazones 2 B37
 2,6-Dinitrobenzaldehyde-picrylhydrazone 2 B38
 Dinitrobenzaldehyde-semicarbazones 2 B38
 2,6-Dinitrobenzaldehyde-(2,4,6-trinitrophenylhydrazone) 2 B38
 Dinitrobenzamide 2 B39
 3,5-Dinitrobenzamidine picrate 2 B39
 Dinitrobenzamidines 2 B39
 Dinitrobenzanilide 2 B40
 Dinitrobenzodioxan 2 B67
 2,7-Dinitrobenzofuran 5 D1183
 Dinitrobenzofuroxans 2 B68–B69
 Dinitrobenzoic acid azide 2 B70
 Dinitrobenzoic acids 2 B71–B72
 Dinitrobenzoic acid hydrazide 2 B72
 Dinitrobenzol see Dinitrobenzene 2 B46–B47; 5 D1384
 Dinitrobenzonitrile 2 B76–B77
 1,1'-Di-(*p*-nitrobenzoperoxy)-cyclohexane see 1,1-Bis (*p*-nitrobenzoyl-peroxy)-cyclohexane 2 B135
 Dinitrobenzodiazonium nitrate 2 B56
 Dinitrobenzenediazooxide 2 B59–B60
 2,6-Dinitrobenzene-4-diazo-1-oxide 2 B59
 Dinitrobenzenes 2 B46
 2,4-Dinitrobenzenesulfenamide 2 B60
 2,4-Dinitrobenzenesulfonylchloride 2 B61
 2,4-Dinitrobenzenesulfonic acid 2 B61
 Dinitrobenzenesulfonic acid 2 B62
 2,4-Dinitrobenzenethiol 2 B63
 Dinitrobenzidine 2 B64
 2,2'-Dinitrobenzidine perchlorate 2 B64
 Dinitrobenzil 2 B64
 Dinitrobenzimidazole 2 B65
 5,6-Dinitrobenzimidazolone 2 B65–B66
 Dinitrobenzonitroanilide 2 B40
 Dinitrobenzocarbazole 2 B66
 Dinitrobenzodioxan 2 B67
 2,7-Dinitrobenzofuran 5 D1183
 Dinitrobenzofuroxans 2 B68–B69
 Dinitrobenzoic acid azide 2 B70
 Dinitrobenzoic acids 2 B71–B72
 Dinitrobenzoic acid hydrazide 2 B72
 Dinitrobenzol see Dinitrobenzene 2 B46–B47; 5 D1384
 Dinitrobenzonitrile 2 B76–B77
 1,1'-Di-(*p*-nitrobenzoperoxy)-cyclohexane see 1,1-Bis (*p*-nitrobenzoyl-peroxy)-cyclohexane 2 B135
 Dinitrobenzodiazonium nitrate 2 B56
 Dinitrobenzenediazooxide 2 B59–B60
 2,6-Dinitrobenzene-4-diazo-1-oxide 2 B59
 Dinitrobenzenes 2 B46
 2,4-Dinitrobenzenesulfenamide 2 B60
 2,4-Dinitrobenzenesulfonylchloride 2 B61
 2,4-Dinitrobenzenesulfonic acid 2 B61
 Dinitrobenzenesulfonic acid 2 B62
 2,4-Dinitrobenzenethiol 2 B63
 Dinitrobenzidine 2 B64
 2,2'-Dinitrobenzidine perchlorate 2 B64
 Dinitrobenzil 2 B64
 Dinitrobenzimidazole 2 B65
 5,6-Dinitrobenzimidazolone 2 B65–B66
 Dinitrobenzonitroanilide 2 B40
 Dinitrobenzocarbazole 2 B66
 Dinitrobenzodioxan 2 B67
 2,7-Dinitrobenzofuran 5 D1183
 Dinitrobenzofuroxans 2 B68–B69
 Dinitrobenzoic acid azide 2 B70
 Dinitrobenzoic acids 2 B71–B72
 Dinitrobenzoic acid hydrazide 2 B72
 Dinitrobenzol see Dinitrobenzene 2 B46–B47; 5 D1384
 Dinitrobenzonitrile 2 B76–B77
 1,1'-Di-(*p*-nitrobenzoperoxy)-cyclohexane see 1,1-Bis (*p*-nitrobenzoyl-peroxy)-cyclohexane 2 B135

- 2,5-Di-(p-nitrobenzoperoxy)-2,5-dimethylhexane
see 2,5-Bis (p-nitrobenzoylperoxy)-2,5-dimethylhexane ester 2 B135
- 9,9'-Di-(p-nitrobenzoperoxy)-fluorene see 9,9'-Bis (p-nitrobenzoylperoxy)-fluorene 2 B135–B136
- Dinitrobenzophenone 2 B77
- Dinitrobenzophenoxazine 2 B78
- Dinitrobenzophenyltriazole 2 B78
- 4,6-Dinitro-1,2-benzoquinone-2-chlorimine 2 B85
- Dinitrobenzotriazole 2 B87
- Dinitrobenzotrifluoride 2 B89
- 5,7-Dinitrobenzene-oxadiazole see 2,6-Dinitrobenzene-2-diazo-1-oxide 2 B59
- Dinitrobenzoyl azide 2 B70
- Dinitrobenzoylchloride 2 B89–B90
- Dinitrobenzoyl hydrazide see Dinitrobenzoic acid azide 2 B72
- 3,4-Di-(p-nitrobenzoyl)-furoxan 5 D1186
- Dinitrobenzyl alcohol 2 B92
- Dinitrobenzyl alcohol nitrate 3 B92
- Dinitrobenzylamine 2 B93
- Dinitrobenzylaniline 2 B93
- Dinitrobenzylazide 2 B94–B95
- Dinitrobenzyl benzoate 2 B95
- Dinitrobenzyl cyanide 2 B96
- 2,4-Dinitrobenzyl-1,4-dinitrophenyl ether 2 B99
- N,N'-Di (3-nitrobenzylideneamino)-guanidine see N,N'-Bis (3-nitrobenzylideneamino)-guanidine 2 B136
- Dinitrobenzylideneaminophenol 2 B97
- Dinitrobenzylideneaniline 2 B97
- Dinitrobenzyl nitrate 2 B92; 5 D1385
- 2,4-Dinitrobenzyl-4-nitrophenyl ether 2 B99
- Dinitrobenzylpyridine 2 B100
- Dinitrobenzyltoluidine 2 B100
- Dinitrobibenzyl 2 B110
- Dinitrobicresol 2 B112
- 5,5'-Dinitro- α,α' -bifuryl 2 B113
- 1,6-Dinitrobiguanidine 2 B115
- 1,4' (or 1,5')-Dinitroimidazole 2 B115
- Dinitrobiphenol 2 B122
- Dinitrobiphenylcarboxylic acid 2 B125
- Dinitrobiphenyldicarboxylic acid 2 B126
- 3,3'-Dinitrobiphenyl-lead nitrate 2 B123
- Dinitrobiresorcinol 2 B127
- Dinitro-bis (ethylenediamine)-cobalt (III) nitrates see Di(ethylenediamine) and derivs 5 D1231
- N,N'-Dinitro-N,N'-bis (2,4,6-trinitrophenyl)-ethylenediamine (bitetryl or ditetryl) see Bis (anilino)-ethane and derivs 2 B131
- Dinitro-bitolyl 2 B163
- 1,5-Dinitrobiuret 2 B163; salts 5 D1385
- Dinitro-bixyl 2 B165
- Dinitrobromoaniline 2 B307
- Dinitrobromoazobenzene 2 B308
- Dinitrobromoazoxybenzene 2 B308
- Dinitrobromobenzoyl azide 2 B311
- 1,1-Dinitro-1-bromoethane 2 B311
- Dinitrobromomethane 2 B312
- Dinitrobromomethylaniline 2 B313
- Dinitrobromophenol 2 B315
- Dinitrobromoresorcinol 2 B316
- Dinitrobromotoluene 2 B316–B317
- Dinitrobutane 2 B367
- Dinitro-iso-butane 2 B368
- 1,4-Dinitro-2,3-butanediol 2 B369–B370
- Dinitrobutanol 2 B374
- Dinitrobutene 2 B376
- Dinitro-C-butylaminotoluene 2 B377
- 3,5-Dinitro-4-N-butyl-aminotoluene 2 B377
- Dinitro-C-butyl-aniline 2 B378

- Dinitro-N-butylaniline **2** B378
 Dinitrobutylanisole **2** B380
 Dinitrobutylbenzene **2** B380–B381
 Dinitrobutylcresol **2** B381
 Dinitrobutylmethylanisole **2** B386
 3,5-Dinitro-4-(N-butyl-N-nitro)-aminotoluene
 2 B377–B378
 3,5-Dinitro-4-(N-butyl-N-nitroso) aminotoluene
 2 B377
 Dinitrobutylphenol **2** B388
 Dinitrobutyltoluene **2** B388–B389
 Dinitrobutylxylene **2** B390
 Dinitrobutyric acid **2** B392
 3,3-Dinitrocadaverine **2** C2
 Dinitrocarbanilide **2** C44
 Dinitrocarbazoles **2** B47–C48
 Dinitrocellulose see Octanitrocellulose (table)
 2 C100; **5** D1386
 Dinitrocentralite **1** **2** C135
 Dinitrocentralite **2** **2** C139
 Dinitrochalcones **2** C146
 Dinitrochinchonamine **3** C322
 Dinitrochloroanilines **3** C247
 Dinitrochloroanilinopropanediols **3** C247
 Dinitrochloroanisole **3** C248
 Dinitrochlorobenzene **3** C249–C250
 Dinitrochlorobenzoic acid **3** C252
 Dinitrochlorobenzoic acid azide **3** C252
 Dinitrochlorobenzonitrile **3** D252–C253
 Dinitrochlorobromomethane **3** C259
 β -Dinitrochlorohydrin **3** C266
 Dinitrochlorohydroxyanisole **3** C257
 Dinitrochlorohydroxybenzaldehyde-(4-nitro-
 phenylhydrazone) **3** C257
 Dinitrochloroiodomethane **3** C259
 Dinitrochloromethane **3** C259
 Dinitrochloromethylaniline **3** C260–C261
 Dinitrochlorophenol **3** C262
 Dinitrochloropropane **3** C265
 Dinitrochloropyridine **3** C267
 Dinitrochlorostyrene **3** C269–C270
 Dinitrochlorotoluene **3** C271–C272
 Dinitrochloroxylene **3** C273
 Dinitrochrysene **3** C320
 Dinitrochrysenedione **3** C321
 Dinitrocinnamic acid **3** C323
 5,7-Dinitro-3-coumaranone **3** C548
 Dinitrocoumaric acid **3** C549
 Dinitrocreols **3** C557
 Dinitrocumene **3** C574
 1,2-Dinitrocyclohexane **3** C595
 2,6-Dinitrocyclohexanone **3** C597
 Dinitrocyclohexyltoluidine **3** C601
 1,3-Dinitro-cyclo-2,4,5-trimethylene-1,3-diamine
 3 C611
 Dinitrocymenes **3** C637
 Dinitroderivs (& salts) of dihydroxybenzene
 5 D1273–D1276
 Dinitrodiaminoanisoles **5** D1127
 Dinitrodiaminoanthraquinones **5** D1127
 Dinitrodiaminoazobenzene **5** D1129
 Dinitrodiaminobenzenes **5** D1130
 3,3'-Dinitro-4,4'-diaminobenzophenone **5** D1132
 Dinitrodiaminobiphenyls **5** D1133
 N,N'-Dinitro-diaminoethane **5** D1137–D1138
 N,N'-Dinitro-diaminomethane **5** D1139–D1140
 Dinitrodiaminotetramethylbenzenes **5** D1144
 Dinitro-diaminotoluenes **5** D1146
 Dinitrodianisoles **5** D1151–D1152

- 3,7-Dinitro-3,7-diaza-1,5-dioxacyclooctane
5 D1386
- 3,5-Dinitro-3,5-diazapiperidinium nitrate (PCX)
5 D1386
- 1,5-Dinitro-2,6-diazidoanthraquinone 1 A460
- 4,6-Dinitro-1,3-diazidobenzene 2 B43
- Dinitrodiazoaminobenzenes 5 D1156–D1157
- 2',4'-Dinitro-4-diazodiphenylamine see 4-(2',4'-
Dinitrophenylimino)-1-diazonium-1,4-benzo-
quinone 2 B82
- Dinitrodiazonaphthols 5 D1169
- Dinitrodiazophenol (Dinol) 2 B59; 5 D1172
- Dinitrodiazoresorcinol methyl ethers
5 D1174–D1175
- Dinitrodiazoresorcinols 5 D1174
- Dinitrodiazotoluenes 5 D1179
- eso-Dinitrodiazotoluene sulfonic acids
5 D1179–D1180
- 3,5-Dinitro-2-diazo-p-xylene salts 5 D1181
- Dinitrodibenzoyl peroxide 5 D1187–D1188
- Dinitrodibenzylamines 5 D1189
- Dinitrodibenzylmethanes 5 D1189
- Dinitrodibromobenzenes 5 D1191–D1192
- 4,8-Dinitro-2,6-dibromo-1,5-diaminoantra-
quinone 5 D1192
- 4,8-Dinitro-2,6-dibromo-1,5-dinitraminoantra-
quinone 5 D1192
- Dinitrodibromophenol 5 D1195
- 1,8-Dinitro-3,6-dicarbethoxy-3,6-diazaoctane see
1,2-Bis (2'-nitroxyethyl-ethane-diurethane)
2 B130
- 1,10-Dinitro-4,7-dicarbethoxy-1,4,7,10-tetraza-
decane see 1,2-Bis (2'-nitraminoethyl)-ethane
diurethane 2 B129
- N,N-Dinitro-N,N'-dicarboethoxyethylenediamine
5 D1202
- N,N'-Dinitro-N,N'-dicarbomethoxyethylene-
diamine 5 D1202
- 3,3'-Dinitro-5,5'-dicarboxylazoxybenzene see
5,5'-Dinitroazoxybenzene-3,3'-dicarboxylic
acid 1 A669
- Dinitrodichloroazobenzenes 5 D1204–D1205
- Dinitrodichloroazoxybenzene 5 D1206
- Dinitrodichlorobenzene, commercial (Parazol)
5 D1207–D1208
- Dinitrodichloromethane 5 D1213
- Dinitrodiethylbenzene 5 D1228
- 1,7-Dinitrodiethylenetriamine see Bis-(β -nitra-
minoethyl)-amine 2 B128
- N,N'-Dinitro-N,N'-diethylmethylenediamine
5 D1239
- Dinitro-1,3-di (ethylolamino)-benzene 5 D1242
- Dinitrodiethylol-oxamide dinitrate (NENO) see
Diethylloxamide and derivs 5 D1244
- N,N'-Dinitro-N,N'-diethylloxamide see Diethyl-
loxamide 5 D1246
- N,N'-Dinitro-N,N'-diethylsulfamide 5 D1387
- Dinitrodifluorobenzenes 5 D1259
- 4,6-Dinitro-1,3-dihydrazinobenzene see 1,3-Bis
(hydrazino)-4,6-dinitrobenzene 2 B143
- 2,4-Dinitro-3,5-dihydrazinotoluene 5 D1264
- 4,6-Dinitro-1,3-dihydroxylaminobenzene
5 D1292–D1293
- 4,6-Dinitro-3,5-dihydroxy-2-azo-benzoquinone
5 D1387–D1388
- Dinitrodihydroxybenzophenyltriazole 2 B79
- 3,6-Dinitro-2,5-dihydroxy-1,4-benzoquinone
5 D1290
- 9,9'-Dinitro-9,9'-dihydroxy-10,10'-dihydroantra-
cene see Bis (nitrohydroanthranol) 2 B144
- N,N'-Dinitro-N,N'-dihydroxyethyloxamide
dinitrate see Dinitrodiethylloxamide
dinitrate 5 D1244
- Dinitrodihydroxynaphthalenes 5 D1294
- 3,5-Dinitro-2,6-dihydroxypyridine-4-carboxylic
acid 5 D1295
- Dinitrodihydroxytoluene 5 D1296

- 1,4-Dinitrodiketopiperazine 5 D1299–D1300
- 3,5-Dinitro-2-dimethylaminobenzoic acid 5 D1308
- 3,5-Dinitro-4-dimethylaminobenzoyl azide 5 D1308
- 3,4'-Dinitro-4-dimethylaminobiphenyl 5 D1308
- 4,6-Dinitro-3-dimethylamino-4'-hydroxylaminoazobenzene 5 D1310
- 3,5-Dinitro-2-dimethylamino-4-methylaminotoluene 5 D1310–D1311
- 3,5-Dinitro-2-dimethylamino-4-methylnitraminotoluene 5 D1311
- Dinitrodimethylaminophenols 5 D1311
- 3,5-Dinitro-2-dimethylaminopyridine 5 D1312
- Dinitrodimethylanilines 5 D1317
- Dinitro-N,N-dimethylanilines 5 D1315
- Dinitrodimethylanisole 5 D1319
- 2,2'-Dinitro-2,2'-dimethylazoxyethane see 2,2'-Dinitro-2,2'-azoxypropane 1 A671
- Dinitrodimethylbenzenes 5 D1323–D1324
- Dinitrodimethylbenzoic acids 5 D1327
- 2,4- or 4,6-Dinitro-3,5-dimethylbenzylamine 5 D1328
- Dinitrodimethylbiphenyl see Dinitrobitolyl 2 B163
- 1,4-Dinitro-2,3-dimethylbutene-(2) 5 D1331
- 3,3-Dinitro-2,2-dimethylbutyric acid 5 D1332
- N,N'-Dinitro-N,N'-dimethyldiaminotartaric acid dinitrate 5 D1334
- 1,4-Dinitro-3,6-dimethyl-2,5-diketopiperazine 5 D1335
- 1,3-Dinitro-7,8-dimethylglycoluril (DNDMGU) 5 D1340–D1341
- 2,5-Dinitro-2,5-dimethylhexane 5 D1343
- 1,3-Dinitro-5,5-dimethylhydantoin 5 D1343–D1344
- Dinitrodimethylindazole 5 D1347
- N,N'-Dinitro-N,N'-dimethylmalonamide 5 D1348
- N,N'-Dinitro-N,N'-dimethylmethanediamine 5 D1348
- X,X-Dinitro-Y,Y-dimethylolbenzenes 5 D1351–D1352
- 2,6-Dinitro-2,6-dimethylol-1,7-heptanediol tetranitrate 5 D1354
- 2,5-Dinitro-2,5-dimethylol-1,1-hexanediol tetranitrate 5 D1354–D1355
- N,N'-Dinitro-N,N'-dimethyloxamide (DNDMO or MNO) 5 D1360–D1361
- Dinitrodimethoxyanilines 5 D1301–D1302
- Dinitrodimethoxybenzene 5 D1302
- X-Dinitro-3,4-dimethoxyphenylarsinic acid 5 D1304
- Dinitrodimethoxytoluenes 5 D1304
- Dinitro-dimethylpentanes 5 D1362–D1363
- 4,6-Dinitro-2,5-dimethylphenylhydrazine 5 D1366
- 4,6-Dinitro-2,5-dimethylphenyl-3-nitramine see 3,5-Dinitro-2-nitramino-p-xylene 1 A272
- N,N'-Dinitro-N,N'-dimethylsulfamide 5 D1372–D1373
- 3,7-Dinitro-1,5-dimethyl-1,3,5,7-tetraazacyclooctane 5 D1374
- N,N'-Dinitro-N,N'-dimethyl-3,5,3',5'-tetranitrobenzidine 2 B64
- Dinitrodinitraminoanthraquinones 5 D1127–D1128
- Dinitro-dinitrosobenzenes 2 B45
- N,N'-Dinitro-N,N'-di(2-nitroxyethyl)-sulfamide 5 D1246
- 1,4-Dinitro-3,6-dioxy-2,5-dimethylpiperazine 5 D1291
- Dinitrodiphenylacetylene 5 D1416
- Dinitrodiphenylamines 5 D1431–D1432
- 2,4-Dinitro-diphenylamino-4-carboxyl azide see 4-Anilino-3,5-dinitrobenzoyl azide 1 A422
- 2',4'-Dinitrodiphenylamino-4-diazonium nitrate see 1-(2,4-Dinitroanilino)-benzene-4-diazonium nitrate 1 A421

- 4,4'-Dinitrodiphenylbenzene 5 D1432
 Dinitrodiphenyldisulfide 5 D1450
 Dinitro-o-diphenylenes 5 D1451
 1,2-Dinitro-1,1-diphenylethane 5 D1452
 Dinitrodiphenylethers 5 D1452
 Dinitro- α,α' -diphenylethylene ether 5 D1458
 Dinitrodiphenylethylenes 5 D1454–D1455
 3,4'-Dinitrodiphenyl-1-ethylol 5 D1459
 Dinitrodiphenylformamidine 5 D1460
 Dinitro-3,4-diphenylfuroxan 5 D1460
 Dinitro-N,N'-diphenylhydrazine 5 D1462
 Dinitrodiphenylmethane 5 D1465
 Dinitrodiphenylmethanol 5 D1467–D1468
 Dinitrodiphenylmethylenediamine 5 D1468
 4,4'-Dinitro-diphenylnitramine 5 D1432
 N,N'-Dinitrodiphenyloxamide 5 D1470
 Dinitro-N,N'-diphenylphenylenediamine 5 D1471
 Dinitrodiphenylselenides 5 D1476
 Dinitrodiphenylsulfide 5 D1477
 Dinitrodiphenylsulfones 5 D1479
 Dinitrodiphenyltetrazoles 5 D1482
 Dinitrodiphenylthiourea 5 D1484
 Dinitrodiphenylurethane 5 D1487–D1488
 Dinitro-N,N-dipropylaniline 5 D1494–D1495
 Dinitrodipropyl succinate 5 D1500
 N,N'-Dinitro-N,N'-dipropyl-3,5,3',5'-tetranitrobenzidine 2 B64
 Dinitrodipyridylamines 5 D1502
 Dinitro-ditolylamines 5 D1514–D1515
 Dinitro-ditolyl-disulfides 5 D1515–D1516
 Dinitro-N,N'-ditolyl-hydrazine 5 D1516
 Dinitro-ditolyl-sulfide 5 D1518
 Dinitro-ditolyl-triazene 5 D1519–D1520
 Dinitro-ditolyl-ureas 5 D1520
 Dinitro- β,γ -diureylan-butane 5 D1523
 3,7-Dinitro-1,5-endoethylene-1,3,5,7-tetraza-2,4,6,8-cyclooctane see 1,5-Endoethylene-1,3,5,7-tetraza-2,4,6,8-cyclooctane (homodPT) 5 E90
 o-1-(1,1-dinitroethane) ethenylamido-oxime 6 E185
 1,2-Dinitroethane-tetracarboxylic acid tetraethyl ester 6 E151–E152
 3,5-Dinitro-4-ethoxyphenylarsinic acid 6 E194
 3,5-Dinitro-2-ethoxy-thiophene 6 E195
 1,1-Dinitroethyl-acetonitrolic acid 6 E201
 N-(2,2-Dinitroethyl)-acetamide 6 E195
 Dinitroethylaminoanisoles 6 E202–E203
 Dinitro-N-ethylaminophenols 6 E204
 Dinitro (ethylamino) toluenes 6 E335
 Dinitro-N-ethylanilines 6 E206
 N,N'-Di (2-nitroethyl)-benzidine 3 D1228
 N,N'-Dinitroethylene bis acetamide 6 E231
 Dinitro-N,N'-ethylenediglycolamide dinitrate 6 E246–E247
 Di (2-nitroethyl) ether 5 D1235
 N-2,2-Dinitroethylglycine ethyl ester 6 E296
 3,5-Dinitro-1-ethyl-2,4,6-hexahydro-1,3,5-triazine 6 E298
 2,2-Dinitroethyl hydrazine 6 E300
 2,4-Dinitro-N-ethyl-N-methyl aniline 6 E309
 Dinitroethylmethylbenzenes 6 E310
 N-2,2-Dinitroethyl-N-nitroglycine ethyl ester 6 E296
 Dinitroethylolamine see 2-Amino-2,2-dinitroethanol 1 A201
 Dinitroethylloxamide 6 E314
 2,2-Dinitro-3-ethylpentane 6 E315
 2,4-Dinitro ethylphenylacetate 6 E318
 Dinitro ethylphthalates 6 E324
 2,4-Dinitro-N-ethylpropylaniline 6 E327

- 4-(1,1-Dinitroethyl)-pyridine **6** E328
 3,5-Dinitroethylsalicylate **6** E329
 Dinitro-ethyltoluenes **6** E333
 3,N-Dinitro-N-ethyl-p-toluenesulfonamide **6** E334
 3,5-Dinitro-ethyl-p-toluene sulfonate
6 E333–E334
 Dinitroethylurethane **6** E337–E338
 4,4-Dinitro ethyl valerate **6** E339
 Dinitro-(N-ethyl)-o (or p)-xylydines **6** E341
 Dinitroglycoluril see Acetylenediurein
1 A65–A66; **5** D1389
 1,1-Dinitro-2-guanidino-ethane **6** E298
 Dinitrohydroxybenzophenyltriazole **2** B79
 4,6-Dinitro-3-hydroxy-2-diazabenzquinone
5 D1389–D1390
 3,5-Dinitro-2-hydroxy-1-diazobenzoquinone
5 D1390
 5,7-Dinitro-4-hydroxy-2-(2,4,6-trinitro-3-
 hydroxyphenyl)-benztriazole **5** D1390
 β,β -Dinitro-iso-propylamine see 1,1-Dinitro-2-
 aminopropane **1** A250
 1,3-Dinitro-2-keto-5-hydroxyhexahydropyrimi-
 dine nitrate **5** D1390
 Dinitromethoxyethoxyquinol-nitric acid,
 potassium salt of **5** D1390–D1391
 N,N-Dinitro-N-methylenediamine **5** D1143
 Di (3-nitro-5-methyl-4-hydroxyphenyl)-dimethyl-
 methane see 2,2-Bis (3-nitro-5-methyl-4-
 hydroxyphenyl)-propane **2** B152
 3,5-Dinitro-4-methyl-2-nitrimino-4-thiazoline see
 2,4-Dinitro-4-methyl-2-nitrimino- Δ^4 -thiazoline
1 A235
 3,5-Dinitro-4-methyl-nitrosobiphenyl **1** A229
 1,2-Dinitro-2-methylpropane see Dinitro-iso-
 butane **2** B368; **5** D1391
 Di (2-nitro-2-methylpropyl)-maleate **5** D1370
 3,6-Dinitro-1-methyl-1,3,6-triazacycloheptane
5 D1391
 2-(2',4'-Dinitro-naphthylnitramino)-1,3-dinitroxy-
 propane **1** A252
 3-(2',4'-Dinitronaphthylnitramino)-1,2-dinitroxy-
 propane **1** A252
 Dinitronitraminoanthraquinones **1** A183–A184
 Dinitronitraminobenzoic acids **1** A189
 Dinitronitraminocresols **1** A194
 Dinitronitraminotoluenes **1** A265
 Dinitronitraminoxylens **1** A272
 Dinitronitroanilinophenols **1** A433
 3,5-Dinitro-4-(3'-nitrobenzamido)-phenol **2** B40
 3,5-Dinitro-5-nitroso-anisole **1** A450
 Dinitro-nitroso-benzene **2** B44–B45
 2,4-Dinitro-6-nitroso-benzoic acid **2** B72
 Dinitro-nitroso-bromobenzene **2** B309
 2,6-Dinitro-N-nitroso-4-bromo-N-methylaniline
2 B313–B314
 Dinitro-N-nitroso-chloromethylaniline **3** C261
 Dinitro-N-nitroso-diphenylamine **5** D1432
 1-(2',4'-Dinitrophenoxy)-2-nitroxy-ethylol
5 D1392
 α,α' -Di-(4-nitrophenyl)-acetone **5** D1415
 2,6-Dinitrophenylamine-4-diazonium nitrate see
 1-Anilino-2,6-dinitrobenzene-4-diazonium
 nitrate **1** A421
 2',4'-Dinitrophenylamine-4-diazonium nitrate see
 1-(2,4-Dinitroanilino)-benzene-4-diazonium
 nitrate **1** A421
 2-(2',4'-Dinitrophenylamino)-1,3-dihydroxy-
 propane **1** A435
 2,4-Dinitro-phenylamino-ethyl see (2',4'-Dinitro-
 anilino)-ethanol **1** A424
 1,8-Di (4-nitrophenylazo)-2,7-dihydroxynaph-
 thalene see 1,8-Bis (4-nitrophenylazo)-2,7-
 dihydroxy naphthalene **2** B153
 N,N'-Di (4-nitrophenylazo)-glycine see N,N'-Bis
 (4-nitrophenylazo)-glycine **2** B153
 2,4-Di (4-nitrophenylazo)-5-nitro-1-naphthol
2 B153

- 9,10-Di (4-nitrophenyl)-9,10-dihydrophenazine
5 D1449
- 4,6-Dinitrophenyl-1,3-di (β -hydroxyethyl)-ether
see 1,3-Bis (2-hydroxyethoxy)-4,6-dinitro-
benzene 2 B145
- 2,2'-(4,6-Dinitro-m-phenylenedioxy)-ethanol see
1,3-Bis (2-hydroxyethoxy)-4,6-dinitrobenzene
2 B145
- 1,1-Di (p-nitrophenyl)-ethane 5 D1452
- N-(2,4-Dinitrophenyl)-glycine see 2,4-Dinitro-
anilinoacetic acid 1 A420
- 4-(2',4'-Dinitro-phenylimino)-1-diazonium-1,4-
benzoquinone 2 B82
- N,N'-Dinitrophenylpiperazines 5 D1474–D1475
- 2,2-Dinitropropyl-4,4,4-trinitrobutyrate (DNPTB)
5 D1393, D1496
- 4,6-Dinitroresorcinol-bis-(2-hydroxyethyl)-ether
see 1,3-Bis (2-hydroxyethyl)-ether 2 B145
- 3,5-Dinitrosamino- γ -s-triazole 5 D1149
- Dinitrosobenzamidine 5 D1393–D1394
- Dinitrosobenzene 2 B44
- 2,3-Dinitrosobenzoquinone-1,4-dioxime 5 D1394
- Dinitrosochloromethylaniline 3 C260
- Dinitrosochlorotoluene 3 C271
- N,N'-Dinitroso-N,N'-diethylbenzidine 5 D1228
- 1,4-Dinitrosodihydroxylaminobenzene 5 D1130
- N,N'-Dinitroso-N,N'-dihydroxylaminomethane
5 D1293
- Dinitrosodimethylbenzene 5 D1322
- X,X-Dinitroso-2,4-dimethylbenzoic acid (?)
5 D1326
- 1,5-Dinitroso-1,5-dimethylbiuret 5 D1329
- N,N'-Dinitroso-N,N'-dimethyloxamide
(DNsoDMO) 5 D1360
- Dinitrosodiphenylamines 5 D1431
- 1,2-Dinitrosoethane-tetracarboxylic acid tetra-
ethyl ester 6 E152
- 4,5-Dinitroso-2-nitro-1,3-dimethylbenzene
5 D1322–D1323
- 5,6-Dinitroso-2-nitro-1,4-dimethylbenzene
5 D1323
- Dinitrosopiperidines 5 D1490
- 6,7-Dinitro-5-(tertbutyl)-hydrindene 2 B384
- 1,4-Dinitro-1,1,4,4-tetramethylolbutane tetra-
nitrate 5 D1394
- 1,5-Dinitro-1,1,5,5-tetramethylolpentane tetra-
nitrate 5 D1394–D1395
- 1,10-Dinitro-1,4,7,10-tetrapicrylhexamethylene-
1,4,7,10-tetramine 5 D1395
- 1,7-Dinitro-1,4,7,10-tetrazadecane see 1,2-Bis
(2'-aminoethylnitramino)-ethane 2 B129
- N,N'-Di-(2 (?)-nitrotolyl)-guanidine 5 D1516
- X,X-Dinitro-2,2-p-tolylpropionic acid
5 D1517–D1518
- 1,7-Dinitro-1,4,7-triazaheptane see Bis (β -nitra-
minoethyl)-amine 2 B128
- 4,6-Dinitro-1,3,5-triazidobenzene see Benzene
and derivs 2 B43
- 5,7-Dinitro-6-(2',4',6'-trinitroanilino)-indazole
1 A432
- 1,3-Dinitro-3-(2,2,2-trinitroethyl)-guanidine
6 E298
- 4,4-Dinitro-(2,2,2-trinitroethyl)-n-valerate
6 E339
- 2,3-Dinitroxy-1-aminopropane see 1-Amino-2,3-
propanediol dinitrate 1 A251
- β,β' -Dinitroxydiethylammoniumhydroxide see
Diethylolamine and derivs D1242
- β,β' -Dinitroxydiethyl-dinitro-oxamide see
Diethyloloxamide 5 D1244
- β,β' -Dinitroxydiethyl-nitramine (DINA) see
Diethylolamine 5 D1240
- β,β' -Dinitroxydiethylnitrosamine see Diethylol-
amine 5 D1240
- Dinitroxydimethylnitramine 5 D1395
- Di (2-nitroxyethyl)-chloroamine 5 D1242
- Di (β -nitroxyethyl)-N,N'-dinitro-oxamide (NENO)
see Diethyloloxamide 5 D1244

- N,N'*-Di (2-nitroxyethyl)-ethylenedinitramine
5 D1243
- Di (2-nitroxyethyl)-nitramine 5 D1240
- Di (nitroxyethyl)-nitrosamine 5 D1240
- Di (2-nitroxy-iso-propyl)-amine nitrate 5 D1498
- Di (2-nitroxy-iso-propyl)-nitramine
5 D1498–D1499
- Dinitroxynitraminodiethane see Diethylolamine
5 D1240
- Dinitroxy (propylamine) nitrate 5 D1396
- N,N'*-Di (2-nitroxypropyl)-ethylene dinitramine
5 D1499
- N,N'*-Di (3-nitroxypropyl)-nitramine 5 D1499
- 1,7-Dinitroxy-1,3,5,7-tetramethylene-2,4,6-
triamine (ATX or NBSX) 5 D1295
- 1,9-Dinitroxy-2,4,6,8-tetranitro-2,4,6,8-tetra-
azanonane 5 D1396
- 1,5-Dinitroxytrimethylene-2,4-dinitramine
5 D1297
- 1,8-Dinitroxy-2,4,7-trinitro-2,4,7-triazaoctane
5 D1397
- Dinitrure 5 D1397
- Dinitryl 5 D1397
- Dinol see 4,6-Dinitrobenzene-2-diazo-1-oxide
2 B59
- “Dinort” rods 5 D1397
- Diocetyl adipamide and derivs 5 D1398
N,N'-Di-(1,1,1-trinitro-2-octyl)-adipamide
5 D1398
- Diocetyl adipate (DOA) 5 D1236–D1237,
D1398–D1400
- Diocetyl azelate (DOZ) see Di-(2-ethylhexyl)
azelate 5 D1237
- N,N'*-Diocetyl-p-phenylenediamine (DOPDA)
5 D1400–D1402
- Diocetyl sebacate (DOS) 5 D1402–D1403
- Di-oil 5 D1403
- Diolefine 5 D1403
- 3,5-Diol-as-triazine 5 D1403
- Diorrexine 5 D1403
- Dioxa 5 D1403
- Dioxan 5 D1403–D1404
- Dioxane, nitration of 5 D1404
- Dioxanes, monocyclic 5 D1405
- 4,6-Dioxa-1,9-nonanediol and deriv 5 D1405
2,2,8,8-tetranitro-4,6-dioxa-1,9-nonanediol
5 D1405
- Dioxatetraazapentadecane and derivs 5 D1405
3,13-dioxa-5,7,9,11-tetranitro-5,7,9,11-tetra-
azapentadecane 5 D1405
3,13-dioxa-5,7,9,11-tetranitro-5,7,9,11-tetra-
azapentadecane 5 D1405
- Dioxatetraazatridecane and derivs 5 D1405
2,12-dioxa-4,6,8,10-tetranitro-4,6,8,10-tetra-
azatridecane 5 D1405
- Dioxatriazahendecane and derivs 5 D1405
2,10-dioxa-4,6,8-trinitro-4,6,8-triazahendecane
5 D1405
- Dioxime 5 D1405
- Dioximes 5 D1405
- N-Dioxo-o-1(1,1-dinitroethane)-ethenylamido-
oxime 6 E185
- N-Dioxoethenylamidooxime 6 E185
- 4,6-Dioxo-2-iminohexahydro-1,3,5-triazine
1 A273
- 1,3-Dioxolane 5 D1405–D1406
- 1,4-Dioxo-1,2,3,4-tetrahydrophthalazin-5-carbonyl
azide 5 D1406
- 3,6-Dioxo-1,2,3,6-tetrahydro-[pyrazolo-3',4',4,5-
pyridazin]-5-carbonyl azide 5 D1406
- Dioxotetramethylenetetrazolecarboxamide and
derivs 5 D1406
- Dioxybenzene 5 D1406
- Dioxydiphenyl 5 D1406
- 1,1-Dioxy-[ditetrazolyl-(5,5')] (Ger) see
1,1-Dihydroxy-(5,5'-bis-tetrazole) 2 B148
- DIPAM see 3,3'-Diamino-2,4,6,2',4',6'-hexanitro-
biphenyl 5 D1133, DA07
- Dipenta 5 D1407

- Dipentaborylmethane 5 D1407
- Dipentaerythritol and derivs 5 D1407–D1413
 dipentaerythritol, analytical procedures 5 D1410
 dipentaerythritol hexanitrate (DPEHN) 5 D1410–D1413
 dipentaerythritol trinitrate sebacate 5 D1413
- Di (pentafluorosulfur)-peroxide see Bis (pentafluorosulfur)-peroxide 2 B152
- Di (2-pentanone)-cyanohydrazone and derivs 5 D1413–D1414
 di (5,5,5-trinitro-2-pentanone)-cyanohydrazone 5 D1413–D1414
- Diphenic acid see Biphenyldicarboxylic acid 2 B125
- Diphenyl see Biphenyl 2 B122
- Diphenoquinone and derivs 5 D1414
 tetrazido-4,4-diphenoquinone 5 D1414
- 1,2-Diphenoxy-ethane see Bis (phenyl)-ethylene-glycol ether 2 B153; 5 D1414
- Diphenyl see Biphenyl 2 B122
- N,N'-Diphenylacetamide see Acetyldiphenylamine 1 A57–58; 5 D1414
- Diphenylacetamidine and derivs 5 D1414–D1415
 N,N'-Bis (4-nitrophenyl)-acetamidine 5 D1414–D1415
- N,N-Diphenylacetoacetamide 5 D1415
- Diphenyl-acetone and derivs 5 D1415
 α,α -di-[2,4-dinitrophenyl]-acetone 5 D1415
 α,α' -di-[4-nitrophenyl]-acetone 5 D1415
- Diphenylacetonitrile and derivs 5 D1415
 nitro-diphenylacetonitrile 5 D1415
 p-nitrophenyl-phenylacetonitrile 5 D1415
- Diphenylacetylene and derivs 5 D1416
 dinitrodiphenylacetylene 5 D1416
- Diphenylamine, analytical procedures and US military specification requirements and tests 5 D1419–D1426
- Diphenylamine-4-azide 5 D1427
- Diphenylamine, diazo compds and their nitrated derivs 5 D1427
- Diphenylaminediazonium hydroxide and derivs see Anilinobenzenediazonium hydroxide and derivs 1 A421
- Diphenylamine (DPA or DPha) and derivs 5 D1416–D1440
 4-azidodiphenylnitrosamine 5 D1427
 dinitrodiphenylamines 5 D1431–D1432
 dinitrodiphenylbenzene 5 D1432
 4,4'-dinitrodiphenylnitramine 5 D1432
 dinitro-N-nitroso-diphenylamine 5 D1432
 dinitrosodiphenylamines 5 D1431
 diphenylamine, analytical procedures and US military specification requirements and tests 5 D1419–D1426
 diphenylamine-4-azide 5 D1427
 diphenylamine, diazo compds and their nitrated derivs 5 D1427
 diphenylamine-diazonium hydroxide and derivs see Anilinobenzenediazonium hydroxide and derivs 1 A921
 diphenylaminonitroso derivs 5 D1427
 1,3,6,2',3',4'-hexanitrodiphenylamine 5 D1440
 hexanitrodiphenylamines 5 D1434–D1438
 2,4,6,2',4',6'-hexanitrodiphenylamine, analytical procedures 5 D1438–D1439
 hexanitrodiphenylamine, salts of 5 D1439–D1440
 mononitrodiphenylamines 5 D1427–D1430
 4 (or p)-nitrodiphenylamine 5 D1430
 nitrodiphenylnitrosamines 5 D1430–D1431
 pentanitrodiphenylamines 5 D1434
 tetranitrodiphenylamines (TeNDPhA) 5 D1433–D1434
 trinitrodiphenylamines 5 D1432–D1433
- Diphenylamine-sulfone and derivs 5 D1440–D1441
 2,4,6,8-tetranitrodiphenylamine-sulfone 5 D1440–D1441
- Diphenylamine-sulfoxide and derivs 5 D1441
 2,4,5,7-tetranitrodiphenylamine-sulfoxide 5 D1441
- Diphenylaminocarboxylic acid see Anilinobenzoic acid 1 A421
- Diphenylaminochloroarsine 5 D1441
- Di-(phenylamino)-ethane see Bis (anilino)-ethane 2 B131

- Diphenylaminoethanol and derivs
5 D1441–D1442
β-(hexanitrodiphenylamino) ethyl nitrate
5 D1442
tetranitrodiphenylamino-N-ethanol 5 D1442
- Di-(phenyl) amino-4-guanidovaleric acid and
derivs 5 D1442–D1443
di (2,4,6-trinitrophenyl)-amino-4-guanido-
valeric acid 5 D1442–D1443
- Diphenylaminonitroso derivs 5 D1427
- Di-(phenylamino)-propane see Bis (anilino)-
propane 2 B131
- Diphenylaminopropanol and derivs 5 D1443
- Diphenylaminotetrazolium hydroxide and derivs
5 D1443
2,3-diphenyl-5-nitroaminotetrazolium
hydroxide 5 D1443
- Di (phenylazo)-amine 5 D1443–D1444
- Di (phenylazo)-cyclo-pentamethylene-diamine
see N,N'-Bis (phenylazo)-cyclo-2,3,5,6,7-
pentamethylene-1,4-diamine 2 B152; 5 D1444
- Di (phenylazo)-dihydroxynaphthalene see Bis
(phenylazo)-dihydroxynaphthalene 2 B152
- Di (phenylazo)-naphthol see Bis (phenylazo)-
naphthol 2 B153
- Diphenylazotetrazoles 5 D1444
- 2,3-Diphenyl-5-benzaminotetrazolium hydroxide
5 D1444–D1445
- 2,3-Diphenylbenzopyrylium perchlorate see
Benzopyrylium compds 2 B79
- Di (p-phenylbenzoyl)-furoxan 5 D1445
- p,p'-Diphenylbenzoyl peroxide 5 D1445
- Diphenyl-bis (4,4'-diazoniumhydroxide) see
Biphenyl-bis (4,4'-diazoniumhydroxide) 2 B125
- 1,1'-Diphenyl-5,5-bistetrazole 5 D1445
- Diphenylbromarsine 5 D1445
- Diphenylcarbamide complexes 5 D1445–D1446
bis-(diphenylcarbanyl)-ethylenediamine
5 D1445
diphenylcarbanylallylamine 5 D1445–D1446
diphenylcarbanyldiethanolamine 5 D1446
- Diphenylcarbamide complexes (cont'd)
diphenylcarbanylmonoethanolamine
5 D1446
diphenylcarbanylmorpholine 5 D1446
diphenylcarbanyl-α-naphthylamine 5 D1446
diphenylcarbanyl-β-naphthylamine 5 D1446
diphenylcarbanylpiperidine 5 D1446
- Diphenylcarbanyl azide 5 D1446
- Diphenylcarbazine 5 D1446
- Diphenylcarbazon and derivs 5 D1446–D1447
- 2,3-Diphenylcarbodiazone 5 D1447
- Diphenylcarbonate 5 D1447
- Di (N-phenylcarboxamide)-acetylene and derivs
see Bis (carboxanilide)-acetylene
2 B138; 5 D1447–D1448
dipicrylcarboxamide-acetylene 5 D1489
- Diphenylchloroarsine see DA or PA
2 C167; 5 D1448
- Diphenylcyanoarsine see DC 2 C167; 5 D1448
- Diphenylcyclopentane and derivs 5 D1448
X,X,X,-tetranitro-1,2-diphenylcyclopentane
5 D1448
- Diphenyldianthranilide and derivs 5 D1448
2,4,6,2',4',6'-hexanitrodiphenyldianthranilide
5 D1448
2,4,2',4'-tetranitrodiphenyldianthranilide
5 D1448
- 4,4'-Diphenyl-diazoaminobenzene see I, III-Bis
(p-biphenyl)-triazine 2 B136
- Diphenyldiazomethane see Biphenyldiazomethane
2 B125
- Diphenyldiazonium perchlorates 5 D1449
- Diphenyldibutylurea see Butyl centralite 2 B140
- Diphenyldicarboxylic acid see Biphenyldicar-
boxylic acid 2 B125
- Diphenyldiethylurea see Centralite 1
2 B127; 5 D1449
- 9,10-Diphenyl-9,10-dihydrophenazine and derivs
5 D1449
9,10-di (4-nitrophenyl)-9,10-dihydrophenazine
5 D1449

- Diphenyldiimide see Azobenzene
1 A646; 5 D1449
- Diphenyldiketone see Benzil 2 B64
- Diphenyldimethylurea see Centralite 2
2 B137; 5 D1449
- Diphenyleneimine see Carbazole 2 C45–C50
- 4,4'-Diphenyl-diphenylamine see Bis-(p-biphenyl)-amine 1 B136
- 4,4'-Diphenyl-dipicrylethylenedihydrazine see α,β -Bis (α -phenyl- β -picrylhydrazine)-ethane 1 B154
- Diphenyl-diquinone-3,4,3',4'-bis-diazide (4,4') see 4,4'-Bis (diazo)-3,3'-dioxy-biphenyl 2 B139
- Diphenyldisulfide and derivs 5 D1450–D1451
dinitrodiphenyldisulfide 5 D1450
mononitrodiphenyldisulfide 5 D1450
hexanitrodiphenyldisulfide 5 D1450–D1451
tetranitrodiphenyldisulfide 5 D1450
trinitrodiphenyldisulfide 5 D1450
- 1,3-Diphenyl-4-disulfonmethylene-tetrazene (1) 5 D1451
- Diphenylene and derivs 5 D1451
di (phenylene)-azotrinitromethane see p,p'-Bi-(phenyleneazo-trinitromethane) 2 B126
diphenyleneoxide see Dibenzofuran 5 D1183
dinitro-o-diphenylenes 5 D1451
X,X,X,X-tetranitro-o-diphenylene 5 D1451
- Diphenylethanes 5 D1452
1,2-dinitro-1,1-diphenylethane 5 D1452
1,1-di (p-nitrophenyl)-ethane 5 D1452
1,1-di (2,4-dinitrophenyl)-ethane 5 D1452
- Diphenyl-ether and derivs 5 D1452–D1454
dinitrodiphenylethers 5 D1452
hexanitrodiphenylethers 5 D1453–D1454
mononitrodiphenylethers 5 D1452
pentanitrodiphenylethers 5 D1452
trinitrodiphenylethers 5 D1452
- Diphenylethylene and derivs (stilbene) 5 D1454–D1457
dinitrodiphenylethylenes 5 D1454–D1455
hexanitrodiphenylethylene (HNS) 5 D1457–D1458
mononitrodiphenylethylene 5 D1454
pentanitrodiphenylethylene 5 D1456
- Diphenylethylene and derivs (cont'd)
tetranitrodiphenylethylene 5 D1455–D1456
trinitrodiphenylethylene 5 D1455
- N,N'-Diphenyl-ethylenediamine and its nitrated deriv see Bis (anilino)-ethane and derivs 2 B131–B132
- α,α' -Diphenyl-ethylene ether and derivs 5 D1457–D1458
dinitro- α,α' -diphenyl-ethylene ether 5 D1458
mononitro- α,α' -diphenyl-ethylene ether 5 D1457–D1458
- Diphenyl-ethyleneglycol ether see Bis (phenyl)-ethyleneglycol ether 2 B153
- 1,1-Diphenyl-ethylene peroxide, polymeric 5 D1458
- Diphenyl-ethylol and derivs 5 D1458–D1459
3,4'-dinitrodiphenyl-1-ethylol 5 D1459
2-nitro-1,2-diphenyl-1-ethanol 5 D1458–D1459
2-nitro-1,2-diphenyl-ethanol nitrate 5 D1459
2,4,2',4',5'-pentanitrodiphenyl-ethylol 5 D1459
- N,N'-Diphenylformamidine and derivs 5 D1459–D1460
dinitrodiphenylformamidine 5 D1460
mononitrodiphenylformamidine 5 D1459–D1460
- Diphenylfuroxan and derivs 5 D1460–D1461
Bis [3 (or 4)-nitrophenyl]-furoxans 5 D1461
dinitro-3,4-diphenylfuroxan 5 D1460–D1461
- Diphenyl-glycerylether and derivs 5 D1461
1,3-di-o-picryllycerin 5 D1461
1,3-dipicrylglycerylether- β -nitrate 5 D1461
- Diphenylglycolic ether see Bis (phenyl)-ethylene-glycol ether 2 B153
- Diphenylglycoluril and derivs 5 D1461–D1462
trinitro-7,8-diphenylglycoluril 5 D1462
- Diphenylglyoxal 2 B64
- N,N'-Diphenyl-guanidine see Bis (phenyl)-guanidine 2 B154; 5 D1462
- N,N'-Diphenylhydrazine and derivs 5 D1462–D1463
dinitro-N,N'-diphenylhydrazine 5 D1462
2,4,6,2',4',6'-hexanitrohydrazobenzene 5 D1463

- N,N'-Diphenylhydrazine and derivs (cont'd)
 2,4,6,2',4'-pentanitrohydrazobenzene
 5 D1462–D1463
 tetranitro-N,N'-diphenylhydrazine 5 D1462
- Diphenylmethane hydroperoxide
 5 D1464–D1465
- 2,3-Diphenyl-5-hydroxy-tetrazolium hydroxide
 5 D1463
- 1,5-Diphenyl-1',5'-iminobis (1,2,3,4-tetrazole)
 5 D1463
- Diphenyl-iminourea see Bis (phenyl)-guanidine
 2 B154
- Diphenylketone see Benzophenone 2 B77
- 2,3-Diphenyl-5-mercaptotetrazolium hydroxide
 5 D1463
- Diphenyl-methane and derivs 5 D1464–D1466
 azidodiphenylmethane 5 D1464
 α,α -diazidodiphenylmethane 5 D1464
 dinitrodiphenylmethane 5 D1465
 diphenylmethane hydroperoxide
 5 D1464–D1465
 mononitrodiphenylmethane 5 D1465
 2,4,6,2',4'-pentanitrodiphenylmethane
 5 D1466
 2,4,2',4'-tetranitro-diphenylmethane 5 D1466
 trinitrodiphenylmethane 5 D1465–D1466
- Diphenylmethanol and derivs 5 D1466–D1468
 dinitrodiphenylmethanol 5 D1467–D1468
 diphenylmethyl nitrate 5 D1466–D1467
 diphenylmethyl nitrite 5 D1466
 mononitrodiphenylmethanol 5 D1467
 4-nitrosodiphenylmethanol 5 D1466
- Diphenyl-methylamine and derivs 5 D1468
 2,4,6,2',4',6'-hexanitrodiphenylmethylamine
 5 D1468
- Diphenylmethylamines and derivs see Anilino-
 toluene and derivs 1 A438–A440
- Diphenylmethylenediamine and derivs 5 D1468
 dinitrodiphenylmethylenediamine 5 D1468
- Diphenylmethylenedihydroxyphenylpropane
 and derivs 5 D1469
 1,3-dipicryl-2-(3,4-methylenedihydroxy-
 phenyl)-propane 5 D1469
- Diphenylmethyl nitrate 5 D1466–D1467
- Diphenylmethylnitrite 5 D1466
- 2,3-Diphenyl-5-nitrosaminotetrazolium hydroxide
 5 D1493
- Di (phenylol)-dimethyl-methane and derivs
 5 D1469
 1,3-bis (2,4,6-trinitrophenoxy)-propane
 5 D1469
- Di (phenylol)-propane see Bis (hydroxyphenyl)-
 propane 2 B147
- Di (phenylol)-sulfone see Bis (hydroxyphenyl)-
 sulfone 2 B148
- Diphenyloxamide and derivs 5 D1469–D1470
 N,N'-bis (2,4-dinitrophenyl)-oxamide 5 D1470
 N,N'-dinitrodiphenyloxamide 5 D1470
 2,3,6,2',4',6'-hexanitrodiphenyloxamide
 5 D1470
- Di (phenyloxy)-ethylene 5 D1470
- Di [(phenyl-phenylamino)-ethylamino]-ethane
 see 1,2-Bis [(phenyl-phenylamino)-ethylamino]-
 ethane 2 B154
- Diphenylphenylenediamine and derivs
 5 D1470–D1472
 N,N'-Bis (2,4-dinitrophenyl)-2,4,6-trinitro-
 1,3-phenylenediamine 5 D1472
dinitro-N,N'-diphenylphenylenediamine
 5 D1471
 N,N'-dipicryl-5-nitro-1,3-phenylenediamine
 5 D1472
 hexanitro-N,N-diphenyl-phenylenediamine
 5 D1471
 tetranitrodiphenylphenylenediamines 5 D1471
 trinitro-N,N'-diphenylphenylenediamine
 5 D1471
- 1,4-Diphenyl-3,5-phenylimino-1,2,4-triazole
 5 D1472
- Diphenylphthalate (DPhPht) 5 D1472–D1474
 US military specification 5 D1472–D1474
- Di (phenylpicrylhydrazine)-ethane see α,β -Bis
 (α -phenyl- β -picrylhydrazine)-ethane 2 B154
- Diphenylpiperazine and derivs 5 D1474–D1475
 N,N'-bis (4-nitrosophenyl)-piperazine 5 D1474
 N,N'-bis (2,4,6-trinitrophenyl) piperazines
 5 D1475
 N,N'-dinitrophenylpiperazines 5 D1474–D1475
 N,N'-tetranitrodiphenylpiperazine 5 D1475

- Diphenylpropylenediamine see Bis (anilino)-propane and derivs 2 B132–B133
- Diphenyl-quinomethane and derivs 5 D1475–D1476
mononitrodiphenylquinomethane 5 D1475
- Diphenylselenide and derivs 5 D1476
dinitrodiphenylselenides 5 D1476
2,3,6,2',4',6'-hexanitrodiphenylselenide 5 D1476
2,4,2',4'-tetranitrodiphenylselenide 5 D1476
- Diphenylsulfide and derivs 5 D1476–D1478
dinitrodiphenylsulfides 5 D1477
2,4,6,2',4',6'-hexanitrodiphenylsulfide (HNDPhS) 5 D1477–D1478
mononitrodiphenylsulfides 5 D1476
2,4,6,2',4'-pentanitrodiphenylsulfide 5 D1477
2,4,2',4'-tetranitrodiphenylsulfide 5 D1477
trinitrodiphenylsulfides 5 D1477
- Diphenylsulfone and derivs 5 D1478–D1480
4,4'-diazidodiphenylsulfone 5 D1479
dinitrodiphenylsulfones 5 D1479
2,4,6,2',4',6'-hexanitrodiphenylsulfone (HNDPhSo) 5 D1480
mononitrodiphenylsulfones 5 D1479
2,4,2',4',6'-pentanitrodiphenylsulfone or thionol (PNDPhSo) 5 D1480
2,4,2',4'-tetranitrodiphenylsulfone 5 D1479
trinitrodiphenylsulfones 5 D1479
- Diphenyltetraacetylene 5 D1480–D1481
- Diphenyl tetraozonide see Biphenyl tetraozonide 2 B126
- I,III-Diphenyl-tetrazine (1) 5 D1481
- Diphenyltetrazole and derivs 5 D1481–D1482
dinitrodiphenyltetrazoles 5 D1482
mononitrodiphenyltetrazoles 5 D1481–D1482
- N,N'-Di (2-phenyl-5-tetrazolyl)-urea 5 D1482
- p-Diphenyltetrazonium-2,1-naphthol-sulfonate 5 D1482
- N,N'-Diphenylthiocarbazone 5 D1482–D1483
- 2,3-Diphenyl-5-thiocarbazone 5 D1483
- Di (phenylthio)-dimethylbenzene see Bis (phenylthio)-dimethylbenzene 2 B155
- 2,3-Diphenyl-5-thio-tetrazolium hydroxide 5 D1483
- Diphenylthiourea and derivs 5 D1483–D1484
N,N'-bis (3,5-dinitrophenyl)-thiourea 5 D1484
dinitrodiphenylthiourea 5 D1484
mononitrodiphenylthioureas 5 D1484
N-phenyl-s-picrylthiourea 5 D1484
- Diphenyltolylpropane and derivs 5 D1484–D1485
1,3-dipicryl-2-p-tolylpropane-2,4,6,2',4',6'-hexanitrodiphenyltolylpropane 5 D1485
- 1,3-Diphenyltriazene see Diazoaminobenzene 5 D1156, D1485
- Di (phenyltriazeno)-benzene see 1,3-Bis (phenyltriazeno)-benzene 2 B155
- Diphenyltriazole and derivs 5 D1485–D1487
5-azido-1,4-diphenyl-1,2,3-triazole 5 D1485–D1486
3,5-bis (4-nitrophenyl)-1,2,4-triazole 5 D1486
mononitrophenyl-phenyltriazoles 5 D1486
tetranitro-2,4-diphenyl-2,1,3-triazole 5 D1486–D1487
trinitro-2,4-diphenyl-2,1,3-triazole 5 D1486
- N,N'-Diphenyl-trimethylenediamine see 1,3-Bis (anilino)-propane 2 B132
- asym-Diphenylurea see Acardite 1 1 A7
- sym-Diphenylurea see N,N'-Bis (phenyl)-urea and derivs 2 B155; 5 D1487
- Diphenylurethane and derivs 5 D1487–D1488
dinitrodiphenylurethane 5 D1487–D1488
mononitrodiphenylurethane 5 D1487
2,3,2',4'-tetranitrodiphenylurethane 5 D1488
- Diphenylamine see Aminobiphenyl 1 A191
- Diphosgene see DP 2 C167
- Diphthalic acid peroxide see Bis (phthalic acid)-peroxide 2 B156
- Dipicolinic acid and derivs 5 D1488
dipicolinic acid diazide 5 D1488
di (β -picolino)-diazido-copper complex 5 D1488
- Di (picrylamino)-anthraquinone see Bis (trinitro-anilino)-anthraquinone 2 B131
- Dipicrylcarboxamide-acetylene 5 D1447

- Dipicrylethane see 2,4,6,2',4',6'-hexanitro-sym-diphenylethane 2 B111
- N,N'-Dipicryl-ethylenediamine see 1,2-Bis (2',4',6'-trinitroanilino)-ethane 2 B131
- N,N'-Dipicryl-ethylenedinitramine see 1,2-Bis (2',4',6'-trinitroanilino)-ethane 2 B131
- 1,3-Di-o-picrylglycerin 5 D1461
- 1,3-Dipicrylglycerylether- β -nitrate 5 D1461
- Dipicrylguanidine see Bis (phenyl)-guanidine 2 B154
- 1,3-Dipicryl-2-(3,4-methylenedihydroxyphenyl)-propane 5 D1469
- N,N'-Dipicryl-5-nitro-1,3-phenylenediamine 5 D1472
- Dipicrylpropylenediamine (methylene diteteryl) see Bis (anilino)-propane 2 B133
- Di (picrylthiol)-ethylbenzene see 2,4-Bis (2',4',6'-trinitrophenylthio)-1-ethylbenzene 2 B155
- Di (picrylthiol)-xylene see Bis (2,4,6-trinitrophenylthio)-dimethylbenzene 2 B155
- 1,3-Dipicryl-2-p-tolylpropane-2,4,6,2',4',6'-hexanitrodiphenyltolylpropane 5 D1485
- sym-Dipicrylurea see N,N'-Bis (2,4,6-trinitrophenylurea) 2 B156
- Dipiperidine and derivs 5 D1490
dinitrosopiperidines 5 D1490
dipiperidino-diazido-copper 5 D1490
dipiperidino-tetrazido-cuprate 5 D1490
- Diplumbic dinitroresorcinol see Lead 4,6-dinitroresorcinate 5 D1275
- Dipole moment 5 D1490–D1492
- Dipotassium acetylde 1 A79
- Dipotassium hydroazobenzeneazobenzene-dipotassium hydrazobenzene 1 A647
- Dipotassium nitroacetate 1 A27
- Dipping 5 D1492
- Dipping of cellulose in tanks see Industrial manufacture of NC 2 C102; 3 C539
- Dipropargylbutyrol-nitroform product 5 D1492
- Dipropionylperoxide 5 D1492
- Di-m-propyladipate 5 D1492–D1493
- Dipropylamine and derivs 5 D1493–D1494
di (n-propylamino)-diazido-copper 5 D1493
dipropylnitramine 5 D1493
dipropylnitrosamine 5 D1493
N,2',2',3,3,3-hexanitrodipropylamine 5 D1494
pentanitrodipropylamines 5 D1493–D1494
2,2,2',2'-tetranitrodipropylamine 5 D1493
- Di (n-propylamino)-diazido-copper 5 D1493
- Dipropylaniline and derivs 5 D1494–D1495
dinitro-N,N-dipropylaniline 5 D1494–D1495
mononitro-N,N-dipropylaniline 5 D1494
2,4,6-trinitro-N,N-dipropylaniline 5 D1495
- 3,3'-Dipropyl-5,5'-azo-1,2,4-triazole see 5,5'-Azobis (3-propyl)-sym-triazole 1 A654
- Dipropylbenzidine and derivs 5 D1495
N,N'-3,3',5,5'-hexanitro-N,N-dipropylbenzidine 5 D1495
3,5,3',5'-tetranitro-N,N'-dipropylbenzidine 5 D1495
- 5,5'-Dipropyl-3,3'-bis-triazole 5 D1495
- Dipropylbutyrate and derivs 5 D1496
2-nitropropylbutyrate 5 D1496
2,2-dinitropropyl-4,4,4-trinitrobutyrate (DNPTNBu) 5 D1496
- Di (propylenediamino)-copper (II) diazide 5 D1497
- Dipropyleneglycol and derivs 5 D1497
dipropyleneglycol dinitrate (DPGDN) 5 D1497
- Dipropyleneglycol dinitrate (DPGDN) 5 D1497
- Dipropyl ethers 5 D1497
- Di (2-propyleniminoethyl)-sulfone 5 D1497–D1498
- Dipropyl-fumarate and derivs 5 D1498
bis (2,2-dinitropropyl)-fumarate 5 D1498
- Dipropylketone see Butyrene 2 B393
- Di (propyl)-amine and derivs 5 D1498–D1499
di (2-nitroxy-iso-propyl)-amine nitrate 5 D1498
di (2-nitroxy-iso-propyl)-nitramine 5 D1498
N,N-di (3-nitroxypropyl)-nitramine 5 D1499
- Dipropylnitramine 5 D1493

- Dipropylnitrosamine 5 D1493
- Di (propylol)-amine and derivs 5 D1501–D1502
 N,N-di (2,2-dinitro-3-propylol)-amine 5 D1502
- Di (propylol)-ethylenediamine and derivs 5 D1499
 N,N'-di (2-nitroxypopyl)-ethylenedinitramine
 5 D1499
 N,N'-di (propylol)-ethylenedinitramine
 5 D1499
- N,N'-Di (propylol)-ethylenedinitramine 5 D1499
- Dipropylpentaerythritol ether and derivs 5 D1499
 dipropylpentaerythritol dinitrate 5 D1499
- Di-n-propyl-peroxide 5 D1500
- Dipropyl succinate and derivs 5 D1500
 dinitrodipropyl succinate 5 D1500
 2,2,2',2'-tetranitrodipropyl succinate 5 D1500
- Dipropyl-sulfone and derivs 5 D1500–D1501
 3,3,3,3',3',3'-hexanitropropylsulfone 5 D1501
- Dipropylureas and derivs 5 D1501
 1,1,1,1',1',1'-hexanitro-di-iso-propylurea
 5 D1501
 3,3,3,3',3',3'-hexanitro-N,N'-n-dipropylurea
 5 D1501
- Dipyridine diazido-metal complexes 5 D1502
 dipyridine cadmium (II) diazides 5 D1502
 dipyridine copper (II) diazide 5 D1502
 dipyridine nickel (II) diazide 5 D1502
 dipyridine zinc (II) diazide 5 D1502
- Dipyridylamine and derivs 5 D1502–D1503
 dinitrodipyridylamines 5 D1502
 3,5,3',5'-tetranitro (di- α -pyridylamine)
 5 D1503
 3,5,5'-trinitro-(di- α -pyridylamine)
 5 D1502–D1503
- Directed expls see Munroe-Neumann effect
 4 D442
- Direct photography see Cameras, high speed
 photographic 2 C13–C19
- Diresorcinol see Biresorcinol 2 B126–B127
- Direzione artigliesa 5 D1503
- Diripsite 5 D1503
- Dirubidium acetylide 1 A79
- Disalicylic acid and derivs 5 D1503–D1504
 5-nitrosalicylic-salicylic acid 5 D1503
- Di-salz see Dimethylammonium nitrate 5 D1313
- Disappearing carriage 5 D1504
- Disappearing target 5 D1504
- Disarm 5 D1504
- Discarding and nondiscarding sabot projectiles
 5 D1504–D1505
- Disintegrating rotating band projectiles 5 D1505
- Disk test 5 D1505–D1506
- Dislite 3 C324; 5 D1506; 6 E343
- Disodium acetylide 1 A82
- Disodium-5-nitraminotetrazole see Aminotetrazole
 1 A259
- Disol see Anisole 1 A448
- Dispenser M106 5 D1506
- Dispersed system 5 D1506
- Dispersion in detonation (and expln) see
 Detonation (and expln) . . . 4 D421–D423
- Dispersion in shooting 5 D1506–D1507
 dispersion diagram 5 D1506
 dispersion error 5 D1506
 dispersion ladder 5 D1506–D1507
 dispersion pattern 5 D1507
- Dispiro [fluorene-9,3'-s-tetroxane-6,9-fluorene]
 see 9,9'-Bis (fluorenyl)-diperoxide 2 B143
- Displacement process of manufacture of NC
 see Cordite 3 C538
- Displacement pumps 5 D1507
- Display rocket 5 D1507
- Disposal of bombs see Bombs, disposal of 2 B234
- Disposal of captured Ger warfare materials
 5 D1507
- Disposal of defective or obsolete projectiles in
 Russia 5 D1507–D1508
- Disposal of waste ammo, expls, proplnts and pyrot
 compns see Decomposition, destruction and
 disposal of ammo, expls, etc 3 D23–D25
- Destruction and disposal of expls 3 D25–D35

- Disposal slide rule 5 D1508
- Dissipation factor (of expls) 5 D1222
- Dissociation pressure 5 D1508
- Dissolving tank explosives—practical step towards eliminating 5 D1508
- Distance piece and distance wadding 5 D1509
- Distance piece or cross tube 5 D1508—D1509
- Distillation 5 D1509—D1511
- Distler, Blecher & Lopez expls 5 D1511
- Distress signals 5 D1511—D1512
- Distribution of charge in a bore hole 5 D1512
- Distyryl-benzene see Bis (styryl)-benzene 2 B156
- 1,5-Disubstituted tetrazoles 5 D1512
- Disuccinic acid peroxide see Bis (succinyl)-peroxide 2 B156; 5 D1512
- Ditch blasting for pipe line construction 5 D1512
- Ditching, agricultural see Agriculture and forestry uses of expls 1 A113; 5 D1512
- Di (5-tetrazole)-hydrazine see Bis (5-tetrazole)-hydrazine 2 B157
- Ditetrazolyl-(5,5^h) (Ger) see 5,5'-Bis (1,2,3,4-tetrazole) 2 B157
- Di (tetrazolyl-5)-dihydro-sym-tetrazine see 3,6-Bis (2H-tetrazolyl-5)-dihydro-1,2,4,5-tetrazine 2 B157
- Di [tetrazolyl-(5)]-diimide (Ger) see Azotetrazole 1 A659—A660
- N¹,N⁶-(Ditetrazolyl-5)-hexazadiene see [N¹,N⁶-Bis-(α -tetrazolyl-5)]-hexazadiene 1 A260
- (Ditetrazolyl-5)-hydrazine see Bis (5'-tetrazole)-hydrazine 2 B157; 5 D1513
- Di (tetrazolyl-5)-sym-tetrazine see 3,6-Bis (2H-tetrazolyl-5)-1,2,4,5-tetrazine 2 B158
- I,III-Di (tetrazolyl-5)-triazene see 1,3-Bis (1H-tetrazolyl-5)-triazene 2 B158
- Ditetryl see 1,2-Bis (2',4',6'-trinitro-nitranilino)-ethane 2 B131; 5 D1365—D1366, D1513
- Dithekite 5 D1513
- Dithiaethanemercarbide 6 E150
- Dithiocarbamate of ammonium 5 D1513
- Di (thiocarbamyl)-hydrazine see N,N'-Bis (thiocarbamyl)-hydrazine 2 B158—B159
- Dithiocarbonyl azide see Azidodithiocarbonic acid and derivs 1 A632
- Dithiocarbonyldiazide disulfide 5 D1514
- Dithio-hydrazo-dicarbonamide see N,N'-Bis (thiocarbamyl)-hydrazine 2 B158
- 1,2-Dithiol-ethyl (or methyl) phosphorous acid 5 A1514
- Dithizonates 5 D1514
- Di (toluidino)-propane see Bis (methylphenyl-amino)-propane 2 B151
- Ditolyl see Bitolyl 2 B163
- Ditolyl-amine and derivs 5 D1514—D1515
dinitro-ditolylamines 5 D1514—D1515
hexanitro-di-o, m, or p-ditolyl-amines 5 D1515
- Di (tolyl)-disulfides 5 D1515—D1516
dinitro-di-tolyl-disulfides 5 D1515—D1516
4,6,4',6'-tetranitro-3,3'-ditolyl-disulfide 5 D1516
- Di (tolyl)-ethylenediamine see Bis (methylphenyl-amino)-ethane 2 B150
- N,N'-Di (tolyl)-guanidine and derivs 5 D1516
N,N'-di [2 (?) -nitrotolyl] -guanidine 5 D1516
- Di (tolyl)-hydrazine and derivs 5 D1516—D1517
dinitro-N,N'-ditolyl-hydrazine 5 D1516
4,6,4',6'-tetranitro-di (m-tolyl)-hydrazine 5 D1517
- Di (tolyl)-phthalide and derivs 5 D1517
3,3-bis (3-nitro-4-methylphenyl)-phthalide 5 D1517
octanitro-3,3-di-p-tolyl-phthalide 5 D1517
- Di (tolyl)-propionic acid and derivs 5 D1517—D1518
X,X-dinitro-2,2-di-p-tolylpropionic acid 5 D1517—D1518
X,X,X,X-tetranitro-2,2-di-p-tolylpropionic acid 5 D1518

- Di (tolyl)-sulfide and derivs 5 D1518–D1519
 dinitro-ditolyl-sulfide 5 D1518
 hexanitro-ditolyl-sulfide 5 D1518–D1519
 tetranitro-ditolyl-sulfides 5 D1518
- Di (tolyl)-triazenes and derivs 5 D1519–D1520
 dinitro-ditolyl-triazene 5 D1519–D1520
- Di (tolyl)-trimethylene-diamine see Bis (methyl-phenylamino)-propane 2 B151
- N,N'-Di (tolyl)-urea and derivs 5 D1520
 dinitro-ditolylureas 5 D1520
- Di (triazacyclohexylmethyl)-ether see Bis (1,2,5-triaza-3,5-dinitro-cyclohexylmethyl)-ether 2 B159
- Ditriazole see Bis (β -sym or β -1,2,4-triazole) 2 B159
- 3,3'-Ditriazolyl-formamidine see N,N'-Bis (s-triazol-3-yl)-formamidine 2 B159
- Ditriazo-mesidine see 2-Amino-4,6-diazido-mesitylene 1 A224
- Di-triethyl lead azoaminotetrazole see 1,3-Bis (1H-tetrazolyl-5)-triazene 2 B158; 5 D1521
- Di (triethyl) lead styphnate see Bis (triethyl)-lead styphnate 2 B160
- Di (2,4,6-triisopropylbenzoyl)-furoxan 5 D1521
- Di (trimethylbenzoyl)-furoxan and derivs 5 D1521
 di (3,5-dinitro-2,4,6-trimethylbenzoyl)-furoxan 5 D1521
- Di (2,4,6-trimethylpyridino)-diazido-copper (II) 5 D1521
- 1,4-Di [N(2',2',2'-trinitroethyl)-carboxamide]-piperazine 5 D1229–D1230
- N,N'-Di (2,2,2-trinitroethyl)-ethylenediamine 5 D1235–D1236
- N,N'-Di (2,2,2-trinitroethyl)-ethyleneurea 5 D1236
- N,N'-Di (2,2,2-trinitroethyl)-hydrazine 5 D1237
- Di (2,2,2-trinitroethyl)-hydroxylamine 5 D1237
- 1,3-Di (2,2,2-trinitroethyl)-urea 5 D1254–D1255
- Di (1,1,1-trinitro-iso-butyl)-urea 5 D1200
- N,N'-Di (1,1,1-trinitro-2-octyl)-adipamide 5 D1398
- Di (5,5,5-trinitro-2-pentanone)-cyanohydrazone 5 D1413–D1414
- N,N'-Di (2,4,6-trinitrophenyl)-acetylenedicarboxamide 5 D1202
- Di (2,4,6-trinitrophenyl)-amino-4-guanidovaleric acid 5 D1442–D1443
- N,N'-Di (2,4,6-trinitrophenyl)-ethylenedinitramine (bitetryl, ditetryl or octyl) see Bis (anilino)-ethane 2 B131
- 1,3-Di (2',4',6'-trinitrophenylpropylene)-dinitramine see Bis (2',4',6'-trinitro-N-nitranilino)-propane 2 B133
- Di (trinitrophenyl)-urea see N,N'-Bis (2,4,6-trinitrophenyl)-urea 2 B156
- Dittman Dynamites (Brit) 5 D1522
- Dittmar, C.F. 5 D1522
- Dittmar's Dynamites 5 D1522
- Di (tri-fluoromethylthio)-fluorobutane 5 D1522–D1523
- X,X-Ditrocacrylene 2 C40
- Di (uranate) potassium 5 D1523
- Diurea see 4-Amino-urazole 1 A472; 5 D1523
- β,γ -Diureylen-butan and derivs 5 D1523
 dinitro- β,γ -diureylen-butan 5 D1523
- Dive bombing (glide, laser-guided, low-angle, skip and toss bombing) 5 D1523–D1524
- Dive machine-gunning 5 D1524
- Diver 5 D1524
- Diver's liquid 5 D1524
- Dividing wall in ordnance storage magazines 5 D1524
- Divine's expls 5 D1524
- Divinyl see 1,3-Butadiene 2 B365
- Divinylacetylene (DVA) 5 D1525–D1526
- Divinylbenzene (DVB) 5 D1526
- Divinyl ether (DVO) 5 D1526
- Dixyllyl see Bixyllyl 2 B164

- Dixylylamine and derivs 5 D1526–D1527
 2,4,6,2',4',6'-hexanitroxylamine 5 D1527
 2,4,6-trinitro-3,5,3',5'-tetramethyldiphenyl-
 amine 5 D1526
- DKNA see Dipotassium nitroacetate 1 A27
- DM see Chemical warfare service 2 C167
- DMBH see α,α -Dimethylbenzylhydroperoxide
 5 D1328
- DMePh see o-Dimethylphthalate 5 D1367–D1368
- DMeSeb see Dimethyl sebacate 5 D1372
- DMF see N,N-Dimethylformamide
 5 D1339–D1340
- DMGU see Dimethylglycoluril and derivs
 5 D1340–D1341
- DMPDA see N,N'-Dimethyl-m-phenylenediamine
 5 D1363–D1366
- DMSO see Dimethylsulfoxide 5 D1373–D1374
- DMW-pulver 5 D1527
- DN (Fr) 5 D1527
- DN 5 D1527
- DNA same as Dinitroanilines 1 A408–A409
- DNAns same as Dinitroanisoles 1 A448–A449
- DNB see Dinitrobenzene 2 B46–B47
- DNBAC see Dinitrobenzoic acid 2 B71–B72
- DNBzIN see Dinitrobenzyl nitrate 2 B92
- DNCB see Dinitrochlorobenzene 3 C249–C250
- DNDMGU see 1,3-Dinitro-7,8-dimethylglycoluril
 5 D1340–D1341
- DNDMO or MNO see N,N'-Dinitro-N,N'-dimethyl-
 oxamide 5 D1360–D1361
- DNEtB see 1-Ethyl-2,4-dinitrobenzene
 6 E210–E212
- DNEU see N,N'-Dinitroethylene-urea 6 E292
- DNPA 5 D1527
- DNPN 5 D1527
- DNPTB see 2,2-Dinitropropyl-4,4,4-trinitro-
 butyrate 5 D1393
- DNPTNBu see 2,2-Dinitropropyl-4,4,4-trinitro-
 butyrate 5 D1496
- DNsoDMO see N,N'-Dinitroso-N,N'-dimethyl-
 oxamide 5 D1360
- DNT/HV₂ 5 D1528
- DOA see Di (2-ethylhexyl) adipate
 5 D1236–D1237, D1398–D1400
- Dobgerat 5 D1528
- Dodecanitrocellulose see Cellulose nitrates 2 C100,
 High nitrogen nitrocelluloses C108
- DOFL see Diamond Ordnance Fuze Labs 5 D1149
- “Do-it-yourself” ammonium nitrate-fuel oil
 (ANFO) expls 5 D1528–D1529
- Dolgov bomb 5 D1529–D1530
- Domergue expl 5 D1530
- Donar 5 D1530–D1531
- Donarit 5 D1531
- Donarita see Commerical or Industrial expls
 3 C422
- Donarite 5 D1531
- DOPDA see N,N'-Dioctyl-p-phenylenediamine
 5 D1400–D1402
- Dope 5 D1531–D1532
- Doppelzunder (double igniter) 5 D1532
- Doppler effect (or principle) and its application
 for military purposes 5 D1532–D1535
- Dora or Sevastopol gun 5 D1534
- Doree, Charles 5 D1534
- Doremus, R.O. 5 D1534
- Doremus cartridge 5 D1535
- Dorfit 5 D1535
- Dormant missile (Golem) 5 D1535
- Doron 5 D1535
- Dortmund-derne versuchstrecke 5 D1535
- DOS see Di (2-ethylhexyl) sebacate 5 D1237
- DOS see Dioctyl sebacate 5 D1402–D1403

- Double-base and triple-base propolnts
5 D1536--D1539
- Double base cannon propolnts 2 C33
- Double base howitzer propolnts 2 C34, table V
- Double base mortar propolnts 2 C35, table VI
- Double base recoilless rifle propolnts 2 C35,
table VII
- Double cartridge test, Ardeer (ADC test) 5 D1539
- Double-cone mixer 5 D1539--D1540
- Double-effect powders 5 D1540
- Double lead salt of formic and nitric acids
5 D1540
- Double salt of cesium dichromate and cesium
decahydrodecaborate 5 D1540--D1541
- Double salt of lead nitroaminotetrazole and lead
stypnate 5 D1541
- Double salts of basic lead picrate with other
organic lead salts 5 D1541--D1542
- Double salts in expls 5 D1542
- Douglas powder see British permitted expls
3 C452--C453 (table)
- Douille (Fr) 5 D1542
- Dove 5 D1542--D1543
- Dowmetal 5 D1543
- DOZ see Di (2-ethylhexyl) azalate 5 D1237
- DP see Chemical Warfare Service 2 C167
- DPA or DPhA see Diphenylamine and derivs
5 D1416--D1440
- DPEHN see Dipentaerythritol hexanitrate
5 D1410--D1413
- DP powder 5 D1543
- DPhPht see Diphenylphthalate 5 D1472--D1474
- DPT (homo) 5 D1543
- DPT or DPNT see 1,5-Endomethylene-3,7-dinitro-
1,3,5,7-tetraaza-2,4,6,8-cyclooctane
5 E91--E94
- Dragon 5 D1543
- Dragon (Fr) 5 D1543
- Dragonite 5 D1544
- Dragon's breath 5 D1544
- Dragon's teeth 5 D1544
- Dranite 5 D1544
- Dreadnaught powder 5 D1544
- Drehspiegelkamera see Cameras 2 C14
- Dreyse, Johann Nicholas von 5 D1544
- Drift signals and markers 5 D1544--D1545
- Drill and practice ammo 5 D1545
- Drill booster cavities 5 D1545--D1546
- Drillingspulver 5 D1546
- Drill oil 5 D1546--D1547
- Driving (or rotating) band of an artillery
projectile (also grooves, lands, muzzle and
rifling) 5 D1547--D1549
- Drone 5 D1549
- Drone charges 5 D1549
- Drop-ignition method 5 D1549
- Drop safety of bomb test 5 D1549--D1550
- Drop safety test 5 D1555
- Drop test(s) 1 XI, XVII; 5 D1550--D1555
- Drop test for packing 5 D1555
- Drop test tower 5 D1555
- Drop weight (or impact) tests see Impact
sensitivity 1 XVII; 4 D321--D322
- Droz dov (or Drosdov), N.F. 5 D1555
- DRPC 02 5 D1555
- Drum camera see Cameras, high-speed
photographic 2 C14
- Drums, rotary (rotating) for blending (mixing) of
expls and their components 5 D1556--D1558
- Drums, rotary (rotating) for filtering
5 D1559--D1560
- Drums, rotary (rotating) for flaking
5 D1559--D1560
- Drums, rotary (rotating) for testing packing of
ammo 5 D1560

- Drying agents see Dehydrating and drying agents
3 D43
- Drying 5 D1560–D1565
- DSI 5 D1565
- DSSP 5 D1565
- D-stoff (Ger) see Dimethyl sulfate 2 C169
- DTA 5 D1565
- Du-1 Ammonal 5 D1565
- Dualine stumping powder 5 D1565
- Dualines 5 D1566
- Dubois expls 5 D1566
- Dubois-Raymond expls (Fr) 5 D1566
- Dud 5 D1566
- Duda's ballistograph see Ballistograph 2 B10
- Duds destruction 5 D1566
- Duffek, Victor, Dr 5 D1567
- Dufour's bolting cloth 5 D1567
- Dugway proving ground 5 D1567
- Duke University 5 D1567
- DUKW 1 A393; 5 D1567
- Dulcitol and derivs 5 D1567–D1568
 dulcitol hexanitrate 5 D1568
 dulcitol pentanitrate 5 D1567
 dulcitol tetranitrate 5 D1567
- Dulitz expl 5 D1568
- Dumas apparatus 5 D1568–D1569
- Dumdum bullets see Bullets, dumdum 2 B331
- Dumorite 5 D1569
- Dumping at sea of ammo, expls, proplnts and
 pyrot items 5 D1569
- Dunn, B.W. 5 D1569–D1570
- Dunneberg (Duenneberg) fabrils 5 D1569
- Duobel 5 D1570
- Duplexite 5 D1570
- Duponol 5 D1570
- DuPont & Co, Inc (E.I. duPont de Nemours & Co,
 Inc and product line) 5 D1570–D1573
- DuPont family 5 D1573
- DuPont de Nemours, E.I. (Eleuthere Irene)
 5 D1573
- DuPont, Henry B. 5 D1574
- DuPont, Irene 5 D1574
- DuPont, Lammot (1831–1884) 5 D1574
- DuPont, Lammot (1880–1952) 5 D1574
- DuPont, Pierre Samuel 5 D1574
- DuPont, William 5 D1574
- Dupre, August 5 D1574
- Duralumin 5 D1574–D1575
- Duranickel 5 D1575
- Duraplex 5 D1575
- Duration and length of flame 5 D1575
- Duration and length of flame determination
 5 D1575–D1576
- Duration time of burning of a rocket proplnt
 5 D1576–D1577
- Durchschlags-und strahlungsproben 5 D1577
- Durco 5 D1577
- Durcon 5 D1577
- Durene or Durol 5 D1577
- Durez 5 D1577
- Durichlor 5 D1577
- Durimet-20 5 D1577
- Duriron 5 D1577
- Durnford 5 D1577
- Durnford powder 5 D1577–D1578
- Duro 5 D1578
- "Durol" 5 D1578
- Dust and foreign materials 5 D1579
- Dust, burning and deflagration 4 D154
- Dust, coal and its uses see Coaldust and its uses
 3 C358

- Dust, coal, bomb see Coal dust bomb **3 C359**
- Dust, coal and firedamp explns see Coal mine explns and fires **3 C360–C367**
- Dust, coal; expln hazards from its use **3 C359**
- Dust detonation (and expln) see Detonation and expln of dusts, mists and vapors **4 D253; 5 D1578**
- Dust, explosibility of **5 D1578**
- Dust explns **5 D1578–D1579**
- Dust fuze **5 D1579–D1580**
- Dust testing of ammo **5 D1580**
- Dutch expls, ammo and weapons **5 D1580**
- Dutch stability test **5 D1580**
- Duttenhofer, Max von (1843–1903) **5 D1580**
- Duttenhofer, Max von (1877–1935) **5 D1581**
- Duttenhofer's geschutzpulver C/82 **5 D1581**
- Duttenhofer's smokeless proplnt **5 D1581**
- Duval, Clement **5 D1581**
- Duxita B **5 D1581**
- Duxite **5 D1581**
- Duxite T4 **5 D1582**
- DVA see Divinylacetylene **5 D1525–D1526**
- DVB see Divinylbenzene **5 D1526**
- DVD see Divinylether **5 D1527**
- DVS see Dehydrating value of sulfuric in mixed acids **3 D43–D44; 5 D1582**
- Dwell or pressure dwell **5 D1582**
- DXY compn **5 D1582**
- DY compn **5 D1582**
- Dymnyi porokh **5 D1582**
- Dynagex **5 D1582**
- Dynamignite or nitromagnite **5 D1582–D1583**
- Dynamics and fluid dynamics **5 D1583**
- Dynamic tensile strength of expls **5 D1583**
- Dynamite and substitutes **5 D1584–D1748**
 classification of Dynamites **5 D1594–D1595**
 description of various types (classes) of Dynamites **5 D1594–D1614**
 Dynamites and their substitutes, additional refs on **5 D1651–D1722**
 Dynamites and their substitutes; examination, including analytical procedures **5 D1616–D1650**
 Dynamites and their substitutes, list of special names **5 D1723–D1744**
 Nitroglycerin (NG) **5 D1593–D1594**
 Nitroglycol (NGc) **5 D1594**
 substitute Dynamites, and additional ref listing without compns **5 D1744–D1748**
- Dynamite heart **5 D1583**
- Dynamite industry is fading away **5 D1583**
- Dynamitron **5 D1748**

E1

E

- E (abbr) 5 E1
 "E" (expl) (Jap) 5 E1
 E-4 great enzian 5 E1
 E-4 HEXA 5 E1
 E-7 5 D1
 E-8 rocket launcher 5 E1
 E-19 (incendiary bomb, Amer) 5 E1
 E-24 (cartridge, Amer) 5 E1
 Eagle duck and eagle rifle powders 5 E1
 Eales 5 E1
 Earle & Reid 5 E1
 Earth anchor EAW-20 5 E1-E3
 Earth cratering 5 E3
 Earth cratering test 1 X; 3 C553
 Earth crustal studies 5 E3
 Earth displacement test 5 E3
 Earthquake bomb 5 E3
 Earthquake powder (Brit) 5 E3-E4
 Ease of ignition by flash test (Brit) 5 E4
 Eastern lab of the duPont Co 5 E4
 Ebarbage des poudres (Fr) 5 E4
 Ebeling, Franz 5 E4
 E-boat 5 E4
 EBW see Exploding bridgewire detonators
 4 D807; 6 E353-E354
 EBWR core alloy 5 E4
 EC Dynamite 5 E4
 Echo 5 E4
 Echo 5 E4-E5
 Eclair 5 E5
 Eclipse 5 E5
 EC-NACO 5 E5
 Economics in commercial expls 5 E5-E6
 Economic mobilization 5 E6
 Economic war potential 5 E6
 E-cord see Detonating cords 3 D104
 EC powders 5 E6-E8
 EC pulver 5 E8
 Ecrasite 5 E8-E9
 Ectijet (Amer) 5 D9
 EDAP see Ethylenedioxyamine perchlorate
 6 E247
 EDD or EDAD see Ethylenediamine dinitrate
 6 E236-E237
 Edgewood Arsenal 5 D9-E10
 Edinorog (unicom) howitzer (Russ) 5 E10
 Edmunds (expls) 5 E10
 EDNA 5 E10
 EDNA see N,N'-Dinitro-diaminoethane
 5 D1137-D1138
 EDNA see Ethylenedinitramine 6 E238-E243
 EDNAFIVE 6 E245
 EDNAFIVES 5 E10
 EDNA salts 6 E243-E244
 EDNATOLS 6 E245-E246
 EDTA see Ethylenediaminetetraazetic acid 6 E238
 EDX 5 E11
 EED's see Electro-explosive devices 5 E63-E64
 EET see Electroexplosive transducer 5 E68
 Effective calculated calorific values of proplnts
 5 E13
 Effective fragment 5 E13
 Effective oxygen see Available oxygen 1 A515
 Effectiveness or efficiency of expls 5 E13
 Effect of compression on sensitiveness of initiation
 3 C492

- Effect of crystal size and crystallographic properties of expls on explosion see Crystallization of explosives 3 C568
- Effect of explosions and table of distances for storage of explosives 5 E11–E12
- Effects of blast and shock waves of detonation produced on structures 4 D256–D257
- Effects of boundary rarefaction on impulse delivered by expl charges during detonation 4 D257
- Effects of expl properties on cratering 5 E14
- Effects of inert components on detonation 4 D257
- Effects of ionizing radiations on proplnts and of the X-irradiation of ammonia and hydrazine 5 E14
- Effects of materials on the properties of expls see Compatibility of explosives with other substances 3 C461–C462
- Effects of metallic additives on the deflagration of condensed systems 5 E14
- Effects of polymers on expls see Compatibility of explosives with other substances 3 C461; 5 E14
- Effect of replacement of air in expl charges by nonexpl liquids on detonation velocity 4 D256
- Effects of sheaths on gases from explosions in coal mines 5 E15
- Effects of temperature on explosives 5 E15
- Effects of the physical structure and the state of aggregation on the detonating capacity of expls 5 E14
- Effects produced in air, earth and water during detonation 4 D157–D258
- Effet brisant (Fr) 2 B265; 5 E15
- Effet d'eclatement (Fr) see Fragmentation tests 3 C345
- Effet Neumann (Fr) see Munroe-Neumann effect 4 D442–D454
- Effet perforant (Fr) 5 D15
- Effet utile (Fr) 1 XX
- Efficiency of proplnts 5 E15–E16
- Efficiency, thermodynamic 5 E16
- EF (poudre, Fr) 5 E11
- EFR 5 E16
- EGDME see Ethyleneglycol dimethylether 6 E255
- EGDN, EGcDN or NGc see 5 E259–E279
- Egelit 5 E16
- Egg for manipulation of acids 1 A88
- EGGN see Ethyleneglycolglucoside nitrate 6 E256
- Egoutage des poudres (Fr) 5 E16–E17
- Ehrhardt 5 E17
- EI 5 E17
- Eimite (expl) 5 E17
- Eindrahtzunder (Ger) 5 E17
- Einfachezunder (Ger) 5 E17
- Einheitspulver (EP, Ger) 5 E17
- Einheitspulver (EP) 5 E17
- Einheitspulver R61 5 E17
- Einheitsverbindungen (Ger) see Clathrates and other inclusion compds 3 C327
- Einmann U-boat (Ger) 5 E17–E18
- Eisler (poudre) 5 E18
- Eismine 42 oder flascheneismine 5 E18
- EJB 5 E18
- EJC 5 E18
- EJE 5 E18
- EJ (proplnts) 5 E18
- Ejecta 5 E19
- Ejecting projectiles (Ger) 5 E19
- Ejector 5 E19
- EJX 5 E18–E19
- Ekrasit 5 E19
- EL-389A, EL-389B, EL-389C 5 E19
- Elastic detonation wave 4 D684

- Elasticity and Young's modulus of elasticity
5 E19–E20
- Elayl 5 E20
- “Elcord” seismic delay units of duPont Co 5 E20
- Electret 5 E20
- Electric 5 E20
- Electric aerial burst fuzes 5 D20–E22
- Electrical blasting caps (electric commercial detonators) 4 D737–D742; 5 E25
- Electrical charge formation in handling anhydric flammable liquids 5 E22
- Electrical chronographs used for velocity measurements of projectiles 5 E22
- Electrical chronographs used for velocity of detonation measurements 5 E22
- Electrical clock of Wheatstone, improved by Hipp 5 E22
- Electrical conductivity see Conductivity, electrical 3 C497
- Electrical conductivity in detonation products 4 D339 (Ref 72)
- Electrical detonators used in Italian mining industry. Protection against static electricity 5 E30
- Electrical effects of shock waves 5 E18
- Electrical engineering 5 E22–E23
- Electrical equipment in explosion-exposed installations 5 E30
- Electrical explosions 5 E23
- Electrical firing properties of some lead compds of hydrobenzene derivs 5 E23
- Electrical firing properties of some lead compds of nitrated resorcinol 5 E23
- Electrical fuses 5 E30
- Electrically conductive hose “custom flex” and conductive film “custom velostat” 5 E23–E24
- Electrically exploding wire detonators see Exploding bridgewire (EBW) detonators 4 D807–D810
- Electrically initiated expl devices, bridgewire welding for 5 E27
- Electrically produced nitroexplosives 5 E24
- Electrical measurements in reaction zones 5 E24
- Electrical probe technique for measurement of detonation and deflagration 4 D341
- Electrical transducer studies of initiation of liq expls 4 D339
- Electrical units 5 E24
- Electric and percussion primer combination 4 D795
- Electric atomization 1 A505 see Atomization 1 A505–A506
- Electric blasting cap, US military 4 D806–D807
- Electric blasting caps and radio frequency energy 5 E25
- Electric bomb fuzes of WWII (Ger) 5 E25–E27
- Electric bomb and pyrotechnic fuzes 5 E27
- Electric delay detonators (US military) 5 E28
- Electric delay primers (US military) 5 E28
- Electric detonation wave 4 D684
- Electric detonators (industrial) 5 E28
- Electric detonators, low-firing energy (industrial) 5 E24–E25
- Electric detonators, military (except fuzes) 4 D803
- Electric detonators, military (fuzes) 4 D846–D860; 5 E29
- Electric detonators, primers and blasting caps 5 E29–E30
- Electric detonators (US military) 5 E29
- Electric exploders or blasting machines 2 B212; 5 E30
- Electric firing techniques 5 E30
- Electric fuze 5 E30–E31
- Electric fuze detonators 4 D846–D850
- Electric fuze for Ger projectile 5 E31–E32
- Electric fuze primers 4 D854–D856

- Electric igniters and primers (industrial) see
Nonmilitary igniters and primers 4 D733–D737
- Electric igniters, military (Ger) 5 E32
- Electric igniter M59 for use in pyrotechnics
4 D761
- Electric igniter-primer M74 4 D1066–D1067;
5 E32
- Electric indicators 5 E32
- Electric initiating devices of duPont Co
5 E32–E33
- Electric initiating device of Zebree 5 E33
- Electric initiators, activated 5 E33
- Electric initiators of Atlas Chemical Industries
5 E33–E34
- Electric instruments 5 E34
- Electricity, extraneous, and hazards associated
with it 5 E35–E55
description of methods used for evaluating
electrostatic charges and sensitivities of
expls to electrostatic discharges 5 E39–E52
introduction to 5 E35–E36
types of extraneous electricity 5 E36–E39
- Electricity in blasting; history 5 E34–E35
- Electric matches for use in pyrotechnics 4 D761
- Electric powder 5 E55
- Electric primer comparison with percussion
primer 4 D794
- Electric primers (Ger military) 5 E55–E56
- Electric primers (US military) 5 E56–E57
- Electric primers, wireless 5 E57
- Electric proximity fuze (Ger) 5 E57–E58
- Electric purification of nitrocellulose 5 E58
- Electric squibs 5 E58–E60
- Electric time fuze (ETF) 4 D881
- Electric torpedoes 5 E60
- Electrochemical nitrations 5 E61
- Electrochemistry, electrochemical engineering,
electroanalysis and electrodecantation
5 E61–E62
- Electrochromatography 3 C294
- Electrode 5 E62
- Electrodynamics 5 E63
- Electrodynamometer 5 E63
- Electroendosmosis 5 E63
- Electro-explosive devices (EED's) 5 E63–E64
- Electro-explosive devices (EED's); operational
safety 5 E64–E65
- Electro-explosive devices (EED's); pulse firing of
5 E65
- Electro-explosive devices (EED's); sensitivity
electrostatic 5 E65
- Electro-explosive devices (EED's), testing of
5 E65–E66
- Electro-explosive devices (EED's), testing of,
non-destructive 5 E66–E68
- Electro-explosive devices (EED's); thin film bridge
for 5 E68
- Electroexplosive transducer (EET) 5 E68
- Electroforming 5 E68
- Electroluminescence 5 E68
- Electrolysis 5 E68–E69
- Electrolyte 5 E69
- Electrolytic cell 5 E69
- Electromagnet 5 E69
- Electromagnetic cannon 5 E69–E70
- Electromagnetic field, detonation wave in 4 D729
- Electromagnetic field hazard simulated
5 E70–E71
- Electromechanical fuze see Mechanical fuze
4 D882
- Electron, atom, atomic number, atomic wt,
electronic shell, element, ion, isotope, mass
number, molecule, neutron, proton and valence
5 E71–E72
- Electron 5 E72
- Electron-beam welding 5 E72
- Electron diffraction 5 E72

- Electronic flash lighting high speed photography 5 E72–E73
- Electronic fuze see Electric fuze 4 D881
- Electronic power pack 5 E73
- Electronics 5 E74
- Electronic time fuze 5 E74–E75
- Electronites (Brit) 5 E75
- Electron microscope and electron microscopy 5 E75–E77; see Microscopy 8 M126–M130
- Electrons' and neutrons' action on expls 5 E77; see Radiation effects on expls, proplnts and pyrots 9 R5–R75
- Electron theory of matter 5 E77–E78
- Electron tube 5 E78
- Electron tube chronographs 5 E78–E79
- Electroosmosis and water purification 5 E79
- Electrophoresis 5 E79–E80
- Electroscope 5 E80
- Electrostatic and electrostatics 5 E80
- Electrostatic capacity 5 E80
- Electrostatic discharges and sensitivity of explosives to initiation by them 5 E38–E55
- Electrostatic elimination 5 E81
- Electrostatic law of Coulomb 5 E81
- Electrostatic precipitation 5 E81–E83
- Electrostatic sensitivity of EED's 5 E83–E84
- Electrostatic separation and electrostatic concentration 5 E84
- “Elefant” (elephant, Ger) 5 E84
- Elektra (Ger) 5 E84
- Elektron 5 E84
- Elektronbombe (Ger) 5 E84
- Elektronmetall staub 5 E84–E85
- Elements, delay in fuze detonators and fuze primers 4 D856–D863, D866–D867
- Eleostearic acid 5 E85
- Elephant brand gunpowder (Brit) 5 E85
- Ellagitannic acid 5 E85
- Eluant 5 E85
- Elutriation 5 E85–E86
- Elvanol 5 E86
- Elvax 5 E86
- Emerald powder (Brit) 5 E86
- Emilite 5 E86
- Emission spectrometry, spectrography, spectroscopy, and spectrochemical analysis 5 E86–E87
- Emmens acid 5 E87
- Emmensite 5 E87
- Emodin (1,3,8-trihydroxy-6-methylanthraquinone) and derivs 5 E87
2,4,5,7-tetranitro-1,3,8-trihydroxy-6-methylanthraquinone 5 E87
- Empfindlichkeit 5 E87
- Empire powder (Brit) 5 E87
- Emulsification, emulsion foaming and foam 5 E87–E88
- Emulsifiers (and agents) 5 E88
- Emulsified NG and NC expl 5 E88–E89
- Emulsifiers in preparation of solventless NG proplnts 5 E89
- Emulsion as an expl 5 E89
- EMW 5 E89
- “en” 5 E89
- Encapsulants, unconventional 5 E89
- Encapsulation of hazardous materials by ultrasonic welding 5 E89
- Enclosure (or inclusion) components see Clathrates . . . 3 C327
- Endecacellulose nitrate see Endecanitate 2 C100
- End effect in detonation 4 D264
- End effect in detonation wave 4 D684; 5 E89
- End effect in rockets 5 E89

- Endoethylene-tetraaza-cyclooctane and derivs
5 E90
1,5-endoethylene-3,7-dinitro-1,3,5,7-tetraaza-
2,4,6,8-cyclooctane 5 E90
- Endoethylidene-tetraaza-cyclooctane and derivs
5 E90
1,5-endoethylidene-3,7-dinitro-1,3,5,7-tetraaza-
2,4,6,8-cyclooctane 5 E90
- Endomethylene-tetraaza-cyclooctane and derivs
5 E90–E94
1,5-endomethylene-3,7-dinitro-1,3,5,7-tetraaza-
2,4,6,8-cyclooctane (DPT or DNPT)
5 D91–E93, E94
1,5-endomethylene-3,7-dinitroso-1,3,5,7-
tetraaza-2,4,6,8-cyclooctane 5 E90–E91
- Endosmosis 5 E94
- “Energia” and “stream” rifle launched HEAT
grenade 5 E94
- Energie (Fr) 5 E94
- Energie (Ger) 5 E94
- Energiegehalt (Ger) 5 E94
- Energies, activation see Activation energies 1 A101
- Energit and tri-westfalit 5 E94–E95
- Energit A 5 E95
- Energy (atomic, chemical, expl, kinetic,
mechanical, potential, radiant, specific) 5 E95
- Energy, available in detonation and expln) see
Detonation power 4 D476
- Energy content and work performed 5 E97
- Energy content of expls 5 E95–E96
- Energy content of expls and proplnts 5 E96–E97
- Energy content of proplnt charge 5 E97
- Energy, critical, of impact in detonation 4 D198
- Energy equation 5 E98
- “Energy exchange in shock and detonation wave”
5 E98
- Energy (kinetic) of the gaseous products of expln
5 E98
- Energy measurements in expln of primers 5 E98
- Energy of recoil 5 D98–E99
- Energy relationships in detonation 4 D266
- Energy (relative) of shock wave produced by
charges fired under water 5 E99
- Energy (relative) release during Susan test for
ignition of expls by impact 4 D266
- Energy sources 5 E99
- Energy vs velocity of deflagration of colloidal
proplnts 5 E99
- Enfield rifle 5 E99
- Engels 5 E99–E100
- Engin a fumee chaude de Berger (Fr) 5 E100
- Engin a fumee froid de Verdier (Fr) 5 E100
- Engin autopropule 5 E100
- Engin criminel (Fr) 5 E100
- Engine 5 E100
- Engineering 5 E100
- Engineering test 6 E352
- Engineer’s special blasting caps 5 E100
- Engineer’s special detonator 5 E100–E101
- Engin (Fr) 5 E100
- Engin sol-sol (Fr) 5 E100
- English military Ammonals 1 A290
- English service expl 5 E101
- Engraving 5 E101
- Enheptin see 2-Amino-5-nitrothiazole 1 A263
- ENIAC 5 E101
- Ennayaku 5 E101
- Enneaheptite see Anhydroenneaheptitol 1 A404
- Enneanitrocellulose 2 C100
- Enols 5 E101–E102
- Entac (Fr) 5 E102
- Entac (Fr) 5 E102
- Entflammungsprobe 5 E102
- Enthalpy 5 E102
- Enthalpy changes 5 E102

- Enthalpy excess in detonation 4 D267
- Entkupferungsmittel (Ger) see Decoppering agent
3 D36
- Entlastungszunder (EZ44) 5 E102
- Entoyaku 5 E103
- Entropy 5 E103
- Entwässerung (trocknung) (Ger) 5 E103
- Entzündlichkeit (Ger) 5 E103
- Entzündungsgemisch (Ger) 5 E103
- Entzündungsprobe (Ger) 5 E103
- Entzündungspunkt (Ger) 5 E103
- Enveloped (blanketed or covered) expls
5 E103–E104
- Enzian E-4 5 E104
- Enzian rakete 5 E104
- EODT 5 E104
- EP see Einheitspulver 5 E17
- EPF 5 E104
- epi 5 E104
- Epichlorohydrin and derivs 5 E104–E105
epichlorohydrin, nitrated deriv 5 E105
epichlorohydrin perchlorate 5 E105
epichlorohydrin resins 5 E105
- EPOMA 5 E105
- “Eponite” 100 5 E105
- “Epon” resins 5 E105–E106
- Epoussetage (Fr) 5 E106
- Epoxides 5 E106
- Epoxies 5 E106
- Epoxy 5 E106
- 2,3-Epoxy-2-ethylhexanol 5 E106
- 2,3-Epoxy-1-propanol 5 E106
- Epoxy resins 5 E106–E107
- Epoxytriazole 5 E107
- Epreuve d'Abel 1 VII, A2
- Epreuve d'Abel ou epreuve anglaise (Fr) 1 A42
- Epreuve a la bombe ou essai de poudre en vase clos
5 E108
- Epreuve a la Dynamite de pilotis (Fr) 5 E108
- Epreuve a la resistance totalisee see Resistance to
heat test 1 XXI
- Epreuve allemande (Fr) see 132° Ger test 1 XV
- Epreuve au bloc de plomb de Trauzl see Trauzl
test 1 XXV; 5 E107–E108
- Epreuve au choc des balles see Bullet impact
sensitivity test 1 IX; 2 B333–B334; 5 E108
- Epreuve au chock de mouton (Fr) 1 XVII
- Epreuve de combustion ou de l'aptitude a
l'inflammation (Fr) 1 X
- Epreuve de finesse des cotonpoudres
5 E108–E109
- Epreuve de la resistance a la chaleur (Fr) 1 XXI
- Epreuve de premier rouge see Resistance to heat
test 1 XXI
- Epreuve de resistance a la chaleur see Resistance to
heat test 1 XXI
- Epreuve de resistance a l'exsudation (Fr) see
Exudation test 1 XI
- Epreuve des petits plombs ou epreuve au blocs
de Hess see Compression tests for determi-
nation of brisance 3 C492; 5 E109
- Epreuve de travail specifique 1 XX
- Epreuve de tu au mortier or essai au mortier
eprouvette (Fr) 1 XIX see Ballistic mortar test
2 B6
- Epreuve ou essai (Fr) 5 E107
- Epreuves de securite 5 E110
- Epreuves de stabilite des explosifs et des poudres
5 E110
- Eq S expls 5 E111
- Equations of state applicable to detonation
products of condensed expls 4 D270–D271
- Equations of state (detonation and expln),
listing of: Abel, Allan, Beattie-Bridgeman,
Becker, Becker-Kistiakowsky-Wilson, Benedict-
Webb-Rubin, Berthelot, Boltzman, Brinkley-
Wilson, Caldirola & Paterson, Callendar,

- Equations of state (detonation and expln), listing of (cont'd): Clausius, Constant- β & constant- γ , corner, Cottrell-Paterson, covolume, Deal polytropic, Dieterici, Eyring, Fickett, Furth, general, Gruneisen, Halford-Kistia-Bousky-Wilson, Hirschfelder & Roseweare, Hirschfelder-Stevenson-Eyring, Hugoniot and Rankine-Hugoniot, intermolecular, introduction, Jaffe, Jones and Jones-Miller, Keyes, Kihara & Van der Waals, Lambourn, Virial, Wilkins, Wohl, Zel'dovich & Kompaneets 4 D271–D295
- Equations of state, detonation 4 D268–D298; 5 E111
- Equations of state, exptl data, interpretation of 4 D299
- Equivalent weight 5 E111
- Equivalent weight and volume and their precision indexes for comparison of expls in air 5 E111–E112
- Ercole Dynamine 5 E112
- Erdstuka (Ger) 5 E112
- Erg 5 E112
- Erhardt 5 E112
- Eriksen's military Dynamite 5 D1609, E112
- ERL polar PE 5 E112
- Erlenmeyer, R.A.K.E. 5 E112
- Erosionless priming 5 E120–E121
- Erosion of ground; control by expls see Agriculture and forestry uses of expls 1 A113
- Erosive burning of proplnts 5 E121
- Ersatzdynamit (Ger) 5 E121
- Ersatzgeschoss (Ger) 5 E121
- Ersatzsprengstoffe (Ger) 5 E121–E122
- Erupterite 5 E123
- Erythranediol dinitrate 5 E123
- Erythrene see Butadiene 2 B365
- Erythrite 5 E123
- Erythritol (ER) and derivs 5 E123–E125
erythritol dinitrate (ErDN) 5 E123–E124
erythritol tetranitrate (ErTeN) 5 E124–E125
- E-salz (Ger) 5 E125
- Escales, Richard, Dr 5 E125
- Escales and Novak's expl 5 E125
- Eschbachzunder oder verzogerungszunder eschbach 5 E125
- Eschka mixture 5 E126
- Esclangon, Ernest 5 E126
- Eso 5 E126
- Esop's test for efficiency of detonators 1 XI; 5 E126
- ESP 5 E126
- Espadon 5 E126
- Esparto grass 5 E127
- Esparto wax 5 E127
- Espir powder 5 E127
- Esplosioni (Ital) 5 E127
- Esplosivi (Ital) 5 E127
- Esplosivi o esplodenti italiani 5 E127
- Esplosivi italiani 5 E127–E130
- Essai a la friction 5 E136
- Essai au clou (Fr) 1 XIX; 8 N1
- Essai au mortier eprouvette 5 E136
- Essai au pendule balistique 5 E136–E137
- Essai dans la terre see Cratering effect tests 3 C554
- Essai de deflagration 5 E135–E136
- Essais des amorces (Fr) 1 XVIII
- Essais d'explosifs (Fr) 5 E137–E140
combustion en gouttiere de 20mm 5 E138
combustion en tas conique 5 E138–E139
coubre de compressibilite des explosifs solides 5 E139
densite de tassement 5 E137
exsudation par etuvage 5 E138
reprise d'humidite de l'explosif en vrac 5 E137

Essais d'explosifs (Fr) (cont'd)

- reprise d'humidite en atmosphere saturee d'eau des explosifs encartouches 5 E137–E138
- sensibilite a l'amorce 5 E140
- sensibilite au choc du gros mouton de 30kg 5 E139
- sensibilite au choc du petit mouton 5 E139
- transmission de la detonation a distance 5 E140
- transmission de la pression dans un explosif pulverulent 5 E139–E140
- travail specifique relatif 5 E140
- vitesse de detonation mesuree par la methode de Dautriche 5 E140

Essence C 5 E140

Essence de mirbane (Fr) see Nitrobenzene 2 B45

Essigother (Ger) 5 E140

Essigsauere (Ger) 5 E140

Esso flame thrower 5 E141

"Essolube" 5 E141

Essons poudre 5 E141

Essons potassium chlorate gunpowder 5 E141

"Essowax" 5 E141

Essorage 5 E141

"Estane" 5 E141

Ester and esterification 5 E141

Esters, aliphatic 5 E141

Esters, nitric, liq 5 E141

Esters, nitric of polyhydroxycarboxylic acids 5 E141

Etagenguss (Ger) 6 E142

Etching reagent explodes 6 E142

ETF see Electric time fuze 4 D881

Ethanamide see Acetamide 1 A16

Ethanamidine see α -Amino- α -imidoethane 1 A223

Ethane and derivs 6 E142–E150

- ethane azide 6 E142
- ethane, azidochloro see Chloroethane 3 C254
- ethane azidonitrate 6 E142–E143
- ethane diazides 6 E143
- ethane nitrated and nitrosated derivs 6 E143–E150

Ethanemercarbide and derivs 6 E150–E151

- dichloroethanemercarbide 6 E150
- dichloroethanemercarbide diammoniate 6 E150
- dithiaethanemercarbide 6 E150
- ethanemercarbide dichlorate 6 E150
- ethanemercarbide dichromate 6 E150
- ethanemercarbide dinitrate 6 E150
- ethanemercarbide diperchlorate 6 E151
- ethanemercarbide dipicrate 6 E151
- ethanemercarbide disulfate 6 E150
- ethanemercarbide hexachloride 6 E150
- ethanemercarbide hexaiodide 6 E150

Ethanenitrile see Acetonitrile 1 A43

Ethanephosphorous acid, esters 6 E151

Ethanetetracetic acid and derivs 6 E151

- ethane-1,1,2,2-tetracetic acid hydrazide 6 E151

Ethane-tetracarboxylic acid and derivs

6 E151–E152

- 1,2-dinitroethane-tetracarboxylic acid tetraethyl ester 6 E151–E152
- 1,2-dinitrosoethane-tetracarboxylic acid tetraethyl ester 6 E152
- ethane-tetracarboxylic acid dianhydride 6 E151
- ethane-tetracarboxylic acid tetraethyl ester 6 E151
- ethane-tetracarboxylic acid tetrazide 6 E152
- ethane-tetracarboxylic acid tetrahydrazide 6 E152

Ethane-tetraurethane and derivs 6 E152

Ethane-tricarboxylic acid and derivs 6 E152–E154

- ethane-tricarboxylic acid triazide 6 E152
- ethane-1,1,1-tris (hydroxymethyl) trinitrate (MtrT) 6 E152–E154

Ethanoic anhydride see Acetic anhydride 1 A29

Ethanol 1 A14

Ethanol and derivs 6 E154–E180

- ethanol, analytical procedures 6 E155–E177
- ethanol azido-, nitroso- and nitro derivs 6 E177
- ethanol azidonitrate 6 E177
- ethanol-2,2-dinitro 6 E179
- ethanol, 2-nitro 6 E177–E178
- ethanol-2-nitronitrate 6 E178–E179
- ethanol-2,2,2-trinitro 6 E179–E180
- ethanol-2,2,2-trinitro-1-nitrate 6 E180

Ethanalamine and derivs see Aminoethanol and derivs 1 A200–A201; 6 E180–E181

- Ethanolamine-diphenylcarbamide complexes
see Diphenylcarbamide complexes . . . smoke-
less proplnts 5 D1445–D1446
- Ethanolaminonitrate-methylurethane 6 E181
- Ethanolamino-tetrazido-copper 6 E181
- Ethanolaniline and derivs see Anilino-ethanol
and derivs 1 A424–A429; 6 E181
- Ethanolbenzene and derivs 6 E181–E182
ethanol-2,4-dinitrobenzene 6 E181
ethanol-2,4-dinitrobenzene nitrate 6 E182
ethanolnitrate-nitrobenzene 6 E182
ethanol-2,4,6-trinitrobenzene 6 E181–E182
ethanol-2,4,6-trinitrobenzene nitrate 6 E182
- Ethanol chloride see Chloroethanol 3 C254
- Ethanol-N-diphenylamine see Diphenylamino-
ethanol 5 D1441
- Ethanol diphenylurea 6 E182
- Ethanoylethylenediamine and derivs 6 E182–E183
N-ethanolgluconamide 6 E183
N-ethanolgluconamide hexanitrate 6 E183
1-nitroxy-3,6-diazahexane dinitrate
6 E182–E183
- Ethanolhydroxyacetamide and derivs 6 E183
N-ethanolhydroxyacetamide dinitrate 6 E183
- Ethanolmethylethylenediamine and derivs 6 E183
N-ethanolnitrate-N-methylethylenedinitramine
6 E183
- Ethanolnitramine see 1-Nitraminoethanol 1 A200
- Ethanolnitrate-nitrobenzene 6 E182
- Ethanol nitrilo and derivs 6 E183–E184
ethanol-2,2',2''-nitrilotrinitrate, dimer 6 E184
nitrilotrinitroethanol 6 E183
nitrilotrinitroethanol nitrate 6 E183–E184
nitrilotrinitroethanol phosphate 6 E184
- Ethanoloxime 1 A15–A16
- Ethanoloxypropanediol and derivs 6 E184
ethanol-2-oxypropane-2,3-diol dinitrate 6 E184
ethanol-2-oxypropane-2,3-diol trinitrate 6 E184
- Ethanol perchlorate 6 E184
- Ethanol tetranitroanilino nitrate see 2-(2',4',6'-
Trinitro-N-nitranilino)-ethanol nitrate
1 A425–A429
- Ethanol-2,4,6-trinitrobenzene 6 E181–E182
- EtCell see Ethylcellulose 6 E219–E222
- Ethenoxyethene see Divinylether 5 D1526
- Ethenylamidooxime and derivs 6 E184–E185
0-1-(1,1-dinitroethane) ethenylamidooxime
6 E185
N-dioxo-0-1-(1,1-dinitroethane) ethenylamido-
oxime 6 E185
N-dioxoethenylamidooxime 6 E185
N-hydroxyethenylamidooxime 6 E185
nitroethenylamidooxime 6 E185
N-oxoethenylamidooxime 6 E185
- Ethenyldiphenylamidine see N,N'-Diphenyl-
acetamidine 5 D414
- Ether a 56° (Fr) 6 E189
- Ether amylozotique (Fr) see Amyl nitrate 1 A397
- Ether, diethyl see Diethyl ether 5 D1233–D1235;
6 E185–E189
analytical procedures 6 E186–E189
uses of 6 E185–E186
- Ether etylique (Fr) see Diethyl ether 5 D1233
- Ether methylazotique 6 E189
- Ether-oxyline expls 6 E189
- Ethoxyacetamide 6 E189–E190
- Ethoxyacetanilide see Acetamidophenetole 1 A20
- Ethoxyacetazide 6 E190
- Ethoxyacetylene 6 E190
- Ethoxyaminobenzenes see Aminophenetols
1 A240
- 2-Ethoxy-2-nitramino-1-nitroimidazolidine 6 E190
- Ethoxyanilines see Aminophenetols 1 A240
- Ethoxybenzazide 6 E190
- Ethoxydiphenylamine and derivs 6 E190–E191
ethoxydiphenylamines, dinitro 6 E191
ethoxydiphenylamines, trinitro 6 E191
- Ethoxyethanol and derivs 6 E192
2-ethoxyethanol azide 6 E192
2-ethoxyethanol nitrate 6 E192
1-ethoxyethyl hydroperoxide 6 E192
3- (or 4-) β -ethoxyethyl- (4H-) 1,2,4-triazoles
6 E192

- 1-Ethoxy-2-[1'-hydroxy-1',4'-hydroxy-1',4'-dimethylpentene-4']-ethine **6 E192**
- 1-Ethoxymethyl-3,5-dinitro-1,3,5-triazacyclohexane **6 E192–E193**
- 3-(Ethoxymethyl)-hexahydro-1,5-dinitro-1,3,5(1H)-triazepine **6 E193**
- Ethoxynaphthalene and derivs **6 E193**
- 2-ethoxy-7,8-dinitroso-trinitronaphthalene **6 E193**
- 1-ethoxy-2,4,5-trinitronaphthalene **6 E193**
- Ethoxypentane and derivs **6 E193**
- 1,1,1-trinitro-2-ethoxypentane (TNEP) **6 E193**
- Ethoxyphenylaminotetrazole see Aminoethoxyphenyltetrazoles **1 A202**
- Ethoxyphenylarsinic acid and derivs **6 E194**
- 3,5-dinitro-4-ethoxyphenylarsinic acid **6 E194**
- Ethoxyphenyltetrazole and derivs **6 E194**
- p-ethoxyphenyltetrazoloazide **6 E194**
- Ethoxyphenylurethane and derivs **6 E194**
- 2,3,6-trinitro-4-ethoxyphenylurethane **6 E194**
- Ethoxyquinonediazole and derivs **6 E194**
- 4-ethoxy-3,6-dinitro-o-benzoquinonediazide (1) **6 E194**
- 3 (?) -ethoxy-5,6-dinitro-o-quinonediazide **6 E194**
- 5-Ethoxytetrazole **6 E194**
- Ethoxythiophene and derivs **6 E195**
- 3,5-dinitro-2-ethoxythiophene **6 E195**
- Ethoxytriazheptane and derivs **6 E195**
- 1-ethoxy-2,4,6-trinitro-2,4,6-triazheptane (MSX) **6 E195**
- Ethylacardite see Acardite III **1 A8**
- Ethylacetamide and derivs **6 E195**
- N-aminoethylacetamide and derivs **6 E202**
- N-(2,2-dinitroethyl) acetamide **6 E195**
- N-nitro-N-(2-dinitroethyl) acetamide **6 E195**
- N-(2,2,2-trinitroethyl) acetamide **6 E195**
- N-(2,2,2-trinitroethyl)-azidoacetamide **6 E195**
- n-Ethylacetanilide (mannol) and deriv **6 E195–E196**
- 4-nitro-N-ethylacetanilide (nitro-mannol) **6 E196**
- Ethylacetate and derivs **6 E196–E200**
- ethylacetate, azido- and nitrated derivs **6 E199–E200**
- ethyl acetate, technical **6 E196–E198**
- ethyl acetate, use in Fr proplnts and its determination in them **6 E199**
- Ethylacetic acid see Butyric acid **2 B391**
- Ethylacetoacetic acid and derivs **6 E200–E201**
- ethylacetoacetic acid diazide **6 E201**
- Ethylacetone **6 E201**
- Ethylacetoneitrolic acid and derivs **6 E201**
- 1,1-dinitroethyl-acetonitrolic acid **6 E201**
- Ethylacetylene and derivs **6 E201**
- 1-nitroethylacetylene **6 E201**
- Ethylacridine and derivs **6 E201**
- N-ethylacridone **6 E201**
- N-ethyl-2,4,5,7-tetranitroacridone **6 E201**
- α -Ethylacrolein oxime **1 A129**
- Ethylacrylate and derivs **6 E201–E202**
- ethyl-2-nitroacrylate **6 E202**
- 2-nitratoethylacrylate **6 E202**
- 2-nitroethylacrylate **6 E202**
- trinitroethylacrylate **6 E202**
- Ethyl alcohol see Ethanol **6 E154**
- Ethylaldehyde **1 A14–A15**
- Ethylamidine see α -Amino- α -imidoethane **1 A223**
- Ethylamine see Aminoethane **1 A199–A200**
- Ethylamine-azide **1 A199**
- Ethylaminoanisole and derivs **6 E202–E203**
- dinitroethylaminoanisoles **6 E202–E203**
- Ethyl p-aminobenzoate and derivs **6 E203**
- ethyl p-amino-dinitrobenzoates **6 E203**
- ethyl p-aminonitrobenzoates **6 E203**
- Ethylaminocellulose see Aminoethylcellulose **1 A203**
- Ethylaminocellulose nitrate and perchlorate **1 A204**
- Ethylamino compounds **1 A204–A209**
- Ethylaminoethanol and derivs **6 E203–E204**
- ethylaminoethanol nitrate **6 E203**
- 1-(N-ethyl)-nitramino-2-ethanol nitrate **6 E203–E204**

- Ethylaminoethylguanidine and derivs **6 E204**
 2-ethyl-1-(2-nitraminoethyl)-3-nitroguanidine **6 E204**
- Ethylaminoethyl-pseudourea and derivs **6 E204**
 2-ethyl-1-(2-nitraminoethyl)-3-nitropseudourea **6 E204**
- 3-(β -Ethylaminoethyl)- α -sym-triazole **1 A208–A209**
- Ethylaminoguanidine see Aminoethylguanidine **1 A205**
- Ethylaminoimidazoline and derivs **6 E204**
 1-(2,2,2-trinitroethyl)-2-nitramino-2,3-imidazolone **6 E204**
- Ethylaminonylon and its perchlorate see Aminoethylnylon **1 A205**
- Ethylaminophenols and derivs **6 E204–E205**
 dinitro-N-ethylaminophenols **6 E204**
 [N'-(4-ethylaminophenyl), N'-oxy-N³-methyl-N³-phenyl]-triazine **6 E205**
 trinitro-N-ethylaminophenols **6 E204–E205**
- Ethylaminopolyurethane see Aminoethylpolyurethane **1 A205**
- Ethylaminopolyvinyl alcohol and its chloride and perchlorate see Aminoethylpolyalcohol **1 A205**
- Ethylaminopropylureas see Aminoethylpropylureas **1 A206**
- 5-Ethylamino- α -tetrazole **1 A207**
- Ethylaminoprotein see Aminoethylprotein **1 A206**
- N-Ethylaminotetrazoles see Aminoethyltetrazoles and derivs **1 A206–A207**
 5-(trinitro-N-ethylamino)-tetrazole **6 E205**
- Ethylaminotriazoles see Aminoethyltriazoles **1 A207–A209**
- Ethylaminoureas see Aminoethylureas **1 A209**
- Ethylammonium tetranitratozincate **6 E205–E206**
- N-Ethylaniline and derivs **6 E206–E207**
 dinitro-N-ethylanilines **6 E206**
 N-ethylaniline-pentazidocuprate **6 E207**
 N-ethyl-N,2,3,4,6-pentanitroaniline **6 E207**
 N-ethyl-N,2,4,6-tetranitroaniline **6 E207**
 N-ethyl-2,4,6-trinitro-N-nitrosoaniline **6 E207**
 nitro-n-ethylanilines **6 E206**
- N-Ethylaniline and derivs (cont'd)
 N-nitro-N-ethyl-4-nitroaniline **6 E206**
 trinitro-N-ethylanilines **6 E206**
- Ethylazahexanoate and derivs **6 E207**
 trinitroethyl-2,5,5-trinitro-2-azahexanoate **6 E207**
- Ethylazaurolic acid **1 A517**
- Ethyl azelate and derivs **6 E207–E208**
 bis (trinitroethyl)-azelate **6 E208**
- Ethyl azide see Azidoethane **6 E142**
- Ethylazidobenzamide **6 E208**
- Ethyl- α -azido-ethylaceto-acetate **6 E208**
- Ethylazidoformate **6 E208**
- Ethylazidomalonic acid diamide **6 E208**
- Ethyl-5-azidopentanoate **6 E315**
- Ethylbenzamide and derivs **6 E208**
 N- $[\beta$ -azidoethyl]-benzamide **6 E208**
 3- (or 4-) nitroethylbenzamides **6 E208–E209**
- Ethylbenzene and derivs **6 E209–E214**
 α -azido- β -nitroethylbenzene **6 E209**
 3,5-bis (2,2,2-trinitroethyl)-1-nitrobenzene **6 E213**
 ethylbenzene azides **6 E209**
 ethyl-2,4-dinitrobenzene (DNEtB) **6 E210–E212**
 1-ethylmononitrobenzenes **6 E209**
 1-ethyl-2,4,6-trinitrobenzene (TNEtB) **6 E212–E213**
 4-nitro (2-nitroethyl)-benzene **6 E209–E210**
 1-nitro-4-(2,2,2-trinitroethyl)-benzene **6 E213**
 1,3,5-trinitro-4-(2,2,2-trinitroethyl)-benzene **6 E213**
 1,3,5-tris (2,2,2-trinitroethyl)-benzene **6 E214**
- Ethylbenzene sulfonamide and derivs **6 E214**
 N-trinitroethylbenzene sulfonamide **6 E214**
 N-trinitroethylnitrobenzene sulfonamides **6 E214**
- Ethylbenzoate and derivs **6 E214–E215**
 ethyl-o-benzoyl-benzoate **6 E215**
 ethylnitrobenzoates **6 E214**
 ethyl-s-nitro-o-benzoylbenzoate **6 E215**
 2,2,2-trinitroethylbenzoate **6 E215**
 2,2,2-trinitroethyl-3,5-dinitrobenzoate **6 E215**
 2,2,2-trinitroethyl-m-nitrobenzoate **6 E215**
 2,2,2-trinitroethyl-2,4,6-trinitrobenzoate **6 E215**

- N-Ethyl-N-benzoylnaphthylamine-1-diazonium hydroxide see 4-[(N-Benzoyl-N-ethyl-amino)-naphthalene-1-diazonium hydroxide 2 B90
- Ethylbenzylamine chlorate see Benzylethylamine chlorate 2 C187
- Ethyl-bis (aminoethyl)-carbamate and derivs 6 E216
ethyl-N, N-bis (β -nitraminoethyl)-carbamate 6 E216
- Ethyl-bis (triazomalonate) 6 E216
- Ethyl borate 2 B247
- Ethyl-t-butyl peroxide 6 E216
- Ethylbutyramide and derivs 6 E216
N-(2,2,2-trinitroethyl)-4,4,4-trinitrobutyramide 6 E216
- Ethylbutyrate and derivs 6 E216–E217
ethyl-4,4,4-trinitrobutyrate (EtTNBu) 6 E216
2,2,2-trinitroethyl-4,4,4-trinitrobutyrate (TNEtTNBu or TNETNB) 6 E217
trinitroethyl-trinitrobutyrate homologs 6 E217
- Ethylcarbamate or urethane and derivs 6 E217–E218
ethylcarbamate azide 6 E217–E218
trinitroethylcarbamate 6 E218
2,2,2-trinitroethylcarbamic acid, 2,2,2-trinitro-ethylester 6 E218
- Ethylcarbazole and derivs 6 E218–E219
9-ethylnitrocarbazoles 6 E218
9-ethyl-1,3,6,8-tetranitrocarbazole 6 E218
- Ethylcarbonate and derivs 6 E219
hexanitroethylcarbonate 6 E219
- Ethylcellulose (EtCell) 6 E219–E222
US military requirements (MIL-E-10853B, Dec 1958) 6 E220–E222
- Ethyl centralite see Centralite 1 or Carbamite 2 C127–C134
- Ethyl chloride see Chloroethane 3 C254; 6 E223
- Ethyl chlorite 6 E223
- Ethylchloroacetate 6 E223
- Ethylchlorocarbonate 6 E223
- Ethylchlorosulfonate 2 C169; 6 E223
- Ethylcresol and derivs 6 E223
5-ethyl-2,4,6-trinitro-m-cresol 6 E223
- Ethylcyanide 6 E223
- Ethylcyanoacetate 6 E223–E224
- Ethylcyanoformate see Chemical warfare agents 2 C169
- Ethylcyanomethylamine and derivs 6 E224
N-trinitroethyl-N-cyanomethyl nitramine 6 E224
- 1-Ethylcyclohexyl hydroperoxide-p-nitrobenzoate 6 E224
- Ethyldiaminomethane and derivs 6 E224
N-ethyl-N,N'-dinitroaminomethane 6 E224
- Ethyl diazaheptanoate and derivs 6 E224–E225
2,2,2-trinitroethyl-2,4,6,6-tetranitro-2,4-diazaheptane 6 E225
2,2,2-trinitroethyl-4,6,6-trinitro-2,4-diazaheptanoate 6 E225
- Ethyl diazoacetate 6 E225
- Ethyl diazosuccinate 6 E225
- Ethyl dichloramine see N,N-Dichloroethylamine 5 D1210
- Ethyl dichloroarsine see Chemical warfare agent ED 2 C167
- Ethyl dichlorosulfide 6 E225
- Ethyl diethanolamine and derivs 6 E225–E226
US military requirements and tests 6 E225–E226
- N-Ethyl-(dimethylphenyl)-amine 6 E226
N-ethyl-x,x-dimethyl-y,y-dinitroanilines 6 E227
N-ethyl-3,5-dimethyl-2,4,6-trinitroaniline 6 E227
N-ethyl-N-nitro-3,6-dimethyl-2,4-dinitroaniline 6 E227
N-ethyl-N-nitro-3,5-dimethyl-2,4,6-trinitroaniline 6 E227
- 2-Ethyl-1,3-dimethyl (propanediol) see 1,1-Di(methylol)-propane 5 D1358
- N-Ethyl-3,5-dimethyl-2,4,6-trinitroaniline 6 E227
- N-Ethyl-N,N'-dinitroaminomethane 6 E224
- Ethyl dinitrobenzoates 6 E214–E215

- 1-Ethyl-2,4-dinitrobenzene (DNEtB)
6 E210–E212
- Ethyl-3,3-dinitrolactate 6 E307
- Ethyl-(4,6-dinitro-3-methylphenyl) ether 6 E313
- Ethyl-4,4-dinitropentanoate 6 E316
- Ethyl dinitrophenols 6 E317
- Ethyl dinitrophenylamines 6 E319
- Ethyl-2,4-dinitrophenylglycinate 6 E321
- 1-Ethyl-1-(2,4-dinitrophenyl) hydrazine 6 E322
- N-Ethyl-N'-(2,4-dinitrophenyl) ureas
6 E322–E323
- Ethyl-2,2-dinitropropylamine nitrate 6 E326
- N-Ethyl-5 (or 6)-x-dinitro-2-quinolones
6 E328–E329
- 4(1)-Ethyl-3,5-dinitro-1,2,4-triazole 6 E336
- Ethyl diphenylamine and derivs 6 E227
N-ethyl-2,4-dinitrodiphenylamine 6 E227
N-ethyl-hexanitrodiphenylamine 6 E227
N-ethyl-1 (or 4) -nitrodiphenylamine 6 E227
N-ethyl-2,4,6-trinitrodiphenylamine 6 E227
- N'-Ethyl-N,N-diphenylurea see Acardite III
1 A8–A9
- Ethylene and derivs 6 E228–E230
ethyleneamine 6 E230
ethylene-carbon tetrachloride explns 6 E228
ethylene dichloride 6 E228
ethylene expl decomposition 6 E228–E229
ethylene reaction with NO₂ 6 E229
nitroethylene 6 E229
nitroethylene polymer (NEtPol) 6 E229–E230
nitrosoethylene 6 E230
- Ethyleneaminooxime and derivs 6 D230
nitroethyleneaminooxime 6 E230
- Ethylenebisacetamide and derivs 6 E230–E231
N,N'-dinitroethylene bisacetamide 6 E231
- N,N'-Ethylene-bis-(anthranilnitrile) and derivs
6 E342–E232
N,N'-ethylene-bis (dinitroanthranilnitriles)
6 E231
N,N'-ethylene-bis (nitroanthranilnitriles)
6 E231
N,N'-ethylene-dinitramine-bis-(nitroanthranilo-
nitriles) 6 E232
- 2,2'-Ethylene-bis (4,6-diamino-5-triazene) 6 E232
- Ethylene-bis (N,N-diphenylurea) 6 E232
- Ethylenebis (guanidine) and derivs 6 E232–E233
1,1'-ethylenebis-(3-nitroguanidine) 6 E232
- 2,2'-(Ethylenebisimino)-diethanol and derivs
6 E232–E233
2,2'-(ethylenebisimino)-diethanol dinitrate
6 E232
2,2'-(ethylenebisnitroimino)-diethanol 6 E233
2,2'-(ethylenebisnitroimino)-diethanol dinitrate
6 E233
- (Ethylenebisimino)-dimethanol and derivs see
N,N'-Di(methylolamino) ethane 5 D1351; 6 E233
(ethylenebisnitroimino)-dimethanol see
N,N'-Dimethylol-1,2-dinitroiminoethane
5 D1351
(ethylenebisnitroimino)-dimethanol dinitrate
see N,N'-Dimethylol-1,2-dinitroiminoethane
dinitrate 5 D1351
- (Ethylenebisimino)-imidazolidine and derivs
6 E233
1,1'-[ethylenebis (3-nitro-2-nitroimino)]-
imidazolidine 6 E233
- Ethylenebisurea and derivs 6 E233
[ethylenebis (3-nitrourea)] 6 E233
1,1'-(ethylenebisurea)-dinitrate 6 E233
- Ethylenebisurethane and derivs 6 E234
ethylenebisurethane-1-azide 6 E234
- Ethylenebromohydrine see 2-Bromoethanol
2 B311
- Ethylene-carbon tetrachloride explns 6 E228
- Ethylene chloride see Chloroethylene
3 C255–C256
- Ethylene cyanohydrin 6 E234
- Ethylenediamine and derivs 6 E235–E246
EDNAFIVE 6 E245
EDNA salts 6 E243–E244
EDNATOLS 6 E245–E246
ethylenediamine-chromium tetroxide 6 E235
ethylenediamine complexes 6 E235–E236
ethylenediamine dichlorate 2 C188
ethylenediamine dinitrate (EDD or EDAD)
6 E236–E237
ethylenediamine-dinitroform salt 6 E237

- Ethylenediamine and derivs (cont'd)
 ethylenediamine-N,N'-dinitroglucosidurethane dinitrate 6 E246
 ethylenediamine diperchlorate 6 E237-E238
 ethylenediamine dipicrate see 1,2-Bis-(2',4',6'-trinitroanilino)-ethane 2 B131
 ethylenediaminetetraacetic acid (EDTA) 6 E238
 ethylene dichloride 6 E228
 ethylenedinitramine (EDNA or Haleite) 6 E238-E243
 ethylene-N,N'-dinitramine dipicrate see 1,2-Bis-(2',4',6'-trinitronitranilino)-ethane 2 B131; Ditetryl 5 D1513
- Ethylenedibromide 6 E246
- Ethylenedichloride see 1,2-Dichloroethane 5 D1209; 6 E246
- Ethylenediglycolamide and derivs 6 E246-E247
 dinitro-N,N'-ethylenediglycolamide dinitrate 6 E246-E247
 N,N'-ethylenediglycolamide dinitrate 6 E246
 nitro-N,N'-ethylenediglycolamide dinitrate 6 E246
- Ethylene-N,N'-dinitramine dipicrate see 1,2-Bis-(2',4',6'-trinitronitranilino)-ethane 2 B131; Ditetryl 5 D1513
- Ethylenedinitramine (EDNA or Haleite) 6 E238-E243
- N,N'-Ethylenedinitramine-bis-(nitroanthranilone-nitriles) 6 E232
- Ethyl dinitrophenylcarbamates 6 E320
- 1,5-Ethylene-3,7-dinitro-1,3,5,7-tetraaza-2,4,6,8-cyclooctane see 3,7-Dinitro-1,5-endoethylene-1,3,5,7-tetraaza-2,4,6,8-cyclooctane 5 E90
- Ethylenedioxyamine 6 E247
 nitrate 6 E247
 perchlorate (EDAP) 6 E247
- Ethylenedioxybenzene see Benzodioxan 2 B66
- Ethylenediphenyldiamine see N,N'-Diphenylethylenediamine 5 D1457
- Ethyleneditetrazylazide 6 E247
- Ethylene expls decomposition 6 E228-E229
- Ethyleneglycol and derivs 6 E247-E256
 ethyleneglycol acetate 6 E253
 ethyleneglycol acetate dinitrate 6 E253
 ethyleneglycol: analysis and test methods 6 E250-E252
 ethyleneglycol butylether 6 E254
 ethyleneglycol butylether acetate 6 E254
 ethyleneglycol condensation products 6 E254
 ethyleneglycol diacetate 6 E254
 ethyleneglycoldiacrylate 6 E255
 ethyleneglycol diethylether (GDDE or diethyl cellosolve) 6 E255
 ethyleneglycol dilactate dinitrate 6 E255
 ethyleneglycol dimethylether (EGDME) 6 E255
 ethyleneglycol diphenylether 6 E255
 ethyleneglycol-di-trinitrobutyrate (EGTNB or GTNB) 6 E255-E256
 ethyleneglycol ethylether 6 E256
 ethyleneglycol ethylether acetate 6 E256
 ethyleneglycolformal see 1,3-Dioxalane 5 D1405-D1406
 ethyleneglycolglycolate dinitrate 6 E256
 ethyleneglycol-sugar mixture, nitrated 6 E253
 ethyleneglycol polymers 6 E252-E253
- Ethyleneglycolglucoside and derivs 6 E256
 ethyleneglycol-glucoside nitrate (EGGN) 6 E256
- Ethyleneglycol lactate 6 E257
 dinitrate 6 E257
- Ethyleneglycol methylether 6 E257
- Ethyleneglycol methylether acetate 6 E257
- Ethyleneglycol monoalkyl ethers 6 E257-E258
- Ethyleneglycol nitrites and nitrates 6 E258-E279
 ethyleneglycol dinitrate (EGDN, EGcDN or NGc) 6 E259-E279
 ethyleneglycol dinitrite 6 E259
 ethyleneglycol nitrate 6 E258-E259
 ethyleneglycol phenylether and derivs 6 E279
 ethyleneglycol polymers nitrated 6 E279-E280
 ethylene nitrite-nitrate 6 E258
- Ethyleneguanidine and derivs 6 E280-E281
 nitraminoimidazole 6 E281
 2-nitraminoimidazoline-2 6 E280
 2-nitriminoethyleneguanidine 6 E280
 1-nitro-2-aminoimidazoline-2 6 E281
 1-nitroethyleneguanidine 6 E280-E281
 1-nitro-2-nitraminoimidazoline-2 6 E281

- Ethyleneguanidine and derivs (cont'd)
 1-nitro-2-nitriminoethyleneguanidine **6 E281**
 N-nitrosoethyleneimine **6 E282**
 1-nitroso-2-nitraminoimidazoline-2 **6 E281**
 1-nitroso-2-nitriminoethyleneguanidine **6 E281**
- Ethyleneimine and derivs **6 E281–E282**
- Ethylene-iso-thiourea and derivs **6 E291**
 nitroethylene-iso-thiourea **6 E291**
- Ethylene nitro **6 E282**
- Ethyleneoxamide and dinitroethyleneoxamide
5 D1299–D1300; 6 E282
- Ethylene oxide (EtnO) **6 E282–E290**
 ethylene oxide, proplnt, US military specification (MIL-P-8845A, 30 June 1969)
6 E288–E290
 ethylene oxide, technical, US military specification (MIL-E-52172) **6 E285–E288**
 ethylene oxide, toxicity **6 E283–E284**
 ethylene oxide, uses **6 E284**
- Ethylene ozonide **6 E290**
- Ethylene pseudonitrosite **6 E290–E291**
- Ethylene reaction with NO₂ **6 E229**
- Ethylene tetrafluoride **6 E291**
- Ethylenetetranitramine **6 E291**
- Ethyleneurea and derivs **6 E291–E292**
 N,N'-dinitroethyleneurea (DNEU) **6 E292**
- Ethylester of carbamic acid or urethane see
 Carbamic acid ethylester **2 C40–C41**
- Ethylester of dimethylaminocyanophosphoric
 acid see GA chemical warfare agent
2 C167; 6 E292
- Ethylester of trinitrocarbamlic acid **2 C43**
- Ethylester of (trinitro deriv) of N,N'-dinitro-
 methylenedicarbamic acid **6 E292–E293**
- N-Ethylester (trinitro deriv) of ethane sulfonamide
6 E293
- [Ethylester (trinitro deriv)] of fumaric acid, bis
6 E293
- Ethylester (trinitro deriv) of methylenedi-
 carbamic acid **6 E293**
- Ethylester (trinitro deriv) of 2,5,5,8-tetranitro-
 2,8-diazanonanedioic acid **6 E293**
- Ethylester (trinitro) deriv of ethylsuccinic acid,
 bis-trinitro **6 E293–E294**
- Ethylethanolperoxide **6 E294**
- Ethylether see Diethylether **5 D1233**
- Ethyl ether (analytical) **6 E294**
- Ethylethoxyphenylurea and derivs **6 E294**
 nitroethyl-trinitroethoxyphenylurea **6 E294**
- Ethylethylene see Butene **2 B375**
- Ethylethyl hydrazine see Diethylhydrazine
5 D1237
- Ethylfluoroformate **6 F133**
- Ethylformal polysulfide **6 E294**
- Ethylformate **6 E294**
- Ethylfuroate **6 E295**
- Ethyl- β -furylacrylate **6 E295**
- Ethylglucopyranoside and derivs **6 E295**
 ethylglucopyranoside tetranitrate **6 E295**
- Ethylglycerate **6 E295**
- Ethylglycinate and derivs **6 E295–E296**
 ethylglycinate hydrochloride **6 E296**
 N-nitro-ethylglycinate **6 E295**
- Ethylglycine ethylester and derivs **6 E296**
 N-2,2-dinitroethylglycine ethylester **6 E296**
 N-2,2-dinitroethyl-N-nitroglycine ethylester
6 E296
- Ethylglycolate and derivs **6 E296**
 ethylglycolate nitrate **6 E296**
 trinitroethylglycolate nitrate **6 E296**
- Ethylglycol ether and derivs **6 E296–E297**
 ethylglycol ether nitrate **6 E296–E297**
 mononitroethylglycol ether **6 E297**
- Ethylglycolic acid **6 E297**
- Ethylguanidine and derivs **6 E297–E298**
 1,1-dinitro-2-guanidinoethane **6 E298**
 1,3-dinitro-3-(2,2,2-trinitroethyl)-guanidine
6 E298
 1-ethyl-3-nitroguanidine **6 E297**
 1-ethyl-3-nitrosoguanidine **6 E297**

- Ethylguanidine and derivs (cont'd)
 1-ethyl-1-nitroso-3-nitroguanidine 6 E297
 1-nitro-3-(2,2,2-trinitroethyl)-guanidine
 6 E298
- Ethylhexahydro pyrimidine and derivs 6 E298
 5-ethylhexahydro-5-nitro-1,3-dinitroso
 pyrimidine 6 E298
 5-ethylhexahydro-5-nitropyrimidine 6 E298
- Ethylhexahydro-triazine and derivs 6 E298
 3,5-dinitro-1-ethyl-2,4,6-hexahydro-1,3,5-
 triazine 6 E298
- 2-Ethyl-1,3-hexanediol 6 E298–E299
- N-ethyl-hexanitrodiphenylamine 6 E227
- Ethylhexoic acid and derivs 6 E299
 2-ethylhexyl acetate 6 E299
 2-ethylhexyl acrylate 6 E299
 lead 2-ethylhexoate 6 E299
- 2-Ethylhexyl alcohol 6 E300
- Ethylhydracrylate and derivs 6 E300
 ethylnitratohydracrylate 6 E300
 ethyl-2-nitrohydracrylate 6 E300
- Ethyl hydrazine and derivs 6 E300
 2,2-dinitroethyl hydrazine 6 E300
- Ethylhydroperoxide and derivs 6 E300–E301
 ethylhydroperoxide salts 6 E300–E301
- Ethyl hydroxyacetamide 6 E301
- 2-Ethylhydroxy-iso-butyrate 6 E301
- Ethyl-1-hydroxyethyl peroxide 6 E301
- Ethylhydroxymethyl peroxide 6 E301
- Ethylhydroxymethyl-propanediol and derivs
 6 E301–E302
 2-ethyl-2 (hydroxymethyl)-1,3-propanediol
 dinitrate 6 E301
 2-ethyl-2 (hydroxymethyl)-1,3-propanediol
 trinitrate 6 E301–E302
- Ethylhypochlorite 6 E302
- Ethylhyponitrite see Diethylhyponitrite 5 D1238
- Ethylidene acetobenzoate and derivs 6 E302
 ethylidene aceto-3,5-dinitrobenzoate 6 E302
- Ethylidene acetone 6 E302
- Ethylideneaminoguanidine and derivs 6 E302
 ethylideneaminoguanidine nitrate 6 E302
 1-ethylideneamino-3-nitroguanidine 6 E302
- Ethylidene aniline and derivs 6 E303
 ethylidene-2,4-dinitroaniline 6 E303
 β -nitroethylidene aniline 6 E303
 β -nitroethylidene-4-nitroaniline 6 E303
- Ethylidene chloride see Dichloroethane 5 D1209
- Ethylidene diacetamide 6 E303
- Ethylidene diacetate 6 E303
- Ethylidene dichloride see Dichloroethylidene
 5 D1209
- Ethylidene diethyl ether 1 A13
- Ethylidene difluoride 6 E304
- Ethylidene dimethylether 6 E304
- Ethylidene-2,4-dinitroaniline 6 E303
- Ethylidene diperoxide see Diethylidene
 diperoxide 5 D1238
- Ethylidene diurethane 6 E304
- 4,6-Ethylidene-methylglucosides and derivs
 6 E304–E305
 4,6-ethylidene- α -2,3-methylglucoside
 dinitrates 6 E305
 4,6-ethylidene- α (or β)-2 (or 3)-methyl-
 glucoside nitrates 6 E304–E305
- Ethylidene oxide 1 A14
- Ethylideneperoxide 6 E305–E306
- Ethylidene peroxide, dimeric 6 E306
- Ethylideneperoxide, polymeric 6 E306
- Ethylidene-[2,4,6-trinitrophenylhydrazine]
 1 A15
- Ethylidoacetate see Chemical agents (SK)
 2 C169
- 1-ethyl-iso-melamine 6 E307
- Ethyl-iso-propylaniline and derivs 6 E327
 N-ethyl-(2-nitro-iso-propyl) aniline,
 hydrochloride 6 E327
 2,4,6-trinitro-N-ethyl-iso-propylaniline 6 E327
- Ethyl lactate and derivs 6 E306–E307
 ethyl-3,3-dinitrolactate 6 E307

- Ethyl lactate and derivs (cont'd)
 ethyl lactate nitrate 6 E306–E307
 ethyl-2 (or 3)-nitrolactate nitrates 6 E307
- Ethyl malonate 6 E307
- Ethylmalonic acid and derivs 6 E307
 ethylmalonic acid monoazide 6 E307
- Ethylmercaptan 6 E307–E308
- Ethyl methacrylate 6 E308
- Ethylmethane sulfonamide and derivs 6 E308
 N-nitrotrinitroethylmethanesulfonamide
 6 E308–E309
 trinitroethylmethanesulfonamide 6 E308
- Ethylmethylaniline and derivs 6 E309
 2,4-dinitro-N-ethyl-N-methyl aniline 6 E309
 2 (or 4)-nitro-N-ethyl-N-methyl anilines
 6 E309
 N-(2-nitroethyl)-N-methyl aniline 6 E309
- Ethylmethylbenzenes and derivs 6 E309–E310
 dinitroethylmethylbenzenes 6 E310
 nitroethylmethylbenzenes 6 E309–E310
 trinitroethylmethylbenzenes 6 E310
- Ethylmethylbiimidazole and derivs 6 E311
 4-ethyl-4'-methyl-1,1',5,5'-tetranitro-2,2'-
 biimidiazole 6 E311
- Ethylmethyl carbinol see Butan-1-ol 2 B372
- N-Ethyl-methylenediamine see Diaminopropane
 5 D1142
- Ethylmethyl ether 6 E311
- Ethylmethylether and derivs 6 E311
 ethyl- α -methyl-trinitro-ethyl ether 6 E311
 ethyl- α -nitromethyl-ethyl ether 6 E311
 2-nitroethyl isopropyl ether 6 E311
- Ethylmethylisoxazole and derivs 6 E311
- Ethylmethyl ketone see Butanone 2 B374
- Ethylmethyl ketone peroxide 6 E312
- Ethylmethylketone-semicarbazone and derivs
 6 E312
 ethylmethylketone-semicarbazone azides
 6 E312
- Ethylmethyl nitrone and derivs see 3-Aza-4-
 oxa-hexene-2 1 A517; 6 E312
- Ethylmethyl peroxide 6 E312
- Ethylmethylphenyl ether and derivs 6 E312–E313
 ethyl-(4,6-dinitro-3-methylphenyl)-ether
 6 E313
 ethyl-(nitro-methylphenyl)-ethers 6 E312
 ethyl-(2,4,6-trinitro-3-methylphenyl)-ether
 6 E313
- 5-Ethyl-2-methyl pyridine (MEP) 6 E313
- 7-Ethyl-2-methyl-4-undecanol 6 E313
- 1-Ethyl-mononitrobenzenes 6 E209
- Ethyl mono-nitrophenols 6 E317
- Ethylnitramine see Nitraminoethane 1 A199
- 1-(N-Ethyl)-nitramino-2-ethanol nitrate
 6 E203–E204
- 2-Ethyl-1-(2-nitraminoethyl)-3-nitropseudourea
 6 E204
- Ethyl nitratohydracrylate 6 E300
- Ethylnitrobenzoates 6 E214
- Ethyl- α -nitro-o-benzoylbenzoate 6 E215
- 9-Ethylnitrocarbazoles 6 E218
- N-Ethyl-N-nitro-3,6-dimethyl-2,4-dinitroaniline
 6 E227
- N-Ethyl-N-nitro-3,5-dimethyl-2,4,6-trinitroaniline
 6 E227
- Ethyl-N-nitro-3,5-dinitrophenylcarbamate 6 E320
- Ethyl-N-nitro-N'-(dinitrophenyl) ureas
 6 E322–E323
- N-Ethyl-1 (or 4)-nitrodiphenylamine 6 E227
- 1-Ethyl-3-nitroguanidine 6 E297
- Ethyl-2-nitrohydracrylate 6 E300
- Ethyl-2 (or 3)-nitrolactate nitrates 6 E307
- Ethylnitrolic acid 6 E313
- N-ethyl-(2-nitro-iso-propyl)-aniline, hydrochloride
 6 E327
- Ethyl- α -nitromethylethyl ether 6 E311
- Ethyl-(nitro-methyl-phenyl)-ethers 6 E312
- Ethylnitropentanoates 6 E315–E316
- Ethylnitrophenylamines 6 E318–E319
- Ethyl-2-nitrophenylcarbamates 6 E320

- Ethylnitrophenylglycinates **6 E321**
 1-Ethyl-1-(4-nitrophenyl) hydrazine **6 E322**
 2-Ethyl-2-nitro-1,3-propanediol dinitrate see
 1,1-Di(methylol)-1-nitropropane dinitrate
5 D1359
 N-Ethyl-(2-nitropropyl)-aniline **6 E327**
 x-Ethyl-y-nitropyridines **6 E327–E328**
 N-Ethyl nitro quinolones **6 E328**
 N-Ethyl-6-nitro-2-quinolonium nitrate **6 E328**
 Ethylnitrosalic acid **6 E313–E314**
 1-Ethyl-3-nitrosoguanidine **6 E297**
 1-Ethyl-1-nitroso-3-nitroguanidine **6 E297**
 N-Ethyl-N-nitroso-2,4,6-trinitroaniline **6 E319**
 4-Ethyl-3-nitro-1,2,4-triazole **6 E335**
 N-Ethyl-N-nitro-N'-(2,4,6-trinitrophenyl) urea
6 E323
 Ethylolamine, dinitro see Aminoethanol **1 A201**
 Ethyloleate **6 E314**
 Ethyl oxalate **6 E314**
 Ethyl oxamate **6 E314**
 Ethyloxamide and derivs **6 E314**
 dinitroethyloxamide **6 E314**
 Ethyl palmitate **6 E314**
 Ethylpentane and derivs **6 E315**
 2,2-dinitro-3-ethylpentane **6 E315**
 3-nitro-3-ethylpentane **6 E315**
 2,2,3-trinitro-3-ethylpentane **6 E315**
 N-Ethyl-N,2,3,4,6-pentanitroaniline **6 E207**
 Ethylpentanoate and derivs **6 E315–E316**
 ethyl-5-azidopentanoate **6 E315**
 ethyl-4,4-dinitropentanoate **6 E316**
 ethylnitropentanoates **6 E315–E316**
 2,2,2-trinitroethyl-4,4-dinitropentanoate
 (TNEDNP) **6 E316**
 Ethyl perchlorate **6 E316**
 Ethyl peroxide see Diethyl peroxide **5 D1246**
 Ethyl peroxyacetate **6 E316**
 Ethylphenols and derivs **6 E316–E317**
 ethyldinitrophenols **6 E317**
 ethylmononitrophenols **6 E317**
 m-ethyl-2,4,6-trinitrophenol **6 E317**
 Ethylphenylacetic acid and derivs **6 E317–E318**
 2,4-dinitroethylphenylacetate **6 E318**
 ethylphenyl azidoacetic acid **6 E317–E318**
 ethylphenyl nitroacetate **6 E318**
 nitro ethylphenylacetic acids **6 E318**
 Ethylphenyl acetylene **6 E318**
 Ethylphenylamines and derivs **6 E318–E319**
 ethyldinitrophenylamines **6 E319**
 ethylnitrophenylamines **6 E318–E319**
 N-ethyl-N-nitroso-2,4,6-trinitroaniline **6 E319**
 N-ethyl-N,2,3,4,6-pentanitroaniline **6 E207**
 N-ethyl-N,2,4,6-tetranitroaniline **6 E207**,
E319–E320
 N-(2-nitrosoethyl-N,2,4,6-tetranitroaniline
1 A425
 Ethylphenylcarbamate and derivs **6 E320–E321**
 ethyldinitrophenylcarbamate **6 E320–E321**
 ethyl-N-nitro-3,5-dinitrophenylcarbamate
6 E320
 ethyl-2-nitrophenylcarbamates **6 E320**
 ethylphenylcarbamate, ethylester
6 E320–E321
 ethyl-2,4,6-trinitrophenylcarbamates **6 E320**
 Ethylphenylglycinate and derivs **6 E321**
 ethyl-2,4-dinitrophenylglycinate **6 E321**
 ethylnitrophenylglycinates **6 E321**
 ethylphenylglycineazido-o-carboxylate **6 E321**
 ethyl-2,4,6-trinitrophenylglycinate **6 E321**
 Ethylphenylhydrazine and derivs **6 E321–E322**
 1-ethyl-1-(2,4-dinitrophenyl) hydrazine **6 E322**
 1-ethyl-1-(4-nitrophenyl) hydrazine **6 E322**
 ethyl-2,4,6-trinitrophenyl hydrazine **6 E322**
 1-(2,2,2-trinitroethyl)-2-(2,4-dinitrophenyl)-
 hydrazine **6 E322**
 1-(2,2,2-trinitroethyl)-2-(2,4,6-trinitrophenyl)-
 hydrazine **6 E322**
 Ethylphenyl ketone **6 E322**
 Ethylphenylureas and derivs **6 E322–E323**
 N-(2-azidoethyl)-N'-phenylurea **6 E322**
 N-ethyl-N'-(dinitrophenyl) ureas **6 E322–E323**
 N-ethyl-N-nitro-N'-(dinitrophenyl) ureas
6 E323

- Ethylphenylureas and derivs (cont'd)
 N-ethyl-N-nitro-N'-(2,4,6-trinitrophenyl)-urea
 6 E323
 N-(2,2,2-trinitroethyl)-N'-nitro-N'-(3,4-dinitrophenyl)-urea 6 E323
 N-(2,2,2-trinitroethyl)-N'-phenylurea 6 E323
- Ethylphosphate and derivs 6 E322–E324
 tris-(2-nitroethyl)-phosphate 6 E323
 tris-(trinitroethyl)-phosphate 6 E324
- Ethylphosphorodimethylamidicyanadate see
 GA chemical warfare agent 2 C167; 6 E324
- Ethylphthalate (palatinol A) see o-Diethylphthalate 5 D1248; 6 E324–E325
 bis-(nitroethyl)-phthalate 6 E324
 bis (trinitroethyl)-phthalate 6 E324–E325
 dinitro ethylphthalates 6 E324
 nitro ethylphthalates 6 E324
- Ethylpropanediol and derivs 6 E325–E326
 2-nitro-2-ethyl-2,4-propanediol (NEP) 6 E325
 2-nitro-2-ethyl-1,3-propanediol dinitrate
 6 E325–E326
- Ethylpropionate 6 E326
- 2-Ethyl-3-propyl-acrolein 6 E326
- Ethylpropylamine and derivs 6 E326
 ethyl-2,2-dinitropropylamine nitrate 6 E326
 N-nitro ethyl-2,2-dinitropropylamine 6 E326
 N-nitro ethylpropylamine 6 E326
 2,2,2-trinitroethyl-3,3,3-trinitropropylamine
 6 E326
 N-(2,2,2-trinitroethyl)-N-(3,3,3-trinitropropyl)-
 nitramine 6 E326
- Ethyl-N-propylaniline and derivs 6 E327
 X,X-dinitro-N-ethyl-propylanilines 6 E327
 N-ethyl-(2-nitropropyl)-aniline hydrochloride
 6 E327
- Ethylpyridines and derivs 6 E327–E328
 2-(2-azidoethyl)-pyridine 6 E327
 4-(1,1-dinitroethyl)-pyridine 6 E328
 x-ethyl-y-nitropyridines 6 E327–E328
 2-(2-nitroethyl)-pyridine 6 E327
- Ethylquinolone and derivs 6 E328–E329
 N-ethyl-5 (or 6)-X-dinitro-2-quinolones
 6 E328–E329
 N-ethyl nitro quinolones 6 E328
 N-ethyl-6-nitro-2-quinolonium nitrate 6 E328
 N-ethyl-5 (-6 or -7)-trinitro-2-quinolone 6 E329
- Ethylsalicylate and derivs 6 E329–E330
 4-azidoethylsalicylate 6 E329
 3,5-dinitroethylsalicylate 6 E329
 3-(4- or 5-) nitroethylsalicylate 6 E329
 trinitroethyl-3,5-dinitrosalicylate 6 E330
 trinitroethyl salicylate 6 E329
- Ethyl silicate 6 E330
- Ethyl stearate and derivs 6 E330
 trinitroethyl stearate 6 E330
- Ethyl-substituted acid amides, N-trinitro derivs
 6 E330
- Ethylsuccinic acid and derivs 6 E330
 ethylsuccinyl diazide 6 E330
 ethyl succinyl hydrazide 6 E330
- Ethylsulfuric acid 6 E330
- N-Ethyl-N,2,4,6-tetranitroaniline
 6 E207; E319–E320
- 9-Ethyl-1,3,6,8-tetranitrocarbazole 6 E218
- Ethyltetrazinedicarboxylic acid and derivs 6 E331
 ethyltetrazinedicarboxylic azide 6 E331
- Ethyltetrazole and derivs 6 E331
 ethyltetrazylazide 6 E331
- Ethyltetrazolylcarbamate 6 E331
- Ethyltoluenes and derivs 6 E331–E332
 dinitroethyltoluenes 6 E333
 nitroethyltoluenes 6 E332
 4-(1-nitromethyl) toluene 6 E332
 trinitroethyltoluenes 6 E333
- Ethyltoluene sulfonate and derivs 6 E333
 3,5-dinitro-ethyl-p-toluene sulfonate
 6 E333–E334
 nitro-ethyl-p-toluene sulfonate 6 E333
 2,2,2-trinitroethyl-p-toluene sulfonate 6 E334
- N-ethyl-p-toluenesulfonamide and derivs 6 E334
 N-(2-azidoethyl)-p-toluene sulfonamide 6 E334
 3,N-dinitro-N-ethyl-p-toluene sulfonamide
 6 E334
 3-nitro-N-ethyl-p-toluene sulfonamide 6 E334
 N-nitro-N-ethyl-p-toluene sulfonamide 6 E334
 N-trinitroethyl-p-toluene sulfonamide 6 E334
- Ethyltoluidines and derivs 6 E334–E335
 dinitro (ethylamino) toluenes 6 E335
 nitroethylaminotoluene 6 E334–E335
 tetranitroethyltoluidine 6 E335

- Ethyltoluidines and derivs (cont'd)
trinitro (ethylamino) toluenes **6 E335**
- Ethyltriazole and derivs **6 E335–E336**
4(1)-ethyl-3,5-dinitro-1,2,4-triazole **6 E336**
4-ethyl-3-nitro-1,2,4-triazole **6 E335**
4-(2-nitroethyl)-3,5-dinitro-1,2,4-triazole
6 E336
- 3-Ethyl-1,2,4-triazole-5-diazoniumhydroxide
1 A208
- Ethyltrichlorosilane **6 E336**
- Ethyl-trimethyleneglycol and derivs **6 E336**
 β -nitro- β -ethyltrimethyleneglycol **6 E336**
- Ethyl-trimethylolmethane and derivs
6 E336–E337
azido ethyltrimethylolmethane **6 E336**
ethyltrimethylolmethane dinitrate
6 E336–E337
ethyltrimethylolmethane nitrate **6 E336**
ethyltrimethylolmethane trinitrate **6 E337**
- 1-Ethyl-2,4,6-trinitrobenzene (TNEtB)
6 E212–E213
- Ethyl-4,4,4-trinitrobutyrate (EtTNBu) **6 E216**
- 5-Ethyl-2,4,6-trinitro-m-cresol **6 E223**
- N-Ethyl-2,4,6-trinitrodiphenylamine **6 E227**
- Ethyl-(2,4,6-trinitro-3-methylphenyl)-ether
6 E313
- N-Ethyl-2,4,6-trinitro-N-nitrosoaniline **6 E207**
- m-Ethyl-2,4,6-trinitrophenol **6 E317**
- Ethyltrinitrophenylcarbamates **6 E320**
- Ethyl-2,4,6-trinitrophenylglycinate **6 E321**
- Ethyl-2,4,6-trinitrophenylhydrazine **6 E322**
- N-Ethyl-5 (-6 or -7)-trinitro-2-quinolone **6 E329**
- Ethylurea and derivs **6 E337**
azidoethylurea **6 E337**
N-nitro-N'-ethylurea **6 E337**
N-trinitroethylurea **6 E337**
- Ethylurethane and derivs **6 E337–E338**
dinitroethylurethane **6 E337**
N-nitro-ethylurethane **6 E337**
N-nitrotrinitroethylurethane **6 E337–E338**
trinitroethylurethane **6 E337**
- Ethylurethane de la furfurine (Fr) see
N-Carboethoxyfurfurine **2 C52**
- Ethylurethane de la morpholine (Fr) see
N-Carboethoxymorpholine **2 C53**
- Ethylvalerate and derivs **6 E338–E339**
azido ethyl valerates **6 E338**
4,4-dinitro ethyl valerate **6 E339**
4,4-dinitro-(2,2,2-trinitroethyl)-n-valerate
6 E339
nitro-ethyl-n-valerates **6 E338–E339**
4,4,4-trinitro-ethyl-iso-valerate **6 E339**
- Ethylvinyl carbinol **6 E339**
- Ethylvinyl ether **6 E339**
- Ethylvinyl hexoate **6 E339**
- Ethylvinylhexyl ether **6 E339–E340**
- Ethylvinylpyridine **6 E340**
- Ethylxylenes and derivs **6 E340**
5- (or 6-) nitro-4-ethyl-m-xylene **6 E340**
trinitro ethyl-o,m, or p-xylenes **6 E230–E341**
- Ethylxylidines and derivs **6 E341**
dinitro-(N-ethyl)-o or p-xylidines **6 E341**
5-nitro-4(N-ethyl)-o-xylidine **6 E341**
N,2,4,6-tetranitro-5-(N-ethyl)-m-xylidine
6 E341
trinitro-(N-ethyl)-m or p-xylidine **6 E341**
- Ethylxyloside and derivs **6 E341**
ethylxyloside trinitrate **6 E341**
- Ethyne see Acetylene **1 A58–A64**
- Ethynylation **6 E342**
- Etincelle d'allumage (Fr) **6 E342**
- Etirage des poudres (Fr) **6 E342**
- Etna or Hecla expl of Atlas Powder Co **6 E342**
- Etna powder **6 E342**
- Et-NENA see 1-(Ethyl)-nitramino-2-ethanol
nitrate **6 E203**
- Etnite **6 E342**
- EtnO see Ethylene oxide **6 E282–E290**
- Etoupille (Fr) **6 E342**
- Etoupille a friction (Fr) **6 E341**
- Etoupille a percussion **6 E342**

- Euler, Leonhard 6 E342
- Eulite 6 E342–E343
- “Eumuco” shell forging press 6 E343
- Eutectic (expl mixtures) 6 E343–E346
 , table of binary 6 E344–E345
 , table of ternary 6 E346
- Euxenite 6 E346
- Evaluating expls and hazardous materials, methods of US Bureau of Mines 6 E346
- Evaluation of toxic afterdetonation gases formed by industrial explosives 6 E346
- Evangelidi expl 6 E346
- “Evanohm” 6 E346
- Evaporation see Distillation 5 D1509–D1511,
 Drying D1560–D1565
- “Everdur” 6 E346
- Everling & Kandler 6 E346
- Eversoft plastex (Br) 6 E346
- Eversoft seamex 6 E346
- Eversoft tees powder 6 E347
- EW 6 E347
- EWPh 6 E347
- EWP thickened fuels 6 E347
- Extractor 6 E347
- Exaltation 6 E347
- Excavation by means of expls 6 E347
- Excelsior mill 6 E348
- Excentric pressed proplnt grains 6 E348
- Exchange coefficient see Coefficient d’échange (Fr) 3 C389
- Exchange reaction 6 E348
- Excitation or activation 6 E348
- Excitation 6 E348
- Excrement (carbonized expls) 6 E348
- Execution of safety 6 E349
- EXE powder 6 E348
- Exercise head, guided missile 6 E349
- Exercise head, torpedo 6 E349
- Exerciser 6 E349
- Exo 6 E349
- Exograph 6 E349
- Exos 6 E349
- Exothermic reaction 6 E349
- Exothermic reaction mixtures for underwater propulsion and ignition devices 6 E349
- Exotic fuels 6 E350
- Exotic proplnts 6 E350
- Expanding jet theory of Jones see Detonation and expansion nozzle theory of Jones 4 D460–D461
- Expansion 6 E350
- Expansion equations 6 E350
- Expansion, lateral see Detonation . . . lateral expansion . . . and lateral loss in 4 D421–D423
- Expansion ratio 6 E350
- Expansion, thermal coefficient of 6 E350–E351
- Expansion wave 6 E351
- Expansive or expanding bullets 6 E351
- Expedite 6 E351
- Expelling or ejecting charge see Charge 2 C150
- Expendable 6 E351
- Experimental determination of detonation velocity 4 D632–D640
- Experimental procedures in detonation . . . see Detonation . . . experimental procedures 4 D299–D346
- Experimental procedures for determination of properties of detonation waves see Refs 3, 32, 35, 44, 57, 67, 68, 69, 75, 94, 95a & 96 4 D724–D730
- Experimental type (of item developed for military service; definition of procedures and item types use; definition of procedures and item types) 6 E352
 engineering test 6 E352
 user test 6 E352

- Explode(s) **6 E353**
 Exploder **6 E353**
 Exploder (Brit) **6 E353**
 Exploder, magnetic **6 E353**
 Exploding ammo and expls destined for destruction **6 E357–E358**
 Exploding bridgewire (EBW) **6 E353–E354**
 Exploding bridgewire detonators of Reynolds Industries, Inc **6 E354**
 Exploding bridgewire devices; their protection from damage by spurious RF energy **6 E354–E355**
 Exploding bridgewire devices, nondestructive testing of **6 E355**
 Exploding bridgewire initiation of expls **6 E355–E356**
 Exploding conductors **6 E356**
 Exploding view **6 E353**
 Exploding wire materials **6 E356–E357**
 Exploration for natural gas and oil by seismic method **6 E358–E359**
 Explorer series of artificial earth satellites **6 E359**
 Exploseur électrique (Fr) **6 E359**
 Explosibility and flammability of expls, proplnts and pyrot compns **6 E359–E360**
 Explosif(s) (Belg and Fr) **6 E360**
 Explosifs a l'aluminum (Fr) see Aluminum containing expls **1 A146; 6 E360**
 Explosif amylyace see Amide (explosif) **1 A168**
 Explosif antigrisou see Antigrisou (explosif) **1 A466**
 Explosif "D" **6 E361**
 Explosif E **6 E361**
 Explosif "formule 63-CSE-1949" **6 E361**
 Explosif formule 226 **1 A146**
 Explosif le Marechal **6 E361**
 Explosif de mine (Fr) **6 E361**
 Explosif MDN (or MDn) **6 E361**
 Explosif MDPC **6 E361**
 Explosif MMN **6 E361**
 Explosif MMTC **6 E361**
 Explosif Muller **6 E361**
 Explosif NDNT **6 E362**
 Explosif Nor du type N **6 E361–E362**
 Explosif on °B minelite B **6 E363**
 Explosif P **6 E363**
 Explosif S **6 E364**
 Explosifs antigrisouteux **6 E360**
 Explosifs brisants (Fr) **6 E360**
 Explosif Sc (Fr) **6 E364**
 Explosifs C see C (explosifs) **2 C1**
 Explosifs chlorates see Chlorate Cheddites **2 C155–C159**
 Explosifs couche **6 E360**
 Explosifs CSE see CSE (explosifs) **3 C570–C571; C451**
 Explosifs d'amorcage (Fr) **6 E360**
 Explosifs DD see DD explosifs **3 D19**
 Explosifs de Favier **1 A352**
 Explosifs deflagrants (Fr) **6 E361**
 Explosifs de demolition (Fr) **6 E361**
 Explosifs detonants (Fr) **6 E361**
 Explosifs fulminants (Fr) **6 E361**
 Explosifs N (nitrates) d'aluminum see Aluminum containing expls **1 A46**
 Explosifs a la nitrocellulose **6 E362**
 Explosifs N a la Pentolite **6 E362**
 Explosifs NR, explosifs du type NR or explosifs nitrates resistant a l'eau **6 E362**
 Explosifs O or OC **6 E363**
 Explosif 02 **6 E363**
 Explosifs 03 or promethees **6 E363**

- Explosif 04 or P 6 E363
- Explosif 05 6 E363
- Explosifs perchlorates see Perchlorate Cheddites
in 2 table 5, C159; 6 E363
- Explosifs plastiques 3 C438; 6 E363
- Explosifs et poudres 6 E363–E364
- Explosifs et poudres de Turpin 6 E366–E367
- Explosifs roche 6 E364
- Explosifs SGP 6 E364
- Explosifs au silicium 6 E364
- Explosifs de Sprengel 6 E364–E365
- Explosifs de surete (Belg & Fr) 6 E365–E366
- Explosion and combustion research at the
Hungarian Mining Research Institute
6 E369–E370
- Expln (and combustion) spherical 4 D549–D556
- Expln (and detonation), initiation (birth), and
propagation (growth or spread) in expl
substances 4 D402–D417
- Expln (and detonation) waves 4 D676–D682
- Expln (and expls) terminology 6 E387
- Expln and fire suppression techniques 6 E370
- Expln and its utilization 6 E393
- Expln at Lake Denmark Naval Ammunition Depot
located adjacent to PicArns, Dover, NJ
6 E374–E377
- Explosion autocatalytic 4 D225–D226
- Explosion, break character of 4 D226
- Explosion, breaking theory of Carl 4 D227–D228
- Explosion, bulge test 6 E368
- Expln by heat, flame and spark, initiation see
Detonation . . . in expl substances
4 D402–D417
- Expln by impact 4 D391 & Fig 45 D391
- Explosion by influence test 1 X; 4 D483–D491
- Expln by priming or boosting 4 D494
- Expln, chain reactions 4 D229
- Expln, combustion and shock waves see
Combustion, expln and shock waves 4 D172
- Expln, craters in 4 D242
- Expln, damage caused by 4 D245
- Expln, dangers (hazards) of 4 D245, D366 & D367
- Expln, dangers in chemical plants 4 D245
- Expln, dark waves in 4 D245
- Expln, decay in 4 D245
- Explosion see Detonation, expln and expls
4 D217–D223, D225–D732
- Expln, development from combustion or
deflagration 4 D245–D252
- Expln disasters, prevention of 6 E370–E371
- Expln, distant effect of 4 D252
- Expln, dynamics of 4 D255–D256
- Expln, effects of blast and shock waves on
structures 4 D256–D257
- Expln, effects of inert components on 6 E371
- Expln, effects of inert gases on the expln
delimitation of methane-air mixtures
6 E371
- Expln, effects of sheaths on gases from 6 E371
- Expln, effects of the physical structure and the
state of aggregation on the detonating
capacity of expls 6 E371
- Expln, effects produced in air, earth, and water
4 D257–D258
- Expln, electrical, electromagnetic and magnetic
effects accompanying it 4 D258–D264
- Expln, energy of 4 D264–D266
- Expln, enthalpy excess in 4 D267–D268
- Expln, enthalpy in 4 D265
- Expln, entropy in 4 D265
- Expln, equations of state in 4 D268
- Expln, expanding-jet theory of Jones
4 D460–D461
- Expln, experimental data interpretation of 4 D299
- Expln, experimental procedures 4 D299–D346

- Explan, gap tests in 4 D303–D304
- Explan hazards (dangers) of 4 D366–D367, D245
- Explan hazard of organic vapors, reduction of 6 E373
- Explan hazards from use of coal dust see Coal dust explan hazards from its uses 3 C359
- Explan, heat sensitization of expls and memory effect see Detonation, heat, sensitization of expls and memory effect on 4 D367–D369
- Explan; heats of formation, combustion, deflagration, explan and detonation 4 D369–D384
- Explan, impetus and available energy of 4 D391
- Explan, impulse effects on solids 6 E374
- Explan, impulse in 4 D393
- Explan, impulse specific 4 D394
- Explan, induction period in initiation of expls and proplnts 4 D394–D395; 6 E374
- Explan, initiation and shock processes 4 D417–D419
- Explan in granular expls see Detonation in granular expls 4 D365–D366
- Explan in media of variable density 4 D441
- Explan in mixing house of a fireworks plant 6 E378
- Explan, jet-piercing theory of 4 D467
- Explan, lateral dispersion (expansion) and lateral loss in 4 D421–D423
- Explan, lateral rarefaction wave 4 D364
- Explan, light (flame) accompanying it see Detonation . . . luminosity . . . produced on 4 D425–D434
- Explan limits determination from a unified thermal and chain theory 6 E377
- Explan limits in condensed expls 4 D424
- Explan, luminosity produced on 4 D425–D434
- Explan, mechanical effects of 4 D441
- Explan, mechanism of 4 D441
- Explan, memory effect 4 D368
- Explan, Mikhelson-Rayleigh straight line 4 D354
- Explan, mining effects see Blast effects in earth 2 B182–B183; Crater . . . effect 3 C553, C554
- Explan, nitrogen reaction in 6 E378–E379
- Explan, nozzle theory of Jones 4 D460–D461
- Explosion of ammoniacal silver compds and their solutions 1 A305–A306; 6 E367–E368
- Explosion of coal dust and/or firedamp see Coal mine explns and fires 3 C360–C367
- Explosion of coal gas 6 E369
- Explosion of combustible substances and transition from combustion to detonation 4 D245–D252; 6 E369
- Explan of composite expls 4 D232
- Explan of composite proplnt 4 D238
- Explan of condensed expls 4 D238
- Explan of dusts, mists and vapors 4 D253–D255
- Explan of liquid expls 4 D424–D425; 6 E378
- Explan of powdery expl charges 4 D475–D476
- Explan of S-IV all system vehicles, investigation of 6 E385
- Explan of shells and bombs 6 E385
- Explan of TNT plant at Saint Chamas, Fr 6 E389
- Explan of Trinitronaphthalene plant at Saint Chamas, Fr 6 E389
- Explan-operated tool 6 E379
- Explan (or detonation) by influence or sympathetic detonation and tests 4 D395–D402
- Explosion (or ignition) temperature test 1 XI, XVI–XVII; see Detonation (and explosion) temperature and its determination 4 D583–D589
- Explan parameters and characteristics 4 D463–D464
- Explan, particle size effect in see Detonation, particle size effect in 4 D465–D466
- Explan, penetrating jet theory of Apin 4 D467–D470
- Explan, phenomena accompanying it 4 D471

- Expln phenomenology 6 E379
- Expln physics 6 E379
- Expln, physics of 6 E379–E380
- Expln, polytropic curve and polytropic law
4 D474–D475
- Expln power or strength 4 D476–D479
- Expln, premature 6 E383
- Expln pressures and their measurements 6 E383
- Expln process, the hypothetical rate in 6 E384
- Expln products of 4 D494–D495
- Expln propagation thru expl charges
4 D497–D498
- Expln propagation thru layers of non-expl
substances 4 D498
- Expln properties and blasting action of HE 6 E384
- Expln, protection in 6 E384
- Expln pulping 6 E384
- Expln, rarefaction effect in air blast 2 B180
- Expln, rarefaction wave and release wave of
E.M. Pugh 4 D500–D502
- Expln reaction during reduction of fluorinated
compounds with LiAlH_4 6 E384
- Expln reactions; physico-chemical investigation of
6 E384
- Expln, resistance to 4 D508–D510
- Expln retardation 6 E385
- Explns by hot wires 6 E373
- Explns by static electricity initiated,
demonstration of 6 E386
- Explns, elements of risk in 6 E372
- Explns-gaseous, kinetic studies of 6 E372
- Explns, high altitude effects 6 E373
- Explns, history of 6 E373
- Expln, shock wave in 4 D530–D542
- Explns, homogeneity by flash photolysis 6 E373
- Explns in coal mines 3 C360–C367
- Explns in gases 4 D351–D360
- Explns in gases. Determination of ignition points
4 D360
- Explns in ice 6 E373–E374
- Explns in mines from Al, Mg, or steel sparks
6 E378
- Explns in mines, review 6 E378
- Explns in narrow tubes, self-acceleration of
spark-ignited 6 E378
- Explns in space 6 E385
- Explns in vacuo 6 E393
- Explns, nuclear (or atomic) 1 A501; 4 D461
- Explns of dusts 5 D1578
- Explns of electrostatic origin in industry,
prevention of 6 E372
- Explns of gases, vapors, and dusts. Development
(transition) from burning (combustion) or
deflagration 4 D360–D363
- Explns of Ti in HNO_3 and Zr in HNO_3 6 E388
- Expln spectra and spectrographic measurements
4 D548–D549
- Expln spectra of metals 6 E385–E386
- Expln spherical; initial behavior of 6 E386
- Expln, spontaneous 4 D561–D563
- Explns; relation between hardness, mp and
sensitivity 6 E384–E385
- Explns, review 6 E385
- Expln, stability and instability of 4 D569–D574
- Expln-state products of Dynamite, TNT, LDX and
AN expls 6 E386
- Explns, unexpected 6 E389–E390
at Firestone Tire 6 E390
at Olin Mathieson's, Brandenburg, Ky plant
6 E390
at Pittsburgh Metal Purifying Co 6 E390
at US Industrial Chem plant 6 E389
from chlorinated rubber-zinc oxide reaction
6 E390
of methyl ethyl ketone 6 E389–E390
of POCl_3 in the lab 6 E389

- Explns, unexpected (cont'd)
of the Olin Mathiesen's Co plant at Lake Charles, La 6 E390
at Sinclair Oil depot 6 E390
- Explns, uninvited 6 E390–E392
- Explns, unique 6 E392
- Explns, unsteady 4 D575
- Expln, suppression system 6 E386–E387
- Expln, sympathetic or expln by influence 4 D395–D402
- Expln temperature and its determination 1 XVI; 4 D583–D589
- Expln temperature determination as conducted at PicArns 6 E387
- Expln temperature determination by Rumpff's method 6 E387
- Expln, temperature developed on 4 D589–D601; 6 E387
- Expln, temperature developed on calculation for permissible expls 3 C445–C449
- Expln theories 4 D601–D602; 6 E388
- Expln theories for gases 6 E388
- Expln, thermal theories and thermochemistry of 4 D619–D622; 6 E388
- Explosion time test (C temp) 1 XVII; see Explosion-time test of double-base propellants 6 E389
- Expln, underwater 4 D628–D629
- Expln unit operation 6 E392
- Expln velocity in gases 4 D663–D666
- Expln, velocity of 4 D629–D640
- Expln, work capacity in 4 D730
- Expl 4 D217–D223
- Expl 808 6 E393
- Expl 851 and 852 6 E393
- “Explosive accident/incident abstracts” 6 E393
- Expl actuator, re-chargeable 6 E394
- Expl actuator XE-16A 6 E394
- Expl and incendiary ammunition 6 E410–E415
- Expl and related properties including tests of expls and proplnts (listing of 100 such tests and location in Encycl) 6 E432–E439
- Expl area 6 E394
- Expl assembly and method of making it 6 E394
- Expl B&T no 21 (Victorite) 6 E395
- Expl bonding see Detaclad process 3 D96–D97
- Expl bonding analog 6 E395
- “Expl bonding gets biggest job yet” 6 E395
- Expl bonding, mechanism of 6 E395
- Expl bonding, nature of 6 E395
- “Expl bonding technique emerging in NASA plans” 6 E395–E396
- Expl branding iron 6 E396
- Expl BTM of Fleischnick 2 B319
- Expl bullets 2 B326, B331
- Expl C-4 3 C485; 6 E396
- Expl, Canadian 6 E396–E397
- Expl capsule 6 E397
- Expl cartridge 6 E397–E398
- Expl catapults 6 E398
- Expl characteristics, calculation of 6 E398
- Expl cladding 6 E398
- Expl combustion and deflagration 4 D371
- Expl composition 146-4-G 3 C474; 6 E399
- Expl composition A-5 3 C476–C477; 6 E399–E401
US military specification MIL-E-14970A (MU) (6 Sept 1970) 6 E399–E401
- Expl composition APX 1 A475
- Expl composition D-2 3 C488
- Expl composition H-6 6 E401; 7 H1, H25–H35
- Expl composition HBX type 6 E401; 7 H23–H35
- Expl composition HTA-3 6 E402; 7 H176–H178
- Expl composition Minol-2 6 E402; 8 M135–M143

- Expl composition NSX 6 E402; see Nitrostarch
8 N157-N162
- Expl composition of Gordon and Little 6 E401
- Expl composition of Hradel 6 E402
- Expl composition of Pyrochemie 6 E403
- Expl composition of Rinckenbach & Carroll 6 E403
- Expl composition of Sato 6 E403
- Expl composition of Scott 6 E403
- Expl composition of Tetrytols
6 E403; 9 T165-T166
- Expl composition of Torpex
6 E403; 9 T324, T328-T329
- Expl composition PB-RDX 6 E402; see PBX
8 P60-P77
- Expl composition PBX N-5 6 E402; see PBX
8 P67-P77
- Expl composition Picratol 52/48
6 E402; 8 P284-P285
- Expl composition PIPE 6 E403; 8 P303
- Expl composition Plumbatol
6 E403; 8 P314-P315
- Expl composition PLX (liq) 6 E403; 8 P315
- Expl composition PVA-4 6 E403; 8 P497
- Expl composition RIPE 6 E403; 9 R174
- Expl compositions 3 C464-C473; 6 E399
- Expl compositions I & II 3 C474; 6 E399
- Expl compositions A, A-2, A-3 and A-4
3 C474-C475
- Expl compositions B, B-2, B-3, B-4. B desensitized
and Cyclotols 3 C477-C482; 6 E401
- Expl compositions, brisant (of high density)
6 E401
- Expl compositions C, C-2, C-3 and C-4 (Harrisite)
3 C484-C488; 6 E401
- Expl compositions Cyclotols
3 C479-C480; 6 E401
- Expl compositions EL-387A and EL-387B of
DuPont Co 3 C488-C489
- Expl compositions for oil well gun perforators
6 E402
- Expl compositions from nitrated toluene and
naphthalene 6 E402
- Expl compositions HBX-1 and HBX-2
6 E401; 7 H23-H35
- Expl compositions HEX-24 and HEX-48
6 E401; 7 H73-H74
- Expl compositions MOX 6 E402; 7 M157-M159
- Expl compositions Octols 6 E402; 8 O16-O17
- Expl compositions of Monsanto Co 6 E402
- Expl compositions Pentolites
6 E402; 8 P133-P136
- Expl compositions PTX-1 and PTX-2
6 E403; 8 P495-P496
- Expl composition T-9 3 C490
- Expl composition Trimonite 6 E403; 9 T374
- Expl composition Tritonala 80/20
6 E403; 9 T396-T399
- Expl composition Veltex No 448 6 E403
- Expl D see Ammonium Picrate 8 P276-P279
- Expl decomposition, rate of 6 E404-E406
- Expl deflagration 4 D371-D372
- Expl devices, register of US manufacturers 6 E406
- Expl diode 6 E406-E407
- Expl disintegration, expl fracturing or expl
shattering 6 E407-E408
- Expl driven anchor 6 E408
- Expl driver 6 E408
- Expl effect of an expl 6 E408
- Expl emulsion 6 E408-E409
- Expl envelopes & packages 6 E409
- Expl evacuation, instant 6 E409-E410
- Expl fabrication of metals 6 E415-E418
- Expl, flexible of Kegler 6 E418-E419
- Expl force 3 C493; 4 D391-D392; 6 E419
- Expl fracturing for well stimulation 6 E419

- Expl gases 4 D352, D356 & D360; 6 E419
- Expl gas gun 6 E419
- Expl generators 6 E410–E420
- Expl initiation evaluation 6 E420
- Expl lead salts, formation of during manuf of TNT
6 D420
- Expl limits and flash point — derivation of
empirical equations for the lower expls 6 E420
- Explosively actuated tools 6 E420
- “Explosive metallurgy” 6 E420
- Expl metalworking, high velocity 6 E421
- Expl mixture, Fr and Span 6 E421
- Expl mixture of methanol-water-magnesium
(or aluminum) 6 E421
- Expl mixtures 6 E421
- Expl mixtures and phlegmatized expls, physical
methods for analyzing the components of
6 E422
- Expl mixtures, detonability of 6 E421–E422
- Expl mixtures, detonation of 4 D346
- Expl mixtures of gases, flame propagation in
6 E422
- Expl mixtures of high density 6 E422
- Expl mixtures of Koch 6 E422
- Expl mixtures of Streng and Kirschenbaum
6 E422
- Expl N 6 E422–E423
- Expl nitric esters, liquid 6 E423
- Explosiveness and constitution 6 E423
- Explosiveness of ammonia-oxygen mixts, danger of
6 E423
- Expl of Audrieth 6 E395
- Expl of Buccianelli 6 E396
- Expl of DuPont Co 6 E408
- Expl of Holt and Hispano Suiza SA 6 E420
- Expl of Iroda 6 E420
- Expl operated valve 6 E423
- Expl or blasting oil 6 E423
- Expl or detonating compositions of Mediavilla
6 E406
- Expl output testing 6 E423–E424
- Expl papers 6 E424
- Expl PB-RDX see PBX 8 P61–P77
- Expl performance, comparison of two methods
for its evaluation 6 E424–E429
- Expl phenomena and detonation 4 E346
- Explosive pin 5 D1112–D1113
- Expl pipe closure system 6 E429–E430
- Expl power 1 XX
- Expl power vs oxygen balance, correlation of
6 E430
- Expl pressure 6 E430–E431
- Expl product laser 6 E431–E432
- Expl properties and decomposition derivs of
acetylene hydrocarbons 6 E439
- Expl properties of initiating expls 6 E439
- Expl properties of mixtures of organic substances
with nitric and perchloric acid 6 E439
- Expl properties 6 E439
- Expl reactions 6 E440–E441
- Expl reactions, theories of
4 D601–D629; 6 E441–E442
- Expl rivets or other fastening devices
6 E442–E445
- Explosives 6 E453–E454
expls, initiating 6 E454
expls, priming 6 E454
- Expl “salex” 6 E445
- Expls, color identification by see Color reactions
and color reagents 3 C405–C420
- Expls consumption 6 E489
- Expls containing Nitrostarch 6 E489–E490
- Expls containing paraffin and gasoline 6 E490
- Expl screw 6 E445
- Expl seam welding 6 E445–E446

- Expl sensitivity data 6 E446
- Expls, high density 6 E489
- Expl shocks in air 6 E446
- Expls, improvised 6 E489
- Expls, introduction to 6 E489
- Expls, listed in vols 1–5 of Encycl 6 E454–E458
- Expls, listing of books and pamphlets on 6 E455–E458
- Expl slurries 6 E446
- Expl slurry mixed on-site in canal job 6 E446–E447
- Expls, non-military (listing of papers and reports on commercial) 6 E463–E482
- Expls of military interest (listing of papers and reports) 6 E459–E463
- Expls R&D, history of 6 E490
- Expls sensitivity data 6 E490
- Expl starter 6 E447
- Expl stimulus transfer 6 E447
- Expl streamers 6 E447
- Expl substances vs thermites 6 E448
- Expl switch 6 E448–E450
- Expl systems, liquid, sensitivity characteristics of 6 E451
- Expl test 6 E451
- Expl testing in Europe, standardization of 6 E451
- Expl train 4 E836–D839; 6 E451
- Expl trains 6 E490–E491
- Expl wave shaping by delayed detonation 6 E451
- Expl welding 6 E451–E453
- “Explosive working on metals” 6 E453
- Explosivo num 3 3 C455; 6 E491
- Explosivos acidos 6 E491
- Explosivos antigrisu 6 E491
- Explosivos de seguridad 6 E491
- Explosivos de seguridad de la fabrica de Dinamita de Galdacano 6 E491
- Explosivos F.E. 6 E491
- Explosophore 1 A513–A514
- Explotron 6 E491–E495
- Expression 6 E495–E496
- Exsudation (Fr) 6 E496
- Exsudation essais (Fr) 1 XI
- Exsudation par etuvage 1 XI
- Extending of gelatin-Dynamites 6 E496–E497
- Extensometer for testing high expl materials 6 E497
- Extent of propagation of explosion (test) 1 VII, XI; 4 D402–D417, D497–D498; 6 E497
- Exterior ballistics 2 B7–B8
- Extinction of detonation 4 D223–D225
- Extinguishers for incendiaries 6 E497
- Extra carbonit 6 E500
- Extraction and distribution or partition 6 E497–E498
- Extractions used in expls labs and plants 6 E498–E500
- Extra-Dynamite of Nobel 6 E500
- “Extra” Dynamites (Amer) 6 E500
- Extra Dynamites 1 A295
- “Extra” Dynamites “Red Cross” of DuPont & Co 6 E500
- Extralite 6 E500
- Extraneous electricity, hazards of 5 E35–E55
- Extra powder 6 E501
- Extruders 6 E501
- Extrusion of metals, plastics, expls and proplnts 6 E501–E504
- Exudation in cast expls in presence of crack-preventing additives 1 A461–A462
- Exudation in expls 6 E504

Exudation in shells loaded with grade II TNT
and Amatol 6 E504–E506

Exudation (or sweating) tests 1 XI

Exudation tests for TNT and Amatoms
6 E507–E508

Exudation tests in Dynamites 6 E506–E507

Eye bombs (US Navy) 6 E508

Eyring absolute reaction rate theory see
“Absolute rate theory” 1 A4; 6 E508

Eyring (detonation) equation of state 4 D277

Eyring detonation theory see “Detonation curved
front theory of Eyring et al” 4 D242–D244

EZ44 see Entlastungszunder 5 E102

F1**F**

- "F" 6 F1
"F" (Dynamit) 3 C443
F (proplnts) 6 F1
"F" (proplnts) 6 F1
F1 6 F2
F33B 6 F2
FA-878 6 F2
Fabric cordeau 6 F2
"Factors affecting detonation velocities of desensitized NG in simulated underground fractures" 6 F2
Factors influencing velocity and other properties of expls 4 D347
"Factors in selecting and applying commercial expls and blasting agents" 6 F2
Fading of detonation in cones of expls 6 F2
Fading of detonation in solid expls 6 F2
Fading or fadeout of detonation 4 D223
FAE and FAX 6 F3-F4
Fahneljelm 6 F4
Fahrenheit, G.D. 6 F4
Fahrm's expl (Fr) 6 F5
Failure analysis 6 F5
Failure density 6 F5
Failure in detonation see Fading or fadeout of detonation 4 D223
Failure in detonation of coal mining expls 4 D347
Failure diameter 6 F5
Failure length of propagation of detonation 4 D199-D201
Fajans, Kasimir 6 F5
Falcon and falconet 6 F5
Falcon 6 F6
Falkenstein, K. von 6 F6
Fallenstein & Petry 6 F6
Fallex 6 F6
Fallhammerprobe (Ger) see Impact sensitivity or shock sensitivity test 1 XVII and FI 1 XII; 4 D304
Falling ball test (Atlas Chemical Ind) 6 F6
Falling ball test (Kankakee Ordnance Plant) 6 F6
Falling weight test 1 XVII; 5 D1550-D1555; Refs on impact 4 D391
Fallout see Atomic energy 1 A502
False ogive see Ballistic cap 2 B5
Fanno line and Rayleigh-Mikkell'son line 4 D348
Fans and blowers 6 F6-F7
Farad 6 F7
Faraday (F) 6 F7
Faraday, Michael 6 F7
Farmer's Dynamite 6 F7
Farmer's test for stability see Vacuum stability test 1 XXVI
Fasan powder 6 F7
FASP 6 F7
Fast burning gasless mixture 6 F7
Fast neutron activation facility at PA 6 F7-F8
Fast photography see Cameras, high-speed photography 2 C13-C19
Fast reactions in solids 6 F8
Fats, fatty oils, tallows, butters, waxes and fatty acids 6 F8-F9
Faure, Mackie & Trench 6 F9
Faustpatrone (Ger) 6 F9
Faversham mixture 6 F9
Faversham powders 6 F9-F10

- Favier expls 6 F10–F11
 Favorit 6 F11
 F-bomb 6 F11
 F.E.-1, F.E.-2 and F.E.-3 6 F11
 Federal fireworks regulations 6 F12
 Fedoroff, Basil T. 6 F12
 Feeders and feeding mechanisms 6 F12
 Fehleisen 6 F12
 Fehleisen & Andre 6 F13
 Fehling, Herman von 6 F12–F13
 Feigl, Fritz 6 F13
 Felhoen powder 6 F13
 Felixdorf factory Ammonals 1 A289 (table)
 Felixites 6 F13
 Fenchone 6 F13
 Fenian fire 6 F13
 Fenices 6 F14
 Fenton's powders 6 F14
 "Ferdinand" 6 F14
 Fergusonite 6 F14
 Fermentation 6 F14
 Fermentol 6 F14
 Ferric azide 1 A543
 Ferric azide, basic 1 A543
 Ferric ferrocyanide 6 F14–F15
 Ferric fluoride 6 F133
 Ferric nitrate 6 F15
 Ferric oxide 6 F15
 Ferric potassium sulfate 1 A156–A157
 Ferric triazide see Ferric azide 1 A543
 Ferricyanides 6 F15
 Ferri-ferrous oxide 6 F15
 Ferrifracteur 6 F15
 Ferrite 6 F15
 Ferro-alloys, chrome metal, and spiegeleisen 6 F15
 Ferroboron 6 F16
 Ferrocene 6 F16
 Ferrochromium 6 F16
 Ferroconcrete 6 F16
 Ferrocyanides 6 F16
 Ferrosilicons 6 F16–F17
 Ferrous acetylide see Iron acetylide 1 A76
 Ferrous ammonium sulfate 6 F17
 Ferrous azide 1 A543
 Ferrous carbide see Iron carbide 1 A76
 Ferrous fluoride 6 F133–F134
 Ferrous oxide 6 F17
 Ferrous sulfate 6 F17
 Ferrous sulfate and ferrous ammonium sulfate
 in detn of nitrates 6 F17–F19
 Ferrous sulfide 6 F19
 Fertilizer distributed by expls 6 F19
 Fertilizer recovered from expls 6 F19
 Fescolizing of shots 6 F19
 Feu (Fr) 6 F19
 Feu d'artifice (Fr) 6 F19
 Feu de canon (Fr) 6 F19
 Feu gregeois (Fr) 6 F19
 Feu grisou (Fr) 6 F19
 Feu liquide (Fr) 6 F19
 Feu lorrain (Fr) 6 F19
 Feu prussien (Fr) 6 F19
 FF-30 6 F20
 FGAN same as Ammonium nitrate fertilizer grade
 1 A359–A362, A364–A367
 F.G. powder 6 F20
 Fiber or fibre 6 F20
 Fickett (detonation) equation of state 4 D277

- Fickett equation of state based on intermolecular potentials 4 D277
- Fickett-Wood equation of state see "Constant- β and constant- α equations of state" 4 D275
- Fickett-Wood-Salsburg discussion on equation of state based on intermolecular potentials 6 E20
- Field chronograph test 3 C310
- Field clearing with Dynamite or other expls 6 F20
- Fieldier expl 6 F20–F21
- Fieldner, Arno C., Dr 6 F21
- Field parachute drop test for fuzes 4 D1093
- Field-proof gun 6 F21
- Field samples of permissible expls 3 C376
- Field testing of expls 6 F21–F24
- Figure of insensitiveness test 1 XII; 6 F39–F40
- Figure of merit 6 F24
- Filage (etirage) des poudres 6 F24
- Filite 6 F24
- Filler 6 F24–F25
- Filler or bursting charge 2 C150; 6 F25
- Film bridge initiators 6 F25
- Filtration, filter aids and filter mediums 6 F25–F26
- Filup 6 F26
- Fineness 6 F26
- Fineness of grind 6 F26
- Finissage des poudres 6 F26
- Fin stabilization and spin stabilization 6 F27
- fi p 6 F80–F96
- Fire 6 F27–F28
- Fire aboard USS Forrestal in 1967 6 F28
- Firearm 6 F28
- Fire balls 6 F28–F29
- Fire bombs 4 D944–D948
- Fire bombs, fillings 4 D941–D944; 6 F29
- Fire control 6 F29
- Firedamp 6 F29
- Firedamp Dynamite 6 F29
- Firedamp explns 6 F29–F30
- Firedamp-proof detonators 6 F30
- Firedamp-proof expls 6 F30
- Firedamp recovery 6 F30
- Fire, Greek 6 F31
- Fire hazards, uncommon 6 F31
- Fire point 6 F80–F96
- Fire resistance tests 1 XII–XIII; 6 F31
- Fire resistant coatings for bombs 6 F31
- Fire resistant textiles 6 F31–F32
- Fire retardant paints 6 F32–F33
- Fires and explns 6 F33
- Fires and explns in industries 6 F33
- Fires and explns of ammonium nitrate including FGAN 1 A35–AA363
- Fires and spontaneous ignitions 6 F34
- Fires, extinguishing (by explns) 6 F33
- Fires in coal mines 3 C360
- Fires-radioactivity and the detection of fires 6 F34
- Fire starter M1, used in pyrots 4 D762
- Fireworks 6 F34
- Fireworks art displays of Barry Rothman 6 F35
- Firing composition 121 6 F35
- Firing current required to ignite or detonate an initiating device 6 F35–F36
- Firing devices 4 D769–D773
- Firing of blasting expls 6 F35
- Firing pin 6 F36–F37
- Firing range 6 F37
- Firing station, guided missile 6 F37
- Firing systems 6 F37

- Firing time 6 F37–F38
- First aid 6 F38
- First-fire 6 F38
- First fire compositions in igniters 4 D759; 6 F38
- First fire, igniter and starter mixtures used in pyrots 4 D763–D767; 6 F38
- First fires, igniters and starters in pyrots 4 D760; 6 F39
- Fischer, Karl 5 D1622; 6 F39
- Fischer-Tropsch, Ruhrchemie synthesis 6 F39
- Fisher melting point apparatus 6 F39
- Fission bomb 1 A499
- Fission reaction 1 A501
- Fitch & Reunert 1 A171; 6 F39
- FI test 1 XII; 6 F39–F40
- Five-foot drop test 4 D1093
- Fivolite 6 F40–F41
- Fivonite see Nitrocyclopentanone 3 C604; 6 F41
- Fixed and semifixed ammunition and their comparison with separate-loaded ammunition 1 A358; 2 C74–C75; 4 D777–D792
- Fixed and semifixed ammunition, rounds of 6 F42
- Fixed and semi-fixed ammunition testing and surveillance 6 F42–F43
- Fixed particle size and shape expls 6 F43
- Fixed round of artillery ammunition, expl train in 4 D839
- Fk 6 F43
- Flaking 6 F44
- Flame 6 F44
- Flame; behavior towards it by expls 6 F47
- Flame, extinction of 6 F47
- Flame length and duration measurements 6 F47–F49
- Flameless cartridge case of Cocking 3 C388; 6 F49
- Flameless cartridge cases (Amer & Ger) 6 F50
- Flameless gas-producing charges 6 F50
- Flamelessite 6 F50
- Flameless securities 6 F50
- Flame, miscellaneous subjects (listing) 6 F50
- Flame of expln 6 F45–F47
- Flame or light accompanying detonation 4 D425–D434
- Flame photometry 6 F51
- Flameproof compounds 6 F51
- Flame propagation and velocity (Refs listing) 6 F51–F52
- Flame tests for detonators 6 F54
- Flame tests 1 XII, XVII, XXIII; 5 E138; 6 F54
- Flame theories 6 F54
- Flame thrower-M132A 6 F60
- Flamethrower, portable for lighting fuses 4 D1632
- Flame throwers 6 F54–F56
- Flame throwers - liquids and gels 6 F56–F59
- Flaming bayonet 6 F60
- Flaming thermit 6 F60
- Flammability 5 D211–D213
- Flammability and explosibility of dusts 4 D154–D163; 5 D1578–D1579
- Flammability and ignition 5 D348; 6 F60
- Flammability characteristics of combustible gases and vapors 5 D348; 6 F60
- Flammability index 1 XVII; 6 F60
- Flammability limits of methanol-air mixtures, the effect of water-vapor on 6 F60
- Flammability of Black Powder igniter bag 6 F60
- Flammability of expls, proplnts and pyrot compositions 4 D211–D213
- Flammability of NC 6 F60–F61
- Flammability of plastics 6 F61
- Flammability of powders 6 F61
- Flammability of proplnt 6 F61

- Flammability ranges and spontaneous ignition of some fuels in air 6 F61
- Flammability, surface, of materials: measuring it by using a radiant energy source 6 F61
- Flammability test for thin flexible materials 6 F61
- Flammable inhibitors can prevent explns in chemical plants 6 F61
- Flammable mass 6 F61
- Flammable materials, storage and handling 6 F61
- Flammbombe 6 F62
- Flammenausloschzusatz (Ger) 6 F62
- Flamminvores 6 F62
- Flammocite 6 F62
- Flanschgeschoss 6 F62
- Flares 6 F63–F69; 8 P505–P507
- Flareback or backfire 2 B2–B3
- Flare, float and flare, surface 6 F70
- Flare, German 6 F70–F72
- Flare, guide 6 F72
- Flare, guided missile 6 F72
- Flare, illumination 6 F72–F73
- Flare, long burning 6 F73
- Flare, magnesium 6 F73
- Flare, parachute 6 F73
- Flare, parachute, hand fired 6 F73
- Flare pistol, pyrotechnic pistol or Very pistol 6 F73
- Flares, pyrotechnic for cloud seeding 6 F73
- Flare, reconnaissance 6 F74
- Flare system, pyrotechnic 6 F74
- Flash 6 F74
- Flash 6 F74
- Flash-across, heat pulse and hypervelocity phenomena in detonation 4 D348–D349
- Flash and fire points by Cleveland open cup method 6 F80–F82
- Flash and flame 6 F74–F75
- Flashback 2 B2–B3
- Flashback tube 6 F75
- Flashbomb see Bombs, pyrot 2 B229; Pyrotechnics 8 P515
- Flash charge 6 F75
- Flash charge of electric squib 6 F75–F76
- Flash composition-lined smokeless proplnt loaded cartridge shells 6 F76–F77
- Flash depressor 6 F77
- Flash distillation 6 F77
- Flashes, ignition and progation of 6 F78
- Flash fuse 6 F77
- Flash hider 6 F77
- Flashing bullets 6 F78
- Flashing of expl substances 6 F78–F79
- Flashing test 6 F79
- Flashless 6 F79
- Flashless ballistite 6 F79
- Flashless cordites 6 F79
- Flashless gunpowder 6 F79
- Flashless mortar-type sheet of proplnt 6 F79
- Flashless nonhygroscopic proplnt see Cannon proplnt 2 C32
- Flashless proplnt “Albanite” (US Navy) 1 A119
- Flashless proplnt “gudolpulver” (Ger) 5 D1537–D1538; 6 F80
- Flashless proplnt of Gallowitz, called “G” pulver (Ger) 3 C511; 5 D1536–D1537; 6 F80
- Flashless proplnt of Kincaid & McGill 6 F80
- Flashless smokeless proplnt of Barsky 6 F80
- Flashlight for use in photography 1 C14; 6 F80
- Flash photography 2 C14
- Flash photography without battery 6 F77–F78
- Flash photolysis 6 F80

- Flash point 6 F80–F96
 flash and fire points by Cleveland open cup method (COC) 6 F80–F82
 flash point of liquids by Pensky-Martens closed tester 6 F90–F96
 flash point of liquids by TAG closed tester 6 F88–F90
 flash point of liquids by TAG open cup apparatus 6 F82–F88
- Flash point of liquids by Pensky-Martens closed tester 6 F90–F96
- Flash point of liquids by TAG closed tester 6 F88–F90
- Flash points of liquids by TAG open cup apparatus 6 F82–F88
- Flash point tests 1 XVI–XVII; 6 F80–F96
 flash and fire points by Cleveland open cup method 6 F80–F82
 flashpoint 6 F80
 flash point of liquids by TAG closed tester 6 F88–F90
 flash points of liquids by TAG open cup apparatus 6 F82–F88
 flash point of liquids, Pensky-Martens closed tester 6 F90–F96
- Flash radiography of high-speed events 2 C17
- Flash reducer 6 F96
- Flash-reducing agents 6 F96–F98
- Flash reduction in Ger projectiles 6 F99
- Flash reduction in Ger proplnts 6 F99–F100
- Flash suppressor 6 F100
- Flash test for caps see Optical method for testing caps 1 XIX
- Flash tubes 6 F100
- Flat plate test and cylinder test 6 F100–F101
- Flavanone 6 F101
- Flavone 6 F102
- Fleche (Fr) 6 F102
- Flechette (Fr) 6 F102
- Flechette (US) or aerial dart 6 F102–F106
- Flegmatizatory (Rus) see Erosion of gun barrel 5 E112–E120; 6 F106
- Flegmatizirovannyi Gheksoghen 6 F106
- Flegmatizirovannyi TEN 6 F106
- Felgmatizirovannyi Trotil 6 F106
- Flerlet powder 6 F106
- Flexed TNT 6 F106–F107
- Flexible expls 6 F107
- Flexible hollow spheres 6 F107
- Flex test for barrier materials 6 F107
- FLEX-X 3 D99–D101; 6 F107
- Flintlock or firelock 6 F107–F108
- Flobert rifle and ammunition 6 F108
- Flocculation 6 F108
- Flogel 6 F108
- Flotation or froth flotation 6 F109–F109
- Flo-turn process for forming shell bodies 6 F109–F110
- Flour 6 F110
- Flour, cellulosic 6 F110
- Flour tester 6 F110
- Flow laws of detonation 6 F110
- Flow velocity in shock 4 D516–D517
- Flow velocity of the detonation products of expls 6 F110–F111
- Flox 6 F111
- fl p 6 F80–F96
- Fluctuating velocity in detonation wave 4 D728
- Flueric expl initiator 6 F111
- Flueric safety and arming of selected ammunition 6 F111
- Flugkorper (Ger) 6 F111
- Flugzeugtrager (Ger) 6 F111
- Fluid actuator 6 F111
- “Fluid ball” 6 F111

- Fluid expls, reactions following initiation of
6 F111
- Fluid flow 6 F111
- Fluidic expl initiator 6 F111)F118
- Fluidize 6 F118
- Fluid mechanics or dynamics and hydraulics
6 F118–F119
- Fluid transportation 6 F119
- Fluo- or fluoro- 6 F119
- Fluoran and derivs 6 F119–F120
x,x,x,x,x-pentanitrofluoran 6 F119–F120
- Fluoranthene and derivs 6 F120
dinitrofluoranthenes 6 F120
mononitrofluoranthenes 6 F120
pentanitrofluoranthene 6 F120
tetranitrofluoranthene 6 F120
trinitrofluoranthene 6 F120
- “Fluorel” brand 2141 elastomer 6 F120–F121
- Fluorene and derivs 6 F121–F122
azidofluorenes 6 F121
9,9-diazidofluorene 6 F121
9-diazo-x,x-dinitrofluorene 6 F122
9-diazofluorene 6 F121
9-diazo-2,4,7-trinitrofluorene 6 F122
dinitrofluorenes 6 F122
mononitrofluorenes 6 F122
9-nitratofluorene 6 F122
- Fluorenone and derivs 6 F122–F123
azidofluorenones 6 F122–F123
2,7-diazidofluorenone 6 F123
dinitrofluorenones 6 F123
mononitrofluorenones 6 F123
tetranitrofluorenones 6 F123
trinitrofluorenones 6 F123
- Fluorenone peroxide 6 F123–F124
- Fluorescein 6 F124
- Fluorescein 6 F125
- Fluoresceinates 6 F124
- Fluorescence, luminescence and phosphorescence
6 F124–F125
- Fluorescence spectroscopy and test 6 F125
- Fluorescent screen 6 F125
- Fluoric acid 6 F125
- Fluoride 6 F125
- Fluorimide 6 F134
- Fluorinated ethylene-propylene resin 6 F125
- Fluorinated paraffin 6 F125
- Fluorinated polymeric peroxides 6 F126
- Fluorinating agent 6 F126
- Fluorine 6 F126–F127
- Fluorine azide 1 A536
- Fluorine compounds 6 F134
- Fluorine derivs 6 F127–F151
Al fluoride anhydrous 6 F127
Al fluoride hydrate 6 F127
Al fluosilicate 6 F127
ammonium fluoride 6 F127
ammonium fluosilicate 6 F127
azido fluoride see Fluorine azide 1 A536
Ba fluoride 6 F127
Ba fluorosilicate 6 F128
benzotrifluoride 6 F128
Be fluoride 6 F128
Be-potassium fluoride 6 F128
Be-sodium fluoride 6 F128
B fluoride 6 F128
Br pentafluoride 6 F128
Br trifluoride 6 F128
bromodifluorethane 6 F129
bromotrifluorethylene (BFE) 6 F129
bromotrifluoromethane 6 F129
Ca fluoride 6 F129
Ca fluorosilicate 6 F129
carbon tetrafluoride 2 C64; 6 F129
carbonyl fluoride 6 F129
chlorine trifluoride 6 F129
chlorobenzotrifluorides 6 F129–F130
1-chloro-1,1-difluoroethane 6 F130
1-chloro-2,2-difluoroethane 6 F130
chlorodifluoromethane 6 F130
1-chloro-1,1,2-trifluoroethane 6 F130
2-chloro-1,1,2-trifluoroethylene (CFE) 6 F130
chlorotrifluorethylene resins 6 F130
chlorotrifluoromethane 6 F130
chromic fluoride 6 F131
cobaltous fluoride 6 F131
cobalt trifluoride 6 F131
copper fluoride 6 F131

Fluorine derivs (cont'd)

copper fluosilicate 6 F131
 cyanogen fluoride 6 F131
 1,1-dibromo-2,2-difluoroethane 6 F131
 1,2-dibromo-1,1-difluoroethane 6 F131
 dibromodifluoromethane 6 F131
 1,1-dichloro-2,2-difluoroethane 6 F131–F132
 1,2-dichloro-1,2-difluoroethylene 6 F132
 dichlorodifluoromethane 5 D1209; 6 F132
 dichlorofluoromethane 6 F132
 s-dichlorotetrafluoroethane 6 F132
 difluoramino compounds 5 D1258; 6 F132
 difluorenyl-diperoxide 5 D1258
 di (fluorenylidenehydro)-sym-tetrazine
 5 D1258
 difluorobenzene and derivs 5 D1258–D1259
 difluorodichloromethane 5 D1209; 6 D132
 difluorodiphenyltrichloroethane (DFDT)
 6 F132–F133
 1,2-difluoroethylene 6 F133
 1,2-difluoro-1,1,2,2-tetrachlorethane 6 F133
 dinitrogen difluoride 6 F133
 dinitrogen tetrafluoride 6 F133
 ethylene tetrafluoride 6 E291
 ethylfluoroformate 6 F133
 ferric fluoride 6 F133
 ferrous fluoride 6 F133–F134
 fluorimide 6 F134
 fluorine (explosif de Turpin) 6 E366
 fluorine azide 1 A536
 fluorine compounds (danger of expln) 6 F134
 fluorine fluorosulfate 6 F134
 fluorine nitrate 6 F134–F135
 fluorine organic materials oxide 6 F135
 fluorine oxide 6 F135
 fluorine ozonide 6 F135
 fluorine perchlorate 6 F135
 fluorine peroxide 6 F135
 fluorines of Turpin 6 E366–E367
 fluoroacetylene 6 F135–F136
 fluoroalcohols 6 F136
 fluoroaluminate of potassium 6 F136
 fluorobenzene and derivs 6 F136–F137
 fluorobenzoic acid and derivs 6 F137
 fluoroboric acid 6 F137
 fluorocarbon resins 6 F138
 fluorocarbons 6 F138
 fluorocarbon NF compounds 6 F138
 fluorochemicals 6 F138
 fluorochemistry and fluorometric analysis
 6 F138–F139

Fluorine derivs (cont'd)

fluoro compounds 6 F139
 fluoroethane 6 F139–F140
 fluoroethylene 6 F140
 fluoroform 6 F140
 "fluorolubes" 6 F140
 fluoromethane 6 F140
 fluorometry 6 F140
 fluoro-nitro compounds 6 F140
 fluorophenol and derivs 6 F140–F141
 fluoroscopy 6 F141
 fluorosilicates 6 F141
 fluorosilicic acid 6 F141–F142
 fluorothene 6 F142
 fluorotoluene and derivs 6 F142
 fluorotrichloromethane 6 F142
 "FREON" 6 F142–F143
 hydrogen fluoride 6 F127
 iodine fluoride 6 F143
 lead fluoride 6 F143
 lithium fluoride 6 F143
 magnesium fluoride 6 F143
 magnesium fluorsilicate 6 F144
 manganic fluoride 6 F144
 manganous fluoride 6 F144
 mercuric fluoride 6 F144
 molybdenum fluoride 6 F144
 nickel fluoride 6 F144
 nitrogen trifluoride 6 F144
 nitrosyl fluoride 6 F144–F145
 nitroxyl fluoride 6 F145
 octafluorocyclobutane 6 F145
 perfluoroethylene 6 E291
 peroxydisulfuryl difluoride 6 F145
 phosphorous pentafluoride 6 F145
 phosphorous trifluoride 6 F145
 potassium bifluoride 6 F145
 potassium borofluoride 6 F146
 potassium fluoride 6 F146
 potassium fluosilicate 6 F146
 rubidium fluoride 6 F146
 selenium tetrafluoride 6 F146
 silicofluoroform 6 F146
 silicon fluoride 6 F146–F147
 silver fluoride 6 F147
 sodium borofluoride 6 F147
 sodium fluoride 6 F147
 sodium fluorsilicate 6 F147
 stannic fluoride 6 F147
 stannous fluoride 6 F147
 strontium fluoride 6 F147

Fluorine derivs (cont'd)

- sulfur hexafluoride 6 F147
 - sulfuric oxyfluoride 6 F148
 - sulfurous oxyfluoride 6 F148
 - tetrafluorohydrazine 6 F148
 - tetrafluoromethane see Carbon tetrafluoride 2 C64
 - thorium tetrafluoride 6 F148
 - titanium tetrafluoride 6 F148
 - titanium trifluoride 6 F148–F149
 - 1,1,1-trichloro-1,2,2-trifluoroethane 6 F149
 - trifluoronitrosomethane 6 F149
 - tungsten hexafluoride 6 F149
 - uranium hexafluoride 6 F149; see Uranium compounds 10
 - uranium tetrafluoride 6 F149
 - vanadium pentafluoride 6 F150
 - vinylidene resins 6 F150; see in 10
 - vinylfluoride polymer 6 F150
 - zinc fluoride 6 F150
 - zinc fluorosilicate 6 F150
 - zirconium fluoride 6 F150
 - zirconium potassium fluoride 6 F150–F151
- Fluorine (explosifs de Turpin) 6 E366
- Fluorine fluorosulfate 6 F134
- Fluorine nitrate 6 F134–F135
- Fluorine organic materials 6 F135
- Fluorine oxide 6 F135
- Fluorine ozonide 6 F135
- Fluorine perchlorate 6 F135
- Fluorine peroxide 6 F135
- Fluorines of Turpin 6 F135
- Fluoroacetylene 6 F135–F136
- Fluoroalcohols 6 F136
- Fluoroaluminate of potassium 6 F136
- Fluorobenzene and derivs 6 F136–F137
- fluoro-2,4-dinitrobenzene 6 F137
 - fluoronitrobenzenes 6 F136–F137
 - fluoro-2,4,6-trinitrobenzene (TNFB) 6 F137
- Fluorobenzoic acid and derivs 6 F137
- 2-fluoro-4,5-dinitrobenzoic acid 6 F137
 - 2-fluoro-4-nitrobenzoic acid 6 F137
- Fluoroboric acid 6 F137
- Fluorocarbon NF compounds 6 F138
- Fluorocarbon resins 6 F138
- Fluorocarbons 6 F138
- Fluorochemicals 6 F138
- Fluorochemistry and fluorometric analysis 6 F138–F139
- Fluoro compounds 6 F139
- Fluoroethane 6 F139–F140
- Fluoroethylene 6 F140
- Fluoroform 6 F140
- “Fluorolubes” 6 F140
- Fluoromethane 6 F140
- Fluorometry 6 F140
- Fluoro-nitro compounds 6 F140
- Fluorophenol and derivs 6 F140
- fluorodinitrophenols 6 F141
 - fluoronitrophenols 6 F141
 - 3-fluoro-2,4,6-trinitrophenol, 3-fluoropicric acid 6 F141
- Fluoroscopy 6 F141
- Fluorosilicates 6 F141
- Fluoroethene 6 F142
- Fluorotoluene and derivs 6 F142
- fluoromononitrotoluene 6 F142
- Fluorotrchloromethane 6 F142
- Flussige tri (Ger & Swiss) 6 F151
- Fluted liners 6 F151
- Fly cotton 6 F151
- Flying spot microscope 6 F152
- FNH proplnts 6 F152
- Foamed expls for floating mine 6 F152
- Foams 5 E87; 6 F152
- FOBS 6 F152
- Fog 6 F153
- Fog acid 6 F153
- Fog point 6 F153

- Fohn gerat **6 F153**
- Folded head ammunition **6 F153**
- Folded head cartridge **4 D756**
- Folded skirt projectile **6 F153–F154**
- Follow-through projectile for shaped charges **6 F154**
- Fonberg phenomenon **6 F154**
- Fonckite V **6 F154**
- Fonction de progressivite experimentale (Fr) **6 F155**
- Fontaine powders **6 F155**
- Fontane, Nicola **6 F155**
- Fontano, Barely & de Choisy powder **6 F155**
- Forbidden expls (US Interstate Commerce Commission regulations) **6 F155–F156**
- Force and covolume of colloidal proplnts **6 F156**
- Force and impetus in detonation **4 D391–D393; 6 F156**
- Force brisante (Fr) **6 F156**
- Force constant **6 F156–F157**
- Force de l'explosif de Sarau **6 F157–F160**
- Force de penetration (Fr) **6 F160**
- Forcement dans les bouches a feu
- Force or impetus **4 D391**
- Force propulsive (Fr) **6 F160**
- Force specifique (Fr) **6 F160**
- Forcites **6 F160–F162**
- Fordit (Ger) **6 F162**
- Foreign ammunition and weapons **6 F162**
- Foreign artillery fuzes of WWII **4 D923–D925**
- Foreign bomb fuzes of WWII **4 D1008–D1010**
- Foreign cannon proplnts **2 C37**
- Foreign commercial expls **3 C437–C444, C444–C459**
- Forensic ballistics **6 F162**
- Forensic chemistry **6 F162–F163**
- Forensic science **6 F163**
- Forestry uses of expls **1 A114**
- Form and measurement of foreign proplnts **6 F163**
- Formaldehyde **6 F163–F164**
- Formaldehyde and derivs **6 F165–F167**
expls obtained directly from formaldehyde **6 F165**
expls obtained from derivs of formaldehyde **6 F165–F167**
- Formaldehyde polymers **6 F164–F165**
paraformaldehyde **6 F164; 8 P11 (expls)**
tetraoxymethylene **6 F165**
sym-trioxane **6 F164–F165**
- Formaldehyde peroxide see Dimethylol peroxide **5 D1357**
- Formaldehyde-starch mixture **6 F167**
- Formalin **6 F167**
- Formamide and derivs **6 F167**
- Formamide azide see Carbamyl azide **2 C40**
- Formamide hydrochloride **6 F168**
- Formamide perchlorate **6 F168**
- Formamidine **6 F168**
- Formamidines **6 F168–F169**
azidoformamidine nitrate **6 F168**
azidoformamidine perchlorate **6 F168**
azidoformamidine picrate **6 F169**
azidoformamidine sulfate **6 F168**
azido-N-nitroformamidine **6 F168–F169**
1,1'-azo-bis-nitroformamidine **6 F169**
1,1'-azodiformamidine dinitrate **6 F169**
1,1'-azodiformamidine dipicrate **6 F169**
bromoformamidine nitrate **6 F169**
bromoformamidine perchlorate **6 F169**
chloroformamidine nitrate **6 F169**
chloroformamidine perchlorate **6 F169**
- 4-Formamino-1,2,4-triazole **6 F169**
- Formation, heats of **4 D369–D370, D380–D381**
(tables A & B)
- Formazans and formazyls **6 F170**
N,N'-diphenylformazan-C-azobenzene **6 F170**
N,N'-diphenylformazan-C-carboxylic acid **6 F170**

- Formazans and formazyls (cont'd)
 N,N'-diphenylformazylglyoxylic acid 6 F170
 N,N'-diphenyl-C-nitroformazan 6 F170
- Form function 6 F170
- Formic acid and derivs 6 F170–F172
 azidoformic acid dimethylamide 6 F171
 azidoformic acid ethylester 6 F171
 azidoformic acid methylester 6 F171
 ethyl formate 6 E294
 methyl formate 6 F171
 sodium formate 6 F171
 zinc formate 6 F171–F172
- Formit 6 F172
- Formoguanamine 6 F172
- Formula 226 see Aluminum containing expls 1 A246
- Formulation of an expl 6 F172
- Formwar 6 F174
- Formyl expl compounds 6 F172–F173
 N-(α -azidoformylbutyl) glycine azide
 6 F172–F173
 o-(azidoformyl)-phenylisocyanate 6 F173
 N-(β -azidoformylpropionyl) glycine azide 6 F173
- Formylhydroperoxide 6 F173
- Formylglycerol and derivs 6 F173
- Formylglycerol dinitrate 6 F173
- 1-Formyl-2-picrylhydrazine 6 F173
- Forster (Von) 6 F174
- Fortex 6 F174
- Fortification 6 F174
- Fortification or revivification of acids 6 F174
- Fortis 6 F174–F175
- Fortisine 6 F175
- Forty-degree test for exudation of expls 6 F175
- Forty-foot drop test 4 D1093; 6 F175
- Forty-four degree test 1 XI
- Forty-two grain powder 6 F175–F176
- Fossano 6 F176
- Fossil flour 6 F176
- Fougas (Rus) 6 F176
- Fougasse (Fr) 6 F176
- Fougasse, incendiary fuels for 6 F176
- Fougasse (US) 6 F176
- Fouling of guns and antifouling agents 6 F176–F177
- Four cartridge test 1 XII; 4 D395–D402; 6 F177
- Fourcroy-Vaquelin detonation mixture 6 F177
- Fournier powder (Brit) 6 F177–F178
- Fowler dynamite 6 F178
- Foxhole 6 F178
- Foxhole expl digger 6 F178
- FP (Amer) 6 F178
- Fp (Ger) 6 F178
- Fp 02 6 F178
- Fp 88 6 F178
- Fp 60/40 6 F178
- fps (Amer) 6 F178
- Fractionation columns 6 F178–F179
- Fractorites 6 F179
- Fracturing by relative motion of load in detonation
 4 D544
- Fracturing by release of load in detonation
 4 D543–D544
- Fracturing by shear in detonation 4 D544–D545
- Fracturing in oil shale by expls 6 F179
- Fracturing of corner in detonation 4 D543
- Fracturing of metal in detonation or fracturing of
 metal under impact loading by high expls 4 D542
- Fracturing of rock by shock-wave in detonation
 4 D545–D546 (table 2)
- Frag 6 F179
- Fragmacord mine 6 F179–F180
- Fragment 6 F180
- Fragmentation 6 F180
- Fragmentation bombs 4 D933–D935

- Fragmentation characteristics **6 F180**
- Fragment concentration test **1 XII; 3 D84; 6 F180**
- Fragmentation, controlled **6 F180**
 warhead, continuous rod **6 F180**
 warhead, discrete rod **6 F180**
- Fragmentation density test **1 XII; 3 D84**
- Fragmentation grenades **6 F180–F181**
- Fragment gun **1 XII**
- Fragment gun test **1 XII; 2** see Table 1 under
 Brisance **B266–B295**
- Fragmentation tests in detonation **1 XII; 6 F181**
- Fragment velocity measurements **1 XIII;**
6 F181–F182
- Framing camera **2 C14**
- Franchimont, A.P.N. **6 F182**
- Franchimont reaction **6 F182**
- Francois Blondel **6 F182**
- Frangible ammunition **6 F182**
- Frangible hand grenade **6 F182–F183**
- Frank, Adolph **6 F183**
- Franke **6 F183**
- Frankel **6 F183**
- Frank expls **6 F183**
- Frankford Arsenal **6 F183**
- Frank-Kamenetskii thermal expln theory
6 F183–F184
- Frankland reaction **6 F184**
- Frankland, Sir Edward **6 F184**
- Franklin, Benjamin **6 F184**
- Franklin, Edward C. **6 F184**
- Franklin Institute (FI) **6 F184–F185**
- Franklin's method of electrical initiation **6 F185**
- Frantsuzskaya Smes' **6 F185**
- Franz's expl **6 F185–F186**
- Frary's metal **6 F186**
- "FRAS" **6 F186**
- Fraser & Callaghan **6 F186**
- Freeness (wetness) and its testing **6 F186**
- Free radical and free radical proplnts
6 F186–F187
- Free rocket **6 F187**
- Free run **6 F187**
- Free surface **4 D349**
- Free surface velocity method for detn of
 detonation pressure **4 D487–D488**
- Free volume theory of Lennard-Jones-Devonshire
 (LJD) **4 D349**
- Free volume theory of multicomponent fluid
 mixtures **4 D349; 6 F187**
- Free volume theory of the liquid state developed
 by Eyring et al and by Lennard-Jones-
 Devonshire **4 D349**
- Freezing of Dynamites and antifreezes see
 Dynamites **5 D1588–D1593**
- Freezing (frigorific) mixture or cooling bath
6 F187
- Freezing (solidification, congelation or setting)
 point (fr p) and its detn **6 F188**
- Freezing tests (for Dynamites) **1 XIII; 6 F188**
- Freiberg (poudre de mine de) **6 F188**
- Freins de bouche (Fr) **6 F188**
- Freins de tir (Fr) **6 F188**
- French Ammonals S and C **1 A290 (table)**
- French ammonium nitrate gelatin Dynamites
1 A368
- French ammunition and expls of WWII
6 F188–F190
- French anarchists expl (green powder) **6 F190**
- French armor **6 F190–F191**
- French commercial expls of nonpermissible type
3 C438; 6 F191
- French commercial expl of permissible type
3 C450–C451; 6 F191
- French compound **6 F191**

- French Cyclonite see Cyclotrimethylene-trinitramine 3 C615
- French Cyclonite binary and ternary mixtures 3 C626; 6 F191
- French demolition expls 3 D58–D59
- French Dynamites 6 F191–F194
 Dynamites a absorbant active 6 F192
 Dynamites a absorbant inerte 6 F191–F192
 Dynamites a faible taux de nitroglycerine qui se present sous form pulverulente 6 F193–F194
 Dynamites a gelatinisant active 6 F192
 Dynamites gelatinees 6 F192–F193
 Dynamites-gommes 6 F192
- French Dynamites and their substitutes 6 F194
- French expl industry of after WWII 6 F194
- French expls 6 F194
- French gap test 3 C390; 6 F194
- French gelatinized expls 6 F195
- French grisou-Dynamite 5 D1591 (table 1); 6 F195
- French ground-to-ground strategic ballistic missile 6 F195
- French lead block (Trauzl) test 1 IX–X; 6 F195
- French low-freezing Dynamites 6 F195
- French military expls, requirements 6 F195–F196
- French mixture 6 F195
- French safety expls 6 F196
- French test for hygroscopicity (LeRoux) 7 H252–H254
- French tests for expls and proplnts 6 F196–F200
- French verge gelatin 5 D1291 (table 1)
- French weapons of WWII 6 F200–F201
- “FREON” 6 F142–F143
- Frequency tailored transducers 6 F201
- Fresenius, Karl Remigus 6 F201
- Fresnel, Augustin Jean 6 F201
- Frettage 6 F202
- Friction and lubrication 6 F202
- Friction composition for blasting fuse 4 D1071
- Friction compositions for friction detonators, friction firing devices and friction igniters (primers) 6 F202–F203
- Friction detonators 6 F203
- Friction element moisture resistant 6 F203
- Friction firing devices 6 F203
- Friction; heat and percussion in relation to 6 F203
- Friction igniters or primers 6 F203–F204
- Friction impact test see Friction sensitivity test 1 XIII
- Friction sensitivity 6 F204
- Friction sensitivity tests 1 XII–XIV
 qualitative 6 F204
 quantitative 6 F204–F206
- Friedel-Crafts reaction 6 F206
- Friedler’s incendiary composition 6 F206
- Fringing groove 6 F206
- Frittage (Fr) 6 F206
- Front of detonation and shock front, also detonation zone and shock zone 4 D350–D351
- Front of detonation measurements 6 F206–F207
- Front of detonation, non-planar 4 D349–D350
- Front of reaction in detonation 4 D503
- Frothiness testing of TNT 1 A463–A464
- Frozen blasting gelatin 2 B211; 6 F207
- Frozen Dynamite 6 F207
- Frozen gravel blasting 6 F207
- Frozen Nitroglycerol 6 F207
- Fructosans 6 F207
- Fructosan trinitrate 6 F208
- Fructose (levulose) 6 F208
- Fs 6 F208
- FS 6 F208

- FS (chem) **6 F208**
 Fuchs (Clement) powder **3 C329**
 Fuel **6 F208–F209**
 Fuel cells **6 F209–F211**
 Fuel element **6 F211**
 Fuel oils (FO) and fuel containing expls
 6 F211–F213
 Fuel oils, analytical **6 F213**
 Fuel-oxidizer type proplnts **3 C464–C474**, see
 Composite proplnts **8 P409–P413**
 Fuels by hydrogenation of coal & coal tar
 3 C379–C380
 Fugacity **6 F213–F214**
 Fugacity determinations of the products of
 detonation **6 F214**
 Fugacity of products **4 D351**
 Fugasnost' or fugasnoye deystviye (Rus) **6 F214**
 Fugasnyi and oskolochnofugasnyi snariady **6 F214**
 Fuhrer **6 F214**
 Fuhrer's silicium expl **6 F214**
 Fulgor powders **6 F214–F215**
 Fulgurites **6 F215**
 Fuller's earth **6 F215**
 Fullung (fulpulver) (Fp or RP) **6 F215**
 Fulmenit (Ger) **6 F215**
 Fulmibois **6 F215**
 Fulmicoton **6 F215**
 Fulmicoton de Faversham (Tonite) **6 F215–F216**
 Fulmicoton, soluble (Fr) **6 F216**
 Fulminant d'argent (Fr) **6 F216**
 Fulminant d'argent de Berthollet (Fr) **6 F216**
 Fulminant d'argent de Brugnatelli (Fr) **6 F216**
 Fulminant d'or (Fr) **6 F216**
 Fulminant de platine (Fr) **6 F216**
 Fulminate blasting cap of Nobel see Dynamite
 5 D1588
 Fulminate chlorate (90/10) **6 F216**
 Fulminates **6 F216–F230**
 alkali fulminates **6 F216**
 ammonium silver fulminate **6 F216–F217**
 cadmium fulminate **6 F217**
 copper (1) fulminate **6 F217**
 copper (1) fulminate expl complexes **6 F217**
 mercuric fulminate **6 F217–F223, F226–F230**
 mercuric fulminate-sulfur compound **6 F223**
 mercuric pyrofulminate **6 F223**
 potassium fulminate **6 F223**
 potassium-silver fulminate **6 F223**
 silver fulminate **6 F223–F224**
 silver fulminate (SF) and telescopic mirrors
 6 F224–F225
 sodium cuprous fulminate **6 F225**
 sodium fulminate **6 F225**
 thallium fulminate **6 F225–F226**
 Fulminating **6 F231**
 Fulminating compounds **6 F231**
 Fulminatin (Ger) **6 F234**
 Fulminating gold (FG) **6 F231–F232**
 Fulminating mercury **6 F232**
 Fulminating platinum (FP) **6 F232**
 Fulminating powder of Forsyth **6 F232**
 Fulminating powders described by Davis **6 F233**
 Fulminating powders, history **6 F233–F234**
 Fulminating silver of Berthollet **6 F234**
 Fulminative **6 F230**
 Fulminic acid **6 F234–F235**
 Fulminuric acid **6 F235**
 Fulmipaille (Paleine) **6 F235**
 Fulmison **6 F235**
 Fulmitriguanurate **6 F235**
 Fuloph & Lackovic expl (Hung) **6 F235**
 Fumaric acid and derivs **6 F235–F236**
 fumaric acid diazide **6 F235–F236**
 fumaric acid peroxide **6 F236**
 Fume characteristics **6 F236**
 Fumee (Fr) **6 F236**

- Fumee, poudres sans (Fr) 6 F236
- Fumelessite 6 F236
- Fume-off 6 F236
- Fume recovery at US plants manufacturing NC 6 F236
- Fume tests (NC stability tests) 6 F236–F238
- Fumigene (Fr) 6 F238
- Fumigene, compositions (Fr) 6 F238–F239
- Fuming nitric acids 6 F239
- Fumyl 6 F239
- Function and casualty tests of small arms ammunition 6 F239
- Function on arming test (FOA test) 6 F239
- Fungus resistance test for fuzes 4 D1094; 6 F239
- Funkenchronograph (Ger) 6 F239
- Funkenkinematographie (Ger) 6 F239
- Funkenphotographie (Ger) 6 F239
- Funkenzunder (Ger) 6 F239
- Functioning 6 F239
- Functioning tests of detonators 6 F240
- Furan and derivs 6 F240–F241
- 5,5'-dinitro-2,2'-difuran 6 F241
- 2,5-dinitrofuran 6 F241
- furan peroxide 6 F241
- 1,2,3,4-furan-tetramercurous acetate 6 F241
- 2-nitrofuran 6 F240
- 1,2,3,4-tetraiodofuran 6 F240
- Furanols and derivs 6 F241–F241
- nitrofurans 6 F241–F242
- nitroso furans 6 F241
- Furfural and derivs 6 F242–F244
- furfural-N-nitriminoguanidine 6 F243
- furfuraloximes 6 F243
- furfuraloxime peroxide 6 F243
- 5-nitrofurfural-2 (& -3) 6 F242–F243
- 5-nitro-furfural-N-nitriminoguanidine 6 F243
- 5-nitro-furfuraloxime 6 F243
- 5-nitro-furfural semicarbazones 6 F243–F244
- Furfuryl 6 F244
- Furfuryl alcohol 6 F244–F245
- Furnaces and ovens 6 F244
- Furoamide and derivs 6 F245
- 2-nitro-2-furoamide 6 F245
- 5-nitro-N-nitro-N-methyl-2-furoamide 6 F245
- Furoic acid and derivs 6 F245–F246
- nitro furoic acids 6 F245–F246
- 5-nitro-nitrato ethyl-2-furoate 6 F246
- Furoyls 6 F246
- 2,2'-difuroyl peroxide 6 F246–F247
- 2-furoyl azide 6 F246
- 2-furoyl hydrazide 6 F246
- 2-furoyl hydroxamic acid 6 F246
- 2-furoyl nitrile 6 F246
- furoyl peracid 6 F246
- 5-nitro-2-furoylhydrazide 6 F246
- 5-nitro-2-furoyl hydroxamic acid 6 F246
- 5-nitro-2-furoyl nitrile 6 F247
- 5-nitro-2-(o-methyl)-furoyl hydroxamic acid 6 F246
- Furth (detonation) equation of state 4 D277
- Furyl 6 F247
- Furylacrylic acid and derivs 6 F247
- furyl- β -acrylic acid peroxide 6 F247
- furyl- β -(2,4,6-trinitro)-styrene 6 F247
- lead 5-nitro-furyl- β -acrylate 6 F247
- 5-nitro- β -furylacrylic acid 6 F247
- Fusain 3 C353; 6 F248
- Fused salts 6 F248
- Fusee 6 F248
- Fusee (Fr) 6 F248
- Fusees (Fr) 6 F248–F249
- Fusee-type flares 6 F64, F249
- Fusehead bead of Ingram 6 F250
- Fuseheads, electric characteristics of 6 F250
- Fusehead (electric matchhead) 6 F249–F250
- Fuseheads, pressures produced by their combustion 6 F250
- Fuse hot wire used in pyrotechnics 4 D762
- Fuse igniters or lighters used in ordnance items 4 D768–D769
- Fuse lighter "Pyrocore" 4 D763; 8 P500

- Fuse lighter "Pyrofuse" 4 D762; 8 P501
- Fuse lighters used in pyrotechnics 4 D762;
8 P512–P515
- Fuse lighter "Thermalite ignitacord" 4 D762
- Fuse, liquid-metal, self-healing 6 F250–F251
- Fusel oil 6 F251
- Fuse match lighter used in pyrotechnics 4 D762
- Fuses 6 F251–F252
- Fuses, Bickford 2 B112
- Fuses, Bickford cordeau 2 B112
- Fuses, detonating 6 F252
- Fuses, miner's 1 B112
- Fuses, safety 6 F252–F253
- Fuses described in the book of Fordham 6 F253
detonating fuse 6 F253
instantaneous fuse 6 F253
safety fuse 6 F253
- Fuse test 1 XXII–XXIII
- Fusible alloy 6 F253–F254
- Fusible metals 6 F254
- Fusil (Fr) 6 F254
- Fusinit(e) 6 F254
- Fusion 6 F254
- Fusion mixture 6 F254
- Fusion reaction 1 A500–A504
- Fusion reactor 6 F254
- Fuze catalog of 1970 6 F254
- Fuze detonator, definition of 4 D836–D837,
D840, D850
- Fuze detonators, description of instantaneous
4 D841–D850
- Fuze detonators, instantaneous electric 4 D846
- Fuze detonators, instantaneous flash 4 D841
- Fuze detonators, instantaneous stab 4 D844
- Fuze, flueric 6 F112
- Fuze, Ger 6 F254
- Fuze handbook, up-dated 6 F255
- Fuze items (detonators, primers and some
pyrotechnics) use of delays, relays and leads in
4 D856
- Fuze primers, description of instantaneous
4 D850–D856
- Fuze primers, gasless delay 4 D868
- Fuze primers, instantaneous electric 4 D854
- Fuze primers, instantaneous percussion 4 D852
- Fuze primers, instantaneous stab 4 D850
- Fuzes 4 D879–D933; 6 F255–F257
artillery 6 F255
bombs 6 F256
for demolition items 6 F256
for hand grenades 6 F256
for land mines 6 F256–F257
- Fuzes and fuze components, environmental and
performance tests for 6 F257–F258
- Fuzes for use in items other than artillery
ammunition 4 D925
- Fuzes, igniting 4 D879
- Fuzes, list of 4 D879
- Fuzes, physical testing 4 D1099–D1103,
D1103–D1107
- Fuze, sources for information 6 F259
- Fuze, spitback 6 F259
- Fuze train 6 F259
- FZG 6 F259

G

- "G" 6 G1
 "G" (pulver) see Cool propnlts 3 C511;
 Gallwitz 5 E116
 "G1" (pulver) 6 G1
 "G-117-b" (rocket powder) 6 G1
 GA (chemical warfare agent) 6 G1
 GA see Dimethylaminocyanophosphoric acid
 5 D1308–D1309
 Gabeaud, Louis 6 G1
 Gacon 6 G1
 Gadolin, A.W. 6 G1
 Gadolinium 6 G1–G2
 Gadolinium oxide 6 G2
 Gaens expl 6 G2
 "GAF" carbonyl iron powders 6 G2
 G-agent 2 C167–C168; 6 G2
 Gages 6 G2–G3
 Gages, diaphragm 6 G3
 Gages, optical spring 6 G3
 Gages, piezoelectric 3 C339–C345; 6 G3
 Gages, spring 6 G3
 Gages, strain 6 G4–G5
 Gain rifling or increasing twist of rifling 6 G6
 Gaine (sheath) 6 G6–G7
 Gaine-relais (Fr) 6 G7
 gal 6 G7
 d-Galactan and derivs 6 G7
 d-galactan trinitrate 6 G7
 d-Galactonamide and its pentanitrate
 1 A122–A123
 d-Galactonic acid and its pentanitrate see Aldonic
 acids 1 A122–A123
 d-Galactonic acid pentanitrate 1 A123
 d-Galactose and derivs 6 G8
 d-galactose pentanitrate 6 G8
 Galcit 6 G8
 Galena 6 G8
 Galeries d'essais see Coal mining expls 3 C371
 Galette (Fr) 6 G8
 Galex 6 G8–G9
 Galil rifle 6 G9
 Galil rifle 6 G9
 Gallacetophenone and derivs 6 G9
 gallacetophenone azide 6 G9
 Gallaher powder 6 G9
 Galleries for testing permissible (coal mining)
 expls 1 XIV; 3 C370–C378; 6 G9
 Gallery practice ammunition 6 G9
 Gallic acid 6 G9–G10
 Gallic powder 6 G10
 Gallium 6 G10
 Gallium triazide 1 A536
 Gallotannic acid 6 G10
 Galls 6 G10
 Gallwitz, Uto 3 C511; 6 G10
 Galvani, Luigi 6 G10
 Galvanic (voltaic) 6 G10
 Galvanism 6 G11
 Galvanize 6 G11
 Galvanograph 6 G11
 Galvanometer 6 G11
 Galvanometer chronograph 6 G11
 Galvanometric titration method 6 G11
 Gambir or gambier 6 G11
 Gamma (γ) cellulose 2 C96; 6 G11
 Gamma radiation 6 G11
 Gamma radiation effect on expls 6 G11–G12
 Gamma rays 6 G12
 Gamma rays, analysis 6 G12–G13

- Gamma-rays, behavior of proplnts under
6 G13; 9 R60–R66
- Gamma-TNT 6 G13; 9 T317
- Gamsits 3 C443; 6 G13
- Gap 6 G13
- Gap tests 1 XIV–XV; 4 D397–D399; 6 G13–G14
- Gap test of Spencer Chemical Co, Kansas City, Mo
1 A354; 6 G14
- Gap transmission of detonation through various
gases 6 G14
- GAR 6 G14
- Garand, John C. 6 G14
- Garand rifle 6 G14
- Garcia (explosivo) 6 G14
- Gargouse (Fr) 6 G14
- Garnier, Maurice 6 G14
- Garside, Buckley & Yates 6 G14
- Gas analysis or gasometric analysis 6 G15–G16
- Gas and gas laws 6 G15
- Gas, black see Carbon black 2 C55
- Gas, blast furnace 6 G16
- Gas, blau 6 G17
- Gas bubbles effect on detonation of expls 6 G17
- Gas cannon device 6 G17
- Gas cannons 6 G17
- Gas, carbon disulfide 2 C60–C61
- Gas, carbon monoxide 2 C62
- Gas, chemical warfare (CWG) 2 C171
- Gas chromatography and gas-liquid
chromatography 3 C293
- Gas cleaning and purification 6 G18
- Gas and coal dust expln 6 G18
- Gas, coal 6 G18
- Gas, coal mine or fire damp 6 G18
- Gas, coke-oven 6 G19
- Gas, combustible 6 G19
- Gas conditioning 6 G19
- Gas dispersion 6 G19–G20
- Gasdruckpatronenen (Ger) 6 G20
- Gas engines or internal combustion engines 6 G20
- Gaseous discharge lamps 6 G20
- Gaseous detonations and explns 4 D351–D360,
D360–D363; 6 G20–G21
- Gaseous metal treatment 6 G21
- Gaseous mines or fiery mines 6 G21
- Gases, detonation (and deflagration) in 4 D360
- Gases, detonation (and expln) in 4 D351–D360
- Gases, dusts and vapors, detonation (and expln) of
4 D360–D363
- Gases, fuel 6 G21
- Gases liberated from explns initiated by impact
6 G21
- Gases produced on decomposition of smokeless
proplnts 6 G21
- Gases produced on deflagration of smokeless
proplnts. Their nonideal behavior 6 G22
- Gases produced on expln or detonation of expls
6 G22–G23
- Gas-generating cartridges 2 C70–C72
- Gas-generating nondetonating compositions 6 G23
- Gas hydrates 6 G23–G24
- Gas ignition point 6 G24
- Gas, illuminating 6 G24
- Gasket materials used in ordnance 6 G24
- Gas, laughing 6 G24; see Nitrogen monoxide
8 N129
- Gasless delay detonators, electric 6 G24–G25
- Gasless delay elements and detonators employing
them 4 (section 4, part F) D863–D868
- Gasless delay fuze primers 4 D868–D869
- Gasless delay powders for ammunition fuze
applicators 6 G25

- Gasless expls investigated in Russia 6 G25–G26
- Gasless ignition powders 6 G26
- Gasless mixture 668/M 6 G26
- Gasless powders for delay elements of fuzes 6 G26
- Gasless reactions 6 G26–G27
- Gas liquor see Ammoniacal liquor 1 A305
- Gas munition 2 C165–C178; 6 G27
- Gas, natural 6 G27–G28
- Gas, noxious 6 G28
- Gas oil 6 G28
- Gasoline 6 G28–G29
- Gasoline, high octane number 6 G29
- Gasoline, polymer 6 G29
- Gasoline, reformed 6 G29
- Gasoline, straight 6 G29
- Gas, pintsch 6 G29
- Gas pockets in liquid and solid expls 6 G29–G30
- Gas, poisonous 2 C165–C171
- Gas pressure cartridges 6 G30
- Gas pressure developed on deflagration of proplnts
1 XX; 6 G30
- Gas pressure developed on expln or detonation
of expls 2 B180–B184, B214–B215;
3 C330–C345; 4 D483; 6 G30–G35
- Gas, producer and Mond gas 6 G35
- Gas pyrofax 6 G35
- Gas shells 6 G35–G36
- Gas, tar 3 C379–C380; 6 G36
- Gas testing apparatus suitable for detecting the
presence of expl or combustible gas in air
6 G36
- Gas, toxic 2 C165–C171
- Gas turbines 6 G36
- Gas volumes produced on expln or detonation
of expls 6 G36–G41
- Gas warfare agents 2 C165–C171
- Gas, water and carburated water gas 6 G41–G42
- Gathurst (poudre de) 6 G42
- Gathurst powder 6 G42
- Gathurst powder (sheathed) 3 C452
(bottom of table)
- Gatterman, Ludwig 6 G42
- Gatting machine gun (organgrinding machine
gun) 6 G42
- Gaubitz (Rus) 6 G42
- Gauss, Karl Friedrich 6 G42
- Gautier receiver 6 G42
- Gay-Lussac, Josef-Louis 6 G42
- Gay-Lussac acid 6 G43
- GDEE see Ethyleneglycol diethylether 6 E255
- GDI and GDM 6 G43
- GD^oMT 6 G43
- Geante (poudre) 6 G43
- Geiger-Muller counter or tube 6 G43
- Geissler, Heinrich 6 G43
- Gel or jel 6 G43
- Gels for flame throwers 6 G43
- Gelamites 6 G43
- Gelammonite no 1, antifrost 6 G43
- Gelatin and glue 6 G43–G44
- Gelatin (expl) 6 G44–G45
- Gelatin, 100% 6 G45
- Gelatina (Ital and Span) 6 G45
- Gelatina 808 (Ital) 6 G45
- Gelatina-Dinamite N.O. (Ital) 3 C440; 6 G45
- Gelatina esposiva (Ital or Span) 6 G45
- Gelatina explosiva al collodion 6 G45
- Gelatina explosiva al fulmicoton 6 G45
- Gelatina explosiva de guerra 6 G45
- Gelatina gomma 6 G45
- Gelatine (Fr) 6 G45

- Gelatine A, blasting (Brit) 6 G46
 Gelatine-Aldorfite 6 G46
 Gelatine a l'ammoniaque A ou n° 2 6 G46
 Gelatine-Astralit (Ger) 6 G46
 Gelatine B, blasting (Brit) 6 G46
 Gelatine, blasting 5 D1591
 Gelatin blasting expl 6 G46
 Gelatine-carbonit (Ger) 6 G46
 Gelatine-carbonite 6 G47
 Gelatine-Cheddit (Ger) 6 G47
 Gelatine-Cheddite (Swiss) 6 G47
 Gelatine-Dahmanit 6 G47
 Gelatin detonating expl containing chopped straw
 6 G47
 Gelatin diaspon 5 D1553
 Gelatine-Donarit (Ger) 6 G47
 Gelatin-Dynamite containing crystalline salts
 6 G49
 Gelatin Dynamite for blasting under high liquid
 pressure 6 G49
 Gelatin Dynamites (Amer) 5 D1600 (table V)
 Gelatine Dynamites 6 G48
 Gelatine-Dynamites (Fr) 6 G48
 Gelatines 6 G45
 Gelatines, Fr 5 D1591
 Gelatin-Dynamite (Jap) 3 C454
 Gelatin-Dynamite containing AN 6 G49
 Gelatin Dynamite containing AN (Jap) 6 G49
 Gelatin-Dynamites of Apache Powder Co, Benson,
 Ariz 5 D1602 (tables VI & VIII)
 Gelatin-Dynamite containing glycol ethers
 6 G49-G50
 Gelatin-Dynamites, low-freezing 5 D1592
 (table II)
 Gelatin-Dynamite containing oxazoline 6 G50
 Gelatin-Dynamite containing S-hollow pellet 6 G50
 Gelatin-Dynamite containing surface active agents
 6 G50
 Gelatin-Dynamite containing triethanolamine salt
 6 G50
 Gelatin-Dynamite containing water 6 G50-G51
 Gelatine-Dynamite with improved plasticity 6 G50
 Gelatin-Dynamites, straight and extra 6 G50
 Gelatine-Dynamits (Ger) 6 G48-G49
 Gelatine-Dynamits (Ger & Swiss) 5 D1601
 (table VI)
 Gelatin-gamsit (Swiss) 6 G51
 Gelatine-Leonit (Ger) 6 G51
 Gelatine-Penthrinits 6 G51-G52
 Gelatine-Prosperit 6 G52-G53
 Gelatine-Telsit (Swiss) 6 G53
 Gelatine-Tremonits (Ger) 6 G53
 Gelatines, Verge (Swiss & Ger) 6 G53-G54
 Gelatine-wetter-Astralit (Ger) 6 G54
 Gelatine-wetter-Nobelit (Ger) 6 G54
 Gelatinization accelerants 6 G54
 Gelatinization coefficient (Fr) 3 C389
 Gelatinization coefficient of Soler (G) 6 G54
 Gelatinization coefficient of NCs and coefficient
 de plasticite 6 G54
 Gelatinization rate for NC 6 G55
 Gelatinization of various NCs conducted at
 PicArsn before WWII 6 G55
 Gelatinized dinitrotoluene expls 6 G55
 Gelatinized Dynamites 5 D1599-D1602
 (tables IV, V, VI, VII & VIII)
 Gelatinized expls, Ger 5 D1599-D1602
 Gelatinized trinitrotoluene expls 6 G56
 Gelatinizers and stabilizers for smokeless propnlts
 6 G56
 Gelatinizing agents see Colloiding agents
 3 C398-C403

- Gelatinizing (or plasticizing) power of substances in expls or proplnts 6 G56
- Gelatinous Dynamites with expl base 5 D1599–D1602
- Gelatinous nitrate containing polyisobutylene-gelled naphthene base 6 G57
- Gelatinous permissible expl 6 G57
- Gelation 6 G57
- Gelatit 1 6 G57
- Gelbin see Calcium chromate 3 C279
- Gelbite of Emmens (Amer) see Emmenosite 5 E87
- Gelbpulver 6 G57
- “Gelex” 6 G57
- Gel for incendiary bombs 6 G59
- Gelgas see Flame throwers – liquids and gels 6 F56 ff
- Gelignite 6 G57–G58
- Gelignite a l’ammoniaque 6 G58
- Gelignite all’ ammonio (Ital) 3 C440
- Gelignite, ammon Dynamite 1 A368 (table)
- Gelignite d’arendonck 6 G59
- Gelignites (Belg) 6 G59
- Gelignites (Belg & Fr) 6 G59
- Gelignite (Ital) 3 C440
- Gel-lacquer application 6 G59
- Gelled gasoline 6 F56 ff
- Gelled high energy oxidizers 6 G59
- Gelled liquid nitroparaffins 6 G59
- Gelled proplnt safety investigation 6 G59–G60
- Gelling normally liquid hydrocarbons 6 G60
- Gelling point 6 G60
- “Gelobel” 6 G60
- Gelose 6 G60
- Gelosine 6 G60
- Geloxites 6 G60
- Gelsemine 6 G60
- Gelsemine, nitration 6 G61
dinitrogelsemine 6 G61
- Gemperle expl 6 G61
- General (detonation) equation of state 4 D277
- Generators, chemical and smoke producing 2 C165; 6 G61–G62
- Genetron 1132A 6 F126 ff
- Genie see Ding-dong 5 D1380
- Gentisic acid and derivs 6 G62
nitrogentisic acids 6 G62
- GEOM (Ital) 3 C439
- Geophone 6 G62
- Geophysical prospecting 6 E358–E359
- Ger ammunition 6 G63
- German big guns of WWI and WWII 2 B113–B114
- Ger bombs 6 G63
- Ger cannons 6 G63
- Ger carbines and rifles 6 G63
- Ger commercial expls (gewerblickesprengstoffe) of WWII 6 G63
- Ger deep bonding process 3 D37–D38
- Ger Dynamits and their substitutes 6 G63–G64
- Ger electric fuzes 6 G64
- Ger flares 6 G64
- German fragment test 3 C350
- Ger fuzes 6 G64
- Ger gelatine Dynamits 6 G64
- Ger “G” proplnt 5 D1536; 6 G64
- Ger granaten 6 G64
- Ger gudol proplnt 5 D1537–D1538
- Ger guidance system and guidance missiles 6 G64
- Ger guns and cannons 6 G64
- Ger gun proplnts of WWII 6 G64–G65
- Ger handgrenades 6 G65
- German HE bomb trains 2 B224
- Ger HDP supergun 6 G65

- Ger hollow charges (hohlladungen) or shaped charges 6 G65
- Ger igniters 6 G65
- Germanium, gadolinium and gold salts 6 G65
- Ger land mines 6 G65
- Ger long range guns 2 B113–B114; 6 G65
- Ger man salt 6 G65
- Ger markers 6 G65
- Ger message tube 6 G65
- Ger Metriol trinitrate 6 G65
- Ger military expls of WWII 6 G65–G66
- Ger military expls of WWII used as fillers in anticoncrete and armor-piercing shells 6 G66
- Ger military powders 6 G66
- Ger mine expl of WWI 6 G66
- Ger minenhund 6 G66
- Ger muzzle charging device 6 G66
- Ger Myrol and its expls 6 G66
- Ger natter Ba 349A & Ba 349B guided missiles 6 G66
- German naval expls and weapons of WWI & WWII 6 G67
- Ger nipolit proplnts 6 G67
- Ger nonpermissible expls 3 C438
- Ger observing bullet 6 G67
- Ger panzer 6 G67
- Ger panzerfaust and panzergranate 6 G67
- Ger panzerschreck and panzerwurfmine 6 G67
- Ger permissible expls 3 C451
- Ger photoflash bomb and photoflash composition 6 G67
- Ger pistols of WWII 6 G67
- Ger pistol grenades 6 G67
- Ger primary compositions and primers 6 G67
- Ger propagandarakete 6 G67
- Ger proplnts 6 G67
- Ger proplnt igniters 6 G68
- Ger proximity fuze 6 G68
- Ger pupchen 6 G68
- Ger pyrotechnic antipathfinder devices 6 G68
- Ger pyrotechnics 6 G68
- Ger R-4M rocket 6 G68
- Ger recoilless gun 6 G68
- Ger rheinbote 6 G68
- Ger rheintochter 6 G68
- Ger rifle 6 G68
- Ger rifle discharger 6 G68
- Ger rifled projectile 6 G68
- Ger rifle grenades 6 G68
- Ger rochling projectile 6 G68
- Ger rocket 6 G68
- Ger rocket-assisted shell 6 G68
- Ger rocket launchers 6 G68
- Ger rocket proplnts of WWII 6 G68–G69
- Ger rodded bomb or stick grenade 6 G69
- Ger R-salt and its expls 6 G69
- Ger sabot projectile 6 G69
- Ger sarin see German trilons and GB 2 C167
- Ger Sanger-Bredt supersonic missile 6 G69
- Ger schnorkel 6 G69
- Ger sea dog 6 G69
- Ger Sebastopol gun 6 G69
- Ger self-destroying fuze, tracer bullet and tracer shell 6 G69
- Ger shrapnel projectiles 6 G69
- Ger signal device 6 G69
- Ger-sinoyd priming mixture 6 G69
- Ger small arms ammunition 6 G69
- Ger smoke and chem rocket 6 G69
- Ger smoke bomb 6 G69

- Ger smoke generator 6 G69
- Ger smoke hand grenade 6 G69
- Ger smoke projectile 6 G69
- Ger soman see GD 2 C168; German trilons 6 G72
- Ger sound gun 6 G69
- Ger spigot mortar projectile 6 G70
- Ger spike bomb 6 G70
- Ger spotting projectile 6 G70
- Ger sprengbrandbombe 6 G70
- Ger 132° stability test 6 G70
- Ger 135° stability test 6 G70—G71
- Ger star shell 6 G71
- Ger steel and iron ammunition items 6 G71
- Ger substitute expls of WWII see Ersatzsprengstoffe 5 E121—E122
- Ger supergun see German HDP supergun 6 G65
- Ger tabun see German trilons . . . 2 C167
- Ger taifun rocket 6 G71
- Ger tapered bore gun 6 G71
- Ger tapered bore projectile or gerlich projectile 6 G71
- Ger tanks 6 G71
- Ger tellermine 6 G71
- German test, 132° 1 XV
- Ger tetan (TeNMe) or X-stoff and its expls 6 G71
- Ger "Thor" and "Karl" mortars 6 G71
- Ger torpedoes, mines and depth bombs of WWI and WWII 6 G71
- Ger totalites 6 G71
- Ger tracer compositions and tracers 6 G71
- Ger tracer projectiles 6 G72
- Ger trilons 6 G72
- Ger T-stuff (T-stoff) 6 G72
- Ger U-boat-21 6 G72
- Ger U-boat, one man 6 G72
- Ger U-boat Walter 6 G72
- Ger V-1 6 G72
- Ger V-2 6 G72
- Ger vocabulary of ordnance 6 G72
- Ger warplants, arsenals, research centers and proving grounds 6 G72
- Ger weapons of WWI and WWII 6 G72
- Ger (West) weapons 6 G72
- Ger wettersprengstoffe 6 G72
- Ger wind gun 6 G72
- Ger wind tunnel 6 G72
- Ger X-4 guided missile 6 G72
- Ger X-stuff 6 G72
- Ger Z-salt (z-salz) 6 G72
- Ger Z-stuff C and N 6 G72
- Gerresdorfer and bals powders 6 G73
- Geserick of Rotterdam 6 G73
- Gesilits 6 G73
- Gesteinssprengstoffe 6 G73
- Gheksamony 6 G73
- Gheksoghen (Russ) 6 G73
- Ghinijonet 6 G73
- Giant coal mine powder and giant low flame powder 6 G73
- Giant powder 6 G73—G74
- Giedyuim powder 6 G74
- GI expl 6 G74
- Gilded metal 6 G74
- Giles flask and its applications 6 G74—G76
the analysis of commercial mixed acids
6 G74—G76
- Gilles 6 G76
- Gilsonite or uintaite 6 G76
- Girard, Aime 6 G76
- Girard, Charles 6 G76—G77
- Girard, Millot & Vogt 6 G77

- Giua, Michele, Dr 6 G77
- Glacial acetic acid 1 A25; 6 G77
- Glaser 6 G77
- Glass and glass-blowing 6 G77–G78
- Glass in priming compositions 6 G78
- Glass bulbs for weighing acids 6 G78–G79
use in the analysis of oleums 6 G78–G79
- Glass cleaning and solvents used 6 G79–G80
- Glass Dynamite 6 G80
- Glass-feather manometer 6 G80
- Glass temperature 6 G80
- Glamber, Johann Rudolph 6 G80
- Glazing or graphiting of proplnts 6 G80
- Glide bombing 5 D1523; 6 G81
- Gliding torpedo GT-1 6 G81
- Gliosiline or Abelite 1 A2; 6 G81
- Glmite 6 G81
- Globular proplnt powder 6 G81
- Glonoin 6 G81
- Glossary of ordnance and other terms used in a
description of ordnance items 4 D742
- Gloves, conductive 6 G81
- GLTN 6 G81
- Glucinum see Beryllium 2 B107
- d-Gluconamide pentantrate 1 A123
- D-Glucitol (sorbitol) and derivs 6 G81–G82
D-glucitol hexantrate 6 G82
D-glucitol nitrate 6 G82
- Gluckauf 6 G82
- d- α -Glucoheptose 6 G82
d- α -glucoheptose hexantrate 6 G82
- d-Gluconamide and its pentantrate 6 G82
- d-Gluconic acid and its pentantrate 6 G82–G83
- Glucopyranose and derivs 6 G83
 α -(or β -) D-glucopyranose pentantrate 6 G83
- Glucosan and derivs 6 G83
 β -glucosan-2,3,4-trinitrate or levoglucosan-
2,3,4-trinitrate 6 G83
- Glucose and derivs 6 G83–G84
d-glucose pentantrate or nitroglucose
6 G83–G84
- Glucose for preparation of sorbitol 6 G84
- Glucose-glycerol and lactode-glycerol nitrates
6 G84
- Glucosides and glycosides 6 G84
- Glucoside nitrate in mixture of nitrated
polyethyleneglycol 6 G84
- Glucosides, nitration studies 6 G84
 α -methyl-d-glucopyranoside tetrantrate 6 G84
- Glue-gelatines 6 G85
- Glue, nitrated 6 G85
- Glues 6 G43–G44, G84–G85
animal glue 6 G84–G85
vegetable glue 6 G85
- Glues used for military purposes 6 G85
- Glug & slug—units of mass 6 G85
- Glukodine 6 G85–G86
- Glutaric acid and derivs 6 G86
glutaric acid diazide 6 G86
- Glutaricacidglycine and derivs 6 G86
azidoglutaricacidglycine azide 6 G86
- Glutazine and derivs 6 G86
dinitroglutazine 6 G86
nitroglutazine 6 G86
- Gluten 6 G86
- Glutol see Formaldehyde-starch mixtures 6 G86
- Glyceraldehyde 6 G86–G87
- Glyceride 6 G87
- Glycerin(e) 6 G87
- Glycero 6 G87
- Glycerogen 6 G87
- Glycerol or glycerin and derivs 6 G87–G93
glycerol analysis 6 G88–G92
glycerol analysis, tests for NG 6 G92–G93

- Glycerol acetates 1 A31–A33
- Glycerol acetate dinitrate 1 A33; 6 G93
- Glycerol- α,α' -bis-[2,4-dinitrophenylether]
6 G93–G94
- Glycerol chlorohydrin and its nitrated derivs
3 C265; 6 G94
- Glycerol diacetate and its nitrates 1 A33
- Glycerol dichlorohydrin and its nitrated derivs
5 D1211; 6 G94
- Glycerol- α,γ -diethylether- β -nitrate 6 G94
- Glycerol dinitrate 6 G94
- Glycerol- α -[2,4-dinitrophenylether] and deriv
6 G94
glycerol- α -[2,4-dinitrophenylether] dinitrate
(Dinitryl) 6 G94
- Glycerol- α,α' -dipicrylether- β -nitrate 6 G94
- Glycerol ethers, nitrates of 6 G94–G95
, diethyl 6 G94–G96
, dimethyl 6 G94
- Glycerol formal 6 G95
- Glycerol formate dinitrate 6 F173
- Glycerol-glycol-ether trinitrate 6 G95
- Glycerol- α,α' -hexanitrodiphenylether- β -nitrate
6 G95
- Glycerol methylether dinitrate 6 G95
- Glycerol monoacetate and its dinitrate 1 A33
- Glycerol monoacyl derivs 6 G95
- Glycerol- α -monoamine see Amino-2,3-propanediol
1 A251
- Glycerol- β -monoamine see 2-Amino-2,4-propane-
diol 1 A251
- Glycerol monochlorohydrin dinitrate
3 C265–C266; 6 G96
- Glycerol monoglycolate trinitrate 6 G96
- Glycerol monolactate trinitrate 6 G96
- Glycerol- α -monomethylether dinitrate 6 G96–G97
- Glycerol monostearate, alpha 6 G97
- Glycerol nitrates and derivs 6 G97–G98
commercial glycerol dinitrate 6 G97–G98
1,3-dinitratoglycerol 6 G97
glycerol acid dinitrate 6 G98
 α,β -glycerol dinitrate 6 G97
- Glycerolpentaerythritol ether pentanitate
6 G108
- Glycerol-peroxide expl 6 G108
- Glycerol substitutes 6 G108
- Glycerol-sugar nitrates 6 G108–G109
- Glycerol Trinitrate or Nitroglycerin (NG)
5 D1593–D1594; 6 G98–G108
additional physical properties of NG 6 G98
batch manufacture of NG 6 G100–G101
chemical properties of NG 6 G99
continuous manufacture of NG 3 C501–C504
desensitization of NG 3 D88–D90
expl properties 6 G99
Glycerol Trinitrate, analytical procedures
6 G103–G104
history of NG 6 G99–G100
military specification for NG for use in proplnts
6 G104–G106
NG, tests not required by military specification
MIL-N-246B 6 G106–G108
toxicity of NG 6 G102
uses of NG 6 G102–G103
- Glycerol trinitrite 6 G108
- Glycerol- α -[2,4,6-trinitrophenylether] dinitrate
6 G109–G110
- Glycerol tripermanganate 6 G110
- Glycerol-tris (trinitrobutyrate) 6 G110
- Glyceronitre 6 G110
- Glyceropyroxyline 3 C327; 6 G110
- Glyceryl (radical) 6 G110
- Glyceryl triacetate see Triacetin 1 A31
- Glycide 6 G110
- Glycide nitrate 6 G110–G111
- Glycine see Aminoacetic acid 1 A178
- Glycine nitrate see Aminoacetic acid nitrate
1 A178
- Glycine, nitro see Nitroaminoacetic acid 1 A178

- Glycinonitrile, N-(4,6-diamino-s-triazin-2-yl)
6 G111
- Glycocoll see Aminoacetic acid 1 A178
- Glycocyanine 6 G111
- Glycol butylether acetate 6 E254
- Glycol condensation products 6 E254
- Glycol dinitrate see Ethyleneglycol dinitrate
6 E259
- Glycol dinitrate-nitroisobutylglycol dinitrate
mixtures see Ethyleneglycol dinitrate-nitro-
isobutyl dinitrate mixtures 6 E278
- Glycol dinitrate polymers see Ethyleneglycol
dinitrate polymers 6 E278
- Glycol dinitrophenylether nitrate see Ethylene-
glycolphenylether and derivs 6 E279
- Glycoldiphenylether see Bis (phenyl)-ethylene-
glycolether 2 B153
- Glycol-di-trinitrobutyrate (GTNB) see Ethylene-
glycol-di-trinitrobutyrate (EGTNB) 6 E255
- Glycol esters and ethers see Ethyleneglycol and
derivs 6 E247 ff
- Glycolglycolate dinitrate see Ethyleneglycol-
glycolate dinitrate 6 E256
- Glycol, higher 6 G115
- Glycolic acid and derivs 6 G115
glycolic acid azide 6 G115
- Glycolic acid, methylester and derivs 6 G115
glycolic acid, methylester nitrate 6 G115
- Glycolide, 2,5-dioxo-1,4-dioxane 6 G116
- Glycolmethylene ether see 1,3-Dioxalane
5 D1405–D1406
- Glycol, monoethers 6 G116
- Glycol, monophenylether of see Ethyleneglycol
phenylether 6 E279
- Glycolonitrile and derivs 6 G116
glycolonitrile nitrate 6 G116
- Glycolphenylether, phenyl "cellosolve" see
Ethyleneglycol phenylether 6 E279
- Glycol polymers or polyglycols see Ethylene-
glycol polymers, nitrated 6 E279
- Glycols and derivs 6 G111–G114
, analysis and test methods 6 G114
, listing of glycols 6 G112
, chemical properties 6 G112–G113
, list of glycols 6 G112
, physical properties of glycols 6 G112
, toxicity 6 G113
, uses 6 G113–G114
- Glycol, tertiary ethers of 6 G116
- Glycol trinitrophenylether nitrate see Ethylene-
glycol phenylether and derivs 6 E279
- Glycolurethane and derivs 6 G116–G117
N-nitroglycolurethane nitrate 6 G117
- Glycoluril see Acetylenediurein and derivs
1 A65; 6 G117–G118
dinitroglycolurils 6 G117
tetranitroglycoluril 6 G117–G118
- Glycolyl 6 G118
- Glycolylurea and derivs see Hydantoin and derivs
7 H188
- Glycosin see Bunudazole and derivs 2 B115
- Glycuril and derivs same as Acetylenediurein
1 A65–A66
- Glycyamidine 6 G111
- Glykol (Ger) 6 G118
- Glyoxal 6 G118
- Glyoxaline and derivs see 1,3-Diazole and derivs
5 D1165–D1166
- Glyoxiline 6 G118–G119
- Glyoxime and derivs 6 G119
nitroblyoxime 6 G119
- GM-1 6 G119
- Gmelin, L. 6 G119
- Gnom 6 G119
- "Gob" fires in coal mines 6 G119
- Goddard, Robert H. 6 G119–G120
- GOER vehicles 6 G120
- Goetz powder 6 G120
- Gold acylide 1 A76
- Gold azide 1 A536

- Golem see Dormant missile 5 D1535
- Golovine expl 6 G120
- Gomez 6 G120
- Gomme 6 G120
- Gonflement, coefficient de (Fr) 3 C389
- Gonne 6 G120–G121
- Gooch, Frank Austin 6 G121
- Goodyear powder 6 G121
- “Goop” 6 G121
- Goriunov, P.M. 6 G121
- Gossot, Fernand 6 G121
- Gotham expl (Amer) 6 G121
- Goudron (Fr) 6 G121
- Government book store 6 G121–G122
 defense documentation center (DDC) 6 G121
 national technical information service (NTIS)
 6 G121
 US govt printing office (GPO) 6 G121
- GP see General purpose bombs 4 D935
- GPF (Fr) 6 G122
- “G” pulver (Ger) 3 C511–C512; 5 D1536–D1537;
 6 G122
- Grabe, Carl 6 G122
- Grade construction 6 G122
- Grageroff, I.A., Dr 6 G122
- Graham, Thomas 6 G122
- Graham expl 6 G122
- Grain 6 G122–G123
- Grain dust explns see Dust explns 5 D1578
- Graining 1 A314; 3 C564; 6 G123
- Graining of smokeless proplnts 6 G123
- Grains of smokeless proplnts 6 G123–G124
- Grakrult 6 G124
- Granada, fabrica de polvoras y explosivos de
 6 G124
- Granata (Russ) 6 G124
- Granate (Ger) 6 G124
- Granadfullung (Ger) 6 G124
- Granatfullung (Ger) 6 G124
- Granatfullung 02 or Fp 02 (Ger) 6 G124
- Granatprobe (Ger) 6 G124
- Grandcamp expln 6 G124
- Granodizing process 6 G124
- Granular expls of whetstone 6 G125
- Granular smokeless proplnts 6 G125
- Granulation of an expl or proplnt 6 G125
- Granulation process 6 G125
 by briquetting 6 G125
 by dissolving a solid material in a liquid and
 running the solution in a thin stream into
 another liquid 6 G125
 by fusion 6 G125
 by melting of a solid material 6 G125
 by Olsen process 6 G125
 by spray drying 6 G125
 by the Cabot spheronizing process 6 G125
 with a binding agent 6 G125
- Granulation test 1 XV
- Granulite 6 G125–G126
- Granulometry of expls 6 G126
- Grape-shot or case-shot 6 G126
- Grape sugar 5 D1116
- Graphic methods 6 G126
- Graphigen rocket fuel 6 G126
- Graphite 6 G126–G127 see also Carbon
 2 C54–C56
- Graphite, colloidal 6 G127
- Graphite-containing rocket proplnts 6 G127
- Graphite, dry (for use in ammunition, military
 specification MIL-G-155A of 20 Sept 1962/
 13 July 1967) 6 G127–G130
- Graphite, pyrolytic or pyrographite 6 G131
- Graphitic oxide 6 G131–G132
- Graphite oxide by expln 6 G132

- Graphitic oxide expl 6 G132
- Graphiting of smokeless proplnts 6 G132
- Grave, I.P. 6 G133
- Gravimetric analysis, inorganic 6 G132
- Gravimetric analysis, organic 6 G132
- Gravimetric density see Density 3 D66
- Gravimetric density of a proplnt 6 G132–G133
- Graydon expl 6 G133
- Greaves and Hahn expls 6 G133
- GrBIP (Ger) 6 G133
- Greek fire 6 G133
- Green cross (Ger) 6 G133
- Greener (poudre) 6 G133
- Greener, William 6 G133–G134
- Greenhill, Sir George 6 G134
- Green powder see French anarchists expl
6 F190, G134
- Gregorini's expl 6 G134
- Gremuchaya rtut'ili ful'minat rtuti (Russ) 6 G134
- Gremuchii studen' (Russ) 6 G134
- Grenade (Fr) 6 G134
- Grenade launcher 6 G139–G140
- Grenades 1 A384 see Grenades 6 G134–G139
, history of 6 G134–G136
, listing of present types of 6 G135–G138
, types of US 6 G138–G139
- Grenades, hand and rifle 4 D829; 6 G134–G139
- Grenades, special topics and testing 6 G140–G141
- Grenadine 6 G141
- Grenadine 6 G141
- Grenage (Fr) 6 G141
- Grenee poudre 6 G141
- Grenite (Amer) 6 G141
- Gribeauval, Jean-Baptiste de 6 G141
- Gricellite-couche 6 G141
- Griess, Peter 6 G141
- Griffing's expls 6 G141–G142
- Grignard, Victor 6 G142
- Grignard's reaction and reagent 6 G142
- Grignon 6 G142
- Grille de pointage (Fr) 6 G142
- Grinding 3 C564
- Grinding mills 3 C565–C566
- Grisou (Fr) 6 G142
- Grisou-Dynamites (Fr) 6 G142
- Grisou-naphthalites (Fr) 6 G142–G143
- Grisounines 6 G143
- Grisounites 6 G143
- Grisoutina C; Grisoutina al 10% and Grisoutina
al 13.20% 3 C451
- Grisoutines 6 G143–G144
- Grisoutites (Belg) 6 G144
- Grist 6 G144
- Grisunaftalita 3 C455
- Grisutin (Russ) 6 G144
- Grisutita capa see Spanish permissible expls
3 C455
- Grit 6 G144
- Grit influence on initiation of expls by impact and
friction 6 G144
- Groggins, Philip H. 6 G145
- Grommets 6 G145
- Gromoboy (Russ) 6 G145
- Groove diameter 6 G145
- Grottanelli stability test 6 G145
- Ground coke 6 G145
- Grounding against lightning in expls and
ammunition plants 6 G146
- Ground signal proplnt 6 G146
- Growth of expln in electrically initiated RDX
6 G146

Grune 6 G146

Greisen (detonation) equation of state 4 D278, D289 and D290

Gruneisen function, effective 6 G146

GSX see 1,7-Dichloro-2,4,6-trinitro-2,4,6-tri-
azaheptane 5 D1215

GTNB see Ethyleneglycol-dinitrobutyrate 6 E255

Gu 6 G146

Guaiacol and derivs 6 G146–G148

dinitroguaiacols 6 G147

mononitroguaiacols 6 G147

trinitroguaiacols 6 G147–G148

Guanazine 1 A209–A210

Guanazole see 3,5-Diamino-asym-triazole
5 D1148; 6 G148

Guanazol 6 G148

Guanidine and derivs 6 G148–G169

N,N'-bis (guanyl)-N,N-diaminoethylenediamine
dihydrazoate 6 G168

N,N'-bis (guanyl)-trimethylenediamine 6 G168

N^{2,6}-diguanidinomelamine dihydrochloride
6 G167

1,4-dihydro-2-amino-4,4-dimethyl-6-guanidino-
s-triazine dinitrate 6 G168

1,4-dihydro-2,6-bis (guanidino)-1-guanyl-4-
guanylimino-s-triazine-trihydrochloride
6 G168

1-(1,1-dimethyl)-2-nitroxyethyl)-3-nitro-
guanidine 6 G165

, analytical procedures and tests 6 G153–G154

, other guanidine and guanyl derivs 6 G165

guanidine carbonate 6 G149

guanidine chlorate 6 G149–G150

guanidine chromates 6 G150

guanidinefluorochromate 6 G150

guanidine hydrochloride 6 G150

guanidine nitrate 6 G150

guanidine nitroform 6 G151–G152

guanidine oxalate 6 G152

guanidine perchlorate 6 G152

guanidine picrate 6 G152–G153

guanidine sulfate 6 G153

guanidine tetraperoxoniobate 6 G153

guanidine thiocyanate 6 G153

guanidinium-3,5-bis (nitramino)-as-triazole
see Diaminotriazoles 5 D1149

Guanidine and derivs (cont'd)

guanidinium dinitrocyanomethylide 6 G166

guanidinium-1,1-dinitroethylide 6 G166

guanidinium-5-dinitromethyltetrazolide 6 G167

guanidinium-3,5-dinitro-as-4H-triazolide 6 G167

guanidinium fulminuride 6 G167

guanidinium hydrazine decaborohydride 6 G167

guanidinium hydrazinium dihydrazide 6 G167

guanidinium hydrazoate 6 G167

guanidinium-5-nitraminotetrazolide 1 A260

guanidinium-5-(3-nitro-1-guanidino) tetrazolide
6 G167

guanidinium-3,5,7-trinitrotropolonate 6 G167

guanidinoformylazide hydrochloride 6 G168

N²-guanidinomelamine dihydrochloride 6 G168

guanyl azide derivs and salts see Azido-
formamidine 6 F168–F169

guanylguanidine see Biguanide 2 B114

guanylhydrazine see Aminoguanidine 1 A210

guanylmelamine 5 D1147–D1148

1-methyleamino-3-nitroguanidine 6 G165

nitroguanidine 6 G154–G158

nitroguanidine and derivs analytical procedures
6 G160–G161

nitroguanidine expls 6 G158–G159

nitroguanidine nitrate 6 G159

nitroguanidine perchlorate and diperchlorate
6 G159

nitroguanidine, requirements and tests of
6 G161–G164

nitroguanidine silver salt 6 G160

nitrosoguanidine 6 G164–G165

1-nitro-3-(2,2,2-trifluoroethyl)-guanidine
6 G165

nonafluorodiaminomethyl guanidine 6 G165

octafluoroaminomethyl guanidine 6 G165

pentafluoroguanidine 6 G165–G166

tetrachloroiodoguanidine 6 G166

α -tetrazol-5-yl-guanidine 6 G166

α -tetrazol-5-yl-guanidine nitrate 6 G166

2,2,2-trifluoroethylguanidine nitrate 6 G166

2,2,2-trifluoroethylguanidine picrate 6 G166

2,4,6-triguanidino-s-triazine 6 G168

Guanylnitrosaminoguanyl tetrazene (Tetracene)
6 G169–G172

, military specification 6 G171–G172

, preparation 6 G169–G171

, properties 6 G170

, salts 6 G172

, uses 6 G170

- Guanylpentafluorodiaminomethane **6 G172**
- Guanylurea and derivs **5 D1217**
- Guar gum **6 G173**
- Gudolpulver (Ger) **5 D1537–D1538; 6 E116, G173**
- Gudron (Russ) **6 G173**
- Guerrilla incendiary mixture **6 G173**
- Guerrilla warfare **6 G173–G174**
- Guggenheim process **6 G174**
- Guhrdynamit or Dynamit no 1 **5 D1588–D1589, D1595–D1596; 6 G174**
- Guhr, kieselguhr, diatomite, diatomaceous earth **6 G174**
- Guhrhellhoffit **6 G174**
- Guichard's balance method for detn of stability **6 G174–G175**
- Guidance system of a missile **6 G175–G178**
 , acoustic homing devices **6 G175**
 , ballistic guidance system or inertial-gravitation **6 G176**
 , infrared **6 G176**
 , magnetic ballistic guidance system **6 G176**
 , radar guidance system **6 G176**
 , radio controlled guidance systems **6 G176–G178**
- Guided aircraft missile (GAM) **6 G178**
- Guided aircraft rocket (GAR) **6 G178**
- Guided bomb **6 G178**
- Guided missiles **1 A384; 6 G178–G180**
- Guided missile, antitank **6 G180**
- Guided missiles, Ger of WWII **6 G181–G183**
- Guided missile, Ger V-2 **6 G184**
- Guided missile launcher **2 C29; 6 G185**
- Gum **6 G186**
- Gum arabic or acaciagum **6 G186**
- Gum, dragon **6 G186**
- Gum green **6 G186**
- Gum kauri **6 G186**
- Gum incendiaries **6 G187**
- Gum lac **6 G187**
- Gummidynamit **6 G187**
- Gum-resins **6 G187**
- Gum sandarac **6 G187**
- Gum-sugar **6 G187**
- Gum-tree **6 G187**
- GuN **6 G187**
- Gun **2 C26–C27; 6 G187–G190**
- Gun ammunition components **6 G190**
- Gun and guided weapon **6 G192**
- Gun, atomic **6 G190**
- Gun-barrel corrosion inhibitor **6 G190–G191**
- Gun breech **6 G191**
- Gun carriage **6 G191**
- Guncotton see Cellulose nitrate **2 C106–C108; 6 G191**
- Guncotton compressed **6 G191**
- Guncotton Dynamite **6 G192**
- Gun flash **6 G192**
- Gun gases in combat aircraft **6 G192**
- Gun life factor (GLF) (Brit) **6 G192**
- Gun liquid proplnt of Detroit Controls Corp **6 G192**
- Gun mantlet **6 G192**
- Gunmetal (bronze) **6 G192**
- Gunnery **6 G192–G193**
- Gunn's expl (Amer) **6 G193**
- Gun pendulum test **1 VII–VIII; 6 G193**
- Gun perforator **6 G193**
- Gun-plow **6 G193**
- Gunpowder, black **2 B165–B175; 6 G193**
- Gunpowder, brown **2 B173; see Cannon proplnt 2 C30**
- Gunpowder, initiation and thermal decompn of **6 G193**

G15

Gunpowder, white 6 G193

Gurney Constant and Gurney Formulas 6 G195

Guttman, Oscar 6 G196

Guttman's test 6 G196

Gutzeit, Heinrich W. 6 G196

Guyton de Morveau, Louis-Bernard 6 G196

Gymnastication 6 G196

Gypsum 6 G196

Gyro 6 G196

Gyroscope 6 G196

Gyroscopic action 6 G197

Gyroscopic movement of projectiles 6 G197

H

- H₂ 7 H1
- H₂ same as N-Acetylamidomethylenetetramine-mononitrate 1 A54
- H2 Kongo or type 98 expl 7 H1
- H-4 7 H1
- H-5 7 H1
- H-6 expl 7 H1
HBX 7 H1
- H-16 7 H1
- H-16 same as 2-(4)-Acetyl-1,9-diacetoxy-4(2)-6,8-trinitro-2,4,6,8-tetrazanonane 1 A57
- H-19 7 H1
- H21 or MSX 7 H1
- Haber, Fritz 7 H1–H2
- Hackh & McLeod expl 7 H2
- Haensson-bakayoku or type 88 expl 7 H2
- Haeussermann, Carl 7 H2
- Hafenegger powder 7 H2
- Hafthohlladung 7 H2–H3
panzerhandmine 3 7 H3
- Haftmine 7 H3
- Hahn's expl 7 H3–H4
- Haid, August 7 H4
- Haid, Becker and Dittmar stability test 7 H4
- Haishokuyaku 7 H4
- Hake effect 7 H4
- Halokite 7 H4
- Hale, G.C. 7 H4–H5
- Haleite see Ethylenedinitramine 6 E238–E243
- HALEITE see N,N'-Dinitrodiaminoethane 5 D1137–D1138
- Halford-Kistiakowsky-Wilson equation of state 4 D278, D608 (equations 23 & 24)
- Hall (or Will) powder 7 H5
- Hall (John) & sons 7 H5
- Halobiphenyl derivs 7 H5
2-chloro-4', 5-dinitrobiphenyl 7 H5
2-halo-3, 5-dinitrobiphenyl 7 H5
- Haloclastite or haloklastit 7 H5
- Halogenated acetylenes 7 H5–H6
acetylene bromide 7 H5
acetylene chloride 7 H5–H6
bromo-1-methylacetylene 7 H6
dibromoacetylene 7 H6
dichloroacetylene 7 H6
diiodoacetylene 7 H6
iodoacetylene 7 H6
- Halogenated amides or amines 7 H6–H7
s-diacetyleneethylenedibromodiamine 7 H7
s-dibenzenesulfonylethylenedibromodiamine 7 H7
s-dibenzenesulfonylethylenedichlorodiamine 7 H7
N,N-dichloroformamide 7 H6
dibenzoyltrimethylenedichlorodiamine 7 H7
di-m-nitrobenzenesulfonylethylenedichlorodiamine 7 H7
s-di-m-(or p-) nitrobenzoylethylenedichlorodiamine 7 H7
s-diphenylacetyleneethylenedibromodiamine 7 H7
s-dipropionylethylenedibromodiamine 7 H7
s-dipropionylethylenedichlorodiamine 7 H7
di-s-toluenesulfonylethylenedibromodiamine 7 H7
N,N-ethylchloroformamide 7 H6
ethylenetetra-bromodiamine 7 H7
ethylenetetra-chloraminodiamine 7 H7
- Halogenated derivs of sulfonamides 7 H7–H9
arylsulfonalkylamides 7 H8
N-halogen derivs of p-halogen substituted benzenesulfonamides 7 H8–H9
sulfonalkylchloramides and sulfondichloramides 7 H7
- Halogenation 7 H9
- Halogen azides 7 H9
- Halogen-metal interconversions with halogenated anilines 7 H9
- Halotetrazole salts 7 H9
- 1-Halo-2-vinylacetylenes 7 H9–H10
1-chloro-2-vinylacetylene 7 H10

- 1-Halo-2-vinylacetylenes (cont'd)
 1-bromo-2-vinylacetylene 7 H10
 1-iodo-2-vinylacetylene 7 H10
- Haloxyline 7 H10
- Halsey and Savage expls 7 H10
- Halstead arsenal 7 H10
- Halved cartridge gap method see Physical tests
 1 XIV
- Hamilton 7 H10
- Hancock's expl 7 H10
- Handhabungssichere sprengstoffe (Ger) 7 H10
- Handgrenade 7 H10
- Handling bombs see Bombs 2 B238
- Handling expls 7 H11
- Handy-andy riot-control cartridge see E24
 (cartridge) 5 E1
- Hangfire 7 H12
- Hangfire primers 7 H12
- Hangfire test 7 H12
- Hannan expls 7 H12
- Hansen or hydrogen ion concentration stability
 test 7 H12–H13
- Hansen-Metz potentiometric test at 110° 7 H13
- Hardingham 7 H13
- Hardy's powders 7 H13
- Hargreaves theory of aging of blasting gelatins see
 Aging of Dynamites 1 A110
- Harle 7 H13
- Harpax or harpago see Catapult 2 C91
- Harpoon antiship missile (US Navy) 7 H13–H14
- Harrisite see Comp C-4 3 C485
- Harrison powders 7 H14
- Hart powder 7 H14
- Harry Diamond labs 7 H14
- Harvey's expl 7 H14
- Hasethrol 7 H14
- Hassia-chlorat or spreng-chlorat 7 H14
- HAST 7 H14
- Haswelite 7 H14
- Haubitze (Ger) 7 H14
- Hawk 7 H14
- Hawkins 7 H14
- Hawkins brothers 7 H14
- Hawkite 7 H14
- Hay 7 H14
 nitrohay (Fr) 7 H14–H15
- Haylite 7 H15
- Hazardous materials see Dangerous materials 3 D6
- Hazardous materials regulations, index 7 H15
- Hazards of detonations (and explns) 3 D5
- Hazards-prevention of industrial gas explns 7 H23
- HBX 7 H23–H24
- HBX-1, HBX-3 and H-6 expl compns 7 H25–H35
 US military specification MIL-E-22267A
 (31 May 1963) 7 H25–H35
- HBX-1 analytic procedure 7 H35
- HBX-3 analytical procedure 7 H35
- H-6 analytical procedure 7 H35
- HC mixture 7 H35
- HE 7 H35
- Headaches arising from contact with NG or
 Dynamites 7 H35–H36
- Health hazards of expls and proplnts 7 H36
- HEAT 7 H36
- Heat capacity 7 H37
- Heat conductivity, specific or coefficient of
 thermal conductivity 7 H37
- Heat content or enthalpy 7 H37
- Heat (definitions and selected refs) 7 H36
- Heat effects — data for common expls 7 H38

- Heat effects — examples of the use of heat data for estimating heat effects in expls and explns 7 H38—H46
- heat balance in estimating critical dimensions for thermal expln 7 H39—H40
 - heat conductivity coefficients and specific heats of common expls (table) 7 H45—H46
 - heat of decomposition 7 H39—H40
 - heat of detonation 7 H39
 - heat of nitration 7 H38
 - melting points, heats of fusion, heat of vaporization and heats of sublimation of common HE (table) 7 H44
 - standard heats of formation and heats of detonation of common expls (table) 7 H41—H42
 - standard heat of formation and heats of detonation of expl mixtures (table) 7 H43
- Heat effects — methods for estimating ΔH°_f 7 H47—H58
- estimation of heats of formation of organic chemical expls by group additivity 7 H47—H51
 - heats of formation of nitroalkanes 7 H53—H57
 - heats of formation of solid nitroaromatics 7 H51—H53
- Heat evolution (or liberation) in expls 7 H58
- Heath and Frost 7 H59
- Heat, latent 7 H58
- , of fusion 7 H58
 - , of vaporization 7 H58
- Heat, molecular 7 H59
- Heat of adsorption 7 H36—H37
- Heat of combustion see Detonation (and expln), deflagration (and combustion) and formation, heats of 4 D369—D370
- Heats of combustion, explosion and formation (tests) 1 IX; see Calorimeter, calorimetry and calorimetric determinations 2 C10—C12; Thermochemistry 9 T190—T204
- Heat of condensation 7 H37
- Heat of crystallization 7 H37
- Heat of decomposition 7 H37
- Heat of deflagration see Detonation (expln, deflagration, combustion and formation) heats of 4 D374
- Heat of detonation 4 D370—D375
- Heat of dilution 7 H37
- Heat of dissociation 7 H37
- Heat of dissolution or of solution 7 H38
- Heat of explosion 4 D375
- Heat of formation see Detonation (and expln), deflagration (and combustion), and formation, heats of 4 D374
- Heat of hydration 7 H58
- Heat of solution 7 H59
- Heat of sublimation 7 H59
- Heat of swelling 7 H59
- Heat of transition 7 H59
- Heat pulse 4 H348—H349; 7 H59
- Heat sensitization of expls and memory effect see Detonation, heat sensitization and memory effect in 4 D367
- Heat tests 1 XV—XVI; 7 H59
- 100° heat test 1 XV
 - 120° and 134.5° heat test 1 XV—XVI
- Heat value 7 H59
- Hebler powder or Wellite 7 H59
- Hecla powder 7 H60
- Hedgehog 7 H60
- HEI 7 H60
- HEIT 7 H60
- Hellhoff expl 7 H60
- Hellhoffit 7 H60
- Hemicelluloses (or semicelluloses) 7 H60
- Hemispherical iron-dish test 1 XXII—XXIII; 6 F31
- HEMP 4 D152
- Hemp fiber 7 H61
- Hemp hurds 7 H61
- Hemp nitrate 7 H61

- Hengstit 7 H61
- Henrite 7 H61
- HEO see Diethyloloxamide 5 D1243
- HEP 7 H61
- Heptane and derivs 7 H61–H63
 azidoheptanes 7 H62
 1,7-diazidoheptane 7 H62
 2,6-dichloro-2,4,6-trinitroheptane 7 H63
 dinitroheptanes 7 H63
 heptanedinitrile 7 H62
 heptanedioic acid, 4,4-dinitro 7 H63
 hexanitroheptanes 7 H63
 4-nitroso-4-nitroheptane 7 H62
 2,2,4,6,6-pentanitroheptane 7 H63
 trinitroheptanes 7 H62–H63
- N,2,2,2',2',2'-Heptanitrodiethylamine (BTNEN or HOX) 5 D1224
- Heptanoic acid and derivs 7 H63–H64
 4,6,6-trinitroheptanoic acid methyl ester 7 H63–H64
- Heptanone and derivs 7 H64
 1,1,1,7,7,7-hexanitro-4-hepanone 7 H64
- Heptryl see 2-Anilino-2-hydroxymethyl-1,3-dihydroxypropane 1 A441; 7 III (addendum)
- Heracline 7 H64
- Heraklin (Ger) 7 H64
- Hercoblastings 7 H64–H65
- Hercules Inc (product lines and plant locations) 7 H65–H71
- Hercules powder 7 H71–H72
- Herculite 7 H72
- Herculine 7 H72
- HERO 7 H72
- Hertz theory of impact 7 H72
- Herz, E. von 7 H72
- Herz's expls 7 H72
 bis [dinitro-hydroxy-azo-quinone] 7 H72
 dinitro-dihydroxy-azo-quinone 7 H72
 dinitro-hydroxy-azo-quinone 7 H72
 mono- (and di-) nitrohydroxy-azo-quinones 7 H72
- HES 4138 7 H72
- HE shell 7 H72
- Hesilit 7 H72
- Hess, P. 7 H73
 Hess' crusher test (Hess' brisance meter) 3 C492
 Hess' deflagration test 7 H73
 Hess test 7 H73
- Hess brisance test 1 VII–IX; 2 B299–B300
- HET 7 H73
- Heterocyclic compounds 7 H73
- Heuschrecke (Ger) 7 H73
- HEX 7 H73–H74
- Hexa, hexamin, hexamit, hexyl, or hexanitro-diphenylamine (HNDPhH) 5 D1434; 7 H74
- Hexa S-22, S-26, and E4 (Ger) 5 E122 (table E15)
- Hexachlorethane 7 H74
- Hexachloronaphthalene 7 H74
- 2,4-Hexadiyne-1,6-dihydroperoxide see Diacetylenic dihydroperoxides 5 D1120–D1121
- Hexaethylenetetramine 7 H74–H75
- Hexahydrobenzene see Cyclohexane and derivs 3 C595
- Hexahydrocatechol see Cyclohexanediol and derivs 3 C595–C596
- Hexahydro-1,3-dinitro-5-nitroso-5-triazine (NOX) 7 H75
- Hexahydro-3,6-dinitro-1,3,6-oxadiazepine 7 H75
- Hexahydro-1,3-dinitro-1,3,5-triazine nitrate (PCX) 7 H75
- Hexahydro-1-(methoxymethyl)-3,5-dinitro-s-triazine 7 H75
- Hexahydro-1-methyl-3,5-dinitro-s-triazine 7 H76
- Hexahydromethyl-s-triazatriborine 7 H76
- Hexahydro-2-oxo-1,3-dinitropyrimidene 7 H76
- Hexahydrophenol see Cyclohexanol and derivs 3 C596–C597
- Hexahydropyrogallol see Cyclohexanetriol and derivs 3 C496

- Hexahydroterephthalic acid diazide 7 H76
- Hexahydro-2,4,6-triimino-s-triazine 1 A216
- Hexahydro-3,5,7-trinitro-1,3,5,7-tetrazocine-1 (2H)-methanolacetate 7 H76–H77
- Hexahydro-1,3,5-trinitro-1,3,5 (1H)-triazepine 7 H77
- Hexahydro-3,5-trinitro-1,3,5-triazine see Cyclo-trimethylenetrinitramine 3 C611
- Hexahydro-1,3,5-trinitroso-1,3,5-triazine see Cyclo-trimethylenetrinitrosamine 3 C630
- Hexahydroxylamine cobalt nitrate 7 H77
- Hexakis (2,2,2-trinitroethyl)-melamine 7 H77
- Hexal 7 H77
- 3,3,7,7,11,11-hexamethanol-1,5,9-trioxacyclodecanehexanitate 7 H77
- 2,3,5,2',4',5'-Hexamethylazobenzene-6-azide 7 H77
- Hexamethyldiphenylmethane and derivs 7 H78
hexanitrohexamethyldiphenylmethane 7 H78
- 3,3,6,6,9,9-Hexamethyl-1,2,4,5-1,2,4,5-tetroxonane see 2,5-Bis (hydroperoxy)-2,5-dimethylhexene 2 B144
- Hexamethylenediamine and derivs 7 H78–H79
hexamethylenediaminedinitrate 7 H78–H79
hexamethylenediamine peroxide 7 H79
- Hexamethylenetetramine and derivs (HMTA) 7 H79–H83
hexamethylenetetramine-chromium tetroxide 7 H80
hexamethylenetetramine-dichromic acid 7 H80
hexamethylenetetramine dinitrate (HDN) 7 H81
hexamethylenetetramine expls 7 H80–H81
hexamethylenetetramine mononitrate 7 H81
hexamethylenetetramine nitroform salt 7 H81–H82
hexamethylenetetramine perchlorates 7 H82
hexamethylenetetramine peroxides 7 H82
hexamethylenetetramine-tetrachromic acid 7 H80
hexamethylenetetramino-tetrazido-copper 7 H83
- Hexamethylenetetramine and derivs (cont'd)
hexamethylenetetramine-trinitro-m-cresylate 7 H83
hexamethylenetetramine triperoxide 7 H83
hexamethylenetetramine styphnate 7 H82
- Hexamethylenetriperoxidediamine (HMTD) 5 D1375; 7 H83–H84
- Hexamethylolbenzene and derivs 7 H85
hexamethylolbenzene hexanitate 7 H85
- Hexamine 7 H85
- Hexamite [Hexanite, NTD₂ (Amer), Schiesswolle 8, TSMV 1-101 (Ger) Otsu B or Type A (Jap)] 7 H85
- Hexamines see Ammines or ammoniates 1 A275–A286; 7 H85–H86
- Hexamine, calcium 7 H86
- Hexamine chromic perchlorate 7 H86
- Hexaminecobalt (III) nitrate 1 A280; 7 H86
- Hexammons see Gheksamony 6 H73
- Hexane and derivs 7 H87–H88
azidohexanes 7 H87
dinitrohexanes 7 H87
nitrohexanes 7 H87
tetranitrohexanes 7 H87–H88
- Hexanediol and derivs 7 H88–H89
dinitrohexanediols 7 H88
2,5-hexanedioldinitrate 7 H88
2,5-hexanedioldinitrite 7 H88
2,3,4,5-hexanetetronetetroxime diperoxide 7 H88–H89
tetranitrohexanediols 7 H88
- Hexanetriol and derivs 7 H89
1,2,6-hexanetrioltrinitrate (HTTN) 7 H89
- Hexanhexol see Dulcitol and derivs 5 D1567
- Hexanites 7 H89
- Hexanitate dulcitol see Dulcitol hexanitate 5 D1567
- Hexanitroacetyldiphenylamine 1 A58
- Hexanitroanilinoxylenes 1 A443
- Hexanitroazobenzene see Azobenzene 1 A649
- Hexanitrobenzylaniline 2 B94

- 2,4,6,2',4',6'-Hexanitrobibenzyl 2 B111
- Hexanitrobiphenol 2 B122
- 2,4,6,2',4',6'-Hexanitrobiphenyl 2 B124
- Hexanitrobiphenyldicarboxylic acid 2 B126
- 2,4,6,2',4',6'-Hexanitrobiphenyl salts 2 B124
- Hexanitrobiresorcinol 2 B127
- 2,4,6,2',4',6'-Hexanitro-3,3'-bitolyl 2 B163
- Hexanitrobutane 2 B368
- Hexanitrocarbanilide or sym-dipicrylurea see
N,N'-Bis(2,4,6-trinitrophenyl)-urea 2 B156
- 2,4,6,2',4',6'-Hexanitro-3,3'-diaminobiphenyl
5 D1133–D1134
- N,N'-3,5,3',5'-Hexanitro-N,N'-diethylbenzidine
5 D1229
- Hexanitrodihydroxyazobenzene 5 D1269
- 3,5,3',5',N,N'-Hexanitro-N,N'-diisobutylbenzidine
5 D1196
- N,N'-3,5,3',5'-Hexanitro-N,N'-diisopropylbenzidine
5 D1496
- 1,1,1,1',1',1'-Hexanitro-di-isopropyl-urea
5 D1501
- Hexanitrodimethoxy-bis(phenylmercapto)-benzene
5 D1303
- 1,1,1,4,4,4-Hexanitro-2,3-methoxybutanediol
2 B370
- Hexanitrodimethylacetylene 5 D1305
- Hexanitro-N,N'-dimethylbenzidine 5 D1326
- N,N'-4,4',6,6'-Hexanitro-N,N'-dimethylbenzidine
5 D1326
- N,N'-4,4',6,6'-Hexanitro-N,N'-dimethyl-3,3'-diphenyldiamine
5 D1336
- Hexanitro- β,β' -dinaphthylamine 5 D1379
- Hexanitrodiphenylamine see Diphenylamine
5 D1434
- 2,4,6,2',4',6'-Hexanitrodiphenylamine, analytical
procedures 5 D1438–D1439
- Hexanitrodiphenylamine, salts of
5 D1439–D1440
- β -(Hexanitrodiphenylamino) ethyl nitrate
5 D1442
- 2,4,6,2',4',6'-Hexanitrodiphenyldianthranilide
5 D1448
- Hexanitrodiphenyldisulfide 5 D1450–D1451
- Hexanitrodiphenylethers 5 D1453–D1454
- Hexanitrodiphenylethylene (HNS)
5 D1457–D1458
- 2,4,6,2',4',6'-Hexanitrodiphenylmethylamine
5 D1468
- 2,4,6,2',4',6'-Hexanitrodiphenyloxamide
5 D1470
- Hexanitro-N,N'-diphenylphenylenediamine
5 D1471
- 2,4,6,2',4',6'-Hexanitrodiphenylpropylenediamine
(Methylene Ditetryl) see Bis(anilino)-propane
and derivs 2 B132–B133
- 2,4,6,2',4',6'-Hexanitrodiphenylselenide
5 D1476
- Hexanitrodiphenylsulfide see Diphenylsulfide
5 D1477
- Hexanitrodiphenylsulfone see Diphenylsulfone
5 D1480
- Hexanitrodiphenyloxide see Hexanitrodiphenyl-
ether 5 D1453
- 2,4,6,2',4',6'-(Hexanitrodiphenyl)-ethylene-
dinitramine (Bitetryl, Ditetryl or Octyl) see
1,2-Bis(2',4',6'-trinitronitranilino)-ethane
2 B131
- Hexanitrodiphenyl guanidine see N,N'-Bis
(2,4,6-trinitrophenyl)-guanidine 2 B154
- 2,4,6,2',4',6'-Hexanitrodiphenylmethylamine see
Diphenylmethylamine 5 D1468
- N,N'-Hexanitrodiphenylpropane-1,3-dinitramine
(Methylene Ditetryl) see 1,3-Bis(2',4',6'-
trinitro-N-nitranilino)-propane 2 B133
- N,N'-(Hexanitrodiphenyl)-propylene-1,3-di-
nitramine (Methylene Ditetryl) see 1,3-Bis
(2',4',6'-trinitro-N-nitranilino)-propane
2 B133
- N,2',2',3,3,3-Hexanitrodipropylamine 5 D1494

- N,N'-3,5,3',5'-Hexanitro-N,N-dipropylbenzidine
5 D1495
- 3,3,3',3',3'-Hexanitro-N,N'-n-dipropylurea
5 D1501
- Hexanitrodioresorcin see Hexanitrobioresorcinol
2 B127
- Hexanitrodioresorcinol see Bis-resorcinol and
derivs 2 B127
- Hexanitro o, m, or p-ditolylamines 5 D1515
- Hexanitro-ditolyl-sulfide 5 D1518—F1519
- Hexanitrodulcite 5 D1567
- Hexanitroethane 5 E149
- Hexanitroethylcarbonate 6 E219
- Hexanitrohydrazobenzene or N,N'-dipicryl-
hydrazine 5 D1463
- 2,4,6,2',4',6'-Hexanitro-N-methyl-diphenylamine
1 A440
- Hexanitromethylphenylether 7 H90
- 3,3,5,5,7,7-Hexanitro-1,9-nonane diisocyanate
7 H90
- Hexanitrophenolanthrone see 10,10-Bis(4-
hydroxyphenyl)-x,x,x,x,x-hexanitro-9-
anthrone 2 B147; 7 H90
- 3,3,3,3',3',3'-Hexanitropropylsulfone 5 D1501
- Hexanitrosobenzene 2 B45
- Hexanitrosulfobenzide see Hexanitrodiphenyl-
sulfone 5 D1480
- 2,4,6,2',4',6'-Hexanitroxylamine 5 D1527
- Hexanols and derivs 7 H90—H91
dinitrohexanols 7 H90—H91
- Hexanones and derivs 7 H91
dinitrohexanones 7 H91
- Hexazadienes 7 H91
- Hexazidocuprate-lithium salt 7 H91
- Hexazidostannate-sodium salt 7 H91
- Hexazobenzene see Diazidobenzene 2 B42
- Hexenes and derivs 7 H92—H93
5,5 (or 3,4)-dinitro-2 (or 3)-hexene
7 H92—H93
- Hexenes and derivs (cont'd)
1,1,1,6,6,6-hexanitro-3-hexene 7 H93
nitro-hexenes 7 H92—H93
- Hexit 5 D1434
- Hexite see Hexanitrodiphenylamine 5 D1434
- Hexo (Ger) see Cyclonite 3 C611 ff
- Hexo (S-15 and S-22) (Ger) 5 E122 (table E15)
- Hexocire (Fr) 7 H93
- Hexogen (Ger) see Cyclotrimethylene trinitramine
3 C611 ff; 7 H93
- Hexolit 7 H93
- Hexolites (Fr) 7 H93
- Hexone T4 see RDX 3 C611 ff
- Hexonite (Swiss) 7 H93
- Hexonyl see Hexanitrodiphenylamine 5 D1434
- Hexoplast 75 7 H93—H94
- Hexotol 7 H94
- Hexotonal 7 H94
- HEXYL see Hexanitrodiphenylamine 1 A215
- Hexylamines see Aminohexanes 1 A215
- Hexylene ozonide 7 H94
- Hexylnitrate 7 H95
- Hexylnitrite 7 H95
- 3-Hexyne and derivs 7 H95
1,1,1,6,6,6-hexanitro-3-hexyne 7 H95
- Heyrovsky, Jaroslav 7 H95
- Hidrolitas 7 H95
- High and low temperature tests for small arms
ammunition 7 H101
- High-blast expl filler 7 H95
- High-blast metal oxygen expls 7 H95—H96
- High capacity (HC) bombs 7 H96
- High density expls 7 H96
- High energy fuels see Exotic fuels 6 E350
- High expls (HE) 7 H96
- High expl projectile (shell) 7 H96—H97

- High expls, contrasting patterns in the behavior of
4 D190
- High expls, detection as π complexes
7 H97–H100
- High expls, detonics of 7 H100
- High-expl train 4 D838–D839
- High grade NC see Cellulose and derivs 2 C108
- High-low pressure gun (H/L gun) 7 H101
- High and low temperature tests for small arms
ammunition 7 H101
- High mechanical strength expls 7 H101
- High nitrogen content compounds as flash
reducing agents 7 H101–H102
- High panel test 3 C350
- High pressure effect on expls 7 H102–H103
- High-pressure technique 7 H103–H104
- High-pressure test (HPT) cartridge see Cartridge,
ammunition 2 C74
- High rate detonator production study 7 H104
- High speed optical devices used for measuring
detonation rates 1 X; see Experimental deter-
mination of detonation velocity
5 D632–D640
- High speed photography 7 H104–H112
 - , color photography 7 H110
 - , electronic amplification of light images and
techniques of image enhancement
7 H106–H107
 - , expl light sources 7 H109–H110
 - , flash lamp light sources 7 H109
 - , flash X-rays 7 H106
 - , high-speed & very high speed cameras
7 H104–H105
 - , high-speed video systems 7 H105
 - , illumination for high-speed photography
7 H109
 - , image dissection cameras 7 H106
 - , introduction 7 H104
 - , laser light 7 H110
 - , photographic films and processing procedures
7 H110
 - , ultra high-speed cameras 7 H105–H106
- High-speed radiography 1 XVI
- High velocity test gun 7 H112–H113
- Highways and byways in combustion 7 H113
- Hill powder 7 H113
- Himalaya's expls (Portugal) 7 H113
- Himley expls 7 H113
- Hinde expl 7 H113
- Hinshelwood, Sir Cyril 7 H113
- Hippuric acid and derivs 7 H113–H114
 - 3,5-dinitrohippuric acid 7 H114
 - hippuric acid azide 7 H113
 - mononitrohippuric acids 7 H113
 - mononitrohippuric acid azide 7 H113–H114
 - 4-nitrohippuryl-aminoacetyl azide 7 H114
- Hirschfelder & Roseweare (detonation) equation
of state 4 D278
- Hirschfelder-Sherman calcn of thermochemical
constants for proplnts 7 H114
- Hirschfelder-Stevenson-Eyring (detonation)
equation of state 4 D278
- Hispano-Suiza gun 7 H114
- Historical summary on AN 1 A312–A313
- History and properties of Ammonals
1 A287–A288
- History of expls, ammunition and weapons
7 H114–H161
 - , chronological listing of inventions and
events 7 H116–H159
 - , introduction 7 H114–H115
 - history of incendiaries, fireworks and Blk
Powder up to the middle of 19th century
7 H115–H116
- History of NG 6 G99–G100
- "Hive of bees" 7 H161–H162
- HMSO 7 H162
- HMX see Cyclotetramethylenetetramine
3 C605–C610; 7 H162
- HNO 7 H162
- HNDPhS see 2,4,6,2',4',6'-Hexanitrodiphenyl-
sulfide 5 D1477–D1478
- HNDPhSo see 2,4,6,2',4',6'-Hexanitrodiphenyl-
sulfone 5 D1480

- HNS see Diphenylethylenhexanitro 5 D1456
- Hoch-und niederdruckkanone (Ger) 7 H162–H163
- Hochdruckpumpe (HDP) oder V-3 7 H163
- Hochexplosivkorper (Ger) 7 H163
- Hochstatter powder 7 H163
- Hohlladung (Ger) 7 H163
- Hoitsema's stability test 7 H164
- Hoko (Ger) 7 H164
- Hollings 7 H164, H166
- Hollow charge efficiency test 1 XXIII
- Hollow charge nose attachment for AP bombs
7 H166
- Holmgrens 7 H166
- Holocellulose 7 H166
- Holtex 3 C396–C397; C402–C403; 7 H166
- Holzmine 42 (Ger) 7 H166
- Homing guidance system 7 H166–H167
- Homocyclonite see HMX 3 C605 ff
- Homogenization and homogenizers 7 H167
- Honest John 7 H167
- Honey 7 H168
nitrohoney 7 H168
- Hop record of a gun carriage or mount 7 H168
- Ho-pao 7 H168
- Hope 7 H168
- Hopkinson's pressure test bar 1 XVI
- Horn-Seifert stability test 7 H168
- Hornet ball cartridge see Cartridge, ammunition
2 C74
- Horns 7 H168
- Horse detonator 7 H168
- Horsedung expl 7 H168
- Horsley Dynamites 7 H168
- Hot bar test of high and low expls 7 H168–H169
- Hot extrusion of shells 7 H169
- Hot spots 7 H170–H175
 , a novel mechanism 7 H174–H175
 , a novel method for estimating hot spot
 temperatures 7 H174
 , generation mechanisms 7 H170
 , heat flow from 7 H172–H173
 , hydrodynamic 7 H173–H174
 , introduction 7 H170
 , theoretical development 7 H170–H172
 , use of high energy radiation to create
 7 H175
- Howard powder 7 H175
- Howden Dynamite 7 H175
- Howittite 7 H175
- Howitzer 2 C27
- HOX see Diethylamine and derivs
5 D1224–D1225
- HS see Mustard gas 2 C168
- Hs (Henschel) missiles (Ger) 7 H175–H176
 Hs 293, Hs 298, Hs 298-V-2 7 H176
- HSC see Cordite 3 C535
- HTA 7 H176
- HTA-3 7 H176
- HTA-3, analytical procedures 7 H176
- HTA-3, US military specification requirements
 and tests 7 H176–H178
- Hubner powder 7 H178
- Hudson expl 7 H178
- Hudson Maxim expl 7 H178
- Huff-duff (HFDF) 7 H178
- Hugoniots 7 H179–H185
- Hugoniot and Rankine-Hugoniot (detonation)
 equation of state 4 D278
- Huile de Nobel (Fr) 7 H185
- Huile detonante, ou Huile expl 7 H185
- Hull 7 H185
- Hulls, nitrated 7 H185
- Humidification and humidity 7 H185–H187
- Humidity equilibrium method (hygry) 7 H252

- Humidity test see Hygroscopicity test 1 XVI;
7 H251–H254
- Hummel (Ger) 7 H187
- Humus 7 H187
- Hungarian ammunition, expls and weapons
7 H187
- Hurst 7 H187
- Hybalines 7 H187
- Hybrid rocket proplnts 7 H187–H188
- Hydantoin and derivs 7 H188
N-nitrohydantoin 7 H188
- Hydral-cellulose 7 H188
- Hydra programs 7 H188–H189
- Hydrated cellulose 7 H189
- Hydrated expls 7 H189
- Hydraulic coal bursters 7 H189
- Hydrazide 7 H189
- Hydrazides 7 H190
- Hydrazidicarboxylic acid, methyl ester 7 H190
- Hydrazidioxalic acid-diazaide 7 H190
- Hydrazinate of diammoniododecaborane 7 H190
- Hydrazine 7 H190–H194
, analytical 7 H192
, chemistry 7 H192
, expl and combustion properties
7 H192–H193
, expl compns 7 H193
, prepn 7 H190–H191
, toxicology 7 H191
, uses 7 H191–H192
- Hydrazine and derivs, analytical procedures
7 H204–H206
- Hydrazine azide 7 H194
- Hydrazine azide hemi-ammonate 1 A537
- Hydrazine azide monohydrazinate 1 A537
- Hydrazine chlorate 7 H194–H195
- Hydrazine chloride 7 H195
- Hydrazine chlorite 7 H195
- Hydrazine dichloride 7 H195
- Hydrazine hydrate 7 H195–H196
- Hydrazine hydrate and hydrazine reactions with
expl violence 7 H196
- Hydrazine hydrosulfate 7 H196
- Hydrazine nitrates 7 H196–H200
hydrazine dinitrate 7 H198–H199
hydrazine mononitrate 7 H196–H198
hydrazine nitrate complexes 7 H199–H200
- Hydrazine nitrite 7 H196
- Hydrazine perchlorate 7 H200–H201
- Hydrazine perchlorate and chlorate complexes
7 H201–H202
- Hydrazine, reactions with metals and their salts
7 H202
- Hydrazine salts of organic acids 7 H202–H203
- Hydrazine substituted aryl derivs 7 H204
- Hydrazine substituted derivs 7 H203–H204
monomethylhydrazine 7 H203
unsymmetrical dimethylhydrazine (UDMH)
7 H203–H204
- Hydrazine sulfate 7 H204
- 3-Hydrazine-1,2,4-triazole 7 H210–H211
- Hydrazinobenzene and derivs 7 H207–H208
hydrazinobenzene reactions 7 H207–H208
hydrazino compounds, analytical procedures
7 H208
hydrazinodinitrobenzene 7 H207
hydrazinomononitrobenzene 7 H207
hydrazinotrinitrobenzene 7 H207
N-nitroso-N-[2,4-dinitrophenyl]-hydrazine
7 H207
- Hydrazinodicarbonic acid and derivs 7 H208
hydrazinodicarbonic acid diazide 7 H208
- Hydrazinoethane see Ethyl hydrazine 6 E300
- Hydrazinoethane; 2,2-dinitro see 2,2-Dinitro-
ethyl hydrazine 6 E300
- Hydrazinohydroxyazobenzene and derivs 7 H208
4,6-dinitro-3'-hydrazino-4-hydroxyazobenzene
7 H208
- Hydrazinomethane 7 H209

- Hydrazinophenol and derivs 7 H209
4,6-dinitro-3-hydrazinophenol 7 H209
- Hydrazinopyridine and derivs 7 H209
nitrohydrazinopyridine 7 H209
- 5-Hydrazino-tetrazole 7 H209–H210
- Hydrazinotoluene and derivs 7 H210
dinitrohydrazinotoluenes 7 H210
mononitrohydrazinotoluene 7 H210
2,4,6-trinitro-3-hydrazinotoluene 7 H210
- Hydrazobenzene and derivs see N,N'-Diphenyl-
hydrazine and derivs 5 D1426–D1463; 7 H211
trinitrohydrazobenzenes 7 H211
- Hydrazobisformamidine see Biguanidine 2 B115
- 5,5'-Hydrazo-bis-1H-tetrazole see Bis (5-
tetrazole)-hydrazine 2 B157; 7 B211
- Hydrazoic acid see Azides 1 A537–A542
- 5,5'-Hydrazotetrazole 7 H211
- Hydrazulmin 7 H211
- Hydrides see Al-hydride 1 A145; B-hydrides
2 B253–B256; 7 H211–H212
- Hydrin 7 H212
- Hydrinwestfalite 7 H212
- Hydrobel 7 H212
- Hydrocarbon 7 H212
- Hydrocarbons 7 H212–H213
- Hydrocarbons as rocket fuels or expls 7 H214
- Hydrocellulose 7 H213
, nitrate 7 H213
- Hydrocinnamic acid and derivs 7 H213–H214
 α -azidohydrocinnamic acid 7 H213
ibid azide 7 H214
- Hydrocyanic acid 7 H214
- Hydrodynamics 7 H214–H215
- Hydrodynamic detonation velocity 4 D630
- Hydrodynamic theories of detonation 4 D610
- Hydrofluosilicic acid see Fluosilicic acid 6 F141
- Hydrogen 7 H215–H216
- Hydrogen bomb see Atomic bomb 1 A499
- Hydrogen azide and hydrozoic acid
1 A537–A542
hydrogen azide, anhydr 1 A538–A539
hydrogen azide, aq 1 A539–A540
- Hydrogen bond 7 H216
- Hydrogen bonding conception gelatinization
of NC 7 H216
- Hydrogen chloride, anhydr and hydrochloric acid
7 H216–H217
- Hydrogen fluoride, anhydr and hydrofluoric acid
7 H217
- Hydrogen gun 7 H217
- Hydrogen-ion concn (pH) 7 H217–H218
- Hydrogenite 7 H218
- Hydrogen peroxide (T-stuff) 7 H218–H222
, additional info (Ger mfg and WWII uses)
7 H221–H222
, analytical 7 H219
, chemistry 7 H219
, expl and combustion properties
7 H219–H220
, expls 7 H220
, in propnt 7 H220
, preparation 7 H218–H219
- Hydrogen selenide 7 H222
- Hydrogen sulfide 7 H222
- Hydrogen telluride 7 H222
- Hydrogen tetraoxide 7 H222
- Hydrolysis 7 H222–H223
- Hydrolysis of plasticizers for NC by water
at 22° and 60° 7 H223
- Hydrolysis test for NC's 7 H223–H224
- Hydrolytic reaction 7 H224
- Hydrometer 7 H224
- Hydronitric acid see Azoimide 1 A537
- Hydronitrogens 7 H224
, saturated 7 H224
, unsaturated 7 H224
- Hydronitrous acid 7 H224
- Hydronium ion 7 H224

- Hydroperoxides, organic 7 H224–H227;
8 P200–P202 (table 6), 8 P205–P209
- Hydroquinone and derivs see 1,4-Dihydroxy-
benzene 5 D1270; 7 H227–H228
azidoquinone 7 H228
diazidodinitrohydroquinone 7 H228
dinitrohydroquinone 7 H228
nitrohydroquinone 7 H228
trinitrohydroquinonedithylether 7 H228
- Hydrosilicofluoric acid see Fluorosilicic acid
6 F141
- Hydrosol 7 H228
- Hydrostatic fuze 4 D881
- Hydrostatics 7 H228
- Hydrous 7 H227
- Hydrox 7 H228–H229
- Hydrox fuel cell see Fuel cells 6 F210
- Hydroxides, inorganic 7 H229–H230
- Hydroxy 7 H230
- Hydroxyacetanilide and derivs 1 A20–A21; 6 G115
2-hydroxy-3,4,6-trinitroacetanilide 1 A21
hydroxyacetazide see Glycolic acid azide
6 G115
- Hydroxyacetophenone and derivs 7 H230
hydroxyacetophenone azide 7 H230
hydroxy-trinitro-acetophenone 7 H230
- Hydroxylalkyl alkylene dinitramines and their
nitrate esters 7 H230
- Hydroxyamines 1 A179
- Hydroxyaminoanthraquinones and derivs see
Aminohydroxyanthraquinone and derivs 1 A217
tetranitrohydroxyaminoanthraquinone 7 A217
- Hydroxyaminobenzene see Aminophenol
1 A242–A244
isopicramic acid 1 A243
picramic acid 1 A241
- Hydroxyaminobenzoic acid see Aminosalicylic
acid 1 A257
- 1-Hydroxy-6-aminobenzotriazole 7 H231
- Hydroxyaminobutane see Aminobutanol 1 A192
- Hydroxy and amino compounds, expls from
7 H231
- Hydroxyaminomethylbenzene see Aminocresol
1 A193
- Hydroxyaminomethylpropane 1 A233
- Hydroxyaminopropane see Aminopropanol
1 A253
- Hydroxy- and amino-methylnitramines 7 H231
- Hydroxyanilinobenzene-diazonium see Anilino-
benzene-diazonium hydroxide 1 A421
- Hydroxyanilinopropane see Anilinopropanol
1 A436
- Hydroxyanthraquinone and derivs 7 H231
1-hydroxy-4,5,8-trinitroanthraquinone 7 H231
- Hydroxyazapropane nitroxynitro deriv see NENA
1 A210
- 1-Hydroxy-III-azidoiminomethyltriazine 7 H232
- Hydroxyazobenzene and derivs 7 H232–H233
dinitrohydroxyazobenzene 7 H233
mononitrohydroxyazobenzene 7 H232–H233
trinitrohydroxyazobenzene 7 H233
- 5-Hydroxy-1,5'-azotetrazole 7 H233
- Hydroxybenzaldehyde and derivs 7 H233–H234
4,6-dinitro-3-hydroxybenzaldehyde
7 H233–H234
2,4,6,2',4',6'-hexanitro-3,3'-dihydroxybenza-
dazin 7 H234
ortho-salicylaldehyde azide 7 H233
- Hydroxybenzenearsonic acid and derivs
7 H234–H235
dinitrohydroxybenzenearsonic acid
7 H234–H235
mononitrohydroxybenzenearsonic acid 7 H234
- Hydroxybenzeneazobenzene and derivs
7 H235–H236
dinitrohydroxybenzeneazobenzene
7 H235–H236
mononitrohydroxybenzeneazobenzene 7 H235
2,4,6-trinitro-1-hydroxybenzene- (3 azo 1)-2-
naphthol 7 H236
- Hydroxybenzoic acid and derivs 7 H236–H238
2-bromo-4,6-dinitrohydroxybenzoic acid,
calcium salt 7 H237

- Hydroxybenzoic acid and derivs (cont'd)
 3,5-dinitro-4-hydroxybenzoic acid, copper and lead salts 7 H237
 hydroxybenzoic acid azide 7 H236
 hydroxybenzoic acid, 3-chloro-5-diazo 7 H236–H237
 hydroxybenzoic acid, 4-diazo 7 H237
 hydroxybenzoic acid, 3-diazo-5-nitro 7 H237
 5-nitro-3-hydroxybenzoyl azide 7 H236
 2,4,6-trinitro-3-hydroxybenzoic acid 7 H237–H238
- Hydroxybenzotriazole see Benzotriazole 2 B87; expl derivs 7 H238
 1-bromobenzo-3,4- (3'-azimidole) 7 H238
 4,6-dibrom-1-hydroxy-1,2,3-benzotriazole and hydrazine deriv 7 H238
 4,6-dichlor-1-hydroxy-1,2,3-benzotriazole and hydrazine deriv 7 H238
 3-hydroxybenzotriazole-5-carboxylic acid 7 H238
 hydroxy-6-nitro-1,2,3-benzotriazole-5-acetic acid see Benzotriazol 2 B88
 hydrazine salt of 4-nitro-6-chlor-1-hydroxy-2,3-benzotriazole 7 H238
- Hydroxybenzylaniline, tetranitro deriv 7 H238
- Hydroxybenzyltoluidine, tetranitro deriv 7 H238
- α -Hydroxybibenzyl 7 H238
 2,4,2',4',5'-pentanitrohydroxybibenzyl 7 H238
- Hydroxybutyl and derivs see Butanol and derivs 2 B372
- β -Hydroxybutyraldehyde 1 A15
- Hydroxychlorophenyl and derivs see Chlorophenyl and derivs 3 C362
- 3-Hydroxycumarone-2-azide see 2-Azide-3-coumaranone 3 C548
- 1-Hydroxycyclohexyl-1-hydroperoxide see Cyclohexanone peroxide 3 C598
- 1-Hydroxycycloheptyl-1-hydroperoxide 3 C592
- 1-Hydroxycyclooctyl-1-hydroperoxide 3 C592
- 2-Hydroxy-1,1,3,3-cyclopentanetetramethanol-pentanitrate 7 H239
- 1-Hydroxycyclopentyl-1-hydroperoxide 2 C592
- Hydroxydialkylamines, nitrated derivs 7 H239
- 7-Hydroxy-2,5-diazaheptane see N-Ethanol-N'-methylethylenediamine 6 E183
- Hydroxydichlorobenzene and derivs see Dichlorophenol and derivs 5 D1213
- N-Hydroxyethenylamidooxime 6 E185
- Hydroxydiethylperoxide see Ethylethanol peroxide 6 E294
- Hydroxydimethylperoxide 7 H239
- 2-Hydroxy-3,5-dinitrophenylazide 7 H239
- Hydroxydiphenylamine see Anilinophenol 1 A433; 7 H240
 hydroxy-tetranitrodiphenylamine 7 H240
 4-hydroxy-3,5,2',4',6'-pentanitrodiphenylamine 7 H240
- N-Hydroxyethenylamidooxime see Ethenylamidooxime 6 E185
- Hydroxyethyl see Ethanol and derivs 6 E154
- β -Hydroxyethylaminobenzene see 2-Anilinoethanol and derivs 1 A424–A431
- N-(2-Hydroxyethyl)-butylamine 7 H240
 N-(2-nitroxyethyl)-butylamine (BuNENA) 7 H240
- Hydroxyethylcellulose 7 H240
- N-(2-Hydroxyethyl)-cyclohexylamine 7 H240
 N-(2-nitroxyethyl)-cyclohexylnitramine (cyclohexyl-NENA) 7 H240
- N-(2-Hydroxyethyl)-ethylamine 7 H240
 N-(2-nitroxyethyl)-ethylnitramine (EtNENA) 7 H240
- N-(2-Hydroxyethyl)-gluconamide hexanitrate 7 H240
- N-(2-Hydroxyethyl)-glycolamide dinitrate 7 H240
- Hydroxyethylglycolurethane, N-nitro-dinitrate 7 H240–H241
- Hydroxyethylguanidine and derivs 7 H241
 N-(β -hydroxyethyl)-N'-nitroguanidine 7 H241
 N-(β -hydroxyethyl)-N-nitroso-N'-nitroguanidine 7 H241
 N-(β -nitroxyethyl)-N'-nitroguanidine 7 H241
 N-(β -nitroxyethyl)-N-nitro-N'-nitroguanidine 7 H241

- Hydroxyethylguanidine and derivs (cont'd)
N-(β -nitroxyethyl)-N-nitroso-N'-nitroguanidine 7 H241
- N-(β -Hydroxyethyl)-hydroxyacetamide 7 H241
- N-(β -Hydroxyethyl)-methylamine and deriv 7 H241
N-(β -nitroxyethyl)-methylnitramine (MeNENA) 7 H241–H242
- N-(β -Hydroxyethyl)-N'-methylethylenedinitramine 7 H242
N-(β -nitroxyethyl)-N'-methylenedinitramine 7 H242
- α -Hydroxyethylmethylperoxide 7 H242
- N,N'-Bis(2-hydroxyethyl)-oxamide see Diethylol-oxamide and derivs 5 D1243
- Hydroxyethyl-3-oxy-1,2-propanediol trinitrate 7 H242
hydroxypropyl-3-oxy-1,2-propanediol trinitrate 7 H242
- Hydroxyethylpicramide see Anilino-ethanol and derivs 1 A425
- N-(β -Hydroxyethyl)-N'-phenyl-1,2-diaminoethane and derivs see Anilinoethylaminoethanol and derivs 1 A431
- Hydroxyheptylperoxide 7 H242
- 1-Hydroxy-1'-hydroperoxydicyclohexyl peroxide see Cyclohexanone peroxide 3 C598
- 1-Hydroxy-5-hydroxymethyltetrazole and derivs 7 H242–H243
1-hydroxy-5-nitroxymethyltetrazole 7 H243
- 6-Hydroxyindazole 7 H243
5,7-dinitro-6-hydroxyindazole 7 H243
- Hydroxylamine and derivs 7 H243–H247
hydroxylamine derivs 7 H246–H247
hydroxylamine salts and complexes 7 H245
- Hydroxymethylbenzene see Cresol and derivs 3 C556
- 1-Hydroxy-3-methylcyclohexyl-1-hydroperoxide 3 C592
- Hydroxymethyl hydroperoxide 5 D1303
- 2-Hydroxymethyl-1,3-propanediol-2-aniline and deriv (Heptryl) see Anilinotrimethylolmethane and derivs 1 A441–A442
- 1-Hydroxy-2-propanone see Acetol and derivs 1 A33
- Hydroxymethylbenzoic acid 7 H248
5-hydroxy, 2,4,6-trinitro-3-methylbenzoic acid 7 H248
- Hydroxymethylbutanol (1) trinitrate, 2,2-bis 7 H248
- N-Hydroxymethylethylenedinitramine 7 H248
- Hydroxymethylhydroperoxide 7 H248
- 3-Hydroxy-6-nitro-2-phenylindazole 7 H248
- 1-Hydroxy-2-propanone see Acetol 1 A33
- Hydroxypropylamine see Aminopropanols and derivs 1 A253
N-(2-nitroxypropyl)-nitramine (Iso-Me-NENA) 1 A253
- α -Hydroxypropylethylperoxide 7 H248
- 2-Hydroxypyridine, 3,5-dinitro 7 H249
- Hydroxypyruvic acid 7 H249
- Hydroxyquinoline and derivs 7 H249–H250
dinitro-hydroxyquinolines 7 H249–H250
mononitro-hydroxyquinolines 7 H249
trinitro-hydroxyquinolines 7 H250
- Hydroxyquinone diazides, dinitro derivs of 7 H250
- α -Hydroxytoluene see Benzyl alcohol 2 B91
- 2-Hydroxytoluene see o-Cresol 3 C556
- 3-Hydroxytoluene see m-Cresol 3 C556
- 4-Hydroxytoluene see p-Cresol 3 C556
- Hygiene—industrial, in war plants 7 H250–H251
- Hygrometric tests 7 H251
- Hygroscopicity 7 H251
- Hygroscopicity tests 1 XVI; 7 H251–H254
Brit hygroscopicity test for Blk Powder 7 H251–H252
hygroscopicity test at 15° in a moisture-saturated atmosphere 7 H252
; desiccator test 7 H251
; Fr test (LeRoux) 7 H252
; humidity equilibrium method 7 H252
; specific ingredients 7 H252–H253
; US armed forces test at 30° and 90% RH 7 H252

Hypercompression of expls see Dead-pressed
expls 3 D20

Hypergolic proplnts 7 H254–H259

, expln properties 7 H256

, hypergolic oxidizer and fuel mixtures
7 H255–H256

, ignition delay 7 H254–H255

, physical properties 7 H256

, proplnt performance data 7 H256–H257

, thermochemical and thermodynamic
properties 7 H256

Hyperol or perhydrate 7 H259

Hypervelocity gun 7 H259

Hypervelocity impact: dependence of crater
dimensions on impact velocity 7 H259–H260

Hypochlorous acid and hypochlorites
7 H260–H262

analysis of hypochlorites 7 H261

hypochlorites 7 H260–H261

organic hypochlorites 7 H261–H262

Hypophosphites 7 H262–H263

Hyporka 7 H262

“Hyros” expls 7 H263

- IASP 7 I1
- ICC 7 I1
- Ice blasting by means of expl 7 I1
- ICI 7 I1
- ICT 7 I1
- ICT see Igniter compns for tracers 4 D774
- Ideal and nonideal detonations see
Detonations, ideal and nonideal
4 D389–D390
- Identification of Ammonals 1 A292
- Identification of ammunition and expl devices
7 I1–I4
- Iditol 7 I4
- Ievler expls 7 I4
- Igdamit 7 I4–I5
- Igelit 7 I5
- Igloo magazines 7 I5
- Ignis volatilis 7 I5
- Igniters 7 I5–I10
igniter 7 I6
igniter bag or pad 7 I6
igniter bag (used in rocket) 7 I6
igniter cord 7 I6
igniter cord 7 I6
igniters, delay, electric 7 I6
igniters, electric 7 I7
igniters for firearms (historical)
4 D753–D756
igniters for fuses 7 I7–I8
igniters for proplnts 7 I8–I9
igniter tests 7 I9–I10
- Igniters for fuses used in ordnance items 4 D768
- Igniters, nonmilitary 4 D733
- Ignition 7 I11–I30
elementary theory of 7 I11–I16
ignition cartridge 7 I16
ignition compositions for use with pyrots
7 I20
ignition of firedamp and coal dust 7 I21–I22
- Ignition (cont'd)
ignition or igniting compositions for use with
expls 7 H16–H20
ignition, spontaneous of expls 7 I24–I25
ignition tests 7 I25–I30
ignition theory of expls 7 I30
- Ignition, definition of 4 D757
- Ignition, prime 4 D757
- Ignition temperature test 1 XVI–XVII; see
Deflagration temperature test 3 D40;
Flash point 6 F80–F96
- Ignition time tests 1 XVII; see Explosion-time
test of double base propellants 6 E389
- Illuminating devices and compositions 7 I31–I32
- Illuminating projectiles or light rockets (star
shells) 7 I32
- Image converter camera 2 C14
- Imatrex 7 I32
- I.M. filling 7 I32
- Imidazole or glyoxaline and derivs see
1,3-Diazole and derivs 5 D1165–D1166
- 2-Imidazolidine see Ethyleneurea 6 E291
- Imidazolines, imidazolidines, imidazolones,
imidazolidones; their derivs and nitrated products
7 I33–I34
1,3-dinitro-imidazolidine 7 I34
1,2-dinitro-iminoimidazolidine, silver salt
7 I39
1-nitro-2-nitramino- Δ^2 -imidazoline 7 I33
1-(N-nitroguanyl-N-nitro- β -aminoethyl)-
2-nitrimino-3-nitroimidazolidine 7 I33–I34
1- β -nitroxyethyl-2-nitrimino-3-nitroimidazoli-
dine 7 I33
- Imide see Ammides, imides and derivs
1 A168–A171; 7 I34
- Iminobisaceticazide see Diglycolamidic diazide
5 D1262.
- Iminodiethanol-dinitrate see Di-(2-nitroxyethyl)-
nitramine (DINA) 5 D1240–D1242
- Iminodihydropurines see Aminopurines and
derivs 1 A154

- 3-Imino-5-phenylimino-1,2,4-triazoline
7 I34–I35
- Iminosuccinylazidic acid 7 I35
- 2-Imino-1,3,4-thiadiazoline and derivs see
Aminothiadiazole and derivs 1 A262–A263
- 2-Iminothiazoline and derivs see Aminothiazole
and derivs 1 A263–A265; 7 I35
nitrosiminothiazoline 7 I35
- 5-Imino-1,2,3,4-thiotriazoline see 5-Amino-
1,2,3,4-thiotriazole 1 A164
- 5-Imino-2-thion-1,3,4-thiodiazolidin 1 A224
- Impact-friction pendulum test 1 XVII, A354
- Impact, initiation of explosion by 7 I35–I55
, experimental evidence 7 I48–I55
, figure of insensitiveness (FI) 7 I38, I41–I43
impact machines and impact tests 7 I36–I42
, summary 7 I44–I48
, theoretical considerations 7 I43–I44
- Impact of a layer of expl by a metal plate,
oblique 4 D461
- Impact sensitivity of expls, bullet 4 D153
- Impact sensitivity test 1 VII, XVII;
5 D1550–D1555
- Impact velocity 7 I55–I56
- Impedance, acoustic and shock 7 I56
- Imperial Schultz powder 7 I57
- Imperiali expl 7 I57
- Implosion 7 I57
- Impulse 7 I57–I63
, comparison of experiment and theory
7 I59–I62
, effect of attenuators 7 I62–I63
, theoretical consideration 7 I57–I59
- Impulse of a primer 7 I63
- Impulse, specific 7 I63
- IMR proplnt 7 I64
- Incendiary “blue pencil” 7 I64
- Incendiary bomb fires and their extinction
7 I64–I65
- Incendiary warfare 7 I65–I83
- Incendiary warfare 7 I65–I83
, bombs used during WWII 7 I75–I78
, chemical abstracts update (to 1975)
7 I79–I83
, historical 7 I65–I75
- Incendiary flash tests for small arms ammunition
7 I83
- Incident wave in blast 2 B182–B183
- Increments see Base charge of a proplnt 2 B24
- Increment appoint (Fr) 7 I83
- Inc T or IT 7 I83
- Indazolone, 5,7-dinitro 7 I83
- Index of damage 7 I83
- Index of ignition see Index of inflammability
1 XVII
- Index of inflammability 1 XVII, XXII–XXIII
- India saltpeter 7 I84
- Indicator test paper for detecting stability of
double-base proplnts 7 I84
- Indice nitrometrique (Fr) 7 I84
- Indigo, 5,5'-dinitro 7 I84
- Indigo, 6,6'-dinitro 7 I84
- Indole-carbonic acid, 5,7-dinitro 7 I84
- Indole-carbonic acid, 5,7,X-trinitro 7 I84
- Induced ground waves see Damage potential of
air and ground blast waves 3 D4
- Induction period see Delay to ignition 3 D53
- Indurite 7 I84–I85
- Industrial expls see Agriculture and forestry use
of expls 1 A112; Blasting expls 2 B202;
commercial or industrial expls 3 C434;
Dynamites 5 D1584
- Industrial disaster control 7 I85
- Industrial fire protection 7 I85–I93
classification of fires 7 I85
definition of “fire” 7 I85
fire protection 7 I86–I87
, definition of terms 7 I85–I86
, loss limitation 7 I91–I93
, sources of ignition 7 I87–I91

- Industrial hygiene 7 I93–I94
- Inert gases' expls compounds 7 I94
- Inert simulants for high expls 7 I95
- Inertial, terrestrial and celestial guidance systems for missiles 7 I95
- Infallible powder 7 I95
- Infallible proplnt 7 I95
- Infantry rocket weapons 7 I95–I96
 Bazooka 7 I95
 Entac 7 I95–I96
 light anti-tank weapon (LAW) 7 I96
 medium assault weapon (MAW) 7 I96
 Redeye 7 I96
 rocket launcher, 3.5 inch 7 I95
 TOW 7 I96
- Infernal machines 7 I96
- Inflammability limits 7 I98
- Inflammability 7 I96–I97
- Inflammability of dust clouds 7 I97
- Inflammability of expls, tests 7 I97–I98
- Inflammability tests 1 XII–XXIII; see Inflammability of explosives tests 7 I97–I98
- Inflame tests, capability to 1 IX
- Influence tests see Detonation by influence or sympathetic detonation tests 1 X;
 4 D395–D402; 7 I98–I100
- Infrared spectroscopy, application to expls and proplnts 7 I100–I102
- Influence test see Gap test 1 XIV
- Ingelite see Antigal de surete 1 A466
- Ingold, C.K. 7 I102
- Inhabited building 7 I102
- Inhibiting of solid proplnt grains 7 I102–I104
 castable cellulose acetate inhibitors for
 rocket proplnts 7 I103–I104
 gel lacquer formulations 7 I103
 inhibiting double base rocket proplnts at PA
 7 I104
 inhibiting of cast double-base grains 7 I103
 inhibiting of double base catapult proplnts
 with ethyl cellosolve gel lacquers 7 I103
- Inhibiting of solid proplnt grains (cont'd)
 , by denitration 7 I102–I103
 by the spiral wrapping process 7 I103
- Inhibitors 7 I104
- Inhibitors in expls 7 I104
- Inhibitor strips for smokeless powders
 7 I104–I105
- Initial velocity 2 B7–B8; 7 I105; 8 M162–M163
- Initiating devices 4 D733–D928
- Initiating efficiency (initiating value or strength)
 of initiating expls, blasting caps and detonators, determinations 1 XVIII
 same as Initiating power, strength or value
- Initiating efficiency of detonators by the miniature cartridge test 1 XVIII; see Miniature-cartridge test 8 M135
- Initiating efficiency (or strength) of primary expls by sand test 1 XVIII
- Initiating expls 7 I105–I106
- Initiation 7 I106–I109
 by bullet impact see Bullet tests
 2 B332–B340; 4 D153
 by electric fields 7 I106
 by electron beams 7 I106–I107
 by electrostatic discharge 5 E36–E54
 by exploding bridgewire 4 D807–D810;
 5 E23; 6 E355–E356; 7 I107
 by fission fragments 7 I107
 by flame 7 I107
 by friction see Friction sensitivity tests
 6 F204
 by gas detonation 7 I107
 by hot fragments 7 I107
 by hot wire 7 I107–I108
 by impact 5 D1549–D1554; 7 I108
 by precursor 7 I108
 by primers 7 I108
 by projectile impact 7 I108
 by radio frequency 7 I108
 by shock 7 I108
 by sparks 7 I108–I109
 , spontaneous 7 I109
- Initiation sensitivity by electrostatic discharges or by sparks 1 XII–XIII see Electrostatic discharges and sensitivity of explosives to initiation by them 5 E38–E55

- Innesco 7 I109
- Inorganic high energy oxidizers 7 I109
- Inositol and derivs 7 I109–I110
inositol hexanitrate (IH) 7 I109–I110
- Inspection of ammunition and of expls 7 I110
- Instantaneous fuse 7 I110
- Instantaneous photography 2 C13–C19
- Instrumentation and instrumental methods of analysis 7 I110–I111
- Instrumentation for studying expls 2 C13–C19; 3 C305–C319; 7 I111
- Intensive incendiary agent 7 I111
- Interferometers, applications to the study of expln and propulsion phenomena 7 I111–I113
- Interior ballistics see Ballistics 2 B7
- Intermittent detonator device 7 I113–I114
- Intermittent illumination 2 C13–C19
- Intermolecular (detonation) equation of state 4 D228
- Internal ballistics of barrel weapons and of solid proplnt rockets 7 I114
- Internal energy 7 I114
- International 75° test 1 XVII
- International committee tests 7 I114
- International heat test see Physical tests 1 XVIII
- International regulations 7 I114–I115
- Interrupter burner test 7 I115
- Interstate Commerce Commission (ICC) regulations 7 I115
- Interplant distances 7 I115
- Intrinsic pressure see Detonation (and expln), equations of state, introduction 4 D269
- Introduction to detonation equations of state 4 D268
- Introduction to the Encyclopedia 1 I–VI
nomenclature 1 II–VI
- Inulin 7 I114
- Inulin trinitrate 7 I115–I116
- Iodated and nitrated paraffins 7 I116–I117
iododinitromethane 7 I116
iodotrinitromethane 7 I116–I117
- Iodates and periodates 7 I117–I118
ammonium iodate 7 I117
ammonium periodate 7 I117–I118
hydrazinium iodate 7 I118
- Iodides 7 I118–I120
nitrogen iodide 7 I118–I120
- Iodides in smoke compositions 7 I121
- Iodine 7 I121
- Iodine azide 1 A542–A543
- Iodine fluoride 6 F143
- Iodine pentafluoride 7 I121
- Iodoazide see Azides, inorganic 1 A542–A543
- Iodosoazidobenzene see Benzene and derivs 2 B44
- Iodoxyazidobenzene see Benzene and derivs 2 B44
- Iodoazidoethane 7 I121
- Iodoazoimide 7 I121
- Iodobenzene and derivs 7 I121–I122
dinitriodobenzene 7 I121
mononitriodobenzene 7 I121
1,3,5-trinitro-2-iodobenzene 7 I122
- 1-Iodo-2-ethoxy-3-butene 7 I122
- Iodomethane and derivs 7 I122
diodomethane 7 I122
iodoform 7 I122
iododinitromethane 7 I122
iodonitromethane 7 I122
iodotrinitromethane 7 I122
- 2-Iodo-2-nitro-1,3-indandione 7 I122–I123
- Iodonitrophenols 7 I123
- Iodoso compounds 7 I123–I124
azidoiodosobenzene 7 I123
1,3-di-iodosobenzene 7 I124
iodosobenzene 7 I123
1-iodoso-2-chlorobenzene 7 I123

- Iodoso compounds (cont'd)
 1-iodoso-3-iodobenzene 7 I124
 X-iodoso-Y-nitrotoluenes 7 I124
 4-iodoso-1-propylbenzene 7 I124
 m-iodosotoluene 7 I124
- Iodotoluenes and derivs 7 I124
- Iodoxy compounds 7 I124–I126
 azidiodoxybenzenes 7 I124–I125
 1,3-di-iodoxybenzene 7 I125
 dinitriodoxy benzenes 7 I125
 iodoxybenzene 7 I124
 1-iodoxy-4-bromobenzene 7 I125
 1-iodoxy chlorobenzenes 7 I125
 1-iodoxy-2,5-dibromobenzene 7 I125
 1-iodoxy-2,5-dichlorobenzene 7 I125
 iodoxy-1,3-dimethylbenzene 7 I126
 1-iodoxy iodobenzenes 7 I125
 4-iodoxy-1-isoamylbenzene 7 I126
 4-iodoxy-1-methylethylbenzene 7 I126
 4-iodoxy-1-propylbenzene 7 I126
 4-iodoxy-1-tert-butylbenzene 7 I126
 iodoxy toluenes 7 I125–I126
 iodoxy trimethylbenzenes 7 I126
 mononitriodoxybenzenes 7 I125
- Ion exchange 7 I126–I128
- Ion exchange chromatography 3 C294
- Ionization in detonation and shock waves
 4 D258 ff; 7 I128–I132
 ionization in a detonation wave 7 I128–I129
 shock ionization in condensed media 7 I129
 shock ionization of gases 7 I129–I132
- Ions; action on expls 7 I132
- IPA composition 7 I132
- Ipatieff, V.N. 7 I132–I133
- IRECO Chemicals 7 I133–I134
- Irradiation of expls with high speed particles
 7 I134
- Iron acetylde 1 A76
- Iron azide 1 A543–A544
- Iron carbide 1 A76
- Iron chlorides 3 C239
- Iron, powder for pyrotechnics 7 I135
- Iron-oxide-TNT test for detonators 1 XVIII
 same as Miniature cartridge test 8 M135
- Isano oil 7 I135
- Isazaurolin 7 I135
- Isoamylamine see Amylamine 1 A395
- Isoamylpicrate see iso-Amylpicrate 1 A399
- Isoamylureidoacetyl azide 1 A399
- Isobutane 2 B368
- Isobutanediol 2 B370
- Isobutanol 2 B372
- Isobutyl alcohol 2 B372
- Isobutyryl peroxide see Di-iso-butyryl peroxide
 5 D1201
- 2-Isocyanate benzoyl azide see 2-Azidoformyl-
 phenylisocyanate 1 A638
- 2-isocyanatobenzoylazide see 2-Azidoformyl-
 phenylisocyanate 1 A638
- Isocyanic acid see Cyanic acid 3 C582
- Isocyanogen tetraazide 7 I135
- Isomelamine see Cyanuramide 3 C589
- Iso-Me-NENA same as Nitraminopropanol
 1 A253
- Isomers 7 I136
- Isomers of Trinitrotoluene 7 I136
- Isonitramines 7 I136
- Isonitrosocyanoacetic acid 3 C584
- Isonitrosocyanoacetic acid methyl ester 3 C584
- Isonitrosocyanoacetyl azide 3 C584
- Isonitrosocyanoacetyl hydrazide 3 C584–C585
- Isoolefin polymers 7 I136
- Isopicramic acid see 2,6-Dinitro-4-amino-phenol
 1 A243
- Isoprene peroxide, polymeric 7 I136
- α -isopropylacrolein oxime 1 A129
- Isopropyliden-di-cyclo-hexyliden-triperoxyd
 (Ger) see 1,1'-Bis (hydroperoxycyclohexyl)-
 peroxide 2 B144

Isopropyl toluene see Cymenes 3 C637
Isopurpuric acid 7 I137
 potassium isopurpurate 7 I137
Iso-trioil 7 I137
Isotrotyl 7 I137
X-Isloxazoleazotrinitromethane 7 I138
 α -Isloxazolecarboxylic acid and deriv 7 I137
 α -isloxazoleazide 7 I137
4-(3-Isloxazolyl)-3-furazancarboxylic acid 7 I138

Italian expls and related items 7 I138–I184
 alphabetical list of Italian expls and related
 items 7 I140–I184
 , introduction 7 I138
 principal Italian factories manufacturing
 expls and related items 7 I138–I140
Ivory nut 7 I148
Ivory nut, nitrated 7 I184
Izod test see Charpy and Izod tests 2 C154
Izzo, A. 7 I184

- Jablonsky's proplnt 7 J1
- Jacket 7 J1
- Jacket, bullet 7 J1
- Jacket, coolant 7 J1
- Jacketed projectile 7 J1—J2
- Jacque stability test 7 J2
- Jahnite powders 7 J2
- Jalnias powders 7 J2
- JANAF 7 J2
- Janite 7 J2
- JANNAF 7 J2
- Jannopoulos test 7 J2
- Janovsky test see Color reactions and reagents
3 C405; 7 J2
- Japanese expls, ammunition and weapons
7 J2—J67
 alphabetical list of Japanese expls and related
 items 7 J3—J67
 , introduction 7 J2—J3
 , system of designation 7 J3
- Japanese HE bomb trains 2 B224
- Jarrett, G. Burling 7 J67
- Jatos 1 A384 see JATO 7 J67
- Joffe (detonation) equation of state 4 D282
- JB-2 bomb 7 J67
- JB powders 7 J67
- JCP powder 7 J68
- Jelly bag method of mixing see Drums . . .
(mixing) . . . expls . . . 5 D1556
- Jelly, mineral 7 J68
- Jensen's test 7 J68
- Jetcord 7 J68
- Jet formation in shaped charges 7 J68
- Jet fuels 7 J68—J75
 jet fuel patents 7 J73
 , introduction 7 J 68
 jet fuels (JP-3 to -6) 7 J68—J73
- Jet fuels (cont'd)
 , US military specification (for JP-3 to -5)
 MIL-T-5624J (1973) 7 J73—J75
- Jet perforators and jet tappers 7 J75—J77
- Jet propulsion 7 J77—J83
 , introduction 7 J77—J78
 types of jet propulsion engines 7 J78—J82
- Jet propulsion, history of 7 J83—J84
- Jet propulsion unit "decipede" 7 J84
- Jet pumps 7 J84
- Jewel powder 7 J84
- Jeweler expls see Ievler expls 7 I4
- Johnson & Alexander priming composition 7 J84
- Jolt & jumble tests 7 J84—J85
- Jones and Jones-Miller (detonation) equation of
state 4 D282
- Jones detonator loader 7 J85
- Jones blasting expls 7 J85
- Jones Dynamite 7 J85
- Jones smokeless powder 7 J85
- Jordan pulping machine 7 J85—J86
- Jouguet, (Jacques-Charles) Emile 7 J86
- Jouguet's rule 4 D607
- JP, JPH and JPN proplnts see Ballistite 2 B9
- J (poudre de chasse) 7 J1
- Judson Dynamite 7 J86
- Juinite see Ethylenebisurethane and derivs 6 E234
- Jump firing test 7 J86
- Jumping detonation 4 D421
- Junk test see Bergmann-Junk test 2 B102
- Juno 1 7 J86
- Juno 2 7 J86—J87
- Juniper C 7 J87
- Jupiter Dynamite 7 J87
- Justice powder 7 J87
- Jute 7 J87

K

- K₁ and K₂ (of Muraour) 7 K1
 K-1 expl (Russ K-1) 7 K1
 K-2 expl (Russ K-2) 7 K1
 Kadinite 7 K1
 Kaipinites 7 K1
 Kaliialmatrit no 55 see Almatrites 1 A140
 Kalinite 1 A156
 Kallenites 7 K1
 Kamikaze bomb see Baka bomb 2 B4
 Kanaite 7 K1
 Kanone (Ger) 7 K1
 Kapsiul 7 K1
 Kapsuil' detonator 7 K2
 Kapsuil' vosplamenitel 7 K2
 Kapsuil' vosplamenitel' trobochnye 7 K2
 Kardox cartridge see Cardox 2 C67
 Karitto see Carlit 2 C68; 7 J36
 Karl Fischer method for determination of
 moisture see Dynamites 5 D1622;
 Ethanol 6 E158
 Karman, Theodor von 7 K2
 KA-salz 7 K2
 Kast brisance meter see Brisance 1 IX,
 Compression tests X; Brisance 2 B265–B297,
 Brisance test methods 2 B299–B300
 Kast, H. 7 K2–K3
 Katiusha 7 K3
 Kcilil or Ksilil see Trinitroxylyene, commercial
 5 D1324–D1325
 KDNBF 2 B68
 Keeping test 7 K3
 Keil expl 7 K3
 Kekule oil 7 K3
 Kelbar Powder Co expl 7 K3
 Kelbetz expls 7 K3
 Kellow and Short 7 K3
 Kelly, Bell and Kirk expl 7 K3
 Kent, Robert H. 7 K3
 Kent powder 7 K3–K4
 Kentite 7 K4
 Kerosene 7 K4
 Kerosene nitrate 7 K4
 Kerr cell see Cameras, high-speed photographic
 2 C15
 Kessen expls 7 K4
 Ketocyclopentane see Cyclopentanone 3 C603
 Ketoexamethylene see Cyclohexanone 3 C597
 Ketone peroxides 7 K4
 2-Ketotrimethyleneimine see 2-Azetidinone
 1 A519
 Ketoximes and derivs 7 K5
 Keyes (detonation) equation of state 4 D283
 Keystoneite see Alkalies, action on aromatic
 nitrocompounds 1 A126
 KH-charge 7 K5
 Kickless or recoilless weapons 7 K5–K6
 Kier 7 K6
 Kiering 7 K6
 Kiernan and Bowen expl 7 K6
 Kieselguhr or guhr 7 K6
 Kihara & Kikita (detonation) equation of state
 4 D283
 KI-heat test see Abel's test 1 A2
 Kinenite 7 K6
 Kinetics in expln phenomena 7 K6–K13
 application of kinetics to expln phenomena
 7 K9–K11
 kinetic data 7 K11–K12
 , introduction 7 K6–K7
 , review of chemical kinetics 7 K7–K9
 Kinetite 7 K13

- Kinite 7 K13
 Kirsanov expl 7 K13
 KI-starch test see Abel's test 1 A2
 Kistiakowsky-Halford-Wilson-Brinkley
 (detonation) equation of state 4 D283
 Kistiakowsky-Wilson (detonation) equation of
 state 4 D284
 Kittitas 7 K13
 Krivit 7 K13
 Kjeldahl, J. 7 K13
 Kjeldahl method 7 K13-K14
 Klaffke's expl 7 K14
 Klepydra see Chronographs 3 C308
 KMA block (Ger) see Ersatzsprengstoffe 5 D122
 Knallgalert 7 K14
 Knallgas (Ger) 7 K14
 Knallquecksilber (Ger) see Mercuric fulminate
 6 F217-F223
 Knallsilber (Ger) see Silver fulminate
 6 F223-F224
 Knallzundschnur (Ger) see Detonating cords
 3 D103-D107
 Knecht compound 7 K14-K15
 Knetmaschine (Ger) 7 K15
 Kochsalzsprengstoffe 7 K15
 Kofler micro hot stage appar 7 K15
 Kohlen-Albit (Ger) 7 K15-K16
 Kohlensprengstoff 7 K16
 Kohler powder 7 K16
 Kolax 7 K16
 Kolfit (Ger) 7 K16
 Kolf's blasting powder 7 K16
 Kolf's powder 7 K16
 Kollodiumwolle (Ger) 7 K17
 Kolner Dynamit fabrik 7 K17
 Koln-Rottweiler Sicherheitssprengpulver 7 K17
 Kolowratnik's expls 7 K17
 Konig expls 7 K17
 Konovaloff reaction 7 K17
 Kontinuierliche verfahren 7 K17
 Koronit 7 K17
 Koronit or Favorit 7 K17
 Koronit V 7 K17-K18
 Kostevich, Michael M. 7 K18
 K (pulver) see Erosion of gun barrels 5 E116
 Kraft Dynamite 7 K18
 Kraftzahl (KZ) probe see Trauzl test
 1 XXV-XXVI; 7 K18
 Kratites 7 K19
 Kreulen's Al block see Al block (of Kreulen)
 1 A145
 Krummerlauf (Ger) see Bent barrel gun 2 B34
 K-salz (Ger) see Cyclonite 3 C611
 KSG powder 7 K19
 KS powder 7 K19
 K₃-stoff (Ger) 7 K19
 Ksilil 7 K19
 Kubin expls 7 K19
 Kubin & Sierch 7 K19
 Kumuliatwnyfi zariad 7 K19
 Kup powder 7 K19
 Kurzschlusszunder (Ger) 7 K19
 Kury (detonation) equation of state 4 D284
 Kynarite 7 K19
 Kynite 7 K19
 Kynite, condensed 7 K20
 Kynoch Gelignite 7 K20
 Kynoch limited 7 K20
 Kynoch smokeless powder 7 K20

L

- LA same as Lead azide 1 A545–A587
- Labels for shipping expls and other dangerous materials 7 L1
- Labile NC 7 L1
- Lactic acid nitrate 7 L1
- Lactose and derivs 7 L1–L2
 lactose hexanitrate 7 L2
 lactose octanitrate 7 L2
- Lafaye expls 7 L2
- Lafin and Rand Powder Co 7 L2
- Lake's expl 7 L2
- L-alloy 7 L1
- Lambotte expls 7 L2
- Laminac 4116 7 L3
- Laminated powders 7 L3
- Lamm expls 7 L3
- LaMotte's expl 7 L3
- Lance missile (XMGM-52A) 7 L3
- Land 7 L3–L4
- Landauer expls 7 L4
- Land mines 1 A384 see Mines (military)
 8 M131–M133
- Landau-Stanyukovich (detonation) equation of state 4 D285
- Landau-Stanyukovich-Zel'dovich-Kompaneets (detonation) equation of state 4 D285
- Landsdorf Dynamite 7 L4
- Landsdorf powder 7 L4
- Landskrona powder 7 L4
- Lanthanum triazide 1 A544
- Lanthium triazide 1 A544
- Laser, application to expl and weapons technology 7 L4–L6
- Latent heats of fusion, vaporization 7 H58
- Launchers 2 C28; 6 G139
- Launoy powder 7 L6
- Lava fire bomb 7 L6
- Lavoisier, A.L. 7 L6
- LAW 7 L7
- LDNR see Lead 2,4-dinitroresorcinat
 5 D1274–D1275
- LDNR, basic see Lead 4,6-dinitroresorcinat,
 basic 5 D1275–D1276
- Lead 7 L7
- Lead acetates 1 A28–A29
- Lead aceto-bromate 1 A29
- Lead aceto-bromate to Na perchlorate 1 A29
- Lead aceto-chlorate 1 A29
- Lead aceto-perchlorate 1 A29
- Lead acetylde 1 A76
- Lead-antimony 7 L7
- Lead azide (LA) 1 A545–A563
 destruction of LA 1 A551
 expl properties of LA 1 A548–A551
 history 1 A545–A546
 laboratory preparation of dextrinated LA
 1 A546–A547
 lead azide, basic 1 A555–A556
 lead (IV) azide 1 A556
 lead azide, various military types 1 A557
 plant manufacture of dextrinated LA by the
 duPont method 1 A547–A548
 property comparison of LA 1 A559–A562
 properties of LA 1 A545–A546
 uses of LA 1 A551–A552
- Lead azide plant, analytical procedures
 1 A563–A580
 ball drop test 1 A573
 disposal of lab samples containing azides at
 KOW 1 A574
 dextrin 1 A564–A565
 ethyl alcohol solution 1 A573
 killing tank 1 A573–A574
 laboratory disposal of LA by the British
 method 1 A575

- Lead azide plant, analytical procedures (cont'd)
 laboratory and plant disposal of LA by the
 method used at the duPont plant at
 Pompton Lakes, NJ 1 A575
 laboratory disposal of LA by the method
 used at Picatinny Arsenal 1 A575
 laboratory disposal of LA by the method of
 Wm Rinckenbach 1 A574—A575
 laboratory tests for the presence of LA
 1 A575
 lead azide by military specification
 1 A567—A572
 lead azide expl primer and detonator
 compositions 1 A576—A587
 lead nitrate 1 A563—A564
 lead nitrate dilution tank 1 A565
 moisture in dried LA 1 A572
 moisture in wet LA 1 A572—A573
 moisture in wet LA by density measurements
 1 A573
 nitric acid for killing 1 A574
 refined sodium azide liquor 1 A565—A567
 sodium azide dilution tank 1 A567
 sodium azide feed tank 1 A567
- Lead azidodithiocarbonate 1 A637
- Lead bichromate see Lead dichromate 3 C284
- Lead block compression test 3 C492—C493
- Lead block expansion test see Trauzl test
 1 XXV—XXVI
- Lead block (or cylinder) compression (or
 crushing) test see Compression test
 1 VII—IX; 2 B299—B300
- Lead bromate 7 L8
- Lead carbonate 2 C59
- Lead carbonate, basic 2 C59
- Lead chlorate (basic) 2 C189
- Lead chlorate (normal) 2 C188—C189
- Lead chlorite 3 C245
- Lead chromate 3 C280—C281
- Lead dichromate 3 C284
- Lead 2,4-dinitroresorcinate, basic (LDNR,
 basic) 5 D1275—D1276
- Lead 4,6-dinitroresorcinate, basic (LDNR,
 basic) 5 D1275—D1276
- Lead 2-ethylhexoate 6 E299
- Lead fluoride 6 F143
- Lead hydroxide-2,4,6-trinitroresorcinate
 5 D1277
- Lead imide 1 A169
- Lead 2-mononitroresorcinate (LMNR)
 5 D1271—D1273
- Lead nitroaminoguanidine 1 A212
- Lead-5-nitro-furyl- β -acrylate 6 F247
- Lead oxides 7 L9—L10
 lead oxide brown or lead dioxide 7 L9
 lead oxide or lead tetraoxide 7 L9—L10
 lead oxide yellow or litharge 7 L9
- Lead plate test see Plate tests 1 XX
- Lead salts of nitrocompounds 7 L10
- Lead salts of trinitroresorcinol, other 5 D1288
- Lead-shot metal 7 L10
- Lead-sodium thiosulfate 7 L10
- Lead styphnate, basic 5 D1277—D1278
- Lead styphnate, normal (LSt) 5 D1278—D1288
- Leads (used in expl trains) 4 D869
- Lead tetraethyl 7 L11
- Lead thiocyanate 7 L11
- Lead trinitroresorcينات see Trinitro derivs of
 dihydroxybenzene 5 D1277 ff
- Leaking gun 2 C28; 7 L11
- Lecithin 7 L11
- Lecorche-Jovinet sensitivity test 7 L11
- Lederite 7 L11
- LEED 7 L12
- Lees (detonation) equation of state 4 D287
- Le Marechal powders 7 L12
- Length and duration of flame test see Flame test
 1 XII, XVII, XXIII; 6 F54
- Lennard-Jones & Devonshire (detonation)
 equation of state 4 D287; 7 L12
- Lenite 7 L12

- Leonard's smokeless powders 7 L12
- Leomit 7 L12
- Le Roux hygroscopicity test 7 H252–H254
- Lesmok powder 7 L12
- Le Sueur's expl 7 L12
- Leuschel expls 7 L12
- Levoglucosan trinitrate see Fructosan trinitrates
6 F208
- Levulose 6 F208
- Levulose trinitrate 7 L12
- Lewin expls 7 L13
- Lewisite see Arsine and derivs 1 A491; 7 L13
- Lezinsky's expl 7 L13
- L.F. Dynamites see Low-freezing Dynamites
5 D1584, D1588–D1593
- L.G. powder 7 L13
- Liardet expls 7 L13
- Lichenin 7 L13
- Lichenin pentanitrate 7 L13
- Liebert 7 L13
- Liebert Dynamites 7 L13
- Life of guns see Erosion of gun barrels
5 E112–E120
- Ligdyn 7 L14
- Light anti-tank weapon (LAW) 7 I96
- Light, effect on expls 7 L15
- Light emission from detonation and expls see
Detonation, . . . luminosity . . . produced on
4 D425–D434, also Detonation . . . and
spectrographic measurements in D548–D549
- Lightning protection 7 L14–L15
- Lignin 7 L15
- Lignin nitrate 7 L15
- Lignin Dynamites 7 L15–L16
- Lignite 7 L16
- Limiting charge see Charge limit 2 C151–C153
- Limiting charge density-diameter of expl charges
see Detonation velocity, charge diameter and
density relationship 4 D641–D656
- Limparicht expls 7 L16
- Limpet charge 7 L16
- Lindeman expl 7 L16
- Lindner expl 7 L16
- Linear shaped expl charges 7 L16–L17
- Lined cavities of expls see Detonation,
Munroe Neumann effect . . . 4 D444–D450
- Line wave generator 7 L17–L18
- Linen fiber 7 L18
nitrated linen fiber 7 L18
- Linolein 7 L18
linolein nitrate 7 L18
- Linseed oil 7 L18–L19
- Linters 7 L19
- Liquefaction test 7 L19
- Liquid air and liquid oxygen expls (LOX)
7 L19–L26
 - , detonation and sensitivity characteristics
7 L22–L24
 - , history 7 L20
 - , list of recent patents on LOX 7 L24–L25
 - , typical LOX compositions 7 L20–L21
 - , uses 7 L21–L22
- Liquid expls 7 L26–L34
 - , brief abstracts of recent publications in
7 L33
 - , detonation phenomena in 7 L28–L31
 - , history 7 L26–L27
 - , initiation of detonation in 7 L31–L33
 - , specialized uses of 7 L27–L28
 - , typical liquid expls 7 L27
- Liquid proplnts 7 L34–L44
 - , definitions and overview of 7 L34–L35
 - , history of 7 L35–L36
 - , representative applications of 7 L39–L42
 - , representative compositions of 7 L36–L39
 - , sensitivity and hazards of 7 L43–L44
- Liquid TNT see Drip oil 5 D1546–D1547
- Lithium-Al hydride see Al-Li hydride 1 A154–A155

- Lithium azide 1 A588–A589
- Lithium boroazide 1 A525
- Lithium carbide 1 A77
- Lithium chlorate 2 C189
- Lithium fluoride 6 F127
- Lithium nitrate 7 L45
- Lithium perchlorate 7 L45
- Lithoclastites 7 L45
- Lithofracteur 7 L45
- Lithorite 7 L45
- Little David 7 L45
- Livens projector 7 L45–L46
- LMNR see Lead-2-mononitroresorcinat
5 D1271–D1273
- Loading and fabrication of expls 7 L46–L57
 , casting 7 L46
 , effect of casting procedure on charge
 characteristics 7 L46–L47
 , finishing operations 7 L55
 , pressing 7 L48–L53
 , process selection 7 L46
 , some special casting techniques 7 L47–L48
 , special procedures 7 L53–L54
 , standard casting procedure 7 L47
- Loading factor 7 L57
- Lobbe expl 7 L57
- Locust-gum 7 L57
- Logistics 7 L57
- Long Tom 7 L57
- Lorentz (detonation) equation of state 4 D288
- Loss of weight stability tests 7 L57
- Lovelace 7 L58
- Low detonation pressure expls 7 L58
- Low energy detonating cord (LEDC) 7 L58
- Low expl (LE) 7 L58
- Low-expl devices for performing mechanical
functions 7 L58
- Low freezing Dynamites see Dynamite . . .
5 D1588–D1593
- Low melting ammonium nitrate expls see
Ammonium nitrate blasting expls . . .
1 A346–A348, A352
- Low order burst 7 L59
- Low order detonation see Detonation, high,
low and intermediate order, velocities of
4 D384–D389
- Low panel test 3 C350
- Low temperature effect on expl properties 7 L59
- LSt see Lead styphnate, normal 5 D1278–D1288
- Lubrication 7 L59–L60
 , expl 7 L60
 , fuze 7 L59
 , space application 7 L60
- Luck and Cross 7 L61
- Luck and Durnford 7 L61
- Luck powder 7 L61
- Luminous phenomena 7 L61
- Lundholm and Sayers 7 L61
- Lunge, Georg 7 L61
- Lunge nitrometer 7 L61
- Lupersol DDM 7 L61
- LX expls 7 L62; see also PBX 8 P60–P77
- Lycopodium 7 L63
- Lyddite 7 L63
- Lysol and nitrated deriv 7 L63
 nitrolysol 7 L63

M1**M**

- M1 thickener 8 M1
M2 thickener 8 M1
M4 thickener 8 M1
Macarites 8 M1
Macaroni press 8 M1–M2
MacEvoy 8 M2
MacGavin expl 8 M2
Machine gun 8 M2
Mach number 8 M2
Mach stem 8 M2
MacKentosh proplnts 8 M2
Macleod (detonation) equation of state 4 D288
Magazine 8 M2–M3
Magnesium 8 M2–M6
Magnesium acetylide 1 A77
Magnesium (analytical procedures) 8 M6–M8
Magnesium arsenide 1 A491
Magnesium carbonate 8 M8
Magnesium chlorate 2 C189
Magnesium diazide 1 A589
Magnesium fluoride 6 F143
Magnesium fluorsilicate 6 F144
Magnesium-methanol (or water) expls 1 A155
Magnesium oxide 8 M9
Magnesium sulfate 8 M9
Magnet fuse 8 M9
Magneto exploder 8 M9–M10
Magnus force 8 M10
Mahieu chronograph 8 M10
Maintenance 8 M10
Maize starch 8 M10
Maizite 8 M10
Malononitrile see Dicyanomethane 5 D1218
Maltose and derivs 8 M10–M11
 maltose octanitrate 8 M10–M11
Maltobenzit 8 M11
Mammoth powder 8 M11
Manganese 8 M11
Manganese acetylide 1 A78
Manganese carbide 1 A78
Manganese chlorate 2 C189
Manganese delay compositions 8 M11–M12
Manganese diazide 1 A589–A590
Manganese heptoxide 8 M12
Manganese nitrate 8 M12
Manganic fluoride 6 F144
Manganous fluoride 6 F144
Manlianite 8 M12
Mannans and deriv 8 M12
 trinitromannan 8 M12
Mannitane and deriv 8 M13
 mannitane tetranitrate 8 M13
Mannitol and derivs 8 M13–M16
 mannitol hexanitrate 8 M13–M15
 mannitol pentanitrate 8 M16
Mannol see n-Ethylacetanilide 6 E195–E196
D-Mannose and deriv 8 M16–M17
 D-mannose pentanitrate 8 M17
Manometric stability tests 8 M17
Manonitrometer 8 M17
Manuelites 8 M17
Marble 8 M17
Marin's expls 8 M17
Marine fiber 8 M17
 nitrated marine fiber 8 M17
Marking of ammunition and containers for
 ammunition and expls 8 M18
Marksman powder 8 M18

- Maron and Turnbull (detonation) equation of state 4 D288
- Marqueyrol's stability test 8 M18
- Mass, specific, of constituents of smokeless propnt 8 M18
- Mass spectrometry 8 M19–M39
- , analytical applications 8 M37
 - , combined gas chromatography and mass spectrometry 8 M34–M36
 - , commercial instruments 8 M31
 - , compilations of reference spectra 8 M36
 - , computer techniques 8 M34
 - , definition and terminology 8 M19
 - , elemental composition of ions 8 M31–M32
 - , high resolution technique 8 M33
 - , historical 8 M21–M22
 - , instrumentation 8 M22
 - , ionization sources 8 M22–M29
 - , mass analyzers 8 M29–M31
 - , mass spectra and chemical structure 8 M31
 - , mass spectral studies of expls and related compounds 8 M36
 - , postulation of molecular structures 8 M32–M33
 - , sample introduction system 8 M31
 - , the ionization process 8 M19–M20
 - , uses of the mass spectrum 8 M20
- Masurites 8 M39
- Matagnites 8 M39
- Mataziette 8 M39
- Match 8 M39–M41
- electric matches 8 M41
 - quickmatch 8 M40–M41
 - safety match 8 M39–M40
 - strike anywhere match 8 M40
- Matchlock 8 M41
- Materials handling in ammunition plants 8 M41–M42
- Materials of construction in ammunition plants 8 M42–M44
- Matter expls 8 M45
- Matweed 8 M45
- nitromatweed 8 M45
- Maurette powder 8 M45
- Maxim expl 8 M45
- Maxim, Hiram Steven, Sir 8 M45–M46
- Maxim, Hudson 8 M46
- Maximite 8 M46
- Maxim-Nordenfeldt powder (M.N.) 8 M46
- Maxim powder 8 M46
- Maxim-Schupphaus powder 8 M46–M47
- Maximum available work potential (test) 1 XIX
see Detonation (and expln), work capacity in 4 D730
- Maximum charge 8 M47
- Maximum potential work same as Brisance value of Kast 1 VIII–IX
- Maximum pressure of explosion see Pressure of explosion 1 XX
- Mayer & Careri (detonation) equation of state 4 D289
- Mayevsku, N.U. 8 M47
- Mayrhofer stability test 8 M47
- Mazut or masutt 8 M47
- M.B. powder 8 M47
- MC (poudre) 8 M47
- MC no 3 powder 8 M47
- MC Roberts 8 M47–M48
- MDN see Explosif MDD 6 E361
- MDPC see Explosif MDPC 6 E361
- Meal powder 8 M48
- Measurement of acidity or alkalinity of expls 8 M48
- Measurement of pH value, stability tests by 8 M48
- Mechanical fuze 8 M49
- Mechanical shock (tests) 1 XIX; see Shock sensitivity of explosives 9 S58–S83
- experimental methods 9 S61–S68
 - shock sensitivity data 9 S72–S74
- MEDINA 8 M49–M52
- MEDNA 8 M52–M54

- M₂EDNA** see **N,N'-Dimethyl-N,N'-dinitro-ethylenediamine 5 D1338**
Medium assault weapon (MAW) 7 I96
MeEDNA 8 M54–M55
Meerscheidt-Hullessem stability tests 8 M55
Megadina 8 M55
Meganit 8 M55
Meganites 8 M55
Melamine and derivs 3 C589; 8 M55–M56
 melamine dinitrate 8 M55–M56
 melamine picrate 8 M56
 trinitromelamine 8 M56
Melamina 8 M56
Melanite 8 M56
Melenite 8 M56
Melinite (Fr) 8 M56
Melland powder 8 M56
Melling powder 8 M56
Melsens powder 8 M56
Melting point (mp) 8 M57
Melting point, determination 8 M57–M58
Melville powders 8 M58
Mendeleyev, Dmitry L. 8 M58
Mendoca-Corteso powder 8 M58
MeNENA see **N-(β-Hydroxyethyl) methyl-nitramine 7 H241**
MEP see **5-Ethyl-2-methyl pyridine 6 E313**
5-Mercaptotetrazole 8 M58
 sodium mercaptotetrazole 8 M58
Mercerized cellulose 8 M58
Mercuric acetylide 1 A78
Mercuric-ammonium salts 8 M58
Mercuric azide 1 A590–A591
Mercuric chlorate 2 C190
Mercuric fluoride 6 F144
Mercuric fulminate 6 F217–F223; F226–F230
 and its mixtures, analysis and specification requirements (JAN-M-219) & tests 6 F227–F230
 lab preparation 6 F218–F219
 manufacture in USA of 6 F219–F220
 preparation (general) of 6 F217–F218
 properties of 6 F220–F222
 uses of 6 F222–F223
Mercuric fulminate-sulfur compound 6 F223
Mercuric pyrofulminate 6 F223
Mercurous acetylide 1 A78
Mercurous azide 1 A591–A592
Mercurous chlorate 2 C190
Mercurit 8 M59
Mercury and its salts 8 M59
 mercury fulminate see Fulminates 6 F217
 mercury, fulminating 6 F232
Mercury as masking agent 8 M59
Mercury chlorides 3 C239–C240
Mercury chlorites 3 C245
Mercury oxycyanide 8 M59
Mercury phenyl nitrate 8 M60
Mercury perchlorates 8 M60
Mercury sulfocyanate 8 M60
Merino 8 M60
Mesabi blasting agents 8 M60
Mesa type proplnts 8 M60–M61
Mesitylene and derivs 8 M61–M62
 2-azido-4-nitro-mesitylene 8 M61
 2,4-diazido-mesitylene 8 M62
 2,4-diazido-6-nitro-mesitylene 8 M62
 2,4-dinitro-mesitylene 8 M62
 2-nitro-mesitylene 8 M62
 2,4,6-triazido-mesitylene 8 M62
 2,4,6-trinitro-mesitylene 8 M62
Mesityl oxide 8 M63
Mesityloxydeperoxide 8 M63
Metaldehyde 8 M63

- Metals, compatibility of common expls with
8 M63–M64
- Metalline nitroleum 8 M65
- Metals, expl working of see Expl fabrication of
metals 6 E415
- Meteor Dynamite 8 M65
- Methane and derivs 8 M65–M88
azidomethane 8 M66
azo-halogen derivs of methane 8 M67–M68
azomethane 8 M66–M67
azoxy derivs of methane 8 M68–M69
halogen derivs of trinitromethane
8 M81–M83
halogen dinitro derivs of methane
8 M76–M78
methane, nitroso 8 M85–M86
nitromethane (NMe) 8 M69–M72
nitro halogen derivs of methane 8 M72–M74
nitroso halogen derivs of methane
8 M86–M87
tetranitromethane (TeNMe) 8 M83–M85
trinitromethane (nitroform or TNMe)
8 M78–M81
- Methanites 8 M88
- Methanol 8 M89–M92
, analytical procedures 8 M89–M92
- Methazonic acid and its salts 8 M92
methazonic acid salts, including the
ammonium, lead, mercury, potassium, silver,
sodium, thallium compounds 8 M92
- Methylites 8 M92
- Methods of evaporation of AN solutions (during
manufacture) 1 A314–A318
- Methoxybenzanilide and derivs see
Benzamidoanisole and derivs 2 B39–B40
- Methoxybenzazide same as Anisoylazide 1 A456
- Methoxy naphthalenes and derivs 8 M92–M93
dinitrohydroxy-1-methoxy-naphthalenes
8 M93
2,4-dinitro-5-methoxy-1-acetoxy-naphthalene
8 M93
2-methoxy-1-chloromethyl-naphthalene
8 M93
- Methylabietate 8 M93–M94
methyl dihydroabietate 8 M93–M94
- Methylacardite see Acardite II 1 A8
- 2-Methyl-5-acetamino-benzene-diazonium
hydroxide 1 A22
- Methylacetanilide see Acetamidotoluene and
derivs 1 A22
- Methyl acetate 8 M94
- Methyl acetoacetate 8 M94
- Methyl acetone 8 M94
- Methylacetylene 8 M94
- Methylaluminum diazide 8 M94–M95
- Methylamine and derivs 8 M95–M97
methylamine-5-aminotetrazole salt 8 M95
methylamine azide 8 M95
methylamine complex with cupric azide
8 M95
methylamine cupric bromate complex 8 M95
methylamine cupric chlorate complex 8 M95
methylamine cupric perchlorate complex
8 M95
methylamine hydrobromide cupric azide
8 M96
methylamine MEDINA salt 8 M96
methylamine nitrate 8 M96
methylamine perchlorate 8 M96–M97
methylamine picrate 8 M98
methylamine picronate 8 M97
methylamine salt of 3,6-dinitrophthalic acid
8 M95–M96
methylammonium chloride complex with
cupric azide 8 M97
methylnitramine 8 M97
- Methylaminoguanidine 1 A232
- 2-(N-Methylamino)-5-nitrothiazole 1 A235
- 5-Methylamino- α -tetrazole 1 A234
- N-Methylaniline and derivs 8 M97–M103
nitro derivs of N-methylaniline 8 M99–M102
nitro nitroso derivs of N-methylaniline
8 M102–M103
nitroso derivs of N-methylaniline 8 M103
salts and complexes of N-methylaniline with
inorganic compounds 8 M98
ibid organic compounds 8 M98–M99
- Methyl anisole 8 M103–M105
azido methyl anisole 8 M104
dinitro methyl anisole 8 M104

- Methyl anisole (cont'd)
 methyl nitraminoanisole **8** M104–M105
 mononitro methyl anisole **8** M104
 trinitro methyl anisoles **8** M104
- Methylazaurolic acid **1** A517
- Methyl borate **8** M105
- Methyl CE or methyl tetryl see 2,4,6-Trinitro-3-methylnitramino toluene **5** D1375
- Methyl cyanide same as Acetonitrile **1** A45
- 4-Methyl-2,6-dinitrotetramethylene-2,4,6-triamine **8** M105
- N'-Methyl-N,N-diphenylurea see Acardite II **1** A8
- 1-Methyleneamino-3-nitroguanidine **6** G165
- N-Methylenediamine see Diaminopropane and derivs **5** D1142–D1143
- (Methylenedioxy) dimethanol dinitrate **8** M105
- Methylene ditetryl see Bis (anilino)-propane and derivs **2** B132–B133
- Methyleneglycoldinitrate **8** M105
- N'-Methyl-ethylenedinitramine, N-bromo **8** M105–M106
- Methylethylmethane **2** B366–B367
- Methyl formate **6** F171
- Methyl-d-galactonate pentanitrate **1** A123
- Methyl-d-gluconate pentanitrate **1** A123
- α -Methyl-d-glucopyranoside tetranitrate **6** G84
- Methylglucoside and its tetranitrate **8** M106
 α -methylglucoside tetranitrate **8** M106
- Methyl glycerol **2** B370
- α -Methylglycerol trinitrate see 1,2,3-Butanetriol trinitrate **2** B371
- Methylhydantoin and deriv **8** M106–M107
 1-nitro-5-methylhydantoin **8** M106–M107
- N-Methylhydroxyacetamide and deriv **8** M107
 N-nitro-N-methylhydroxyacetamide nitrate **8** M107
- α -Methyl-D-mannosite **8** M107
 α -methylmannosite tetranitrate **8** M107
- Methylmercuric salts **8** M107–M108
 methylmercuric azide **8** M108
 methylmercuric chromate **8** M108
 methylmercuric nitrate **8** M108
 methylmercuric perchlorate **8** M108
- Methylnaphthalene and its derivs **8** M108–M109
 dinitromethylnaphthalenes **8** M108
 methylido nitronaphthalenes **8** M109
 tetranitro-2-methylnaphthalene **8** M109
 1,6,8-trinitro-2-methylaminonaphthalene **8** M109
 trinitromethylnaphthalenes **8** M109
- Methylnitramine **8** M109–M110
 potassium methylnitramine **8** M110
- 2-(N-Methylnitramino)-thiazoles **1** A235
- 3-Methylnitramino-2,4,6-trinitrophenetole **8** M110
- Methyl nitrate **8** M110–M111
- Methyl nitrite **8** M111–M112
- Methylnitroguanidine and its derivs **8** M112–M113
 N-methyl-N'-nitroguanidine nitrate **8** M112
 N-methyl-N'-nitroguanidine perchlorate **8** M112
 N-methyl-N-nitroso-N'-nitroguanidine **8** M112–M113
- 2-Methyl-2-nitro-1,3-propanediol dinitrate **8** M113
- 2-Methyl-2-nitro-1-propanol and deriv **8** M113
 2-methyl-2-nitro-1-propanol nitrate **8** M113
- Methylnitrosobutyramide **8** M113–M114
- N-Methyl-N'-(2-nitroxyethyl) ethylene dinitramine **5** D1377
- N-Methyl-N-(2-nitroxypropyl) nitramine **8** M114
- 3-Methylol-2-butanol and deriv **8** M114
 3-methylol-2-butanol dinitrate **8** M114
- 3-Methylol-2-butanone and deriv **8** M114
 3-methylol-2-butanone mononitrate **8** M114
- Methyl pentanitrophenyl nitramine **8** M114–M115
- Methylphenol **3** C556

- 2-Methyl-1,3-propanediol and deriv
8 M115–M116
 2-methyl-2-nitro-1,3-propanediol dinitrate
8 M115–M116
- Methyl tetryl or 2,4,6-trinitrotolyl-3-methyl-
 nitramine **8 M116**
- Methyl trimethylolmethane and derivs
8 M116–M117
 methyl trimethylnitramine methane **8 M117**
 methyl trimethylnitramine methane, silver salt
8 M117
 methyl trimethylolmethane trinitrate **8 M117**
- 2-Methyl-2,4,4-trimethylolpentane-1,3,5-triole
 hexanitate **8 M117**
- 2-Methyl-2,3,3-trinitrobutane **8 M117**
- 3-Methyl-2,2,3-trinitro-pentane **8 M118**
- Methyl violet tests **8 M118–M120**
- Metriol and derivs **8 M120–M122**
 metriol triacetate (MTA) **8 M121–M122**
 metriol trinitrate (MTN) **6 E152–E154;**
8 M120–M121
- Mettegang recorder **8 M122**
- M.G.C. **8 M122**
- Mica **8 M122**
- Mica Dynamite **8 M122**
- Michailovsky powder **8 M123**
- Microanalysis of expls **8 M123**
- Microencapsulation **8 M123–M125**
- Micrograin **8 M125**
- Microscopy **8 M125–M130**
 electron microscopy **8 M127**
 optical microscopy **8 M125–M127**
 scanning electron microscopy **8 M127–M128**
 transmission electron microscopy **8 M127**
- Miedziankit **8 M130**
- Mie-Gruneisen and Gruneisen (detonation)
 equation of state **4 D289**
- Mikhailovskic mining expl **8 M130**
- Military biology and biological agents see
 Chemical, biological and radiological (CBR)
 warfare **2 C171**
- Military blasting expls and military demolition
 expls see Demolition expls **3 D56–D61**
- Military blasting gelatines **8 M130–M131**
- Military detonators, igniters, primers, and other
 initiating devices, history of **4 D753**
- Military igniters, lighters and firing devices
4 D768
- Military specification **8 M131**
- Military specification for NG for use in propnlts
6 G104–G106
- Military standard **8 M131**
- Millbank expls **8 M131**
- Miller expl **8 M131**
- Mills grenade **8 M131**
- Mindeleff expl **8 M131**
- Mines (military) **8 M131–M133**
 aerial mines **8 M132**
 land mines **8 M132**
 Naval mines **8 M132**
- Mine clearing equipment **8 M133**
- Mine detector **8 M133**
- Mine, poudres de **8 M133**
- Minelites **8 M133–M134**
- Mineral acid esters as gelatinizers for NC **8 M134**
- Minerite **8 M134**
- Miner's friend **8 M134**
- Miner's safety expl **8 M134**
- Miner's squib **8 M134–M135**
- Minex **8 M135**
- Miniature-cartridge test **1 XVIII; 8 M135**
- Miniature charge techniques for determination of
 detonation velocity **1 XIX**
- Miniature conductive mix detonator **8 M135**
- Mining expls see Blasting expls **2 B202–B212;**
 Commercial or industrial expls **3 C434–C460**
- Minite **8 M135**

- Minol **8** M135–M143
 , analytical **8** M139
 , properties **8** M139–M140 (table 1)
 , uses **8** M139
- Minolite antigrisouteuse **8** M143
- Minolites **8** M143
- Minuteman **8** M143–M144
- MIRV **8** M144
- Miscellaneous ammunition **1** A384
- Mischdynamit **8** M144
- Misch metal **8** M144
- Missile (guided, non-ballistic) **8** M144–M145
- Missiles and rockets, guided **4** D836
- Mist and spray explns see FAE & FAX **6** F3–F4
- Mittasch stability test for NC **8** M145–M146
- Mity mite see Dispenser M106 **5** D1506
- MNBAC see Mononitrobenzoic acid **2** B71
- MJ powder **8** M146
- M.N. **8** M146
- MNAns same as Mononitroanisoles **1** A448
- MNB see Mononitrobenzene **2** B45–B46
- MNO **8** M146
- Moddite **8** M146
- Model designations **8** M146–M147
- Modernization engineering project for US Army
 ammunition plants **8** M147–M148
- Modified TNT **8** M148
- Mohaupt effect **8** M148
- Moisson no **8** M148
- Moisture **8** M149–M154
 effect of moisture on expls **8** M149–M150
 effect of moisture on proplnts **8** M150
 effect of moisture on pyrots **8** M150–M151
 moisture, analytical procedures
8 M151–M152
- Molasses **8** M154
 nitrated molasses **8** M154
- Molex expls **8** M154
- Molybdenum fluoride **6** F144
- Monacetin **1** A31
- Monachit **8** M154
- Monakay expl **8** M154
- Monoacyl glycerol nitrates **8** M155
- Monobels **1** A1; **8** M155
- 5- and 6-Monochloro-benzotriazol-1-ol
2 B87–B88
- Mono-, di- and trinitro-benzotoluides **2** B86
- Monohalogen derivs of cumene **3** C574
- Monolithium hydroacetylde **1** A77
- Mononitraminoacetophenones **1** A178–A179
- Mononitraminoaminotriazole **5** D1149
- Mononitroabietic acid **1** A3
- Mononitroacetaldoxime **1** A16
- Mononitroacetamide **1** A16
- Mononitroacetamido anisole **1** A17
- Mononitroacetamidodiphenylether **1** A18
- Mononitroacetamidonaphthalenes **1** A20
- Mononitroacetamidophenetole **1** A20
- Mononitroacetamidophenol **1** A21
- Mononitroacetamidotoluenes **1** A22
- Mononitroacetanilides **1** A23
- (6-Mononitro-5-acetic acid)-benzotriazol-1-ol
2 B88
- Mononitroacetoneitrile **1** A45
- Mononitroacetophenones **1** A48
- Mononitroacetophenoneoximes **1** A49
- Mononitroacetoxime **1** A51
- Mononitroacetyldiphenylamine **1** A58
- Mononitroacetylphenylhydrazine **1** A86
- Mononitroacetylpyrrole **1** A86
- Mononitroacetylsalicylic acid **1** A87
- Mononitroacridine **1** A94
- Mononitroacridone **1** A96

- Mononitroaminoanisoles 1 A182
Mononitroaminoanthraquinones 1 A183
Mononitroaminoazobenzenes 1 A185
Mononitroaminobenzaldehydes 1 A186
Mononitroaminobenzoic acids 1 A189
Mononitroaminobiphenyls 1 A191
Mononitroaminocarbazoles 1 A193
Mononitroaminocresols 1 A194
Mononitroaminodiphenylamines 1 A196–A197
Mononitroaminodiphenyleneoxides 1 A198
Mononitroaminodiphenylethers 1 A198–A199
Mononitroaminomethylbiphenyls 1 A229
Mononitroaminomethyldiphenylamines 1 A230
Mononitroaminophenetoles 1 A240
Mononitroaminopyridines 1 A254
Mononitroaminoresorcinols 1 A256
Mononitroaminotoluenes 1 A265
Mononitroanilines 1 A407–A408
Mononitroanilinoacetic acid 1 A420
Mononitroanilinoazobenzene 1 A420
Mononitroanilinobenzoic acid 1 A422
Mononitroanilinophenols 1 A433
Mononitroanilinopropanols 1 A436
Mononitroanilinopropionic acids 1 A436
Mononitroanilinotoluenes; nitrodiphenyl-
methylamines 1 A438
Mononitroanilinoxylenes 1 A443
Mononitroanisaldehydes 1 A444
Mononitroanistic acids 1 A446
Mononitroanisoles (MNAns) 1 A448
Mononitroanisylalcohols 1 A456
Mononitroanthracenes 1 A458
Mononitroanthramines 1 A459
Mononitroantipyrenes 1 A471
Mononitroapigenins 1 A473
Mononitrobenzaldehyde 2 B35
Mononitrobenzaldehydeazines 2 B36
Mononitrobenzaldehyde-(2,4-dinitrophenyl-
hydrazone) 2 B37
Mononitrobenzaldehydenitrophenylhydrazone
2 B37
Mononitrobenzaldehydeoximes 2 B36
Mononitrobenzaldehyde-phenylhydrazone 2 B37
Mononitrobenzaldehyde-semicarbazones 2 B38
Mononitrobenzaldehyde-(2,4,6-trinitrophenyl-
hydrazone) 2 B38
Mononitrobenzamide 2 B39
Mononitrobenzamido-anisoles 2 B39
Mononitrobenzamidophenol 2 B40
Mononitrobenzanilide 2 B40
Mononitrobenzeneazonaphthalene 2 B53
Mononitrobenzeneazonaphthol 2 B53–B54
Mononitrobenzeneazonitronaphthol 2 B54
Mononitrobenzenediazo-oxide 2 B58–B59
Mononitrobenzenesulfenamides 2 B60
Mononitrobenzenesulfonylchlorides 2 B61
Mononitrobenzenesulfinic acids 2 B61
Mononitrobenzenesulfonic acid 2 B62
Mononitrobenzenethiol 2 B63
Mononitrobenzidine 2 B64
Mononitrobenzil 2 B64
Mononitrobenzimidazole 2 B65
Mononitrobenzimidazolone 2 B65
Mononitrobenzocarbazole 2 B66
Mononitrobenzodioxan 2 B66–B67
Mononitrobenzofuran 2 B67
Mononitrobenzofurazan 2 B68
Mononitrobenzofuroxan 2 B68
Mononitrobenzohydroxamic acid 2 B69

- Mononitrobenzotrifluoride 2 B89
Mononitrobenzoylchlorides 2 B90
Mononitrobenzyl 2 B110
Mononitrobenzyl alcohol 2 B91
Mononitrobenzylamine 2 B93
Mononitrobenzylazide 2 B94
Mononitrobenzylchloride 2 B95
Mononitrobenzylcyanide 2 B96
Mononitrobenzyl dinitrobenzoate 2 B95
Mononitrobenzyl-dinitrophenylether 2 B99
Mononitrobenzylideneaminophenol 2 B97
Mononitrobenzylideneaniline 2 B97
Mononitrobenzylmalonic acid 2 B98
Mononitrobenzyl-mononitrobenzoate 2 B95
Mononitrobenzyl-mononitrophenylether 2 B99
Mononitrobenzylphenylether 2 B99
Mononitrobenzylpyridine 2 B100
Mononitrobenzyltoluidine 2 B100
Mononitrobicresol 2 B112
Mononitrobiphenyl 2 B123
Mononitrobiphenylcarboxylic acid 2 B125
Mononitrobiphenyldicarboxylic acid,
2 B125–B126
Mononitrobromoaniline 2 B307
Mononitrobromoazobenzene 2 B308
Mononitrobromoazoxybenzene 2 B308
Mononitrobromobenzene 2 B309
Mononitrobromobenzohydroxytriazole 2 B310
Mononitrobromomethane 2 B312
Mononitrobromomethylaniline 2 B313
Mononitrobromophenol 2 B315
Mononitrobromoresorcinol 2 B316
Mononitrobutane 2 B367
Mononitrobutanol 2 B373–B374
Mononitrobutanone 2 B375
Mononitrobutene 2 B375
Mononitro-C-butylaniline 2 B378
Mononitro-N-butylaniline 2 B378
Mononitrobutylbenzamide 2 B380
Mononitrobutylbenzene 2 B380
Mononitrobutylguanidine 2 B384
Mononitrobutyltoluene 2 B388
Mononitrobutylurethane 2 B389
Mononitrobutyric acid 2 B392
Mononitrobutyronitrile 2 B393
Mononitrobutyrophenone 2 B393–B394
Mononitrocamphor 2 C23
X-Mononitrocaprylene 2 C39–C40
Mononitrocarbamic acid 2 C40
Mononitrocarbanilide 2 C44
Mononitrocarboxyhydrocinnamic acid 2 C65
Mononitrochalcones 2 C246
Mononitrochloroanilines 3 C247
Mononitrochloroanisole 3 C248
Mononitrochlorobenzene 3 C249
Mononitrochlorobenzonitrile 3 C252
Mononitrochloroethane 3 C254
Mononitrochlorohydroxyanisole 3 C257
Mononitrochlorohydroxybenzaldehyde-(4-
nitrophenylhydrazone) 3 C257
Mononitrochloromethane 3 C259
Mononitrochloromethylaniline 3 C260

- Mononitrochlorophenol **3** C262
Mononitrochloropropane **3** C264
Mononitrochloropropanediol **3** C266–C267
Mononitrochloropyridine **3** C267
Mononitrochlorostyrene **3** C268–C269
Mononitrochloroxylene **3** C273
Mononitrochrysene **3** C320
Mononitrochrysenedione **3** C321
Mononitrocinnamic acid **3** C323
Mononitrocoumaranone **3** C548
Mononitrocoumaric acid **3** C549
Mononitrocoumarilic acid **3** C549
Mononitrocresols **5** C556
Mononitrocumene **3** C573–C574
C-Mononitro-m-cresol-sulfonate **3** C558
Mononitrocyclohexane **3** C595
Mononitrocyclohexyltoluidine **3** C601
Mononitroderivs (& salts) of dihydroxybenzene
5 D1271–D1273
Mononitrodesoxyinositols **3** D91
Mononitrodiacetin **1** A33
Mononitrodiaminoanisole **5** D1127
Mononitrodiaminoazobenzenes **5** D1128–D1129
Mononitrodiaminobenzenes **5** D1129–D1130
Mononitrodiaminodimethylbenzenes **5** D1136
Mononitrodiaminophenol **5** D1141–D1142
Mononitrodiaminopropane **5** D1142
Mononitrodiaminotetramethylbenzenes **5** D1144
Mononitrodiaminotoluenes **5** D1146
Mononitrodiazoaminobenzenes **5** D1156
Mononitrodiazobromobenzoquinone **2** B310
Mononitro-diazo-butyrophenone **2** B394
Mononitrodiazochlorophenol **3** C262
Mononitrodiazodiphenylamine **5** D1163
Mononitrodiazonaphthalene **5** D1168
Mononitrodiazonaphthol **5** D1168–D1169
Mononitrodiazotoluene salts **5** D1178
Mononitrodiazotoluene sulfonic acids **5** D1179
Mononitrodiazoxylenesulfonic acids **5** D1182
Mononitrodibromobenzene **5** D1191
Mononitrodibromophenol **5** D1194
Mononitrodichloroazobenzenes **5** D1204
Mononitrodichloroazoxybenzene **5** D1205
Mononitrodiethylbenzene **5** D1228
Mononitrodiethylether **5** D1235
Mononitrodifluorobenzenes **5** D1258
Mononitrodihydroxytoluene **5** D1296
Mononitrodimethoxyanilines **5** D1301
Mononitrodimethoxybenzene **5** D1302
Mononitrodimethoxytoluenes **5** D1305
Mononitrodimethylaminobenzaldehydes
5 D1307
Mononitro-N,N-dimethylanilines **5** D1315
Mononitrodimethylanisole **5** D1319
Mononitrodimethylbenzaldehydes
5 D1320–D1321
Mononitrodimethylbenzene **5** D1321–D1322
Mononitrodimethylbenzoic acids
5 D1326–D1327
Mononitrodimethylindazole **5** D1347
Mononitrodiphenylamines **5** D1427–D1430
Mononitrodiphenyldisulfide **5** D1450
Mononitrodiphenylethers **5** D1452
Mononitrodiphenylethylene **5** D1454
Mononitro- α,α' -diphenylethylene ether
5 D1457–D1458
Mononitrodiphenylformamidine
5 D1459–D1460
Mononitrodiphenylmethane **5** D1465
Mononitrodiphenylmethanol **5** D1467
Mononitrodiphenylquinomethane **5** D1475

- Mononitrodiphenylsulfides 5 D1476
 Mononitrodiphenylsulfones 5 D1479
 Mononitrodiphenyltetrazoles 5 D1481–D1482
 Mononitrodiphenylthioureas 5 D1484
 Mononitrodiphenylurethane 5 D1487
 Mononitro-N,N-dipropylaniline 5 D1494
 Mononitroethylglycol ether 6 E297
 Mononitrofluoranthenes 6 F120
 Mononitrofluorenes 6 F122
 Mononitrofluorenes 6 F123
 Mononitroguaiacols 6 G147
 Mononitrohippuric acids 7 H113
 Mononitrohippuric acid azide 7 H113–H114
 Mononitrohydrazinotoluene 7 H210
 Mononitrohydroxybenzene 7 H232–H233
 Mononitrohydroxybenzenearsonic acid 7 H234
 Mononitrohydroxybenzeneazonaphthol 7 H235
 Mononitrohydroxybenzophenyltriazole 2 B79
 Mononitro-hydroxyquinolines 7 H249
 Mononitroiodobenzene 7 I121
 Mononitro-iso-butane 2 B368
 Mononitroisodiazotoluenes and their salts 5 D1178
 Mononitro-N-nitrosobromethylaniline 2 B313
 Mononitro-N-nitrosochloromethylaniline 3 C260
 Mononitronitrosochloropropane 3 C264–C265
 Mononitrophenyl-phenyl-triazoles 5 D1486
 Mononitrosobenzyl alcohol 2 B91
 Mononitroso-3,5-diamino- α -s-triazole 5 D1148
 Mononitroso-dimethylbenzene 5 D1321
 Mono-oil 8 M155
 Monopropnt 8 M155–M156
 Monorubidium acetylide 1 A79
 Montan wax 8 M156
 Montravel 8 M156
 Moorite propnt 8 M156
 Morse's powder 8 M156
 Mortar 2 C27–C28
 Mortar, ballistic see Ballistic mortar test 2 B6
 Mortar projectile fuzes 4 D922
 Mortars 8 M156–M157
 Mortar test 1 XIX see Ballistic mortar test 2 B6
 Mortier and Sandon 8 M157
 Moss 8 M157
 Motorite 8 M157
 Motors activated by expls 8 M157
 Mowbray, G.M. 8 M157
 MOX expls 8 M157–M159
 MSX same as 1-Acetoxy-2,4,6-trinitro-2,4,6-triazaheptane 1 A53
 MSX see 1-Ethoxy-2,4,6-trinitro-2,4,6-triazoheptane 6 E195
 MS-80 blasting agent 8 M160
 MT see Mechanical time artillery fuzes 4 D906
 MtrT see Ethane-1,1,1-tris (hydroxymethyl) trinitrate 6 E152–E153
 MTTC 8 M160
 MTSQ see Mechanical time superquick artillery fuzes 4 D906
 MTX 8 M160
 Mucic acid and derivs 8 M160
 diazomucic acid 8 M160
 mucic acid trinitrate 8 M160
 silver mucic acid diamide 8 M160
 Mudcapping 8 M160
 Mullerites 8 M160–M161
 Multiperforated propnt grains see Cannon . . . powder 2 C30–C31; also Grains of . . . propnts 6 G123
 Munroe, Charles Edward 8 M161
 Munroe-Neumann effect test see Shaped charge efficiency test 1 XXIII
 Muraour, Henri 8 M161–M162

M12

Murgai (detonation) equation of state 4 D290

Murtineddu powder 8 M162

Mustard gas 8 M162

Muzzle 8 M162

Muzzle brake 8 M162

Muzzle flash 8 M162

Muzzle velocity 2 B7-B8; 8 M162-M163

MV see Muzzle velocity 2 B7-B8; 8 M162-M163

MVT 8 M163

Myrite 8 M163

Myrobalan 8 M163

Myrobalan expl 8 M163

Myrol 8 M163-M164

Myrol expl 8 M164

N1**N**

- N¹⁵, reactions with **8 N1**
N57 **8 N1**
NAC same as Nitroacetylcellulose **1 A56**
NACO **8 N1**
"N" (Fr expl) **8 N1**
Nahsen Dynamites **8 N1**
Nahsen expls **8 N1**
Nail test **1 XIX; 8 N1**
NAm Gu same as 1-Nitro-3n-amylguanidine
1 A396
Nansenit **8 N1**
Naoum Phokion **8 N1-N2**
Napalm **8 N2-N3**
Naphthas **8 N3**
Naphthas, hydroformed **8 N3-N4**
 nitrated hydroformed naphthas **8 N4**
 nitrated solvent naphtha **8 N4**
 solvent naphtha **8 N4**
Naphthalene and derivs **8 N4-N16**
 azidonaphthalenes **8 N5**
 azo derivs of naphthalene **8 N6-N7**
 nitro derivs of naphthalene **8 N7-N16**
Naphthalit **8 N16**
Naphthalites **8 N16**
Naphthol and derivs **8 N17-N21**
 benzeneazonaphthol **2 B53**
 benzeneazonitronaphthol **2 B54**
 dihydroxynaphthalene and derivs
 5 D1294-D1295; 8 N20-N21
 dinitrocompds of naphthols **8 N18-N19**
 mononitrocompds of naphthols **8 N17**
 1-naphthol additive compds **8 N17**
 2-naphthol additive compds **8 N17**
 naphthols **8 N20**
 other derivs of the mononitrocompds of
 naphthols **8 N19**
 peroxides of naphthols **8 N20**
 tetranitro-1-naphthols **8 N20**
 trinitro-2-naphthols **8 N20**
Naphthylamines see Aminonaphthalenes
 1 A237-A238
Naphtite **8 N16**
Naphtites **8 N16-N17**
Nationalite **8 N21**
National Technical Information Service (NTIS)
 6 G121-G122
National Transportation Safety Board **8 N21**
Natrialmatrit no 19 see Almatrites **1 A140**
Natural barricade see Barricades in expls and
 ammunition installations **2 B22**
Natural gas **6 G27; 8 N21-N22**
Nauchoff's expls **8 N22**
Naval mines **8 N22**
Navez chronograph **3 C305**
Navol tank, torpedo **8 N22**
5-NATZ same as 5-Nitraminotetrazole
 1 A259-A260; 9 T116-T117
NBSX same as 1,7-Dinitroxy-1,3,5,7-tetra-
 methylene-2,4,6-triamine **5 D1295-D1296**
NC see Cellulose nitrates **2 C100-C125; 8 N22**
Nebelwerfer **8 N22**
Neck **8 N22**
Needle gun **8 N22-N23**
Needle point projectiles same as Arrowhead
 projectiles **1 A489**
Neesen's photogrammetric apparatus **8 N23**
Negro **8 N23**
Negro powder no 2 **8 N23**
Nellite **8 N23**
NENA or 1-nitramino-2-ethanol nitrate
 1 A201, A253; 6 E342
NENO see N,N'-Dinitro-N,N'-di (2-ethylol)-
 oxamide dinitrate **5 D1244-D1245; 8 N23**
Neo (poudres) **8 N23**

- Neobar see Barium sulfate 9 S234
- Neonals 8 N23
- Neonite 8 N23–N24
- NEP see 2-Nitro-2-ethyl-1,3-propanediol 6 E325
- Neopentryl 8 N24
- Neptune powder 8 N24
- NEt see Nitroethylene 6 E229
- NEtPol see Nitroethylene polymer 6 E229–E230
- Neu-Babelsberg calorimeter 8 N24
- Neodynamits 8 N24
- Neugen 8 N24
- Neumann, Egon 8 N24
- Neumann's classical theory of the plane
detonation wave 4 D237
- Neu-Nobelit 8 N24
- Neutral proplnt grain 8 N24
- Neutron kill 8 N24–N25
- Neuwestfalit 8 N25
- New Explosive Co, Ltd 8 N25
- New Fortex 6 F174
- Newit 8 N25
- Newton powder 8 N25
- NG see Nitroglycerin 5 D1593–D1594
- NGc see Nitroglycol 5 D1594
- NGk 8 N25
- NG, tests not required by military specification
MIL-N-246B 6 G106–G108
- NGu 8 N25
- NGX 8 N25
- N-HMX 8 N25
- N.H. powders 8 N25
- Nib 8 N25
- NIBGTN 8 N25
- NIBTN see Nitro-iso-butanetriol trinitrate
2 B371-B372
- Nickel 8 N25–N26
- Nickel acetylide 1 A78
- Nickel (II) ammine complexes 1 A275 ff
- Nickel carbide 1 A78
- Nickel carbonyl 8 N26
- Nickel chlorate 2 C190
- Nickel chlorite 3 C245–C246
- Nickel diazide 1 A592–A593
- Nickel fluoride 6 F144
- Nickel-hydrazine nitrate complex 8 N26
- Nico powder 8 N26–N27
- Niepce's incendiary composition 8 N27
- Nightingale and Pearson powder 8 N27
- Nigrosine 8 N27
- Nike 8 N27
- Nikles 8 N27
- Nilite 8 N27
- Niperit 8 N27
- Nipolit 8 N27–N28
- Nisser powders 8 N28
- Nital 8 N28
- Niter 8 N28
- Niter cake see Bisulfate, sodium 2 B162–B163
- Nitetra (Fr) 8 N28
- Nitramex 8 N28
- Nitramides 8 N28–N29
- Nitramidon 8 N29
- Nitramin 8 N29
- Nitramines 8 N29
- Nitraminoacetic acid 1 A178
- Nitraminoalcohols 1 A179
- Nitraminoanthraquinones 1 A183
- Nitraminobenzaldehyde 1 A186
- Nitraminobenzenes 1 A185

- 2-Nitramino-1-butanol nitrate 1 A192–A193
 Nitraminoethane 1 A199
 1-Nitramine-2-ethanol nitrate (NENA) 1 A201
 1-Nitramino-2-ethanol 1 A200
 1-Nitramino-2-ethanol nitrate or NENA 1 A201
 N-(2-Nitraminoethyl)-acetamide 6 E202
 1- β -Nitraminoethyl-1-nitroso-2-nitroguanidine 1 A205
 3-(2-Nitraminoethyl)-1-nitrourea 1 A209
 N-(β -Nitraminoethyl)-N-propyl-N'-nitro-urea 1 A206
 N-(β -Nitraminoethyl)-N'-propyl-urea 1 A206
 Nitraminoguanidine (NAGu) 1 A210–A212
 Nitraminoimidazoles see Aminoimidazoles 1 A218
 2-Nitramino- Δ^2 -imidazoline 1 A219
 2-Nitraminoimidazoline-2 6 E280
 2-Nitramino-2-imidazolinol 1 A222
 1-[2-(2-Nitramino- Δ^2 -imidazolin-1-yl) ethyl]-3-nitroguanidine 1 A222
 1'-[β -(2-Nitramino- Δ^2 -imidazolin-1-yl) ethyl]-3'-nitro-1'-nitrosoguanidine 1 A222
 Nitraminomethane 1 A227
 2-Nitramino-4-methyl-5-nitrothiazole 1 A235
 2-Nitramino-2-methyl-1-propanol nitrate 1 A233
 Nitraminomethyltriazoles 1 A236–A237
 2-Nitramino-5-nitrothiazole 1 A263
 Nitraminopicolines 1 A249
 3-Nitraminopicolinic acid 1 A249–A250
 Nitraminopropanes 1 A250
 3-Nitraminopropanoic acid 1 A252–A253
 Nitraminopropanol nitrate or Iso-Me-NENA 1 A253
 Nitraminoquinolines 1 A256
 5-Nitraminotetrazole (5-NATZ) 1 A259–A260; 9 T116–T117
 2-Nitramino-1,3,4-thiadiazole 1 A263
 Nitraminotoluenes 1 A265
 6-Nitramino-s-triazine-2,4-diol see Amelide and derivs 1 A273
 3-Nitramino- α -sym-triazole 1 A269–A270
 5-Nitraminotetrazole of Lieber and its salts 1 A260
 5-Nitraminotetrazole of O'Connor and its disodium salt 1 A259
 2-Nitramino-3,4,5-trinitrothiazolone 1 A263–A264; 9 T218
 Nitraminoxylenes 1 A272
 Nitramita de la fabrica de galdacano (Span) see Coal mining expls, permissible 3 C455
 Nitramita espanola de la fabrica de granada see Coal mining expls, non-permissible 3 C442
 Nitramite 8 N29–N30
 Nitramon 8 N30
 Nitranaftita 8 N30
 Nitranilic acid see 3,6-Dinitro-2,5-dihydroxy-1,4-benzaquinone 5 D1290
 Nitranthraquinones 1 A460
 Nitrasols 8 N30–N32
 Nitrate & nitrite derivs of dichlorohydrin 5 D1212
 Nitrate compounds 8 N32–N40
 ammonium nitrate 1 A311–A340; 8 N32
 Ba nitrate 2 B20–B21; 8 N32
 Ca nitrate 8 N32–N33
 cellulose benzoate nitrates 2 C99
 cellulose nitrate 2 C100–C126
 Ce ammonium nitrate 8 N33
 ethyl nitrate 8 N33
 lead nitrate 8 N33
 Li nitrate 8 N33
 Mg nitrate 8 N33–N34
 mercuric nitrate 8 N34
 mercurous nitrate 8 N34
 potassium nitrate 8 N34–N36
 sodium nitrate 8 N36–N37
 Sr nitrate 8 N38–N39
 tin nitrate 8 N39
 U nitrate 8 N39–N40
 Zn nitrate 8 N40
 Zr nitrate 8 N40

- Nitrated aliphatic hydrocarbons **1** A127
- Nitrated compounds of carbazole **2** C49–C50
- Nitrated derivs of aniline **1** A407
- Nitrated linen fiber **7** L18
- Nitrated marine fiber **8** M17
- Nitrated molasses **8** M154
- Nitration **8** N40–N88
 history of nitration and nitrated compounds,
 early **8** N41–N42
 nitrating agents **8** N44–N45
 nitration, introduction **8** N40–N41
 nitration mechanism **8** N75–N80
 nitration, recent literature on **8** N80–N83
 nitration, spent acid **8** N45–N48
 nitrations, safety in **8** N83–N86
 nitration, technology of (NC, Nitromethane,
 Tetryl; TNT) **8** N48–N72
 nitration, thermochemistry of **8** N72–N74
 nitration, typical expls produced by
8 N42–N44
- Nitrato **8** N88
- Nitratodimercuriacetaldehyde **8** N88
- 2-Nitratoethylacrylate **6** E202
- N-(2-Nitratoethyl)-N, 2,4,6-tetranitroaniline
1 A425
- 9-Nitratofluorene **6** F122
- Nitratophosphites **8** N88–N89
 lead nitratophosphate (LNP) **8** N88
 mercurous nitratophosphate **8** N88–N89
- Nitratotrimercuriacetaldehyde **8** N88
- Nitre **8** N89
- Nitrylthrite (Fr) see Erythritol tetranitrate
5 E124–E125
- Nitric acid **8** N89–N99
 nitric acid, manufacturing processes for
8 N90–N93
 nitric acid, properties of **8** N93–N97
- Nitric ether see Ethane nitrate **6** E143
- Nitrides **8** N99–N103
 antimony nitride **8** N99
 Bi nitride **8** N99
 Br nitride **8** N99
- Nitrides (cont'd)
 Cd nitride **8** N99
 Ce nitride **8** N99
 Cl nitride **8** N99–N100
 Cu nitride **8** N100
 fluorine nitride **8** N100
 I nitrides **8** N100–N101
 mercury nitride **8** N101
 potassium nitride **8** N101
 Se nitride **8** N101
 silver nitride **8** N102
 sodium nitride **8** N102
 sulfur nitride **8** N102–N103
 Te nitride **8** N103
 thallium nitride **8** N103
- Nitriles **8** N103–N105
 acetonitrile and derivs **1** A45–A46
 acrylonitrile and derivs **1** A97–A98
 nitriles, analytical tests for **8** N104
 benzonitrile and derivs **2** B76–B77
 cyanamide and derivs **3** C580–C582
 cyanocompounds **3** C583–C591
 diazoacetonitrile **8** N104
 1,2-dicyanoethane **8** N104
 dicyanomethane **8** N104
 isonitriles **8** N104–N105
 nitrile oxides **8** N105
 nitrilotriacetic azide **8** N104
 triacetonitrile oxide **8** N105
 tribenzonitrile **8** N105
 trifulmin **8** N105
- Nitrilotrinitroethanol **6** E183
- Nitrilotrinitroethanol nitrate **6** E183–E184
- Nitrilotrinitroethanol phosphate **6** E184
- Nitrimines **8** N105–N106
- Nitrimines, listing **8** N106–N107
 dicyandiamine & derivs **5** D1217–D1218
 hexanitrodiphenylguanidine **8** N106
 nitroguanidine and derivs **6** G154 ff
 3-nitro-5-imino-1-benzoylcyclopentene-1
8 N106
 α' -nitro- α -iminodibenzylcarbonic acid-2
8 N106
 [N-nitro-iminodiacetic acid]-bis-[2,4-dinitro
 anilide] **8** N106
 nitroiminodiacetic acid and expl salts
8 N106–N107
 nitroiminodiacetic acid diamide **8** N107

Nitrimines, listing (cont'd)

- nitroiminodiacetic acid dinitrile **8 N107**
- N-nitro-[alpha, alpha-imino dipropionic acid] **8 N107**
- N-nitro-alpha, alpha-imino dipropionic acid **8 N107**
- pinacoline nitraminic acid and expl silver salt **8 N107**

2-Nitriminoethyleneguanidine **6 E280**

- 1'-[beta-(2-Nitrimino-3-nitro- Δ^2 -imidazolin-1-yl-ethyl)]-1',3'-dinitroguanidine **1 A222**

Nitrites **8 N107**Nitrites, listing **8 N108**

- ammonium nitrite **1 A380; 8 N108**
- amyl nitrite **1 A397**
- Ba nitrite **8 N108**
- Cu diamminonitriles see Ammines **1 A275 ff**
- ethyl nitrite see Ethane nitrite **6 E145**
- hydrazine nitrite **7 H196**
- potassium nitrite **8 N108**
- sodium nitrite **8 N108**

Nitrito-compounds **8 N108**Nitritodimercuriacetaldehyde **8 N109**Nitroacenaphthenes **1 A12-A13**Nitroacetaldehydes **1 A15**Nitroacetaldoxime, anhydride **1 A16**Nitroacetaldoxime see Methazonic acid **1 A16**Nitroacetic acid **1 A27; 8 N109**Nitroacetin see Dinitroacetin **1 A33; 8 N109**Nitroacetonitrile see Acetonitrile . . . **1 A45**Nitroacetyl chloride **1 A57**Nitroacid **8 N109**3-Nitroacrylamide **1 A96**3-Nitroacrylic acid **1 A97**3-Nitroacrylonitrile **1 A98**Nitroagave see Agave **1 A110**Nitroalbuminoids **8 N109**Nitroalkanols **8 N109**3-Nitro-3-amino-azoxybenzene **1 A186**Nitroamino compounds **8 N109**Nitroaminoguanidine **1 A210**Nitroaminoguanidine (NAGu) salts
1 A212-A213Nitroaminohydroxybenzoic acids **1 A217-A218**1-Nitro-2-aminoimidazoline-2 **6 E281**4-Nitro-2-aminomesitylene **1 A225**Nitroaminonaphthalenes **1 A237**1-Nitro-2-amino-2-nitraminoimidazole **6 E281**1-Nitro-2-amino-2-nitraminoimidazolidine
1 A219Nitroaminophenylarsonic acid **1 A245**Nitroaminophenylphosphonic acids **1 A246**Nitroaminopicolines **1 A249**Nitroaminosalicylic acids **1 A257**5-Nitro-2-amino-1,3,4-thiadiazole **1 A262-A263**Nitroaminoxylenes **1 A272**Nitroammelide **1 A273**Nitroamyleneglycol dinitrate **8 N110**1-Nitro-3n-amylguanidine (NAmGu) **1 A396**Nitro and nitroso derivs of dichlorobenzene
5 D1207-D1208Nitro- and nitroso derivs of diethylaniline
5 D1226-D1227Nitro- and nitroso derivs of di-(cyclohexyl)-
ethylene-diamine **5 D1219-D1220**Nitro- and nitroso derivs of piperazine **5 D1231**Nitro and other derivs of benzoic acid
2 B71-B75Nitroanhydroformaldehydeaniline **1 A404**Nitroanilines see Aniline **1 A406**Nitroanilinobenzonitrile **1 A422**5-Nitroanilino- α -(or 1H)-tetrazole **1 A437**Nitroanisaldehyde-dinitro-phenylhydrazones
1 A4453-Nitro-(p-anisaldehyde)-(4'-nitrophenylhydra-
zone) **1 A445**Nitroanisole see Anisole . . . **1 A448 ff**

- Nitroantipyrene nitrates 1 A472
 Nitroantipyrene picrates 1 A472
 Nitroarabinose see Arabinose 1 A476
 6-Nitro-4-azido-2-aminomesitylene 1 A225
 Nitroazidoanthraquinone 1 A460
 Nitrobaronit 8 N110
 Nitrobellite see Bellite 2 B32
 Nitrobenzaldehyde see Benzaldehyde 2 B35
 Nitrobenzaldehyde oxime-4-diazonium chlorides 2 B36
 3-Nitrobenzaldehyde-phenylhydrazone peroxide 2 B38
 Nitrobenzamidine picrates 2 B39
 Nitrobenzamidines 2 B39
 Nitrobenzamido-dinitroanisoles 2 B39
 Nitrobenzamido-nitroanisoles 2 B39
 Nitrobenzamido-trinitroanisoles 2 B39–B40
 Nitrobenzdinitroanilides 2 B40
 Nitrobenzene see Benzene . . . 2 B41 ff
 p-Nitrobenzeneazotrinitromethane 2 B53
 m-Nitrobenzenediazonium perchlorate 8 N110–N111
 Nitrobenzene Dynamite 8 N111
 Nitrobenzenes 2 B45–B52
 trinitrobenzene 2 B47–B50; 9 T375–T378
 Nitrobenzoic acid see Benzoic acid . . . 2 B69 ff
 Nitrobenzoic Dynamite 8 N111
 Nitrobenzol 8 N111
 Nitrobenzonitroanilides 2 B40
 6-Nitrobenzo-4-oxy-vic-triazine 2 B87
 Nitrobenzoyl 8 N111
 3-Nitrobenzoyl nitrate 2 B90
 Nitrobenzyl 8 N111
 o-Nitrobenzyl chloride 8 N111
 Nitrobenzyl dinitrate 2 B91–B92
 1-(4'-Nitrobenzyl)-3,5-dinitro-sym-triazole 2 B101
 p-Nitrobenzylmalonazidic acid 2 B98
 Nitrobenzyl nitramine 2 B93
 Nitrobenzyl nitrate 2 B91
 4-Nitrobenzyl-2,4,6-trinitrophenyl ether 2 B99
 2-Nitrobiphenyl-bis-(4,4'-diazoniumhydroxide) 2 B125
 Nitro-bis-benzenediazonium perchlorate 8 N111
 1-Nitrobiuret 2 B164
 Nitrobran see Bran 2 B260
 4-Nitro-5-bromo-2-diazoescorcinol-1-methyl ether 5 D1174
 1-Nitro-1-bromoethane 2 B311
 2-Nitro-2-bromoethanol 2 B312
 2-Nitro-2-bromoethylnitrate 2 B311–B312
 Nitrobromoform 2 B312
 Nitrobutane see n-Butane . . . 2 B366 ff
 Nitrobutanol nitrate 2 B373; 8 N111–N112
 Nitrobutanol nitrite 2 B373
 Nitro-C-butyl-aminotoluene 2 B377
 Nitrobutylcresol 2 B381
 N-Nitro-N-(n-butyl)-N'-nitroguanidine 2 B384
 8-Nitrocaffeine 2 C3
 Nitrocaillebotte (Fr) 3 C577
 Nitrocamphenes 2 C19–C20
 Nitrocarbmates see Carbamic acid 2 C40 ff
 Nitrocarbamic acid see Carbamic acid 2 C40 ff
 Nitrocarbamic acid ethyl ester 2 C41
 Nitrocarbamic acid methyl ester 2 C42
 Nitro-carbonitrate (NCN) blasting agents 8 N114
 Nitrocellulose see Cellulose Nitrates 2 C100 ff
 Nitrochlorbenzenes see Chlorobenzene . . . 3 C248–C251
 Nitrochlorin 8 N114

- 3-Nitro-2-chloroethanol **3** C255
- 2-Nitro-2-chloroethanol nitrate **3** C255
- Nitrochloroform see Chloroform . . . **3** C256
- Nitrocinnamic acid azides **3** C323
- Nitrocoal see Coal, nitrated **3** C378
- Nitrocolle (Fr) **6** G85
- Nitrocolophony (Fr) **8** N114
- Nitrocoopalite V & VIII **3** C512
- Nitrocopper **8** N114–N115
- Nitrocotton see Cellulose **2** C95 ff; **8** N115
- Nitrocresols see Cresols **3** C556–C558
- Nitrocresolsulfonic acid expl see Cresolsulfonic acid **3** C558
- Nitrocresylates see Salts of trinitrocresol **3** C557
- Nitrocumenes see Nitro derivs of cumene **3** C573–C574
- Nitrocurds see Curds **3** C577
- Nitrocyanoacetamide **3** C583
- Nitrocyanoacetic acid **3** C584
- Nitrocyanoacetic acid ethyl ester **3** C584
- Nitrocyanoacetic acid methyl ester **3** C584
- Nitrocyanoacetyl azide **3** C584
- Nitrocyanoacetyl hydrazide **3** C584
- Nitrocyanoguanidine **3** C585
- 2-Nitrocyclohexanol **3** C597
- 2-Nitrocyclohexanone **3** C597
- 1-Nitrocyclohex-1-ene **3** C599
- 5-Nitro-1,3-cyclopentadiene **3** C602
- Nitrocyclopentanone **3** C604
- Nitrocymenes **3** C637
- Nitroderivs of dichlorophenol **5** D1214–D1215
- Nitroderivs of diethylbenzylamine **5** D1229
- Nitroderivs of diethylphenylenediamine **5** D1247–D1248
- Nitroderivs of dihydroxybenzaldehyde **5** D1270
- Nitroderivs of dimethoxybenzaldehyde **5** D1302
- Nitroderivs of dihydroxybenzoic acid **5** D1289
- Nitroderivs of N-methylaniline **8** M99–M102
- 6-Nitro-6-desoxy-D-glucose **3** D91
- 6-Nitro-6-desoxy-L-idose **3** D91
- Nitrodextrin **5** D1115
- N-Nitro-diaminoethane **5** D1137
- 4-Nitro-1,2-diazole **5** D1165
- 4 (or 5) -Nitro-1,3-diazole **5** D1166
- Nitrodiazonaphthol see Diazonaphthol **5** D1168–D1169
- Nitrodiazophenol see Diazophenol **5** D1172
- 6-Nitro-4-diazopyrocatechol **5** D1173
- 5-Nitro-3-diazopyrocatechol-1-methyl ether **5** D1173
- 6-Nitro-4-diazo-resorcinol-3-methyl ether **5** D1174
- 6-Nitro-4-diazotoluene-3-sulfonic acid **8** N115
- 2-Nitrodibenzylamine **5** D1188
- 2-Nitro-3,5-dibromo-4-diazophenol **5** D1193
- Nitrodicyandiamidine **5** D1217–D1218
- Nitrodiglycolamic acid dinitrile **5** D1262
- Nitrodiglycolamidic acid **5** D1262
- 3-Nitro-2,5-dihydroxy-1,4-benzoquinone **5** D1290
- N-Nitrodimethylamine **5** D1306
- 2-Nitro-5,5-dimethyl-1,3-cyclohexanedione **5** D1333
- 1-Nitro-5,5-dimethylhydantoin see Dimethylhydantoin **5** D1343
- N'-Nitrodimethylmethyleaminoguanidine **5** D1348
- N-Nitro-N,N'-dimethylmalonamide **5** D1348
- N-Nitro-N-(2-dinitroethyl)-acetamide **6** E195
- 2-Nitro-2-(3',5'-dinitrophenyl)-propanediol-1,3 **8** N115
, dinitrate **8** N116

- Nitro-diphenyl-acetonitrile **5** D1415
 4- (or p) Nitrodiphenylamine **5** D1430
 2-Nitro-1,2-diphenyl-1-ethanol **5** D1458–D1459
 2-Nitro-1,2-diphenylethanol nitrate **5** D1459
 Nitrodiphenylnitrosoamines **5** D1430–D1431
 Nitrodulcite see Dulcitol **5** D1567
 Nitroerythrite **5** E124–E125
 Nitroethanes see Ethane, nitrated **6** E143 ff
 Nitroethanols **6** E177 ff
 Nitroethenylamidooxime **6** E185
 4-Nitro-N-ethylacetanilide (nitromannol) **6** E196
 1-Nitroethylacetylene **6** E201
 2-Nitroethylacrylate **6** E202
 Nitroethylaminotoluene **6** E334–E335
 Nitro-N-ethylanilines **6** E206
 3- (or 4-) Nitroethylbenzamides **6** E208–E209
 N-Nitroethyl-2,2-dinitropropylamine **6** E326
 4-(2-Nitroethyl)-3,5-dinitro-1,2,4-triazole **6** E336
 Nitroethylene **6** E229
 Nitroethyleneaminooxime **6** E230
 Nitro-N,N'-ethylenediglycolamide dinitrate
 6 E246
 1-Nitroethyleneguanidine **6** E280–E281
 Nitroethylene-iso-thiourea **6** E291
 Nitroethylene polymer (NEtPol) **6** E229–E230
 Nitroethylenes **6** E229 ff
 N-Nitro-ethylglycinate **6** E295
 β -Nitroethylidene aniline **6** E303
 β -Nitroethylidene-4-nitroaniline **6** E303
 2-Nitroethyl isopropyl ether **6** E311
 2- (or 4-) Nitro-N-ethyl-N-methylanilines **6** E309
 N-(2-Nitroethyl)-N-methylaniline **6** E309
 Nitroethylmethylbenzenes **6** E309–E310
 N-Nitro-N-ethyl-4-nitroaniline **6** E206
 3-Nitro-3-ethylpentane **6** E315
 Nitro ethylphenylacetic acids **6** E318
 Nitro ethylphthalates **6** E324
 2-Nitro-2-ethyl-1,3-propanediol dinitrate
 6 E325–E326
 2-Nitro-2-ethyl-1,3-propanediol (NEP) **6** E325
 N-Nitro ethylpropylamine **6** E326
 2-(2-Nitroethyl) pyridine **6** E327
 3- (or 4- or 5-) Nitroethylsalicylate **6** E329
 Nitro ethyl toluenes
 3-Nitro-N-ethyl-p-toluenesulfonamide **6** E334
 4-Nitro-ethyl-o-toluenesulfonate **6** E333
 β -Nitro- β -ethyl-trimethyleneglycol **6** E336
 Nitroethyl-trinitroethoxyphenylurea **6** E294
 N-Nitro-N'-ethylurea **6** E337
 N-Nitro-ethylurethane **6** E337
 Nitro-ethyl-n-valerates **6** E338–E339
 5- (or 6-) Nitro-4-ethyl-m-xylene **6** E340
 5-Nitro-4-(N-ethyl)-oxyldine **6** E341
 Nitroferrites **8** N116
 2-Nitrofuran **6** F240
 Nitrofuranols **6** F241–F242
 5-Nitrofurfural-2 (& -3) **6** F242–F243
 5-Nitro-furfural-N-nitriminoguanidine **6** F243
 5-Nitro-furfuraloxime **6** F243
 5-Nitro-furfural semicarbazone **6** F243–F244
 2-Nitro-2-furoamide **6** F245
 Nitro furoic acids **6** F245–F246
 5-Nitro-2-furoyl-hydrazide **6** F246
 5-Nitro-2-furoyl hydroxamic acid **6** F246
 5-Nitro-2-furoyl nitrile **6** F247
 5-Nitro- β -furylacrylic acid **6** F247
 Nitrogalactose see d-Galactose **6** G8
 Nitrogelatine picrique **8** N116
 Nitrogelatinedynamiten **8** N116
 Nitrogelatines **8** N116

- Nitrogen chloride 3 C240
- Nitrogen detn in energetic materials
8 N116–N121
- Nitrogen-halogen compounds 8 N121–N129
nitrogen bromides 8 N121
nitrogen chlorides 8 N122–N123
nitrogen fluorides 8 N123–N128
nitrogen iodides 8 N128–N129
- Nitrogen iodide 7 I118–I120
- Nitrogen oxides 8 N129–N133
nitrogen monoxide 8 N129
nitrogen oxide 8 N129–N130
nitrogen pentoxide 8 N130
nitrogen tetroxide 8 N130–N132
nitrogen trioxyfluoride 8 N133
- Nitrogenous acid 6 G62
- Nitrogen trifluoride 6 F144
- Nitro- α -glucoheptose see d- α -Glucoheptose
hexanitate 8 G82
- Nitroglucosan see β -Glucosan-2,3,4-trinitrate
6 G83
- Nitroglucose 5 D1116; see d-Glucose penta-
nitrate 6 G83
- Nitroglucosides 8 N133
- Nitroglutazine 6 G86
- Nitroglycerin (NG) 5 D1593–D1594; 6 G98 ff
- Nitroglycerin-Nitrocellulose Dynamites (Ger)
8 N134
- Nitroglycerol shell 6 G108
- Nitroglycol (NGc) 5 D1594; 6 G114–G115
- N-Nitroglycolurethane nitrate 6 G117
- Nitroglyoxime 6 G119
- Nitroguanidine 6 G154–G158
- Nitroguanidine and derivs, analytical procedures
6 G160–G161
- Nitroguanidine expls 6 G158–G159
- Nitroguanidine nitrate 6 G159
- Nitroguanidine perchlorate and diperchlorate
6 G159
- Nitroguanidine, requirements and tests of
6 G161–G164
- Nitroguanidine silver salt 6 G160
- 1-(N-Nitroguanyl-N-nitro- β -aminoethyl)-2-
nitrimino-3-nitroimidazolidine 7 I33–I34
- Nitro halogen derivs of methane 8 M72–M74
- Nitrohay 7 H14–H15
- Nitroheptanes see Heptanes 7 H61 ff
- Nitrohexanes 7 H87
- Nitro-hexenes 7 H92–H93
- 4-Nitrohippuryl-aminoacetyl azide 7 H114
- Nitrohoney 7 H168
- N-Nitrohydantoin 7 H188
- Nitrohydrazinopyridine 7 H209
- Nitrohydroene 8 N134
- Nitrohydroquinone 7 H228
- 6-Nitro-3-hydroxy-1,2-benzoquinone-2-oxime-
4-diazonium hydroxide 2 B86
- 5-Nitro-3-hydroxybenzoyl azide 7 H136
- Nitroindene polymer (N.I.P.) 8 N134
- [α -Nitroisoamyl]-iso-nitramine 1 A395
- Nitro-iso-butanediol dinitrate 2 B370
- Nitro-iso-butanetriol 2 B371
- Nitro-iso-butane triol triacetate 2 B372
- Nitro-iso-butanetriol trinitrate 2 B371–B372
- Nitroisobutylglycerin 8 N112
- Nitroisobutylglycerol trinitrate (NIBGTN)
8 N112–N113
- Nitro-iso-butylglycol dinitrate (NIBGkDN)
8 N113
- 2-Nitro-iso-butyramide 2 B391
- Nitrokrakites 8 N135
- Nitrokrut see Berg (expl) 2 B101
- Nitrol 8 N135
- Nitrolactose 7 L1–L2

- Nitrolic acids **8** N135
 ethylnitrolic acid **8** N135
 methylnitrolic acid **8** N135
 propylnitrolic acid **8** N135
- Nitrolin **8** N135
- Nitroline **8** N136
- Nitrolit see 2,4,6-Trinitroanisole **1** A450–A452
- Nitrolite **8** N136
- Nitrolkrut **8** N136
- Nitrolysol **7** L63
- Nitromagnite **8** N136
- Nitromaltose **8** M10
- Nitromannite **8** M13 ff
- Nitromannitone **8** M13
- Nitromannol see 4-Nitro-N-ethylacetanilide
6 E196
- Nitromannose **8** M17
- Nitromatweed **8** M45
- 2-Nitro-mesitylene **8** M62
- Nitrometer **8** N136
- Nitromethane see Methane **8** M69 ff
- Nitromethoxymethoxymethyl nitrate **8** N136
- Nitromethoxy methyl nitrate **8** N137
- 5-[3'-Nitro-4'-methoxy-phenyl]-tetrazole **1** A456
- N'-Nitromethyleneaminoguanidine **5** D1348
- N'-Nitro-N-methyleneaminoguanidine **8** N137
- 5-Nitro-2-(o-methyl)-furoyl hydroxamic acid
6 F246
- 1-Nitro-5-methylhydantoin **8** M106–M107
- N-Nitro-N-methylhydroxyacetamide nitrate
8 M107
- Nitromethyl-iso-nitramine **8** N137
- 4-(1-nitromethyl) toluene **6** E332
- Nitron **8** N137
- Nitronitraminoanthraquinones **1** A183
- Nitronitraminohydroxyanthraquinones
- 1-Nitro-2-nitramino- Δ^2 -imidazoline
1 A220; **7** I33
- 1-Nitro-2-nitraminoimidazoline-2 **6** E281
- Nitronitraminopyridines **1** A254–A255
- Nitronitraminoquinolines **1** A256
- Nitronitraminotoluenes **1** A265
- 5-Nitro-nitrato-ethyl-2-furoate **6** F246
- 1-Nitro-2-nitriminoethyleneguanidine **6** E281
- 4-Nitro (2-nitroethyl) benzene **6** E209–E210
- 5-Nitro-N-nitro-N-methyl-2-furoamide **6** F245
- 2-Nitro-2-(m-nitrophenyl)-propanediol-1,3-
 dinitrate **8** N137–N138
- Nitronitrosoacetanilides **1** A23
- Nitronitrosaminoguanidine **1** A213–A214
- 6-Nitro-4-nitrosoamino-3-hydroxy-1,2-
 benzoquinone-2-oxime **2** B86
- 4-Nitro-6-nitrosoamino-5-hydroxy-1,2-
 benzoquinone-2-oxime **2** B86
- Nitronitrosoantipyrenes **1** A472
- Nitro nitroso derivs of N-methylaniline
8 M102–M103
- Nitropenterythrite (Fr) **8** N138
- 1-(o-Nitrophenyl)-2-nitroethyl nitrate **8** N138
- p-Nitrophenyl-phenylacetonitrile **5** D1415
- Nitrophycite **8** N138
- Nitropolene **8** N138
- Nitropolyglycerin see Tetranitroglycerin
5 D1261
- Nitropolymers **8** N138–N157
- α -chloro- α -nitroethylene **8** N142
- dinitro polystyrene **8** N143–N144
- 2,2-dinitropropylacrylate (DNPA)
8 N139–N140
- ethylene glycol dinitrate **8** E278–E279
- glycidyl-4,4,4-trinitrobutyrate **8** N140–N141
- nitrated ethylene glycol **6** E279–E280
- nitroallyl acetate **8** N139
- 1-nitro-butyne **8** N141
- nitro ethyl acrylate **6** E201–E202
- nitroethylene **6** E229–E230

Nitropolymers (cont'd)

- nitroindene 8 N142–N143
 the polymethane polymer of 2,5-dinitraza-1,6-hexane diisocyanate and 2,2-dinitro-1,3-propanediol 8 N150
 the polyamide polymer of 4,4-dinitro-1,7-heptanedioyl chloride and 3,3-dinitro-1,5-pentanediamine 8 N140
 the polyester polymer of 4,4-dinitro-1,7-heptanedioyl chloride and 2,2-dinitro-1,3-propanediol 8 N141–N142
 the polymethane polymer of 3,3-dinitro-1,5-pentane diisocyanate and 5,5-dinitro-1,2-hexanediol 8 N145
 ibid 4,4,6,8,8-pentanitro-1,11-undecanediol 8 N146–N147
 ibid 5,7,9-trinitro-5,7,9-triaza-3,11-dioxal-1,13-tridecanediol 8 N147
 the polyurea polymer of 3,3-dinitro-1,5-pentane diisocyanate and 3,4-dinitro-1,5-pentanediamine 8 N144–N145
 the polyurethane polymer of 2,5-dinitraza-1,6-hexane diisocyanate and 3,5,5-trinitro-1,2-pentanediol 8 N150
 the polyurethane polymer of 3,3-dinitro-1,5-pentane diisocyanate and 2,2-dinitro-1,3-propanediol 8 N145–N146
 ibid 4,4,6,6,8,8-hexanitro-1,11-undecanediol 8 N147
 ibid 2,2,4,4-tetranitro-1,5-pentanediol 8 N146
 ibid 5,5,5-trinitro-1,2-pentanediol 8 N146
 the polyurethane polymer of 2-nitraza-1,4-butane diisocyanate and 2-nitromethyl-1,3-propanediol 8 N149
 ibid 5,5,5-trinitro-1,2-pentanediol 8 N149–N150
 the polyurethane polymer of 2-nitro-2-aza-1,3-butane diisocyanate and 5,5-dinitro-1,2-hexanediol 8 N149
 the polyurethane polymer of 3,3,4,7,7-pentanitro-5-aza-1,9-nonane diisocyanate and 2,2-dinitro-1,3-propanediol 8 N148–N149
 ibid 5,5,5-trinitro-1,2-pentanediol 8 N148
 the postnitrated polyurethane polymer of 3-nitro-aza-1,5-pentane diisocyanate and 5,5-dinitro-1,2-hexanediol 8 N153
 ibid ethyleneglycol 8 N153
 ibid water 8 N145

Nitropolymers (cont'd)

- the postnitrated polyurethane polymer of 3,6-dinitro-3,6-diaza-1,8-octane diisocyanate and 2,2-dinitro-1,3-propanediol 8 N154–N155
 ibid with N,N'-bis (2-hydroxyethyl) oxamide 8 N156–N157
 ibid 5,5-dinitro-1,2-hexanediol 8 N155
 ibid ethyleneglycol 8 N155
 ibid 2-methyl-2-nitro-1,3-propanediol 8 N156
 ibid 5,5,5-trinitro-1,2-pentanediol 8 N155–N156
 the postnitrated polyurethane polymer of 3,3-dinitro-1,5-pentane diisocyanate with N,N'-bis (2-hydroxyethyl) oxamide 8 N152
 ibid 5,5-dinitro-1,2-hexanediol 8 N151
 ibid ethylene glycol 8 N151
 ibid 3-nitro-3-aza-1,5-pentanediol 8 N152
 ibid 5,5,5-trinitro-1,2-pentanediol 8 N151–N152
 the postnitrated polymer of ethylene diisocyanate and ethylene dinitramine 8 N150–N151
 the postnitrated polyurethane polymer of 3-nitraza-1,5-pentane diisocyanate and 5,5,5-trinitro-1,2-pentanediol 8 N154
 ibid N,N'-bis (2-hydroxyethyl) oxamide 8 N153–N154
 ibid 2-nitro-2-methyl-1,3-propanediol 8 N154
 3-Nitropropene 1 A138
 2-Nitropropyl-butyrates 5 D1496
 5-Nitrosalicyl-salicylic acid 5 D1503
 5-Nitrosamino-3-amino- γ -s-triazole 5 D1148
 5-Nitrosamino-3-carboxy- α -sym-triazole 2 C67
 5-Nitrosamino-3-carboxy- α -sym-triazole ethyl ester 2 C67
 5-Nitrosamino-1-p-ethoxy-phenyl- α -vic-tetrazole 1 A202
 5-Nitrosamino-1-methyl- α -tetrazole 1 A234
 Nitrosaminomethyltriazoles 1 A236
 5-Nitrosamino-1-phenyl- α -tetrazole 1 A248
 2-Nitrosamino-1,3,4-thiadiazole 1 A262
 5-Nitrosamino- α -sym-triazole-3-carboxylic acid 1 A270

- Nitrosiminothiazoline 7 I35
 5-Nitrosoamino-2-amino-1,3,4-thiadiazole
 5 D1145
 Nitrosoanilinotriazole 1 A441
 Nitrosoantipyrene 1 A472
 1-Nitrosoazetidide 1 A519
 Nitrosobenzaldehyde 2 B35
 Nitrosobenzanilides 2 B40
 Nitrosobenzenes and nitronitrosobenzenes
 2 B44–B45
 Nitrosobenzocarbazole 2 B66
 Nitrosobenzyltoluidine 2 B100
 Nitrosobromobenzene 2 B309
 Nitrosobromomethylaniline 2 B313
 Nitrosobromophenol 2 B315
 N-Nitroso-N-butylaniline 2 B378
 N-Nitroso-N-(n-butyl)-N'-nitroguanidine 2 B384
 N-Nitroso-N-(n-butyl)-urethane 2 B389
 iso-Nitrosocamphor 2 C23
 Nitrosocarbamic acid ethyl ester 2 C41
 Nitrosocarbamic acid methyl ester 2 C42
 Nitrosocarbanilide 2 C44
 Nitrosochloromethane 3 C259
 Nitrosochloromethylaniline 3 C260
 Nitrosochloromethylaniline 3 C261
 Nitrosochlorophenol 3 C262
 Nitrosochloropropane 3 C264
 Nitroso-p-cymol-2-diazonium nitrates 5 D1160
 Nitroso derivs of N-methylaniline 8 M103
 4-Nitroso-2-diazoresorcinol 5 D1174
 4-Nitroso-2,6-dibromophenol 5 D1194
 N-Nitroso-o,N-diethylhydroxylamine 5 D1237
 Nitrosodiglycolamidic diazide 5 D1262
 N-Nitrosodimethylamine 5 D1306
 N-Nitroso-N,N'-dimethylhydrazine 5 D1346
 5-Nitroso-2,4-dinitroanisole 1 A450
 4-Nitroso-1,3-dinitro-5-bromobenzene 2 B309
 N-Nitroso-N-[2,4-dinitrophenyl]-hydrazine
 7 H207
 4-Nitrosodiphenylmethanol 5 D1466
 Nitrosoethylene 6 E230
 N-Nitrosoethyleneimine 6 E282
 Nitroso furanols 6 F241
 Nitrosoguanidine 6 G164–G165
 Nitroso halogen derivs of methane 8 M86–M87
 β -Nitroso-iso-butane 2 B368
 2-Nitroso-iso-butyramide 2 B391
 2-Nitroso-iso-butyronitrile 2 B393
 Nitrosomethanoxime 8 N157
 1-Nitroso-2-nitramino- Δ^2 -imidazoline 1 A220
 1-Nitroso-2-nitraminoimidazoline-2 6 E281
 1-Nitroso-2-nitriminoethyleneguanidine 6 E281
 1-Nitroso-4-nitro-2-bromobenzene 2 B309
 2-Nitroso-2-nitrobutane 2 B367
 5-Nitroso-5-nitrocumene 2 C20
 Nitroso-nitro-dibenzylmethane 5 D1189
 Nitrosodimethylbenzene 5 D1322
 X-Nitroso-X-nitro-2,4-dimethylbenzoic acid (?)
 5 D1327
 4-Nitroso-1-nitro-2,3-dimethylbutene-(2)
 5 D1331
 3-Nitroso-3-nitro-2,4-dimethylpentane 5 D1362
 Nitrostarch 8 N157–N162
 , containing expl compositions 8 N161–N162
 , expl properties of 8 N160–N161
 , history of 8 N158
 , preparation of 8 N158–N159
 , properties of 8 N157–N158
 , stabilization of 8 N159–N160
 Nitrostilbene-diazoniumhydroxide 5 D1175
 Nitrosyl azide 1 A594
 Nitrosyl chloride 3 C240; 8 N162

- Nitrosyl fluoride **6** F144–F145; **8** N162–N163
- Nitrosyl perchlorate **8** N163
- Nitrosylsulfuric acid **8** N163
- 1-Nitro-3-(2,2,2-trifluoroethyl)-guanidine **6** G165
- 1-Nitro-4-(2,2,2-trinitroethyl)-benzene **6** E213
- 1-Nitro-3-(2,2,2-trinitroethyl)-guanidine **6** E298
- N-Nitrotrinitroethylurethane **6** E337–E338
- N-Nitro-trinitroethyl-methane-sulfonamide
6 E308–E309
- Nitrous fumes **8** N163–N164
- Nitroxidialkylnitramines see Hydroxydialkyl-
amines **7** H239
- 1-Nitroso-3,6-diazaheptane dinitrate
6 E182–E183
- N-(2-Nitrosoethyl)-butylnitramine (BuNENA)
7 H240
- N-(2-Nitrosoethyl)-cyclohexylnitramine
(cyclohexyl-NENA) **7** H240
- N-(2-Nitrosoethyl)-ethylnitramine (EtNENA)
7 H240
- N-(β -Nitrosoethyl)-N'-methylenedinitramine
7 H242
- N-(β -Nitrosoethyl)-methylnitramine (MeNENA)
7 H241–H242
- 1- β -Nitrosoethyl-2-nitrimino-3-nitroimidazoli-
dine **7** I33
- N-(β -nitrosoethyl)-N'-nitroguanidine **7** H241
- N-(β -nitrosoethyl)-N-nitro-N'-nitroguanidine
7 H241
- N-(β -nitrosoethyl)-N-nitroso-N'-nitroguanidine
7 H241
- Nitroxyl fluoride **6** F145
- 1-Nitroso(trimethylene-3-nitramine
5 D1377–D1378
- Nitryl chloride **3** C240; **8** N164–N165
- Nitryl fluoride **8** N165
- Nitryl perchlorates **8** N165
- NK **8** N165
- Nobel-Abel (detonation) equation of state
4 D290
- Nobel, Alfred Bernard **8** N165–N167
- Nobel-Ardeer powder **8** N166
- Nobelit **8** N166–N167
- Nobel's Carbonite **8** N167
- Nobel's Gelignite **8** N167
- Nobel's mortar **8** N167
- Nobel's patent blasting oil **8** N167
- Nobel's powder-Dynamite **8** N167–N168
- Nobel's safety powder **8** N168
- Nobel, Sir Andrew **8** N168
- Nobel's 704 see British military expls **2** B301
- Nobel's wetterdynamit **1** **8** N168
- Nobelit **8** N168
- Nobelita antigrisu gelatinized see Spanish
permissible expls **3** C455
- Nobelite (Fr) **8** N168
- No-fire level **8** N168
- NOL no 130 primer mixture see Lead styphnate,
basic **5** D1278
- Nomenclature of organic compounds **1** II–VI
- Nomenclature used by US armed forces for
ordnance items **4** D753
- NONA **8** N169
- Nonafluorodiaminomethylguanidine **6** G165
- Noncased charges **8** N170
- Nonideal detonation **4** D389–D390
- Non-permissible (Amer) or nonpermitted (Brit)
see Commercial expls **3** C435–C437; Coal
mining expls **3** C368 ff
- Nord 5210 (SS.11 and AS.11) (Fr)
8 N170–N171
- Nordenfelt and Meurling powder **8** N171
- Normal (or specific) volume (test) see Volume of
gases evolved on detonation **1** XXVI
- Normal powder **8** N171
- Norrbin, J.H. **8** N171

Norris powder 8 N171

Norsabite 8 N171

Nougat method 8 N171

Nuclear activation analysis and detection
8 N173–N206

, detection of expls in buried mines
8 N196–N198

, detection of hidden expls in baggage
8 N196–N204

, detn of gunpowder residues in forensic
investigations 8 N186–N196

, detn of pellet weight in primers
8 N182–N185

, element analysis 8 N174–N182

; expls safety in neutron activation analysis
8 N204–N205

Nuclear counting of tagged expls by liquid
scintillation 8 N207–N210

Nuclear fission rocket 1 A504–A505 see Atomic
weapons and ammunition 1 A504–A505

Nuclear tracers in expls chemistry 8 N210–N219
, tracer studies on the nitrolysis of hexamine
to RDX & HMX 8 N211–N216
, use of C-14 to study the origin of TeNMe in
TNT manufacture 8 N210–N211
, use of S-35 to characterize the sulfate
content in NC 8 N216–N218

Nudets 8 N219

Nuevo Anagon 8 N219

Nuodex see Laminac 4116 7 L3

Nutation 8 N219

NX 8 N219

Nyalite 8 N219

Nylon, aminoethyl see Aminoethylnylon
1 A205

Nysebastine 8 N219

Nysol 8 N219

O

- Oakley quarry powder 8 O1
 Oaklites 8 O1
 Oare powders 8 O1
 Oarite 8 O1
 Oat hulls, nitrated 8 O1
 Obermuller's test 8 O1
 O'Brien expl 8 O2
 Obscuring power of white smokes 8 O2—O3
 Obturate 8 O3
 Obturated, or percussion type primer 8 O3
 Obturation 8 O3—O4
 Obturates 8 O4
 Obturator pad 8 O4
 Obturator rings 8 O4
 Obturator spindle 8 O4
 Obus (Fr), military phrases 8 O4
 Occupational diseases and hazards in expls and
 ammunition plants see Industrial hygiene
 7 I93
 OC, expls du type (Fr) 2 C155 ff
 o-Chlorobenzylmalonitrile (CS) 8 O4—O5
 Ochse's cartridges 8 O5
 Octafluoroaminomethylguanidine 6 F165
 Octafluorocyclobutane 6 F145
 Octamethylolcyclohexanediol 8 O5—O6
 Octanitrocellulose 8 O6
 Octanitro-3,3-di-p-tolylphthalide 5 D1517
 Octanitroethylenediphenyldiamine see Ditetryl
 5 D1513
 Octazatrienes 8 O6
 Octogen (Ger) see Cyclotetramethylenetetramine
 (HMX) 3 C605—C610; 8 O6
 Octol 8 O6—O17
 Octyl 8 O17
 Odite 8 O17
 Oerlikon 8 O17
 O, expls du type (Fr) see Cheddites 2 C155 ff
 Off-carriage fire control 8 O17
 Offensive grenade 8 O17—O18
 Offset bombing 8 O18
 Offset distance 8 O18
 Off-the-shelf-items 8 O18
 OFS 8 O18
 OFX 8 O18
 Ogive 8 O18
 Ogive, false 8 O18
 Ogive, rifle grenade 8 O18
 Ohlsson, J.V. 8 O18
 Oil-expl combinations see AN blasting expls
 1 A341 ff; Slurry expls 6 E469
 Oils, nitrated 8 O18
 Okell's powders 8 O18—O19
 Oleates 8 O19
 Olefins, nitrated 8 O19—O20
 2,2-dibromo-1-nitroethane 8 O20
 dinitrobutenes 2 B376
 X,X-dinitrocarylene 2 C40
 2,5-dinitrofurane 6 F241
 3,4-dinitro-3-hexene 7 H92—H93
 ethylene nitro 6 E282
 eulite 6 E342—E343
 1,1,1,6,6,6-hexanitro-3-hexene 7 H93
 mononitrobutene 2 B375—B376
 3-nitroacrylic acid 1 A97
 5-nitro-3-ethylhexene 8 O20
 5-nitrofurfural-N-nitriminoguanidine 6 F243
 trinitrobutene 2 B376
 Oleum 8 O20
 Olin powder 8 O20
 Oliver, Gen Paul A. 8 O21
 Oliver Powder Co 8 O21
 Oliver's flameless Dynamite 8 O21

- Oliver's powder 8 O21
 Onager 8 O21
 On-carriage fire control 8 O21
 Oncin 8 O21
 Onit 8 O21
 Ontos 8 O21
 Opacifiers in solid propnlts 8 O21–O22
 Open ammunition space 8 O22
 Open bomb 8 O22
 Opening charge 8 O22
 Open pit test 3 C346–C349
 Ophorite 8 O22
 Oppau disaster 8 O22
 Optical chronograph 8 O22
 Optical methods for study of detonation see
 Camera, high-speed . . . 2 C13–C19;
 Detonation, explt procedures 4 D299 ff
 Optical method for testing caps 1 XIX
 Optical methods in ballistics see Cameras, high
 speed 2 C13–C19
 Optical microscopy 8 M125–M127
 Optimum density see Limiting density 3 D66
 Optimum gun see Drozdov, N.F. 5 D1555
 Optolene 8 O23
 Orange powders 8 O23
 Orbital bomb 8 O23
 Ordnance 8 O23–O26
 , definition of 8 O23
 , department 8 O23–O26
 Organ gun 8 O26
 Organic hypochlorites 7 H261–H262
 Organic peroxides and hydroperoxides
 7 H224–H227
 Organic promoters 8 O26
 Organic vapors expln hazard, reduction of see
 Detonation hazards 4 D366–D367, D245;
 Expln hazards . . . 6 E373
 Orgues 8 O26
 Oriastites 8 O26
 Oriental powder 8 O26
 Origin-identification of TNT 8 O27
 Ormites 8 O27
 Orsman's expls 8 O27
 Ortho-nitroaromatic compounds; hazards in
 handling 8 O27
 Orthophosphites 8 O27
 Ortho-salicylaldehyde azide 7 H233
 Oscillograph 8 O27
 Oscillographic polarography 3 C303
 03 (0-three) expl see Explosifs 03 6 E363
 Otter 8 O27–O28
 Ottoson's military Dynamite see PATR 1760
 5 D1611
 Out-of-line safety 8 O28
 Output characteristics 8 O28
 Output tests for detonators, primers, igniters
 and fuzes 4 D1078
 Outrigger 8 O28
 Outrigger torpedoes 8 O28
 Overdetonation wave, overdriven or supported
 4 D687
 Overhit 8 O28
 Overpressure 8 O28
 Overspin 8 O28
 Oxalate blasting powders 8 O28
 Oxalate carbonite see Cooling agents 3 C511;
 8 O29
 Oxalate compounds, listing of 8 O29–O32
 Ba oxalate 8 O29
 Ca oxalate 8 O29–O30
 lead oxalate 8 O30
 mercuric oxalate 8 O30
 mercurous oxalate 8 O30
 potassium oxalate 8 O30
 silver oxalate 8 O30
 sodium oxalate 8 O31

- Oxalate compounds (cont'd)
 Sr oxalate 8 O32
- Oxaldihydroxamic acid 8 O32–O33
- Oxalhydrazone oxamide 5 D1141
- Oxalic acid 8 O33
- Oxalic acid, anhydrous 8 O33
- Oxalic acid dihydrazide 8 O33–O34
- Oxalic acid, salts of 8 O34
 anhydro-tris-[hydroxymercuri]-acetic acid
 8 O34
 ethane hexamercarbide 8 O34
 tris-[hydroxymercuri]-acetic acid 8 O34
- Oxalyl-ethyl ester azide 8 O35–O36
- Oxamic acid azide 8 O35
- Oxamide 8 O35
- Oxanilide and derivs 8 O35–O36
 2,4,6,2',4',6'-hexanitrooxanilide (HNO)
 8 O36–O37
 2,4,2',4'-tetranitrooxanilide (TNO) 8 O36
- Oxaziranes 8 O37
- Oxazolidone and derivs 8 O38
 3-nitrooxazolidone 8 O38
 3-nitrosooxazolidone-(2) 8 O38
- Oxides, inorganic 8 O38–O45
- Oxides, inorganic, listing of selected 8 O45–O54
 Al oxide 8 O45
 arsenic pentoxide 8 O45
 arsenic trioxide 8 O45–O46
 Ba oxide 8 O46
 Be oxide 8 O46
 Bi oxide 2B162
 B oxide 2 B252–B253
 Br oxides 2 B306–B307
 Cd oxides 8 O47
 Ca oxide 8 O47
 Ce oxide 8 O47–O48
 Cl oxides 3 C243–C244
 chromic acid 3 C298–C299
 chromic oxide 3 C299
 Cu oxides 6 F15–F17
 lead oxides 7 L9–L10
 Mg oxide 8 M9
 Mn oxides 8 M12
 Mo trioxide 8 O48
- Oxides, inorganic, listing of selected (cont'd)
 nitrogen oxides 8 N129–N133
 potassium oxide 8 O49
 Si dioxide 8 O49–O50
 Si monoxide 8 O50–O51
 sodium oxide 8 O51
 Sn oxide 8 O51
 Ti dioxide 8 O51
 tungsten dioxide 8 O52
 Xe tetroxide 8 O53
 Xe trioxide 8 O53
 Zn oxide 8 O53–O54
- Oxidized rosin 8 O54
- Oxinite 8 O54
- Oxland powder 8 O54
- 6-Oxo-2,4-diimino-hexa-hydro-1,3,5-triazine
 1 A273
- N-Oxoethenylamidooxime 6 E185
- Oxonite 8 O54
- Oxonium compounds 8 O54–O55
- 1-Oxy-6-aminobenzotriazole 1 A188
- 5-Oxy-1,5-azotetrazole 8 O55
 Ba salt 8 O55
 sodium salt 8 O55
- Oxybenzoic acid, nitrated lead salt 8 O55–O56
- Oxycellulose and derivs 8 O56–O57
 nitrogen peroxide oxycellulose 8 O56
 nitrooxycellulose 8 O57
- Oxydimercuriacetaldehyde 8 O57
 chloratodimercuriacetaldehyde 8 O57
 nitratodimercuriacetaldehyde 8 O57
 nitritodimercuriacetaldehyde 8 O57
- 1,1'-(Oxydimethylene)-bis [hexahydro-3,5-dinitro-s-triazine] see Bis (1,3,5-triaza-3,5-dinitro-cyclohexylmethyl)-ether 2 B159
- Oxydine 8 O57
- Oxygen balance 8 O57–O62
 , detonation product computation: effect of
 density 8 O59
 , expln fumes 8 O58–O59
 , expl "power" 8 O59–O62
- Oxygen fluoride 8 O62
- Oxyliquit 8 O62–O63

1- (or N) Oxytetrazole 8 O63

Ozobenzene (Fr) 8 O63

Ozocerite 8 O63

Ozone 8 O63—O66

Ozone expls or ozonides 8 O66—O73

acetyleneozonide 8 O67

alkylacetone-oxo-ozonide 8 O67

amyleneozonide 8 O67

benzene triozone 8 O67

biphenyl tetraozonide 8 O67

n-butadiene-caoutchouc ozonide 8 O67

butylene-oxo-ozonide dimer 8 O67—O68

β -butyleneozonides 8 O68

cyclohexene-oxo-ozonide polymer 8 O68

cyclohexene ozonides 8 O68—O69

cyclopentene-oxo-ozonides 8 O69

cyclopentadiene-ozonide 8 O69

diallyldiozonide 8 O69

dimethylhexadiene-1,5-diozonide 8 O69

diphenyltetraozonide 8 O69—O70

ethylene ozonide 8 O70

Ozone expls or ozonides (cont'd)

ethylozonide 8 O70

fumaric acid ozonide 8 O70

α -hexylene ozonide 8 O70

iso-crotonicacid-ozonide 8 O68

iso-dicyclopentadienediozonide 8 O69

iso-eugenolozonide 8 O70

isoprene rubber ozonides 8 O70

D-limonenediozonide polymer 8 O71

mesityloxiodeozonide 8 O71

mesityloxiodeperozonide 8 O71

methyleugenolozonides 8 O71

naphthalene diozonide 8 O71

phenanthrene diozonide 8 O71

phoronediozonide 8 O71

pineneozonide 8 O71

polydihydrodicyclopentadiene ozonide 8 O71

propylene-oxo-ozonide 8 O72

α -terpineol ozonide 8 O72

toluene ozonide 8 O72

urushioldimethyletherozonides 8 O72

urushioldimethylethertetraozonide 8 O72

o-xylene ozonide 8 O72—O73

- P-2 8 P1
- PA 8 P1
- PAA same as Picramic acid 1 A241–A243
- Packaging of ammunition and expls 8 P1–P3
- ; ammunition for artillery 8 P2
 - ; ammunition for small arms 8 P2
 - ; expl bombs, mines, projectiles, torpedoes or grenades 8 P2
 - ; fireworks (pyrotechnics) 8 P2
 - ; fuzes and tracers 8 P2
 - ; HE gels 8 P2
 - ; HE liquids 8 P2
 - ; initiating HEs 8 P2
 - ; nuclear weapon major assemblies 8 P2
 - ; liquid proplnts 8 P2
 - ; rocket ammunition with expl loaded projectiles 8 P2
 - ; solid proplnts 8 P2
- Packed tower see Absorption towers 1 A7
- PAD's 2 C70–C72
- "PA" expls 8 P1
- Paleine 6 F235; 8 P3–P4
- Palmer's expl 8 P4
- Panclastites see Anilite 1 A443; 8 P4–P5
- Panclastites-Guhr 8 P5
- Pandora 8 P5
- Panel test 3 C349–C350
- Pannonit 8 P5
- Pantopolit 8 P5
- Panzerfaust 8 P5
- Panzergranate 8 P5
- Panzerhandmine 3 7 H3
- Panzerschreck 8 P5
- Panzerwurfkannone 8 P5
- Paper chromatography 3 C292–C294
- Paper chromatography, paper partition chromatography 3 C289–C298
- Papers, expl 6 E424
- Papite (Fr) 8 P6
- "P.A." (poudre) 8 P1
- Paraffin 8 P6–P7
- Paraffin oil 8 P7
- Paraffins, nitrated (expls) 8 P7–P11
- nitroisobutylglycerintrinitrate 8 P7–P9
 - 2-nitro-2-methyl-1,3-propanediol dinitrate 8 P9–P10
 - 2-nitro-2-methyl-1-propanolnitrate 8 P10–P11
 - , partial listing of 8 P11
- Paraformaldehyde 6 F164; 8 P11 (expls); 8 P11
- Paragon 8 P12
- Paraldehyde 1 A14
- Paraldol see Acetaldol 1 A15
- Parammons 8 P12
- Paraplex 8 P12
- Paraplex P-10 8 P12
- Paraplex proplnts 8 P12–P13
- Paraplex resin-bonded expl 8 P13
- Paravane 8 P13
- Parazl see Commercial dinitrodichlorobenzene 5 D1207–D1208; 8 P13–P14
- Paris gun 2 B113–B114
- Parkes' absorbent for NG 8 P14
- Parlon 8 P14
- Parone expl 8 P15
- Parr calorimeter (Parr bomb) 8 P15
- Parrott gun 8 P15
- Particle size effects in detonation 8 P15–P18
- , initiation phenomena 8 P17–P18
 - , steady detonation 8 P16–P17
- Particle size measurements of solid proplnts, expls and pyrots 8 P18–P59
- , adsorption methods 8 P52–P54
 - , air jet screening 8 P27–P30
 - , density variation adsorptiometric 8 P44–P49
 - , density variation gravimetric 8 P43–P44

- Particle size measurements of solid propnlts, expls and pyrots (cont'd)
- , dry sieving or screen analysis 8 P23–P27
 - , electrical properties 8 P55–P58
 - , electroformed sieves 8 P31–P33
 - , elutriation process 8 P33–P37
 - , gas flow 8 P51
 - , image formation 8 P54–P55
 - , MSA-Whitby particle size analyzer 8 P38–P41
 - , permeability to fluid flow 8 P50–P51
 - , pipette methods 8 P43
 - , sedimentation balances 8 P49–P50
 - , sedimentation columns: gas 8 P41–P43
 - , sedimentation columns: liquid 8 P38
 - , sedimentation process 8 P37
 - , wet sieving 8 P27
- Partition chromatography 3 C292
- Partridges (mortars) 8 P59
- Pastilles antilueurs (Fr) 8 P59
- Patch 8 P59
- Pate explosible (Fr) 8 P59
- Patent blasting powder 8 P59
- Patent gunpowder 8 P59
- Pattison expls 8 P59
- Pauli cartridge 8 P60
- Paulille's gray Dynamite 8 P60
- Paullile's white Dynamite 8 P60
- Paul's chronograph 8 P60
- Payload 8 P60
- PBX 8 P60–P77
- , history of 8 P60–P62
 - manufacture of PBX type expls 8 P62–P65
 - , tabulated properties of 8 P67–P74 (tables 3–5)
 - , testing procedures for 8 P66–P67
 - , toxicity of 8 P67
 - , uses of 8 P67
- PCX see 3,5-Dinitro-3,5-diazapiperidinium nitrate 5 D1386; 8 P77
- PD 8 P77
- PDNR 8 P77
- PE 8 P77
- PE-1, -2, -3A, 4 expls 8 P77–P78
- Peak pressure in detonation and explosion 2 B181; 4 D484–D485
- PEAP 8 P78
- Peat, nitrated 8 P78
- Pebble powder (P powder) 8 P78
- Pectin nitrates 8 P78
- Pedersen device 8 P78
- Pelargonic acid esters 8 P78–P79
- Peley expl paper (Fr) see Expl papers 6 E424
- Pellet loading see Loading and fabrication of expls 7 L46–L57
- Pellet powder (Fr) 8 P79
- Pellet powder 8 P79
- Pellier expl 8 P79
- Pelouze, Theophile-Jules 8 P79
- Pembrite 8 P79
- Pendulum, ballistic, test see Physical tests 1 VII–VIII; 8 P79
- Pendulum chronograph 8 P80
- Pendulum friction device test see Friction sensitivity test 1 XIII–XIV
- , (qual) 6 F204
 - , (quant) 6 F204
- Penetration aids 8 P80
- Penetration of targets by lined-cavity jets, steady and nonsteady 4 D576
- Penryhn antifrost powder 8 P80
- Penta 8 P80
- Pentaborane 2 B254–B256; 8 P80
- 3-Pentadecylphenol 8 P80 trinitro 8 P80
- Pentaerythritol (PE) 8 P80–P83
- mononitrate (PEMN) 8 P82–P83
 - ibid (FA-PEMON) 8 P83
- Pentaerythritol acetate trinitrate 8 P121
- Pentaerythritol allyl ether trinitrate 8 P122

- Pentaerythritol bis [tris (difluoramino) methyl ether] dinitrate (FA-PEDIN) 8 P84
- Pentaerythritol cyclic ether dinitrate 8 P83
- Pentaerythritol diacetate dinitrate 8 P84
- Pentaerythritol diacetate dipropionate (PEAP) 8 P123
- Pentaerythritol diallyl ether dinitrate 8 P84
- Pentaerythritol dichloride dinitrate 8 P84
- Pentaerythritol diformate dinitrate 8 P84
- Pentaerythritol diglyceryl ether hexanitrate 8 P125
- Pentaerythritol diglycolate tetranitrate see (2,2-Dimethylol)-dimethylol-glutarate tetranitrate 5 D1353; 8 P124
- Pentaerythritol dimethyl ether dinitrate 8 P84
- Pentaerythritol dinitrate 8 P83
- Pentaerythritol formate trinitrate 8 P122
- Pentaerythritol methacrylate trinitrate 8 P122
- Pentaerythritol methyl ether trinitrate 8 P122
- Pentaerythritol monochlorohydrin trinitrate 8 P122
- Pentaerythritol monoglyceryl ether pentanitrate 8 P125
- Pentaerythritol monolactate tetranitrate 8 P125
- Pentaerythritol nitrobenzoates trinitrate (ortho, para, meta and 3,5-dinitro) 8 P122–P123
- Pentaerythritol propionate trinitrate 8 P123
- Pentaerythritol propyl ether trinitrate 8 P123–P124
- Pentaerythritol tetra-acetate (PETA) 8 P121
- Pentaerythritol tetrabenzoate 8 P123
- Pentaerythritol tetrakis 8 P123
- Pentaerythritol tetrakis [tris (difluoramino) methyl ether] (FA-PE) 8 P124
- Pentaerythritol tetralactate tetranitrate 8 P125
- Pentaerythritol tetranitrate (PETN) 8 P86–P121
 , chemical properties 8 P91–P92
 , combustion and DDT of 8 P113–P114
- Pentaerythritol tetranitrate (PETN) (cont'd)
 , detonation characteristics 8 P94–P107
 , physical properties 8 P86–P89
 , preparation of 8 P94
 , solubility of 8 P89–P91
 , specifications and analytical procedures for 8 P92–P94
 , thermal decomposition of 8 P107–P112
- Pentaerythritoltetranitramine 5 D1140
- Pentaerythritol trinitrate (Petrin) 8 P84–P86
- Pentaerythritol trinitrate tris (difluoramino) methyl ether (FA-PETRIN) 8 P124
- Pentaerythritol vinyl ether trinitrate 8 P124
- Pentaerythritylamines 8 P125–P128
 pentaerythrityldiamine 8 P125
 pentaerythrityldiguanidine 8 P125–P126
 pentaerythrityltetrakis (2-aminoethylamine) 8 P127
 pentaerythrityltetrakis (dichloramine) 8 P126
 pentaerythrityltetrakis (nitramine) (PETX) 8 P126–P127
 pentaerythrityltetrakis (trimethyl ammonium Br) 8 P127
 pentaerythrityltetramine 8 P127–P128
 pentaerythrityltriamine 8 P126
- Pentafluoroguanidine 6 G165–G166
- Pentaglycerin trinitramine 8 M117
- Pentaglycerin trinitrate 8 M117 and M120
- Pentaglycerol 8 M116, M120
- Pentaglycol 5 D1357
- Pentaglycol dinitramine 5 D1369
- Pentaglycol dinitrate 5 D1358
- n-Pentane and derivs 8 P128–P130
 alkyl substituted dinitropropanes 8 P129–P130
 3,3-diazido-2,4-dinitratopentane 8 P129
 dinitropentanes 8 P129
 mononitropentanes 8 P129
 polynitropentanes 8 P130
- Pentane, iso- 8 P130
- 2,3,4,5,6-Pentanitroaniline (PNA) 1 A414
- Pentanitroazobenzene 1 A649
- 2,4,2',4',6',6'-Pentanitrobenzil 2 B65

- Pentanitrobenzocarbazole **2** B66
 Pentanitrobenzylaniline **2** B94
 Pentanitrobenzyltoluidine **2** B101
 2,4,6,2',4'-Pentanitrobibenzyl **2** B111
 Pentanitrobiphenol **2** B122
 Pentanitrobiphenylcarboxylic acid **2** B125
 Pentanitrocellulose **2** C100
 Pentanitroderivs of benzylphenyl ether **2** B99
 Pentanitrodesoxyinositol **2** D92
 Pentanitrodiethylenediamine **5** D1247
 Pentanitrodihydroxybenzophenyltriazole **2** B79
 Pentanitrodimethylaminoaniline
 5 D1306–D1307
 2,4,2',4',6',6'-Pentanitro-3-dimethylaminodi-
 phenylamine **5** D1310
 Pentanitro-N,N-dimethylaniline (tetralita no 2)
 5 D1316
 Pentanitrodimethyl-m-phenylenediamine
 5 D1363
 Pentanitrodiphenylamines **5** D1434
 Pentanitrodiphenylethanol **5** D1459
 Pentanitrodiphenylethers **5** D1453
 Pentanitrodiphenylethylene **5** D1456
 2,4,2',4',5',5'-Pentanitrodiphenylethylol **5** D1459
 2,4,6,2',4'-Pentanitrodiphenylmethane **5** D1466
 2,4,6,2',4'-Pentanitrodiphenylsulfide **5** D1477
 2,4,2',4',6'-Pentanitrodiphenylsulfone
 (PNDPhSo) or thionol **5** D1480
 Pentanitrodipropylamines **5** D1493–D1494
 Pentanitroethylaniline **6** E207
 X,X,X,X,X-Pentanitrofluoran **6** F119–F120
 Pentanitrofluoranthene **6** F120
 2,4,6,2',4'-Pentanitrohydrazobenzene
 5 D1462–D1463
 2,4,2',4',5',5'-Pentanitro- α -hydroxybibenzyl
 7 H238
 Pentanitromethylaniline **8** M101
 2,4,6,2',4'-Pentanitro-3-methylnitraminodi-
 phenylamine **1** A231
 Pentanitronaphthol **8** N20
 Pentanitrophenylbenzylamine **1** A229
 Pentanitrophenylmethylnitramine **8** M102
 2-Pentanone **8** P131
 3-Pentanone **8** P131
 Pentastit **8** P131–P132
 Pentazenes **8** P132
 I,V-diphenyl-pentazene **8** P132
 [I,III-diphenyl, V-tolyl] pentazene **8** P132
 [I,V (di-4-tolyl), 3-ethyl] pentazene **8** P132
 [I,V-di-4-tolyl] pentazene **8** P132–P133
 [I&III-di-4-tolyl, V-phenyl] pentazene **8** P133
 [I,III,V-triphenyl] pentazene **8** P133
 [I,III,V-tri-4-tolyl] pentazene **8** P133
 Pentek **8** P133
 Penthrinit (Swiss) **3** C443; **6** G51–G52
 (table G17)
 Pentofive **8** P1333
 Pentolites **8** P133–P136
 Pentonal **8** P136
 Pentralite same as Pentanitromethylaniline
 8 M101–M102
 Pentrinit **8** P136
 Pentrit **8** P136
 Pentrite **8** P133
 Pentritol (Ger) **8** P137
 Pentryl same as 2-(2',4',6'-Trinitro-N-nitranilino)-
 ethanol nitrate **1** A424–A429
 Pentryl and Pentro **8** P137
 Pentyl **8** P137
 Pentyl azide see Amylazide **1** A395–A396
 Pentyl nitrate see Amyl nitrate **1** A397
 PEP-3 **8** P137–P138
 Pepperbox **8** P138
 Pepper pot **8** P138
 Peracids, organic **8** P202–P203 (table 6),
 P212–P214

- Perafex **8 P138**
- Peralite **8 P138**
- Perammons **8 P138**
- Potassium percarbonate **8 P138–P139**
- Perchloratits **8 P139**
- Perchloratminensprengstoffe (Ger) **8 P139**
- Perchloratsprengstoffe **8 P139–P140**
- Perchloric acid and perchlorates **8 P140–P172**
 , historical and general information on
8 P140–P141
 , inorganic perchlorate expls **8 P171–P172**
 , inorganic perchlorates (listing) **8 P145–P172**
 , inorganic perchlorate military expls
8 P171–P172
 , perchloric acid **8 P141–P145**
- Perchlorit **8 P172**
- Perchlorocellulose, Perchloronitrocellulose,
 Perchloroglycerin and Perchloronitroglycerin
8 P172
- Perchromic and perpoly perchromic acids and
 their salts **8 P172–P173**
 diperchromic acids **8 P173**
 monoperchromic acids **8 P172–P173**
 triperchromic acids **8 P173**
- Peroronit **8 P173**
- Percussion **8 P173**
- Percussion cap **1 A473; 3 C577**
- Percussion (expl) bullet **8 P173**
- Percussive force of an expl **1 XIX; 8 P174**
- Percussion fuze **4 D882**
- Percussion gun **4 D755**
- Percussion lock **8 P174**
- Percussion powder **8 P174**
- Perdit **8 P174**
- Perfluoroethylene **6 E291**
- Perfluorosuccinamide-Li Al hydride (danger of
 explosion) **8 P180**
- Perforated grains (proplnts) see Cannon proplnt
2 C30–C31
- Perform see 3,7-Dinitroso-1,3,5,7-tetraazabicyclo
 [3.3.1]-nonane **5 E91**
- Performance of expls or proplnts **8 P174–P176**
 , brisance **8 P175**
 , detonation velocity **8 P175**
 , power **8 P175**
 , sensitivity **8 P175–P176**
- Performance tests, practical **8 P176**
- Performance vs constitution of expls
8 P180–P182
- Performic acid **8 P182**
- Periodic acid and periodates **8 P176–P177**
 ammonium periodate **8 P177**
 potassium periodate **8 P177**
- Perkins expl **8 P177**
- Perkoronit **8 P177–P178**
- Perlit **8 P178**
- Permanganates **8 P179–P180**
 ammonium permanganate **8 P178**
 complex expl salts of **8 P180**
 potassium permanganate **8 P178–P179**
 sodium permanganate **8 P180**
 silver diaminopermanganate **8 P180**
 silver permanganate **8 P180**
- Permissible or permitted expls **8 P182–P183**
- Permissibility tests in galleries **1 XIX**
 see Galleries for testing permissible expls
1 XIV; 3 C370–C378
- Permonite **8 P183**
- Pernitral **8 P184**
- Pernitrosoisonitrosocamphor **2 C23**
- Peroxides **8 P184–P218**
 ozonides **8 O66–O73, P209–P210**
 , diacyl **8 P214–P216**
 , inorganic **8 P184–P198**
 , (listing) **8 P210–P212**
 , organic **8 P199–P209**
 , peroxy acids **8 P212–P214**
 , peroxy esters **8 P216–P218**
 poly **8 P218**
- Peroxides of naphthols **8 N20**
- Peroxydisulfuryl difluoride **6 F145**

- Persalites, gesteins **8 P218**
 Pertit **8 P218**
 Pertuiset powder see Mundell powder **8 M161**
 PETA **8 P219**
 Petard (Fr) **8 P219**
 Petard d'alarme (Fr) **8 P219**
 Petard de mineurs (Fr) see Miner's squib **8 M134**
 Petard pour simuler des tirs de batterie (Fr) **8 P219**
 Petards (ou artifices) pour signaux (Fr) **8 P219**
 Petavel pressure gauge see Closed bomb **3 C337**
 Peters' and Lindsley's expl **8 P219**
 PETN **8 P219**
 Petragite **8 P219**
 Petralite **8 P219**
 Petralithe (Fr) **8 P219–P220**
 Petrin **8 P220**
 Petrin acrylate **8 P220**
 Petrofacteurs **8 P220**
 Petroklastit **8 P221**
 Petroleum, nitrated **8 P221**
 Petrolit **8 P221**
 Petronel see Bullets **2 B324**
 Pettingell **8 P221–P222**
 Pettman cement **8 P222–P223**
 PETX **8 P223**
 Peyton powder **8 P223**
 "P" (expls) **8 P1**
 "P" (expls de mine) **8 P1**
 P gunpowder **8 P223**
 PGX **8 P223**
 Phenacyl azide see ω -Azidoacetophenone **1 A47**
 Phenacyl-3,5-dinitrosalicylate **8 P223**
 Phenanthrene and derivs **8 P223–P224**
 1,2,3,4,4a,4b,5,6,10,10a decahydro-1,4a-dimethyl-7-(1-methylethyl)-phenanthrene-1-carboxylic acid polynitrate **8 P224**
 phenanthrene diozonide **8 P223–P224**
 3,4,8-trimethoxyphenanthrene-5-carboxylic acid azide **8 P224**
 Phenanthrene diozonide **8 O71**
 9,10-Phenanthrene quinone **8 P224–P226**
 azidophenanthrene quinones **8 P225**
 4-nitrophenanthrenequinonemonoxime mono semi carbazone **8 P225–P226**
 phenanthrene quinone-2,7-diazide **8 P225**
 Phenetedines see Aminophenetoles **1 A240**
 Phenetole and derivs **8 P226–P228**
 dinitrophenetoles **8 P226–P227**
 mononitrophenetoles **8 P226**
 2,3,5,6-tetranitrophenetole **8 P228**
 trinitrophenetoles **8 P227–P228**
 Phenixsprengstoffe **8 P228**
 Phenol and derivs **8 P228–P234**
 azidophenols **8 P229–P230**
 dinitrophenols **8 P230–P232**
 mononitrophenols **8 P230**
 nitrosophenols **8 P233–P234**
 pentanitrophenols **8 P233**
 tetranitrophenols **8 P233**
 trinitrophenols **8 P232–P233**
 Phenolsulfonic acids and derivs **8 P234–P235**
 dinitrophenolsulfonic acids **8 P234–P235**
 mononitrophenolsulfonic acids **8 P234**
 trinitrophenolsulfonic acids **8 P235**
 Phenothiazine **8 P235**
 1,3,5,7-tetranitrophenothiazine **8 P235**
 β -Phenoxyethanol and derivs **8 P235–P237**
 β -(2,4-dinitrophenoxy) ethanol **8 P236**
 ibid nitrate **8 P236**
 β -(2,4,6-trinitrophenoxy) ethanol nitrate **8 P236–P237**
 N-Phenylacetamide same as Acetanilide **1 A22**
 Phenyl acetonitrile see Benzyl cyanide and derivs **2 B95–B96**
 Phenylaldehyde see Benzaldehyde and derivs **2 B35**

- Phenylamine see Aniline 1 A406–A414
- Phenylaminobutane see Butylaniline 2 B278 ff
- Phenylaminobutanol see Anilinobutanol 1 A422
- Phenylaminoethane see N-Ethylaniline 6 E206
- Phenylaminoethanol see Anilinoethanol
1 A424 ff
- Phenylaminomethane see N-Methylaniline
8 M97 ff
- Phenylaminopropanediol see Anilinopropanediol
1 A434
- Phenylaminopropanol see Anilinopropanol
1 A436
- Phenylaniline see Aminobiphenyls 1 A191
- Phenylarsonic acid 8 P237–P238
lead-2,4,6-trinitrophenylarsonate 8 P238
- Phenylazide and nitrated derivs see Azido and
azidonitro derivs of benzene 2 B42 ff
- Phenylazoanilines see Aminoazobenzenes 1 A184
- Phenylbenzamide and derivs see Benzanilide
and derivs 2 B40–B41
- Phenylbenzoic acid see Biphenylcarboxylic acid
2 B125
- Phenyl cyanide see Benzonitrile and derivs
2 B76–B77
- Phenyldiazosulfide 8 P238
p-nitrophenyldiazosulfide 8 P238
- Phenyldichloramine 8 P238
- Phenylenediamines or diaminobenzenes
8 P238–P240
salts and additive compounds 8 P239–P240
- α -Phenylethanol and deriv 8 P241
 β -nitro- α -[2-nitrophenyl]-ethanol nitrate
1 P241
- β -Phenylethanol 8 P241
 β -[2,4,6-trinitrophenyl] ethanol 8 P241
 β -[2,4,6-trinitrophenyl] ethanol nitrate
8 P241
- Phenylether see Diphenylether 5 D1352 ff
- Phenylethylamine see Ethylaniline 6 E206 ff
- Phenylethyleneglycol 8 P241
- bis (Phenylethyleneglycol)-ether derivs see
Ethyleneglycol diphenylether 6 E255
- Phenylethyleneglycol nitrated products
8 P241–P242
- [1-Phenyl (3- α -“ethylpropionate”), 4-carb-
oxamide]-tetrazine (1) 8 P247
- (1-Phenyl, 3-ethyl)-tetrazine (1) 8 P245
- Phenylguanidine 8 P242
dinitrophenylnitroguanidine 8 P242
2,4,6-trinitrophenylguanidine 8 P242
N-2,4,6-trinitrophenyl-N'-nitroguanidine
8 P242
- Phenylhydrazine and derivs see
Hydrazinobenzene 7 H207 ff
- Phenylmercaptan see Benzenethiol and derivs
2 B63
- Phenylmethanol and derivs see Benzyl alcohol
and derivs 2 B91–B92
- Phenylmethyl ether, nitrated compounds see
Anisole 1 A448 ff
- [2-Phenyl, 5-methyl]-tetrazole 8 P247
- Phenylnitramine 8 P242–P243
2,3, and 4-nitrophenylnitramines 8 P243
2,3,4,6-tetranitrophenylnitramine 8 P243
2,4,6-trinitrophenylbutylnitramine see Butyl
tetryl 2 B379
2,4,6-trinitrophenylethylnitramine see Ethyl
tetryl 6 E207, E319
2,4,6-trinitrophenylnitramine 8 P243
- Phenylnitromethane 8 P243
3,5-dinitrophenylnitromethane 8 P243
(m-nitrophenyl)-dinitromethane and salts
8 P243–P244
- 1-Phenyl-4-nitro-5-nitraminobenzotriazole see
Aminobenzotriazoles 1 A190
- 1-[5-Phenyloxazolyl-(2)]-benzenediazonium
8 P244
- 1-Phenyl-1-oxy-III-benzenesulfonyl-triazine
8 P248
- 1-Phenyl-III-p-phenylmercaptotolyl-triazine
8 P248
- N-Phenyl-s-picryl-isothiurea 5 D1484

- 2-nitro-2-(3'-nitro Phenyl)-propanediol-1,3-dinitrate 8 P244
- 2-nitro-(3',5'-dinitro Phenyl)-propanediol-1,3-dinitrate 8 P244-P245
- Phenylpropionic acid, 4-nitro- 8 P245
- Phenylsulfohydroxide see Benzsulfuric acid and derivs 2 B60-B61
- 1-Phenyl-tetrazole 8 P245-P246
[1-(p-nitrophenyl)]-tetrazole 8 P246
- 2-Phenyl-tetrazole 8 P246
- 5-Phenyl-tetrazole 8 M246
[5-(m-nitrophenyl)]-tetrazole 8 P246
- Phenyltoluidines see Anilintoluene; diphenyl-methylamines 1 A438 ff
- Phenyltriazene 8 P247-P248
- P.H.E. (plastic high expl) 8 P223
- Phermex 8 P248
- Phlegmatization of expls see Desensitization of expls 3 D88-D90; Microencapsulation 8 M123-M125
- Phloroglucinol 8 P248-P249
trinitrophenylglucinol 8 P248-P249
ibid, lead salt of 8 P249
- Phoenix powders 8 P249-P250
- Phorone 8 P250
- Phoronediozonide 8 O71
- Phosgene (CG) 8 P250-P251
- Phosphate, 2,2-dinitropropyl 8 P492
- Phosphine 8 P251
- Phosphorescence see Fluorescence 6 F124
- Phosphorus-nitrogen azide 1 A594
- Phosphorus oxychloride 8 P255
- Phosphorus pentachloride 8 P255-P256
- Phosphorus pentafluoride 6 F145
- Phosphorus pentoxide 8 P256
- Phosphorus (red) 8 P251-P253
- Phosphorus trichloride 8 P256-P257
- Phosphorous trifluoride 6 F145
- Phosphorus trioxide 8 P257
- Phosphorus (white or yellow, WP) 8 P253-P255
- Photochemistry of expls 8 P258-P262
- Photography in ballistic and aerodynamic investigations see Cameras, high-speed 2 C13-C19
- PH-salz 8 P262
- Phthalic acids and derivs 8 P262-P264
; azides and diazides 8 P264
dinitrophenthalic acids 8 P263-P264
mononitrophenthalic acids 8 P263
2,4,6-trinitro-m-phthalic acid 8 P264
- Phthalic anhydride 8 P265
- Phthalide 8 P265
3,3-diazidophthalide 8 P265
- Phthaloylperoxide 8 P265
- PHX see 1-Acetoxyethyl-3,5,7-trinitro-1,3,5,7-tetrazacyclooctane 1 A52
- Physical tests for determining explosive and other properties 1 VII-XXVI;
4 D1078-D1092 ff
Abel's test 1 VII
ability to propagate detonation 1 VII
absorption of moisture 1 VII, XVI
action of light on expls, etc 1 VII; 7 L14
aptitude a l'inflammation, essai 1 VII, IX, X
armor plate impact test 1 VII
available energy 1 VII
ballistic pendulum test 1 VII-VIII
behavior towards heat tests 1 VIII, IX, X,
XVII, XXII-XXIII
Bergmann-Junk test 1 VIII
Bichel bomb 1 VIII
blast effects 1 VIII; 2 B180-B184
blasting caps and detonators, initiating efficiency 1 VIII, XVIII
bomb drop tests 1 VIII
booster sensitivity 1 VIII
brisance or shattering effect 1 VIII-IX;
2 B299-B300
bulk compressibility and bulk modulus 1 IX
bullet impact sensitiveness test 1 IX;
2 B332-B334
burning rate tests 1 IX
burning tests 1 IX
calorimetric tests for expls, proplnts and pyrots 1 IX

Physical tests for determining explosive and other properties (cont'd)

capability to burn tests 1 IX
 capability to inflame tests 1 IX
 cavity charge performance 1 IX
 Chalon test 1 IX
 characteristic product of Berthelot 1 IX
 closed vessel test 1 IX; 3 C330–C345
 coefficient d'utilisation pratique 1 IX–X
 combustion tests 1 X
 compression tests 1 X
 concrete tests 1 X; 3 C495
 cook-off test 1 X, A354
 copper cylinder compression (or crushing)
 test 1 X; 2 B299
 cratering effect 1 X; 3 C553
 Crawshaw-Jones apparatus 1 X; 3 C555
 crusher (crushing) tests 1 X; 3 C564
 CUP test 1 X
 Dautriche method for determination of
 velocity of detonation 1 X; 3 D17
 deflagration test 1 XVI; 3 D40
 deliquescence test 1 X, XVI; 7 H251–H254
 detonation in influence 1 X; 4 D395–D402
 detonation pressure 1 X; 4 D483–D491
 detonation rate determination 1 X;
 4 D632–D640
 detonators and blasting caps, initiating
 efficiency 1 XI, XVII
 distribution of shell fragment masses 1 XI
 drop test(s) 1 XI, XVII; 5 D1550–D1555
 earth cratering test 1 XI; 3 C553
 erosion of gun barrels 1 XI; 5 E112–E120
 Esop's test for efficiency of detonators 1 XI
 explosion by influence test 1 X;
 4 D483–D491
 expln temp test 1 XI, XVI–XVII;
 4 D583–D589
 expln time test 1 XI, XVII
 extent of propagation of expln 1 VII, XI;
 4 D402–D417, D497–D498; 6 E497
 exudation tests 1 XI
 falling weight test 1 XVII; 5 D1550–D1555
 FI test 1 XII; 6 F39–F40
 fire resistance tests 1 XXII–XXIII; 6 F31
 flame test 1 XII, XVII, XXIII; 6 F54
 flash point test(s) 1 XVI–XVII; 6 F80–F96
 flash test for caps 1 XII, XIX
 forty-four degree test 1 XI
 four cartridge test 1 XII; 4 D399
 fragmentation tests 1 XII; 6 F181

Physical tests for determining explosive and other properties (cont'd)

fragment density test 1 XII; 3 D84
 fragment gun 1 XII
 fragment velocity measurement 1 XIII;
 6 F181–F182
 freezing tests (for Dynamites) 1 XIII; 6 F188
 friction sensitivity tests 1 XIII–XIV;
 6 F204–F206
 fuse tests 1 XXII–XXIII
 galleries for testing permissible expls 1 XIV;
 3 C370–C378
 gap tests 1 XIV–XV; 4 D397–D399;
 6 G13–G14
 132° German test 1 XV
 granulation test 1 XV
 halved cartridge gap test 1 XV
 heats of combustion, expln and formation
 1 IX; 2 C10–C12; 9 T190–T204
 heat tests 1 XV–XVI; 7 H59
 hemispherical iron-dish test 1 XXII–XXIII;
 6 F31
 Hess' brisance test 1 VIII–IX; 2 B299–B300
 high speed optical devices used for measuring
 detonation rates 1 X; 4 D632–D640
 high-speed radiography 1 XVI
 hollow charge efficiency test 1 XXIII
 Hopkinson's pressure bar test 1 SVI
 humidity test 1 XVI; 7 H252–H254
 hygroscopicity test 1 XVI; 7 H251–H254
 ignition temp test 1 XVI–XVII; 3 D40;
 6 F80–F96
 ignition time tests 1 XVII; 6 E389
 impact-friction pendulum test 1 XVII, A354
 impact sensitivity test 1 XVII;
 5 D1550–D1555
 index of inflammability 1 XVII, XXII–XXIII
 inflammability tests 1 XXII–XXIII;
 7 I97–I98
 influence tests 1 X; 4 D395–D402
 initial velocity (muzzle velocity) determination
 2 B7–B8; 8 M162–M163
 initiating efficiency of detonators by the
 miniature cartridge test 1 XVIII; 8 M135
 initiating efficiency of initiating expls,
 determinations 1 XVIII
 initiating power, strength or value same as
 Initiating efficiency 1 XVIII
 initiating efficiency of primary expls by
 sand test 1 XVIII

Physical tests for determining explosive and other properties (cont'd)

initiation sensitivity by electrostatic discharges or sparks 1 XXII–XXIII; 5 E38–E55
 international 75° test 1 XVII
 iron-oxide-TNT test for detonators 1 XVIII
 same as Miniature cartridge test 8 M135
 Kast brisance meter see Brisance test methods 2 B299–B300
 Kast value same as above
 KI-heat test; see Abel's test 1 A2
 kraftzahl probe see Trauzl test 1 XXV–XXVI
 lead block test see Compression test 1 VIII–IX; 2 B299–B300
 lead block expansion test see Trauzl test 1 XXV–XXVI
 lead plate test see Plate tests 1 XX
 length and duration of flame test see Flame test 1 XII, XVII, XXIII; 6 F54
 maximum available work potential 1 XIX; see Detonation (and expln), work capacity in 4 D730
 maximum potential work same as Brisance value of Kast 1 VIII–IX
 maximum pressure of expln see Pressure of expln 1 XX
 mechanical shock 1 XIX; see Shock sensitivity of expls 9 S58–S83
 miniature cartridge test 1 XVIII; 8 M135
 miniature charge techniques 1 XIX
 miscellaneous safety tests for detonators and primers 4 D1088
 mortar test 1 XIX see Ballistic mortar test 2 B6
 Munroe-Neumann effect test see Shaped charge efficiency test 1 XIII
 muzzle velocity 2 B7–B8; 8 M162–M163
 nail test 1 XIX; 8 N1
 normal volume see Volume of gases evolved on detonation 1 XVI
 optical method for testing caps 1 XIX
 outlet tests 4 D1078
 pendulum friction device test see Friction sensitivity test 1 XIII–XIV; 6 F204
 percussive force of an expl 1 XIX; 8 P174
 permissibility tests in galleries 1 XIX see Galleries for testing permissible expls 1 XIV; 3 C370–C378
 physical testing of fuzes 4 D1092
 plate denting tests 1 XIX–XX
 plate tests 1 XX

Physical tests for determining explosive and other properties (cont'd)

potential 1 XX
 power of expl(s) 1 XX; 8 P364–P366
 pressure of gases developed on combustion of proplnts or expls 1 XX see Burning and burning characteristics of expls, including experimental procedures 2 B343–B346, Burning and burning characteristics of proplnts, experimental procedures 2 B349–B350
 pressure-bar apparatus of Hopkinson see Hopkinson's pressure-bar apparatus 1 XVI
 pressure of gases developed on expln or detonation 1 XX see Blast meters 2 B214–B215; Closed bomb (or vessel) and instruments for measuring pressure developed by expls or proplnts 3 C330–C345; Detonation (and expln) experimental procedures 4 D299 ff
 primary expls, initiating efficiency see Initiating efficiency of primary expls 1 XVIII
 product characteristic (Fr) see Characteristic product of Berthelot 1 IX
 propagation of detonation see Ability to propagate detonation 1 VII
 propagation test see Gap test 1 XIV
 propulsive force 1 XXI
 quickness of burning proplnt, determination 1 XXI see Coefficient de vivacite des poudres 3 C390–C391
 Quinan test 1 XXI
 rate of detonation test see Detonation rate tests 1 X; Experimental determination of detonation velocity 4 D632–D640
 red iron test see Sensitivity to flame, heat, sparks, etc 1 XXII–XXIII
 relative percussive force of an expl see Percussive force of an expl 1 XIX; 8 P178
 relative propulsive force of an expl see Propulsive force of an expl 1 XXI
 reprise d'humidite, essai (Fr) see Hygroscopicity 1 XVI; 7 H251–H254
 resistance to heat test 1 XXI
 rifle bullet test see Bullet impact sensitiveness test 1 IX; 2 B332–B334
 Rotter impact test see FI test 1 XII; 6 F39–F40
 sand test or sand crushing test 1 XXI–XXII; 9 S35

Physical tests for determining explosive and other properties (cont'd)

- sand test for detonators see Initiating efficiency of detonators by miniature cartridge test 1 XVIII; Initiating efficiency of primary expls by sand test 1 XVIII
- sensitivity to detonation by initiating agents see Sensitivity to initiation by detonators and boosters 1 XXII; Initiation 7 I106–I109
- sensitivity of expls, proplnts, and pyrot compositions tests 1 XXII see Detonation and expln experimental procedures 4 D299–D346; Initiation 7 I106–I109
- sensitivity to flame, heat, sparks, electrostatic discharges, etc 1 XXII–XXIII see Detonation experimental procedure 4 D299–D346; Initiation 7 I106–I109
- sensitivity to initiation by primary expls, detonators and boosters tests 1 XXIII see Detonation experimental procedure 4 D299–D346; Initiation 7 I106–I109
- setting point determination 1 XXIII, A612–A613
- shaped charge efficiency 1 XXIII
- shell impact sensitivity test 1 VII
- silvered vessel test 1 XXIV
- small lead block compression test see Compression tests 1 X; 3 C492–C494
- small lead block compression test for detonators see Esop's test 1 XI
- small lead block expansion test for detonators see Trauzl test 1 XXV–XXVI
- sound test for detonators 1 XXIV
- specific volume see Volume of gases evolved on detonation 1 XXVI
- stability (thermal) of expls and proplnts see Heat tests 1 XV–XVI; 7 H59
- steel plate denting test see Plate denting tests 1 XIX–XX
- strength of detonators, determination same as Initiating efficiency of detonators, tests 1 XVIII
- strength of Dynamites 1 XXIV see Ballistic mortar test 1 VII; Trauzl test 1 XXV–XXVI
- strength of expls, test 1 XXIV see Trauzl test 1 XXV–XXVI
- strength of expls, test 1 XXIV see Trauzl test 1 XXV–XXVI
- surveillance tests, 65.5° and 80° 1 XXIV

Physical tests for determining explosive and other properties (cont'd)

- surveillance test, 78° 1 XXIV
- sympathetic detonation test see Detonation by influence test 1 X; 4 D395–D402
- Taliani test 1 XXIV–XXV; 9 T29
- temperature developed on detonation 1 XXV see Experimental determination of temperature of detonation 4 D592–D601
- testing galleries see Galleries for testing permissible expls 1 XIV; 3 C370–C378
- time of ignition test see Ignition test 1 XVII; Expln-time test of double-base proplnts 6 E389
- transmission of detonation through air see Detonation by influence 1 X; 4 D395–D402
- transmission of detonation through expl charge see Ability to propagate detonation 1 VII
- Trauzl test 1 XXV–XXVI
- vacuum stability test 1 XXVI
- vapor pressure of expls, etc 1 XXVI
- velocity of detonation tests see Experimental determination of detonation velocity 4 D632–D640
- vitesse de detonation (Fr) see Detonation rate determination 1 X
- vivacite, determination de la (Fr) see Quickness of burning of proplnts, determination 1 XXI; 3 C390–C391
- volatility of expls and related substances 1 XXVI
- volume of gases evolved on expln or detonation 1 XXVI

PIAT 8 P265

Picarmite 8 P265–P266

Picatinny Arsenal 8 P266–P274

- , background 8 P267
- , history of 8 P267–P274
- , major functions 8 P266–P267
- , material assignments of 8 P267
- , mission of 8 P266

Picramic acid and salts 1 A241–A243

iso-Picramic acid see 2,6-Dinitro-4-aminophenol 1 A243

Picramide see 2,4,6-Trinitroaniline 1 A409

- Picrates **8** P274–P299
 , inorganic **8** P274–P276
 , inorganic, a listing of **8** P276–P283
 , organic **8** P283–P299
- Picrate whistles **8** P284
- Picratol **8** P284–P285
 , analytical **8** P285
 , expl properties of **8** P285
 , preparation of **8** P285
 , stability of **8** P285
- Picric Acid (PA) **8** P285–P295
 , chemical properties and thermal decomposition of **8** P288–P290
 , expl characteristics of **8** P292–P294
 , history of **8** P285–P286
 , physical properties, solubility and toxicity of **8** P286–P288
 , preparation of **8** P290–P292
 , specifications and analysis of **8** P290
 , thermochemical data on **8** P288
 , uses of **8** P290
- Picric acid expls and Picrate expls **8** P295–P296
- Picric Nitrogelatine **8** P296
- Picric powder **1** A1
- Picric powder see Abel powder **1** A1
- Picrinita **8** P296
- Picrit **8** P296
- Picrite see Guanyl nitramine **6** G154 ff
- Picrolonic acid **8** P296
- Picronitronaphthalene see Trinitronaphthalene **8** N12–N14
- 5-Picrylamidotetrazole **8** P247
- Picryl compounds **8** P296–P299
 picryl acetate and derivs **8** P297
 picryl allyl ether **1** A139
 picryl aniline and derivs **8** P297
 picryl azide see 2,4,6-Trinitrophenyl azide **1** A643; **2** B43; **8** P297
 picryl chloride see 2,4,6-Trinitrochlorobenzene **3** C250–C251; **8** P297
 picryldiazide see 1,3-Diazido-2,4,6-trinitrobenzene **2** B43
 picryl fluoride see Fluoro-2,4,6-trinitrobenzene **6** F137; **8** P297
- Picryl compounds (cont'd)
 picryl hydrazine see 2,4,6-Trinitrophenylhydrazone **7** H207
 picryl hydroxylamine toluene see 2,4,6-Trinitro-3-hydroxylaminotoluene **7** H247
 sodium salt **8** P297
 picrylnitramine **8** P297–P298
 picryloxamide **8** P299
 picrylphenylenediamines see Trinitroaminodiphenylamines **1** A197
 picrylpicryl compounds **5** D1488–D1490; **8** P298
 1-picryl-semicarbazide **8** P298
 1-picryl semioxamazine **8** P298–P299
 picryl sulfide see Hexanitrodiphenylsulfide **5** D1477
 picryl sulfone see Hexanitrodiphenylsulfone **5** D1480
 picryltetrazolylamine **8** P299
 picryltetrazylazide **8** P299
 picryltriethylenetetramine, 1,10-dinitro-1,4,7,10-tetra **8** P299
 picrylurea **8** P299
- Picryldiazide see 1,3-Diazido-2,4,6-trinitrobenzene **2** B43
- Picrylmercaptan see 2,4,6-Trinitrobenzenethiol **2** B63
- α -Picrylnitramino-iso-butyric acid **1** A423–A424
- Pieper expls **8** P299
- Pierre and Pottgiesser expl **8** P299
- Pierrit **3** C443
- Piezoelectric gages see Closed bomb . . . techniques **3** C339–C345
- P.I.G. and P.S.G. **8** P399–P300
- Pigou proplnts **8** P300
- Pike and Thew expls **8** P300
- Pikratol **8** P300
- Pikrinsaure (Ger) **8** P300
- Pile driving device **8** P300
- Pile test for Dynamites **8** P300
- Piling and stacking of ammunition **8** P301
- Pimelic acid and derivs **8** P301–P302
 4,4-dinitroheptanedioylazide **8** P301

- Pimelic acid and derivs (cont'd)
 4,4-dinitropimelic acid 8 P301–P302
 the polyester polymer 4,4-dinitropimelyl
 chloride and 2,2-dinitro-1,3-propanediol
 8 P302
- Pineneozonide 8 O71
- Pin-fire cartridge system 8 P302
- Pinite and derivs see Inositol and derivs
 7 I109–I110
- Pin method or pin oscillograph method for
 detonation rate measurement 3 C315
- Pin switch technique for measuring detonation
 velocity 3 C313–C319
- “Pinwheel” 8 P302–P303
- Piobert's law of combustion 8 P303
- Piombert's law 2 B346–P347
- PIPE 8 P303
- Pipeline digester for NC 8 P303–P304
- Piperazine and derivs see Diethylenediamine
 and derivs 5 D1230–D1231; 8 P304
- Piperazine chlorate 2 C190
- Piperidine and derivs 8 P304–P305
 diperidino-tetrazido cuprate 5 D1490
 1,3,3,5-pentanitropiperidine 8 P304
 N-perchlorylpiperidine 8 P304–P305
 piperidine-chromic acid 8 P304
 piperidine triazido cuprate 8 P305
- Pipitz proplnt 8 P305
- Piquet and Pochez expls 8 P305
- Piroadialiti see Pyrodialites 6 E366–E367
- Pirokollodion 8 P305
- Pironome see “Pyronome (1881)” 2 C206
- Pirsch proplnt 8 P305
- Pitite 8 P305
- Pitite no 2 8 P305
- Pittius expls 8 P305
- “Plancastita” 8 P305
- Plane combustion wave see Combustion wave
 propagation 3 C433; 8 P306
- Plane detonation waves with finite reactions see
 Detonation waves; steady-state, one-dimen-
 sional reaction waves with finite reaction rate
 4 D703–D704; 8 P306
- Plank (detonation) equation of state 4 D290
- Plant layout, location, design and construction
 8 P306–P307
- Plasma; its definition, generation and ordnance
 applications 8 P307–P310
- PLASTECS 8 P310–P312
- Plaster shooting see Agriculture and forestry
 uses of expls 1 A113; Mudcapping 8 M160
- Plastex eversoft 8 P312
- Plastic bonded expls see PBX 8 P60–P77
- Plastics and polymers, compatibility with expls
 see PLASTECS 8 P311–P312 (Refs 10, 25,
 32 & 33)
- Plastics and polymers, military applications see
 PLASTECS 8 P311–P312 (Refs 19 & 41)
- Plastit 8 P312
- Plastolit (Swiss) 3 C444
- Plastomenite (Fr) 2 B259
- Plastomenites 8 P313
- Plastrit 8 P313
- Plastrita (Span) 8 P313
- Plate denting tests 1 XIX–XX
- Plate tests 1 XX
- Plate tower see Absorption towers 1 A7
- Platinum 8 P313
- Platinum compounds 8 P313–P314
- Pleopentaerythritol 8 P314
- Plessit 8 P314
- Plodex expls 8 P314
- Plomoplastrita (Span) 8 P314
- Plosophore or explosophore see Auxoexplose
 1 A513–A514
- Plumbatols 8 P314–P315
- PLX 8 P318

- PNA same as 2,3,4,5,6-Pentanitroaniline 1 A414
- PNDPhSo see 2,4,2',4',6',6'-Pentanitrodiphenylsulfone 5 D1480
- PNL see D-1 3 D1
- Pohl's powder 8 P315
- Pobedity see Coal mining expls, Russian permissible expls 3 C454
- P.O.L. 8 P315
- Polar Ajax 8 P315
- Polar Dynabel no 2 8 P315-P316
- Polaris missiles 8 P316
- Polarite 8 P316
- Polar Thames powder 8 P318
- Polar Viking 8 P316
- Polis expl 8 P316
- Pollard expl 8 P316
- Pollard's test for stability of proplnts 8 P316
- Pollution abatement in the US military expls and proplnts manufacturing industry 8 P317-P324
 - , major steps in the manufacture of munitions 8 P317-P319
 - , munition plant modernization program 8 P320-P321
 - , wastewater streams—sources and types 8 P320-P321
- Polveri Italiani senzafumo 6 E134-E135
- Polvora progressiva de fusil tipo "G" 8 P324
- Polvoras negras (Span for Blk Pdrs) 8 P324
- Polyacetylenes (or polyynes) see Acetylenic condensation and polymerization products 1 A62-A63; 8 P326
 - diacetylene 5 D1120
 - diacetylenic dihydroperoxides 5 D1120
 - dichloroacetylene 5 D1203
 - 1,6-dichloro-hexa-2,4-diyne 8 D1298
 - 1,8-dimethyloctaacetylene 8 P325
 - 1,8-diphenylbutylacetylene 8 P325
 - 1,16-diphenyloctaacetylene 8 P325
 - 1,10-diphenylpentaacetylene 8 P325
 - hexa-1,5-diyne 8 P325
 - hexatriyne 8 P325
- Polyacetylenes (cont'd)
 - iodbutadiyne 8 P325
 - penta 1,3-diyne 8 P326
 - 2,2,23,23-tetramethyl-tetracos-7 ξ ,9 ξ ,15 ξ ,17 ξ -tetraene-3,5,11,13,19,21-hexayne 8 P326
- Polyacrylates 1 A96-A97; 8 P326
- Polyalkylbenzenes, nitration of 1 A129-A130; 8 P326
- Polyamide gels 8 P326
- Polyamides 8 P326-P327
- Polyamines 8 P327
- Polyaminoethylated cellulose 1 A203-A204
- Polyamylose 1 A398-A399
- Polyamylose, nitrated see Amylose 1 A398-A399
- Polybenzyl, nitrated see Benzyl chloride 2 B95; 8 P327
- Polybutadiene and its use as a binder with energetic materials 8 P327-P331
 - hydroxy-terminated polybutadiene 8 P327-P329
- Polybutene (PIB) 8 P331-P333
- Polycarbonates 8 P333-P334
- Polycyclopentylidene peroxide 3 C592
- Polydiamides see Diamides 5 D1125
- Poly (difluoroamino)-substituted cyanuric and isocyanuric derivs see Cyanuric acid 3 C589 ff; Difluoroamino compounds 5 D1258; 8 P334-P335
 - tris [1,2-bis] (difluoroamino)-ethyl isocyanurate 8 P334-P335
- Polydihydrodicyclopentadiene ozonide 8 O71
- Polyesters 8 P335-P338
- Polyether 8 P338-P339
- Polyethylene glycols see Ethyleneglycol polymers 6 E253; 8 P339
- Polyethyleneglycol ethers 8 P339
- Polyethyleneimine (PEI) and its perchlorate (PEIP) 8 P339

- Polyethylidene peroxide see Ethylidene-peroxide polymeric **6 E306**
- Polyethyl methacrylate see Ethyl methacrylate **6 E308**
- Polyfunctional organic azides **8 P339–P340**
 2,3-diazido-1,4-dinitratobutane (DADNBU) **8 P339**
 3,3-diazido-2,4-dinitratopentane (DADNPE) **8 P339–P340**
- Polygalitol and its tetranitrate **8 P340**
 polygalitol tetranitrate **8 P340**
- Polyglycidyl-2,2-dinitro-2-fluoroethyl ether binder for expls **8 P340**
- Polyglycidyl nitrate (polyurethane) proplnts (PGN) **8 P340–P341**
- Polyglycol ethers see Glycol, monophenyl ether of **6 G116**
- Polyglycols see Ethyleneglycol polymers, nitrated **6 E279**
- Polyhydric alcohols **8 P341–P342**
 butanetriol **2 B370–B371**
 iso-butanetriol **2 B371–B372**
 desoxyinositol **3 D91–D92**
 diglycerol **5 D1261**
 dipentaerythritol **5 D1407–D1413**
 dulcitol **5 D1567–D1568**
 erythritol **5 E123–E125**
 glucose **6 G83–G84**
 glycerol **6 G87–G93; 8 P342**
 hydrocellulose **7 H213**
 mannitol **8 M13–M16**
 methyl glycoside and its tetranitrate **8 M106**
 methyl trimethylolmethane **8 M116–M118**
 metriol **8 M120–M122**
 pentaerythritol **8 P81–P125**
 phloroglucinol **8 P248–P249**
 polyvinyl alcohol **8 P354**
- Polyhydrogen cyanide **8 P342–P343**
- Polymerization, violent **8 P343, P344–P345**
- Polymerized acetaldehyde see Paraldehyde **1 A14–A15**
- Polymerized alcohols **8 P343**
- Polymerized allyl type alcohols **1 A135–A136; 8 P343**
- Polymerized formic aldehyde see Formaldehyde polymers **6 F164–F165**
- Polymerized glycerin **8 P343**
- Polymer of 1-chloro-1-nitroethylene **3 C256**
- Polymers, expl **8 P346**
- Polymers, nitro- **8 N138–N157**
- Polymers of dextrose **5 D116**
- Polymethylmethacrylate (Lucite, plexiglas or PMMA) **8 P346–P348**
- Polynitramides **8 P348**
- Polynitroamines **8 P348**
- Polynitrocellulose see Cellulose nitrates **2 C100–C126**
- Polynitro derivs of abietic acid **1 A3**
- Polynitrodiamides **5 D1125**
- Polynitrodiphenylmethanes see Diphenylmethane **5 D1464–D1466; 8 P348**
 2,2',4,4',6,6'-hexanitrodiphenylmethane **8 P348**
- Polynitrostilbenes see Nitrostilbene; HNS **5 D1454–D1457; 7 H126**
- Polypropylene **8 P348–P349**
- Polystyrene **8 P349–P350**
- Polysulfide polymers **8 P350–P351**
- Polytetrafluoroethylene (teflon) **8 P351–P352**
- Polythiocyanogen **8 P352–P353**
- Polytropic (detonation) equation of state **4 D290**
- Polyurethanes **8 P353**
- Polyvinyl acetate **8 P353–P354**
- Polyvinyl alcohol (PVA) **8 P354**
- Polyvinyl chloride **8 P354–P355**
- Polyvinyl nitrate (PVN) **8 P356–P358**
- Ponzio reaction **8 P358–P359**
- Popped corn **8 P359**
- “Popping” **8 P359**
- Poseidon **8 P359**

- Potassium 8 P359**
Potassium-aluminum alum 1 A156
Potassium azide 1 A594–A596
Potassium bifluoride 6 F145
Potassium borofluoride 6 F146
Potassium chlorate 2 C190–C197
Potassium chloride 3 C240
Potassium chlorite 3 C246
Potassium-chrome alum 1 A156
Potassium dichromate 3 C284–C287
Potassium dinitrobenzofuroxan (KDNBF) 2 B68
Potassium dinitroethane see 1,1-Dinitroethane 6 E164
“Potassium” Dynamites 8 P359
Potassium ethylenedinitramine 6 E244
Potassium fluoride 6 F146
Potassium fluosilicate 6 F146
Potassium fulminate 6 F223
Potassium hydrogen acetylide 1 A79
Potassium-iron alum 1 A156–A157
Potassium isopurpurate 7 I137
Potassium methylnitramine 8 M110
Potassium nitrate 8 N34–N36
Potassium nitride 8 N101; see also Potassium azide 1 A594–A596
Potassium nitrite 8 N108
Potassium nitroethane 6 E146
Potassium oxalate 8 O30
Potassium oxide 8 O49
Potassium-silver fulminate 6 F223
Potassium tetrachromate 3 C289
Potassium trichromate 3 C288
Potatomeal or potatopulp expls 8 P360
Pot de feu see Cannon 2 C26
Potential 1 XX
- Potentite 8 P360**
Poudre B (propints) 1 A395
Powder-air explns and detonations 8 P360–P361
Powder bags see Cartridge bags 2 C77
Powder, Black see Black Powder 2 B165 ff
Powder chamber pressure measurements see Chamber pressure 2 C147
Powder explns see Coal dust; expln hazards from its uses 3 C359; Dust explns 5 D1578; Powder-air explns and detonations 8 P360–P361
Powder metallurgy 8 P361–P363
Powder cartridge 8 P363–P364
Power of expls 1 XX; 8 P364–P366
“P” (pebble powder) 8 P1
Praepositer 8 P366
Precession 8 P366–P367
Preisenhammer expls 8 P367
Premature explns 6 E380–E383; 8 P367
Premature explns in shooting wells 6 E383
Premature firing of rounds 6 E383
Preparation (and manufacture) of Ammonium Nitrate 1 A313–A318, A340
Preparation of ammines 1 A276
Preparation of Ammonals 1 A288
Preparation of nitrometer for standardization and tests on AN 1 A373–A374
Pressure and its measurement in ordnance 8 P367
Pressure-bar apparatus of Hopkinson see Hopkinson’s pressure-bar apparatus 1 XVI
Pressure, detonation 8 P367–P370
Pressure effect of expls see Blast effects in air, earth and water 2 B180–B184
Pressures, gun 8 P370
 , for all tubes and barrels 8 P370
 , for cannon tubes 8 P370–P371
 , for recoilless rifle tubes 8 P371

- Pressure, influence of on combustion of proplnts
see Burning and burning characteristics of
proplnts for artillery weapons and small arms
2 B346 ff
- Pressure, influence of on decomposition of expls
see Decomposition of expls 3 D23–D25
- Pressure measurements in closed bombs and
weapons see Closed bomb . . . measuring
pressures . . . 3 C330–C345
- Pressure of gages developed on combustion of
proplnts or expls 1 XX see Burning and
burning characteristics of expls, including
experimental procedures 2 B343–B346;
Burning and burning characteristics of
proplnts, experimental procedures
2 B349–B350
- Pressure of gases developed on expln or
detonation (tests) 1 XX see Blast meters
2 B214–B215; Closed bomb (or vessel) and
instruments for measuring pressure developed
by expls or proplnts 3 C330–C345;
Detonation (and expln) experimental
procedures 4 D299 ff
- Prilled AN see AN 1 A314, A315, A317, A340,
A354 ff
- Primacord see Cord, detonating; Cordeau fuse or
detonating fuse 3 C529–C531; 8 P372
- Primary expls see Initiating expls 7 I105–I106
- Primary expls, initiating efficiency see
Initiating efficiency of primary expls 1 XVIII
- Primer, definition 4 D774
- Primers 8 P372–P387
 , introduction-history 8 P372–P373
 , mechanical initiators 8 P373–P386
- Primers and igniters for initiating mortar proplnts
and description of some mortar projectiles
4 D797
- Primers for igniting proplnts in cartridge bags
used in separate-loading ammunition 4 D795
- Primers, military 4 D774
- Primers, nonmilitary 4 D734
- Primers, small arms 4 D775
- Primers used in demolition charges and in land
mines 4 D797
- Prism powder see Black Powder 2 B167; 8 P387
- Product characteristic (Fr) see Characteristic
product of Berthelot 1 IX
- Products, detonation 8 P387–P391
 detonation equilibria 8 P387–P389
 detonation product compositions, theoretical
 8 P389–P390
 “measured” product compositions
 8 P390–P391
- Progressite 8 P391
- Progressites 8 P391
- Projectiles see Ammunition 1 A383–A391
- Projectiles used in cannons and howitzers 4 D810
- Projectiles used in mortars 4 D829
- Projectiles used in recoilless rifles 4 D829
- Projectiles, US military specifications listing
8 P392–P396
- Promethees (Fr) see Explosifs 03 6 E363
- Proof 8 P397
- Propagation, backward wave 4 D143
- Propagation of detonation see Ability to
propagate detonation 1 VII
- Propagation test see Gap test 1 XIV–XV;
4 D397–D399; 6 G13–G14; Influence tests
7 I98–I100
- Propane and derivs 8 P397–P398
 1,1-dimethylol-1-nitropropane dinitrate
 8 P397
 1,3-dinitro-2,2-dimethylpropane 5 D1368
 dinitropropanes 8 P397–P398
 nitropropanes 8 P397
- Propanediols and derivs 8 P398–P400
 2-(3',5'-dinitrophenyl)-2-nitro-1,3-propanediol
 8 P400
 1,3-propanediol 8 P400
 propanediol dinitrates 8 P398–P400
- 1-Propanol and derivs 8 P400–P401
 1,3-diazidoisopropyl alcohol 8 P400
 1,3-dinitramino-2-propanol nitrate
 8 P400–P401

- 1-Propanol and derivs (cont'd)
 dinitropropanols 8 P400
 propanolamines see Aminopropanols 1 A436
 propanolanilines see Anilinopropanols 1 A436
- Propargyl alcohol 8 P401
- Propargyl bromide 8 P401
- Propellant actuated devices (PAD's) 2 C70—C72
- Propellants, solid 8 P402—P473
 , brief summaries of circa 1978 literature on 8 P455—P471
 , chemical characteristics and performance 8 P430—P455
 , history of 8 P403—P406
 , introduction to 8 P402—P403
 , physical characteristics of representative proplnts 8 P422—P430
 , production methods of representative proplnts 8 P420—P422
 , representative types and their uses 8 P406—P420
- Propene and derivs 8 P473—P475
 aminopropenes 1 A253—A254
 3-azido-1-propene see Allylazide 1 A137
 3-bromopropene see Acrylonitrile 1 A97
 chloropropenes 8 P474—P475
 1,3-diazidopropen-(1) 8 P473
 diazopropene 5 D1173
 3-nitropropene 8 P474
 nitropropene polymers 8 P473—P474
 1-phenyl-2-nitropropene-(1) 8 P474
 propenenitrile see Acrylonitrile 1 A97
 1,1,1-trichloro-3-nitropropene-(2) 8 P475
- Propen-2-en-1-ol 8 P475
- Prop-2-en-1-thiol 8 P475—P476
- Propergols see Liquid proplnts 7 L34—L44
- Properties of Ammonium Nitrate 1 A311—A313, A318—A334
- Properties of detonation processes see Detonation, explosion 4 D137—D732
- Properties of expl metal ammines (tables A to F) 1 A277—A282
- α -Propiolactone 8 P476
- Propiolic acid 8 P476
 2-nitro-phenyl-propiolic acid 8 P476
- Propionaldehyde and derivs 8 P476—P477
 α,β,β -trinitro-propionaldehyde-anil (Ger) 8 P477
 α,β,β -trinitro-propionaldehyde, dipotassium salt of 8 P476—P477
 α,β,β -trinitro-propionaldehyde methylimide 8 P477
- Propionamide 8 P477
 sodium propionbromoamide 8 P477
- Propionates and derivs 8 P477
 [2-nitro-ethyl]-propionate 8 P477
 [1-nitromethyl-2-methyl-propyl]-propionate 8 P477
 [2-nitro-propyl]-propionate 8 P477
- Propionic acid and derivs 8 P477—P478
 β -azido propionic acid 8 P478
 azido propionic acid azides 8 P478
 β,β -dinitro-propionic acid 8 P478
 α -nitro propionic acid 8 P478
 propionic nitrile see Ethyl cyanide 6 E223
 3,3,3-triodopropionic acid 8 P478
- Propionyls and derivs 8 P478—P479
 bis- $[\alpha(?)$ -bromopropionyl]-amine 8 P478
 3-pentanone 8 P478
 N-propionyl-dimethylsulfinimin-hydrochloride 8 P479
 propionyl nitrite 8 P479
- Propulsive force 1 XXI
- 2-Propyl acetate, 1,1,1-trinitro 8 P479
- Propyl acrylate 8 P479
 1,1,1-trinitro-2-propyl acrylate 8 P479
- n- and iso-Propylamine and derivs see Aminopropanes and derivs 1 A250—A251
- Propyl aniline and derivs 8 P479—P480
 N-propyl-N,2,4,6-tetranitro-aniline 8 P479
 2,4,6-trinitro-N-(isopropyl)-aniline 8 P479
 2,4,6-trinitro-N-(isopropyl)-N-nitraniline 8 P480
- Propylene-oxo-ozonide 8 O72
- 5-iso-Propyl-hydantoin acid azide 8 P492
- Propyl isopropylether, 3,3,3-trinitro 8 P492
- Propylmalonylazidic acid 8 P480
- Propyl malonic acid diazide 8 P480
- n-Propyl nitrate (NPN) 8 P481—P484

- iso-Propyl nitrate (IPN) 8 P484–P491
 2-nitro isopropyl nitrate 8 P484
- Propyl nitrites, n- and iso- 8 P491
- Propyl nitrolic acid 8 N135
- Propylene dinitramine (PDNA) see
 Diaminopropane 5 D1143
- Propyleneglycols and derivs see Glycols
 6 G112–G114; 8 P493
 3-azido-1,2-propyleneglycol dinitrate 8 P493
 di [2,2-dinitro-1,3-propyleneglycol]-trinitro
 butyrate 8 P493
- Propylene oxide 8 P493
- Propyleneoxozonide 8 P494
- bis-Propylene pseudonitrosite 8 P494
- iso-Propylidene-dicyclohexylidene-triperoxide
 2 B144
- iso-Propylidene-2,4,6-trinitrophenylhydrazine
 8 P494
- Propyl-[2,4,6-trinitro-phenyl]-ether 8 P480
- Propyne 1 A140 see Methyl acetylene
 8 M94, P494
- Prosperit V 8 P494
- Proteins, nitrated 8 P494
- Protol see Fermentol 6 F14
- Proving ground (PG) 8 P494
- Proximity fuze 4 D918–D921
- “PRP” wax 8 P495
- PTX-1 8 P495
- PTX-2 8 P495–P496
- Pudrolithe 8 P496
- Pullivitz expl 8 P496
- Pulvarent ammonium Dynamite 8 P496
- Pulverin 8 P496
- Pulvis fulminanx 8 P496
- Punch test for expls see Brisance test methods
 2 B299
- Punshon expl 8 P496
- PVA-4 8 P497
- PW 8 P497
- Pyrazole see 1,2-Diazole and derivs 5 D1165
- Pyridine and pyridinium compounds
 8 P497–P499
 pyridine chlorate 8 P498
 ibid, complexes of metallic permanganates
 8 P498–P499
 ibid, compounds with metallic salts 8 P498
 ibid, perchlorate 8 P498
 ibid, picrate 8 P498
- Pyrido-1',2':4,5-tetrazole 8 P247
- 3-Pyridyldiazonium fluoroborate 5 D1170
- Pyrimidinetetrone 1 A134
- “Pyro” 8 P499
- Pyrocatechol see Dihydroxybenzene 5 D1270 ff
- Pyrocellulose see Pyrocellulose, pyro or
 pyrocotton 2 C105 ff
- Pyroclok 8 P499
- “Pyrocollodion” powder 8 P499–P500
- Pyrocore 4 D763; 8 P500
- Pyrocoton 8 P500
- Pyrodialites 8 P500–P501
- Pyrofulmin 6 F223
- Pyrofuze 8 P501
- Pyrogels 8 P501
- Pyrogen igniter 8 P501
- Pyroglycerina (Ital) 6 G99; 8 P501
- Pyrolithe 8 P501
- Pyronite 8 P501
- Pyronitrines 8 P501
- Pyronome of De Tret 8 P502
- Pyropaper 8 P502
- Pyrophoric incendiary agents 8 P502–P504
 depleted 8 P503–P504
 new incendiary agents 8 P504
 , white phosphorus 8 P502
 , Zr 8 P502–P503
- “Pyro” powder 8 P504

- Pyrotechnics 8 P504–P526
 , advances in pyrotechnics 8 P518–P520
 , colored and white smoke 8 P507–P508
 , delays and fuses 8 P512–P515
 , flares and signals 8 P505–P507
 , igniters and initiators 8 P515–P517
 , incendiaries 8 P510–P512
 , introduction 8 P504–P505
 , photoflash compositions 8 P515
 , the literature of pyrotechnics 8 P510–P521
 , tracers and fumers 8 P508–P510
- Pyrotechnic ammunition 1 A384 see
 Pyrotechnics 8 P505–P517
- Pyrotechnic items, igniter compositions for
 4 D774
- Pyrotechnics, delay trains used in 4 D872
- Pyrotechnics, ignition train used in 4 D759
- Pyrotechnics, primary initiation, first fires,
 igniters and starters used in 4 D760
- Pyrotolites 8 P526
- Pyroxalam 8 P526
- Pyroxyle 8 P526
- Pyroxylees 8 P526
- Pyroxylins 8 P526–P527
- Pyroxylite 8 P527
- Pyroxylol 8 P527
- Pyruvic acid 8 P527
 nitrophenylhydrazones; salts 8 P527
- Pyruvic alcohol same as Acetol 1 A33
- Pyruvonitrolic acid see Acetylmethylnitrolic
 acid 1 A84

Q

- QDX (SEX) same as 1-Aceto-3,5,7-trinitro-1,3,5,7-tetrazacyclooctane 1 A49–A50
- Quadrant, fire control 9 Q1
- Quail 9 Q1
- Quaker guns 9 Q1
- Qualified product 9 Q1
- Qualified product list 9 Q1
- Qualitative development requirements information (QDRI) 9 Q1
- Qualitative tests for ammonium nitrate 1 A369
- Qualitative analysis, Ammonals 1 A292–A293
- Quantity-distance (expl safety distance) 9 Q1–Q2
- Quantitative procedure for Ammonals used at PicArsn 1 A293
- Quantitative tests for ammonium nitrate 1 A369–A373
- Quarrycord 9 Q2
- Quaternary ammonium salts see Ammonium salts, Quaternary 1 A381
- Quebrachitol 9 Q2–Q3
 , pentantrate 9 Q2–Q3
- Queen gray recorder 9 Q3
- d-Quercitol 9 Q3
 , pentantrate 9 Q3
- Quickmatch 8 M40–M41
- Quickmix 9 Q3–Q4
- Quickness 9 Q4
- Quickness coefficient of proplnts 3 C390–C391
- Quickness, relative 9 Q4
- Quickness of burning proplnt, determination 1 XXI see Coefficiente de vivacite des poudres 3 C390–C391
- Quinalino-diazido-copper 9 Q4
- Quinan test 1 XXI; 3 C493–C494
- Quinan, William Russell 9 Q4–Q5
- Quinido-tetrazido-copper see Copper (II) quinidine azide 3 C518; 9 Q5
- Quinol and derivs see Hydroquinone 7 H227–H228
- Quinoline 9 Q5–Q6
 , salts and addition compounds 9 Q5–Q6
- Quinoline chlorate 2 C197
- Quinone and derivs see Benzoquinone 2 B79
- Quinone, azido and azido halogen derivs of, see Benzoquinone 2 B80
- Quinone diazides 9 Q6
- Quinone, nitro and other derivs of, see Benzoquinone 2 B80–B81
- Quinone, substituted diazonium derivs of, see Benzoquinone 2 B81–B83
- Quinonedimine and derivs see Benzoquinonedimine 2 B83–B84
- Quinone dioxime and derivs see Benzoquinonedioxime 2 B83–B84
- Quinonedioxime peroxide see Benzofuroxan 2 B86
- Quinoneimine and derivs see Benzoquinoneimine 2 B84
- Quinonemonoxime and derivs see Benzoquinonemonoxime 2 B85–B86

- Rabinet 9 R1
- Rabut expls 9 R1
- Rack-a-rock 9 R1
- Rachite III & IV 3 C558
- Raczynski process 9 R1–R2
- Radar 9 R2–R4
- Radial band pressure 9 R4
- Radial expansion 9 R4
- Radiation effects on expls, proplnts, and pyrots 9 R5–R75
- radiation effects on expls 9 R5–R53
 - , bibliography 9 R67–R75
 - , computational methods 9 R67
 - , introduction 9 R5
 - radiation effects on proplnts and propulsion 9 R53–R66
 - ibid on pyrotechnics 9 R66–R67
- Radiation gauging in energetic materials 9 R76–R103
- , charged particle gauging 9 R76–R77
 - , gamma-ray gauging 9 R77
 - , gamma-ray scattering 9 R79–R82
 - , gamma-ray transmission 9 R77–R79
 - , neutron gauging 9 R82–R84
 - , radiation gauging 9 R76
 - , specific applications of radiation gauging 9 R84–R103
- Radioactive tracers (use in energetic materials) 9 R104–R113
- , adsorption from solutions of high molecular weight compounds on the surfaces of powdered expls 9 R109
 - , adsorption of carbon-14-labeled STAB by HMX 9 R109
 - , analysis of HMX/RDX mixtures by isotope dilution 9 R109–R110
 - , inspection of hand grenade fuse delay element by a radioactive tracer technique 9 R107–R108
 - , non-destructive test method for defects in proplnt rocket motors 9 R105–R106
 - , proplnt motion studies in a 37-mm gun 9 R104
 - , radioactive proplnt gauge 9 R106–R107
 - Radioactive tracers (use in energetic materials) (cont'd)
 - , radioactive tracers in cratering experiments with Comp C-4 9 R107
 - , radioactive tracer method for detecting the presence of firing-pin supports in fuze assemblies 9 R112
 - , radiometric determination of homogeneity of a multicomponent pyrotechnic mixture 9 R111–R112
 - , recovery of ammunition items using a radio-tracer technique 9 R112
 - , study of inert carrier proplnt mixing process 9 R105
 - , study of solid proplnt mixing 9 R104–R105
 - , the effects of UV light on TNT in aqueous solution 9 R111
- Radio proximity or VT fuze 4 D918–D921
- Radius of rupture in underground blasts see Blast effects in earth 2 B182
- Radoubage des poudres (Fr) 9 R113
- Rafale (Fr) 9 R113
- Raibun (enka) see Jap expls, ammunition and weapons 7 J46
- Raiko see Jap expls, ammunition and weapons 7 J46
- Railroad or highway fusee 9 R113–R114
- Railroad torpedo 9 R114
- Railway mount 9 R114
- Ram-jet engine igniter 4 D773
- Randalite 9 R114
- Randamite 9 R114
- Randites 9 R115
- Raney nickel 9 R115
- Range (rg) 9 R115–R116
- angle 9 R115
 - calibration 9 R115
 - correction 9 R115
 - correction board 9 R115–R116
 - determination 9 R116
 - deviation 9 R116
 - difference 9 R116

- Range (rg) (cont'd)
 firing 9 R116
 ladder 9 R116
- Rankine-Hugoniot (detonation) equation of state
 4 D278–D281, D291 ff; D604 ff
- RAP-14 9 R116
- Rapier 9 R116
- Rarefaction effect see Blast effects in air
 2 B180
- Rarefaction wave 4 D500–D502
- Raschig weisspulver and raschit 9 R117
- Rate of detonation test see Detonation rate test
 1 X; Experimental determination of detona-
 tion velocity 4 D632–D640
- Rationite (Fr) (or D-stoff) see Dimethylsulfate
 5 D1373
- RATO 1 A497; 9 R117
- Rauchlose pulver 9 R117
- Rave expl 9 R117
- Rayon 9 R117–R119
- Rayon, nitration of 9 R119
- RCP 9 R119
- RDB cordite 3 C532
- RDX 9 R120–R146
 , analytical methods 9 R140–R141
 , characteristics of steady detonation
 9 R124–R127
 , chemical reactions of and radiation effects
 on 9 R123–R124
 , combustion and DDT 9 R133–R135
 , decomposition and kinetics 9 R136–R140
 , detonators 9 R143
 , initiation behavior 9 R128–R133
 , military specification 9 R143–R144
 , physical properties of 9 R120–R121
 , thermal and thermochemical properties
 9 R122–R123
 , toxicity 9 R142–R143
 , waste disposal 9 R141–R142
- Reactivity tests see Compatibility of expls with
 other substances 3 C461
- Reclamation of energetic material components
 from ordnance ammunition 9 R146–R150
 , expls 9 R147 (table); R149
 , proplnts 9 R148 (table); R149
 , pyrots 9 R149; R149 (table)
- Recoilless gun 2 C28
- Recoilless rifle projectile fuzes 4 D921
- Recoilless rifles 9 R151–R152
- Reddy fox or water snake 5 D1113; 9 R152
- Redeye 7 I96; 9 R152–R153
- Red fuming nitric acid 8 N89–N99; see
 Nitration N40 ff
- Red gum see Gum-tree 6 G187
- Red iron test see Sensitivity to flame, heat,
 sparks, etc 1 XXII–XXIII
- Redoutable 9 R154
- Red phosphorus 8 P251–P253
- Red sod 9 R154
- Red star 9 R154
- Red top 9 R154
- Redundancy 9 R154
- Reefing line cutter see Proplnt actuated devices
 2 C71
- References (circa 1969) on detonators, primers,
 fuses, fuzes, igniters; viz, books, articles,
 patents, PATMs and PATRs
 4 D1023–D1060
- Regulations and tests for permissible expls, US
 Govt 3 C369–C370, C375–C377
- Regensburger's expl 9 R154
- Register 9 R154–R155
- Regulus 9 R155
- Reichen powder see Melland powder
 8 M56; 9 R155
- Reid and Earle expl 9 R155
- Reinsdorf explosion 9 R155
- Reintri 9 R155
- Relais, explosif pour (Fr) 9 R155

- Relative percussive force of an expl see
Percussive force of an expl 1 XIX; 8 P178
- Relative propulsive force of an expl see
Propulsive force of an expl 1 XXI
- Relay 9 R155–R156
- Relays and relay detonators 4 D869
- REM 9 R156
- Rendering safe procedure 9 R156
- Rendite 9 R156
- Renovation of ammunition 9 R156–R157
- Reprise d'humidite, Essai (Fr) see Hygroscopicity
tests 1 XVI; 7 H251–H254
- Requa battery 9 R157
- Residee (Fr) 9 R157
- Resin 9 R157
- Resina explosiva (Span) 9 R157
- Resinates 9 R157–R158
- Resins, combustible 9 R158
- Resistance to detonation of an expl see
Detonation, resistance to 4 D508–D510
- Resistance to heat test 1 XXI
- Resistivity (of expls) 5 D1221
- Resolution 9 R158–R159
- Resonance burning 9 R159
- Resorcinate, 2,4-dinitroso metal salts see
Resorcin, 2,4-dinitroso 9 R159–R160
- Resorcinate, lead dinitro 9 R160
- Resorcinate, 2,4,6-trinitro, lead hydroxide
5 D1277–D1288
- Resorcinate, 2,4,6-trinitro, lead salt containing
methylcellulose 4 D1050–D1051
(Ref Ad 157)
- Resorcin, dinitro (Ger) see Dinitro derivs of
dihydroxybenzene 5 D1273–D1274
- Resorcin, 1,4-dinitroso (Ger) 9 R159–R160
- Resorcinic acid 9 R160
- Resorcin, nitro (Ger) see Mononitrodihydroxy-
benzene 5 D1271
- Resorcinol see Dihydroxybenzene
5 D1270; 9 D160
- Resorcinol, derivs of see Dihydroxybenzene
5 D1270–D1288
- Resorcinol, 2,4-dinitro, di-lead chelate 9 R160
- Resorcinol, 5-methyl, 2,4-dinitro 9 R160–R161
- Resorcinol, 5-methyl, 2,4,6-trinitro 9 R161
- Resorcinol, trinitro-di (β -nitroso) ethyl ether
5 D1288
- Resorcinol, trinitro, explosibility of see
Trinitro derivs of dihydroxybenzene 5 D1277
- Resorcinol, trinitro-, (bis) triethyl lead see
Bis (triethyl) lead styphnate 2 B160; 9 R161
- Resorcin, tetranitro (Ger) see 2,4,5,6-Tetra-
nitroresorcinol 5 D1288
- Resorcin, tetranitro, athylather (Ger) see
Monoethylether deriv of 2,4,5,6-tetranitro-
resorcinol 5 D1288
- β -Resorcylate, lead 9 R161
- β -Resorcyclic acid see Dihydroxybenzoic acid
5 D1288
- β -Resorcyclic acid, 3,5-dinitro see 3,5-Dinitro-
2,4-dihydroxybenzoic acid 5 D1289
- α -Resorcyclic acid, 4-nitro see Nitro derivs of
dihydroxybenzoic acid 5 D1289
- β -Resorcylonitrile, 3,5-dinitro see
2,4-Dihydroxybenzonitrile 5 D1289
- Resorzinat, bleitrinitro or bleistyphnat (Swiss)
9 R162
- Resorzin, trinitro- (Swiss), styphninsaeure or
oxypikrinsaeure (Ger) 9 R162
- Rest proof 9 R162
- Retene-3-diazo-4-oxide, 9-nitro 9 R162
- Retonation 9 R162
- Retonation caused by the reflection of divergent
waves in detonation 4 D510
- Retrofit 9 R162
- Revolvers and self-loading pistols 9 R162–R165
pistol revolver 9 R162–R164
self-loading pistols 9 R164–R165

- Rexite 9 R165
 Rex powder 9 R165
 Reynolds powder 9 R165
 RF energy, effect on weapon systems
 9 R165–R166
 Rhamnose 9 R166
 , tetranitrate 9 R166
 , trinitrate 9 R166
 Rheinbote 9 R166
 Rheinische Dynamit 9 R166
 Rheintochter 9 R166
 Rhexite 9 R166–R167
 Rhonit 9 R167
 Ricinolein 9 R167
 , nitrate 9 R167
 Ricker and Spence powders 9 R167
 Rickmers' expls 9 R167
 RIDE 9 R167–R168
 Rifle 9 R168–R172
 Rifle bullet impact and sensitivity test see
 Bullet impact sensitiveness test
 1 IX; 2 B332–B334
 Rifleite 9 R172
 Rifle powder of Muraour (Fr) 9 R172
 Rifling 9 R172–R173
 Rimfire cartridge 9 R173
 Rinckenbach, William H. 9 R173
 Riot control, chemical reagents for
 9 R173–R174
 RIPE 9 R174
 Ripping Ammonal 9 R175
 Rippite 9 R175
 Ripplene see Boyd powders 2 B259
 Rivets, expl see Expl rivets 6 E442–E445
 RLG powder 9 R175
 Robandis powder 9 R175
 Robert's powder 9 R175
 Robertson, Sir Robert 9 R175
 Robin Hood Powder Co 9 R175
 Robins, Benjamin 9 R175
 Roburites 9 R175–R176
 Roca's expls see Lithoclastites 7 L45
 Roca's fuse 9 R176
 Rock breakage using expls see Expl performance,
 comparison of two methods for its evaluation
 6 E424–E429
 Rocket 9 R176–R177
 Rocket ammunition 1 A384 see Rocket
 9 R176–R177; Rocket-assisted projectiles
 9 R177
 Rocket-assisted projectiles (RAP) 9 R177
 Rocket fuels and proplnts see Liquid proplnts
 6 L34–L44; Proplnts, solid 8 P402 ff
 Rocket launcher, 3.5 inch 7 I95
 Rocket launchers 2 C28–C29; see Rocket
 9 R176–R177
 Rockeye 9 R178
 Rodman, Thomas Jefferson 9 R178
 Rodman guns 9 R178
 Roger powder 9 R178–R179
 Rohtri 9 R179
 Roland 9 R179
 Romite 9 R179
 Romochki's powder 9 R179
 Romperit 1 9 R179
 Rompe-roca 9 R179
 Ronsalite 9 R179
 Roos' expls 9 R179
 Roseburg, Oregon explosion 9 R179–R180
 Rosenthal's expl 9 R180
 Roseocobaltiammine chlorate see Co 14, aqua-
 pentaminecobalt (III) chlorate monohydrate
 1 A279 (table C)

- Roseocobaltiammine perchlorate see Co 15,
aquapentammine cobalt (III) perchlorate
monohydrate 1 A279 (table C)
- Roseocompounds 9 R180
- Rosette grain see Cannon proplnt 2 C30—C31
- Rosin see Colophony 3 C403—C404
- Ross and Cairney expl 9 R180
- Rosslin giant powder 9 R180
- Rosslin's blastite see Blastite 2 B214
- Rosslin powders 9 R180
- Rotary drums 5 D1556—D1560
- Rotating band 9 R181
- Rotating drum camera see Cameras, high-speed
photographic 2 C14; Chronographs 3 C311
- Roth, W.A. 9 R181
- Rotherham test see Coal mining expls, testing
for permissibility 3 C372
- Rotten 9 R181
- Rotter impact test see FI test 1 XII; 6 F39—F40;
Impact, initiation of expln by 7 I37 ff
- Rouge (red) Dynamite 9 R181
- RPC/12 9 R181—R182
- R-salt 3 C630—C633
- R.S.P. gel (Brit) 9 R182
- Rubber bonded expl see PBX 8 P60—P77
- Rubidium and derivs 9 R182—R183
rubidium acetylides 1 A79
Rb azide 1 A596—A597; 9 R182
Rb dinitrobenzofuroxane (RbDNBF)
9 R182—R183
Rb fluoride 6 F146
Rb hydride 9 R183
Rb salicide 9 R183
- Run-down method 9 R183
- Ruptol B 9 R183
- Russelite 9 R183
- Russian coal mining expls see Coal mining expls,
nonpermissible 3 C441; *ibid*, permissible
3 C454; 9 R183
- Russian expls and related items 9 R184—R203
, a listing of, from "A" to "Zhirov's expls"
9 R184—R199
, references for 9 R199—R203
- Russkay a smes' 1 A383
- Ruthenium tetroxide 9 R203

- S1 and S2 9 S1
- S.1 (Dynamite) 9 S1
- Sabot (Fr) 9 S1–S4
 , applications 9 S2
 , history of use 9 S2–S4
- SABRE method 9 S4
- Sabulita see Spanish commercial expls of non-permissible type 3 C442
- Sachets antilueurs (Fr) see Argol 1 A480
- SADARM 9 S5
- Safeguard 9 S5–S6
- “Safety” blasting powders 9 S6
- “Safety compound” 9 S6
- “Safety expls” 9 S6
- “Safety” gunpowder 9 S6
- Safety in the energetic materials field 9 S6–S29
 industry safety 9 S10–S14
 lab safety 9 S7–S10
 , application of computer programming to hazard analysis 9 S21–S22
 , evaluation of new expls and expl mixtures 9 S16–S21
 , experimental hazard assessment 9 S22–S23
 , introduction to 9 S6–S7
 , specific hazards 9 S14–S16
 , thermal stability tests 9 S23–S25
 , threshold initiation studies 9 S25–S27
- “Safety jelly” 9 S29
- Safety match 8 M39–M40
- “Safety nitro” powder 9 S29
- Safety pin 9 S29–S30
- Sagger 9 S30
- Saggio alla Berta see Impact sensitivity test 1 XVII; Berta apparatus 2 B104
- Sainfoin nitrate 9 S30
- Saint Helen’s powder (Brit) 9 S30
- Saint Marc powder (Brit) 9 S30
- Salicylaldehyde and derivs see Hydroxybenzaldehyde and derivs 7 H233
- Salicylic acid and derivs see Hydroxybenzoic acid and derivs 7 H236–H238; see also Ethylsalicylate and derivs 6 E329, E330; 9 S30–S33
 Ba 3,5-dinitrosalicylate 9 S32–S33
 dipotassium 3,5-basic Cu salicylate 9 S31–S32
 5-diazo-salicylic acid 9 S32
 dinitrosalicylate 9 S33
 lead salicylate 9 S32
 US military specification on salicylic acid 9 S30–S31
- Salite see Bergenstrom (expl) 2 B102; 9 S33
- Salted weapon 9 S33
- Salts and complexes of N-methylaniline with inorganic compounds 8 M98
- Salts and complexes of N-methylaniline with organic compounds 8 M98–M99
- Salts and other derivs of benzoic acid-2-diazonium hydroxide 2 B75
- Salts and other derivs of benzoic acid-3-diazonium hydroxide 2 B75–B76
- Salts and other derivs of benzoic acid-4-diazonium hydroxide 2 B76
- Salts of aniline with inorganic acids 1 A406–A407
- Salts of aniline with organic compounds 1 A407
- Salvage of ammunition 9 S33
- Salvo, project 9 S33
- Salvo squeezebore (SSB) 9 S34
- SAL-X powder mixtures 9 S34
- Samsonites (Brit) 9 S34
- “Sand bullets” 9 S34–S35
- Sand test or sand crushing test 1 XXI–XXII; 9 S35
- Sanlville and Laigant powder 9 S35
- SAP see Semi-armor-piercing bombs 4 D933
- Sapojnikoff, Aleksei Vassilievich 9 S35

- Sarin (GB) or trilon 46 see
Methylisopropoxyfluorophosphine oxide
5 D1309
- SAW 9 S35–S36
- Saxifragine (poudre de mine de Wynants) (Fr)
9 S36
- Sazonites 9 S36
- Sayers' expls 9 S36
- Scabbing 9 S36
- Scanning electron microscopy 8 M127–M128
- SC cordite see Cordite SC 3 C532
- Schaffer powder 9 S36
- Schatzmann plastic safety expls 9 S36–S37
- Scheelite 9 S37
- Schindler powder 9 S37
- Schiesswolle 8 see Hexamite 7 H85
- Schist oil 9 S37
- Schlieren method see Cameras, high speed
photographic 2 C15–C16
- Schlusseburgit 9 S37
- Schnud, Arnold 9 S37
- Schnebelin-Boilean powder see Chlorate expls
2 C206
- Schnebelin powder see Chlorate expls 2 C206
- Schneiderite (Fr) 9 S37
- Schneider ordnance 9 S37
- Schonbein, C.F. 9 S37–S38
- Schoneweg, M. 9 S38
- Schuler powder see Chlorate expls 2 C206
- Sculhof and Quirin 9 S38
- Schuckher 9 S38
- Schultz and Gehre expls 9 S38
- Schultze's expls and powders 9 S38–S39
- Schwab powder 9 S39
- Schwartz, H. 9 S39
- "Schwarzer" expls 9 S39
- SC proplnt see Cordite SC 3 C532
- SD NEO (Fr) 9 S39
- SD Ngl (Fr) 9 S39
- SDO 9 S39
- Sear 9 S39
- Seaweed 9 S39
- Sebacic acid and derivs 9 S40
sebacic acid diazide 9 S40
ibid esters 9 S40
- Sebastines (Swed) 9 S40
- Sebert chronograph see Chronographs 3 C317
(Ref 3)
- Sebomite see Chlorate expls 2 C206
- Second problem of ballistics 6 G197; 9 S41
- Secondary blasting 9 S41
- Secondary ethers of polyhydric alcohols 9 S41
- Secondary high expls 9 S41
- Securit see Hexanitrodiethylurea 5 D1255
- Securites 9 S41
- Sedorolite primary mixture 9 S41; see
Chlorate expls 2 C206 (Refs)
- Seismic prospecting 9 S42
- Selection of commercial expls and blasting agents
9 S42–S47
ammonia gelatines 9 S43
Blk Powder 9 S43
blasting agents 9 S43–S44
blasting gelatin or oil well expls 9 S43
criteria for selecting an expl 9 S46–S47
dry blasting agents 9 S44–S45
high density ammonia Dynamites 9 S43
liquid oxygen expls 9 S43
low density ammonia Dynamites 9 S43
military expls used in industrial operations
9 S43
permissible expls 9 S43
properties of commercial expls and blasting
agents 9 S45–S46
semigelatins 9 S43
slurry blasting agents 9 S45
straight gelatines 9 S43
straight NG Dynamites 9 S42–S43

- Selentique (poudre) (Fr) 9 S47
- Selenium 9 S47–S48
- Selenium nitride 8 N101
- Selenium tetrafluoride 6 F146
- Self-destruction (SD) 9 S48
- Self-loading pistols 9 R164–R165
- Semicarbazide and its salts 9 S48
 semicarbazide chlorate 9 S48
 ibid hydrochloride 9 S48
 ibid nitrate 9 S48
 ibid perchlorate 9 S48
- Semiconductor expl initiator 9 S48–S49
- Semifixed ammunition 9 S49
- Semi-gelatine expls 9 S49–s50
- Semipyrophoric metals 9 S50
- Sample plunger 9 S50
- Sengite 9 S50
- Sensibilite a l'amorce (Fr) see Essais d'explosifs
 5 E140
- Sensibilite au choc du mouton (Fr) see
 Essais d'explosifs 5 E139
- Sensibilite a la friction (Fr) see Essai a la friction
 5 E136
- Sensibilite a l'inflammation (Fr) see Combustion
 en tas conique 5 E138
- Sensibilite a l'onde explosive (Fr) see
 Transmission de la detonation a distance
 5 E140
- Sensitiveness of expls see Initiation 7 I106–I109
- Sensitivity measurements on detonator, primers,
 igniters and fuzes 4 D1078
- Sensitivity (sensitiveness) of expls, proplnts and
 pyrotechnic compositions tests 1 XXII see
 Detonation (and expln) experimental
 procedures 4 D299–D346; Initiation
 7 I106–I109
- Sensitivity to detonation by initiating agents see
 Sensitivity to initiation by detonators and
 boosters 1 XXII; Initiation 7 I106–I109
- Sensitivity to flame, heat, sparks, electrostatic
 discharges, etc 1 XXII–XXIII see Detonation
 experimental procedures 4 D299–D346;
 Initiation 7 I106–I109
- Sensitivity to initiation by primary expls,
 detonators and boosters tests 1 XXIII see
 Detonation experimental procedures
 4 D299–D346; 7 I106–I109
- Sentinel 9 S50–S51
- Separated ammunition 9 S51
- Separate loading ammunition 9 S51
- Seranine (Swed) 9 S51
- Sergeant 9 S51
- Serpentine powder 9 S51
- Service ammunition 9 S51
- Service des poudres et saltpetres (Fr) see
 Commission des substances expls 3 C460
- Service life see Life of guns 7 L14; 9 S51
- Service velocity 9 S51
- Servomechanisms 9 S52
- Setback acceleration 9 S52–S55
- Setting point determination 1 XXIII,
 A612–A613
- Setting ring 9 S55
- Settling rounds 9 S55
- Sevranites 9 S55
- Sevran-Livry, explosif de (Fr) 9 S55
- SEX same as 1-Aceto-3,5,7-trinitro-1,3,5,7-
 tetrazacyclooctane 1 A49–A50; see QDX
 9 Q1
- Shadow method in ballistics see Cameras, high-
 speed photographic 2 C16
- Shaped charge effect see Detonation, Munroe-
 Neumann effect 4 D442–D454; 9 S55–S56
- Shaped charge efficiency (test) 1 XXIII
- Sharp and Smith powder 9 S56
- Shattering effect 1 VIII–IX; see Brisance or
 shattering effect 2 B265–B300

- Shear pin 9 S56
- Sheathed expls see Commercial expls
3 C450–C459; Low energy detonating cord
7 L58; Primacord 8 P372
- Sheet expls see Detasheet flexible sheet expls
3 D99–D101; Flexible expls 6 F107
- Shelf life 9 S57
- Shell see Ammunition and weapons
1 A383–A391; Projectiles 8 P391–P396
- Shillelagh (SMGM-51A) 9 S57
- Shell filling or loading see Loading and
fabrication of expls 7 L46–L57
- Shell fragmentation see Subjects from
Fragmentation thru Fragment velocity
measurement 6 F180–F182
- Shellac see Gum lac 6 G187
- Shell impact sensitivity test 1 VII
- Shellite 9 S57
- Shimose 9 S57–S58
- Shipping commercial expls 9 S58
- Shobenyaku 1 A401
- Shock ionization in condensed media 7 I129
- Shock ionization of gases 7 I129–I132
- Shock-pass-heat-filter 4 D399
- Shock phenomena see Topics in 4 D515–D547
- Shock sensitivity of explosives 9 S58–S83
experimental methods 9 S61–S68
factors that control shock sensitivity
9 S68–S72
introduction 9 S58–S59
mechanism of shock initiation of homo-
geneous expls 9 S74–S75
mechanism of shock initiation of hetero-
geneous expls 9 S75–S82
review of shock phenomenon 9 S59–S61
shock initiation of deflagration 9 S82
shock sensitivity data 9 S72–S74
- Shock sensitivity test 1 XVII; 5 D1550–D1555
- Shokoladnyi porokh see Dymnyi porokh
5 D1582
- Short-delay blasting 9 S83
- Shrapnel 9 S83–S84
- Shrike (AGM-45A) 9 S84
- Shrinkage and cavitation in expl charges see
Loading and fabrication of expls 7 L46–L57;
Hot spots 7 H170–H175
- SH-salz see RDX 3 C614; 9 S84
- Shu mine 9 S84
- Sicherheitsdynamit 9 S84
- Sidewinder 9 S84
- Siemens' chronograph see Chronographs 3 C305
- Siemens' powder 9 S84–S85
- Sigenits 9 S85
- Signals, flare or smoke see Pyrotechnics
8 P505–P508
- Silanes and derivs 9 S85–S88
silane polysulfide polymers 9 S87
siloxanes 9 S86–S87
silylamines 9 S86
silyl azides 9 S86
triethylmonosilane 9 S86
trisilane 9 S86
- Silberazetylenid (Ger or Swiss) see
Silver acetylide 1 A79
- Silberazid (Ger or Swiss) see Silver azide
1 A597–A612
- Silberrad expls 9 S88
- Silberrad plastic expls see Nitrol 8 N135
- Silesia expls see Chlorate expls 2 C206;
Colophony 3 C403–C404
- Silesite 9 S88
- Silhouette test 3 C350
- Silica see Silicon dioxide 8 O49–O50
- Silica gel 9 S88–S90
- Silicates 9 S90–S93
Ca silicate 9 S90–S92
sodium silicate 9 S92–S93
- Silicides 9 S93–S96
Ca silicide 9 S93–S95
Ce silicide 9 S95
Li silicide 9 S95

Silicides (cont'd)

- Mg silicide 9 S95
- potassium silicide 9 S95
- Rb silicide 9 S95
- sodium-silicide 9 S95

Silicofluoroform 6 F146

Silicominol 9 S96

Silicon and derivs 9 S96–S101

- SiC 9 S99
- SiO₂ 8 O49–O50
- silicon-ferro alloy 6 F16–F17; 9 S99–S100
- silicon fluoride 6 F146–F147, see also
“The history of NG manufacture” 6 G100
- silicon fluorodinitro compounds 9 S100
- silicon nitride 9 S100
- silicon tetrazide 1 A597

Silicones 9 S102–S109

- polydimethyl siloxane 9 S107–S108

Silicon monoxide 8 O50–O51

Silk, nitrated 9 S110

Siloidina 8 N157–N162; 9 S110

Silver acetylides 1 A79–A82; 9 S110

Silver amide 1 A169–A170

Silver azide 1 A597–A601; 9 S110

- decomposition 1 A599
- expl properties 1 A598
- general properties 1 A598–A599
- preparation 1 A598
- uses 1 A599

Silver chlorate 2 C197

Silver chloride 3 C240–C241

Silver chlorite 3 C246

Silver cyanamide see Cyanamide and derivs
3 C581; 9 S110

Silver diketopiperazine 5 D1299

Silvered vessel test 1 XXIV

Silver fluoride 6 F147

Silver fulminate 6 F223–F225; 9 S111

Silver fulminate (SF) and telescopic mirrors
6 F224–F225

Silver imide 7 I34

Silver mucic acid diamide 8 M160

Silver nitride 8 N102

Silver nitrocyanimide see Cyanamide 3 C581;
9 S111

Silver oxalate 8 O30–O31; 9 S111

Silver perchlorate 8 P167

Silverdinitridooxosulfate (VI) 9 S111

Simplonits see Swiss commercial expls of
nonpermissible type 3 C444

Simpson expls 9 S111

Simulation 9 S111–S112.

- air burst simulator 9 S112
- artillery flash simulator 9 S112
- atomic expln simulator 9 S112
- boobytrap simulator 9 S112
- expl simulator 9 S112
- ground burst simulator 9 S112
- hand grenade simulator 9 S112

Sintered metal bullets 9 S113

Sipalin AOM 9 S113

Siperite 7 I177

Sismite see Tritamite 7 I118

Sixolite 9 S113

Sixonite 9 S113

Size, classification; size, particle see Particle
size measurement of solid proplnts, expls,
and pyrots 8 P18–P59

Sjoberg expls see Curds 3 C557

Skidmore & Hart (detonation) equation of state
4 D291

Skid test 4 D322–D324; 9 S113–S119

Slant range 9 S119

Slider 9 S119

Sliding-block friction test 9 S120

Sliding torpedo test see Torpedo friction test
6 F205–F206

Slow match 9 S120

SLUFAE 9 S120–S121

- Slurry expls 9 S121–S147
 slurry compositions 9 S125–S127
 , expl characteristics of 9 S127–S139
 , history of 9 S121–S122
 , introduction 9 S121
 , manufacture and uses of 9 S122–S125
 , patent list of 9 S139–S147
- Small arms ammunition 1 A383 see Small arms
 and small arms ammunition 9 S148
- Small lead block compression test see
 Compression tests 1 X; 3 C492–C494
- Small lead block compression test for detonators
 see Esop's test 1 XI
- Small lead block expansion test for detonators
 see Trauzl test 1 XXV–XXVI
- Small scale gap tests see Influence tests
 7 I98–I100; 9 S148
- "Smart" bombs 9 S148
- Smith's expls 9 S148
- Smoke, military see Pyrotechnics 9 P507–P508
- Smokeless powder see Proplnts, solid
 8 P402–P413
- "Smokeless powder Dynamite" 9 S148
- Smolianinoff 9 S148
- Snake 9 S148–S149
- Snake-holing 9 S149
- Snelling, Walter O. 9 S149
- Snyder expl 9 S149
- Soap, mercury fulminate indicating 9 S149
- Sobrero, Ascasio 9 S149
- Soda blasting powder 2 B172–B183; 9 S149
- Soda Dynamites 9 S150
- Sodatol 9 S150
- SOD formula 122 9 S150
- Sodium and its derivs see Pyrophoric incendiary
 agents 8 P502–P504; 9 S150–S153
 sodamide 1 A170
 sodium acetate 1 A29
 sodium acetylde see Monosodium acetylde
 1 A82
- Sodium and its derivs (cont'd)
 sodium-Al alum 1 A157
 sodium azide 1 A601–A619; 9 S150–S151
 sodium azido thiocarbonate 1 A634
 sodium borofluoride 6 F147
 sodium carbide 1 A82
 sodium carbonate and bicarbonate 2 C59–C60
 sodium carboxy methyl cellulose 2 C56; 9 S151
 sodium cellulose glycolate 3 C351
 sodium chlorate 2 C197–C200
 sodium chloride 3 C241
 sodium chlorite 3 C246
 sodium chromate 3 C282
 sodium cuprous fulminate 6 F225
 sodium decaborane see Boron hydride derivs
 2 B253–B255
 sodium dichromate 3 C287
 sodium fluoride 6 F147
 sodium fluorosilicate 6 F147
 sodium formate 6 F171
 sodium fulminate 6 F225
 sodium hydrazide 7 H189
 sodium hydrogen acetylde 1 A82
 sodium mercaptotetrazole 8 M58
 sodium mononitroresolsulfonate 3 C558
 sodium nitrate 8 N36–N38; 9 S151–S152
 sodium nitride 8 N102
 sodium oxalate 8 O31
 sodium oxide 8 O51
 sodium-5-oxy-1,5-azotetrazole 8 O55
 sodium perchlorate 8 P167–P168
 sodium peroxide 8 P191–P192
 sodium picramate 1 A242–A243
 sodium picrate 8 P238; 9 S152
 sodium propionbromoamide 8 P477
 sodium salt of nitropropylisonitramine
 8 P481
 sodium sulfide 9 S153
 sodium tetraborate see Borates 2 B247–B248
 sodium tetrachromate 3 C289
 sodium trichromate 3 C288
- Sodium azide 1 A601–A612
 absorption and emission of radiation 1 A605
 chemical reactions 1 A605–A607
 effects of radiation 1 A605
 expl properties 1 A605–A609
 manufacture of sodium azide 1 A603–A604
 preparation 1 A603
 properties 1 A602–A603
 structure 1 A603
 toxicity 1 A603–A604
 uses 1 A607–A608

- Sodium azide plant, analytical procedures
1 A612–A619
 anhydrous ammonium synthetic 1 A612
 colorimetric determination of sodium azide in
 aqueous ammonia 1 A617
 crude sodium azidoliquor 1 A616
 ferric nitrate 1 A613
 first clear liquor 1 A615
 first mother liquor 1 A613–A614
 lime treatment tank 1 A615–A616
 nitrous oxide 1 A613
 refined sodium azide liquor 1 A617
 second clear liquor 1 A616
 second mother liquor 1 A615
 sodium 1 A612–A613
 sodium azide, crystallization 1 A617
 sodium azide dilution tank 1 A617
 sodium azide feed tank 1 A617
 sodium azide, technical, prepared from
 hydrazine and ethyl nitrate 1 A617–A618
 wringer cake 1 A613
- SOFAR 9 S153
- Sofranex A (Fr) 9 S153
- Solenoid chronograph see Chronographs
3 C304–C319
- Solenite 7 I177
- Sulfite see Italian expls and related items 7 I177
- Solid-liquid adsorption chromatography
3 C290–C292
- Solid propnlts 8 P402–P473
- Solorhuen ammunition 9 S153–S155
- Solubility of expls 9 S154–S157
- Solventless powder see Cannon powder (propnlts)
2 C33; Propnlts solid 8 P405–P406, P420
- Solvent naphtha, nitrated 8 N4
- Solvent powder see Single-base and double-base
cannon propnlts 2 C31–C33; Production
methods of representative propnlts 8 P420
- Solvent removal by evaporation and drying see
Drying 5 D1560–D1565
- Soman (GD) see Methylpinacoloxylfluoro-
phosphine oxide 5 D1309
- Sonar 9 S157–S158
- Sonic booms' threat to expl facilities 9 S158
- Son nitre (Fr) see Bran 2 B260
- Sonite (Brit) 9 S158
- Sophonius incendiary composition 9 S158
- Sorbitol and derivs see D-Glucitol 6 G81–G82;
9 S158–S160
 sorbitol hexanitrate 9 S159–S160
 sorbitol nitrate 9 S158
 sorbitol pentanitrate 9 S159
- Soude, Dynamite a la (Fr) 9 S160
- Sound as a weapon 9 S160
- Sound or noise suppressors 9 S160–S162
 , background of 9 S160–S161
 , general requirements of 9 S161–S162
 sound suppressor experiments 9 S162
- Sound test for detonators 1 XXIV
- Sound velocity thru expls 9 S162–S163
- SP₁, SP₂, SP₃ (poudres) 9 S163
- SP₂SD 9 S163
- Spanish commercial expls see Spanish commercial
expls 3 C441–C442; Spanish permissible
expls 3 C454–C455
- Spanish Dynamites and their substitutes
9 S163–S164
- Spanish expls and ammunition 9 S164–S175
 , historical 9 S164
 , listing of, in alphabetical order 9 S164–S175
- Spanish infantry weapons in current service
9 S176–S177
- Spark sensitivity of expls see Electrostatic
discharges and sensitivity of expls to initiation
by them 5 E38–E55
- Sparrow (AIM-7F) 9 S177
- Sparte nitre (Fr) 9 S177
- Special area distances 9 S177
- “Special list” expls (Brit) 9 S177
- Specifications, table of US 6 E483–E488
- Specific force 2 B105–B106
- Specific gravity see Density and specific gravity
and their determination 3 D64–D85

- Specific heats of common expls 7 H45–H46
- Specific impulse 7 I63, L35; see also Liquid proplnts 7 L34–L44; Proplnts, solid 8 P402–P473
- Specific surface measurements see Particle size measurements 8 P52–P54
- Specific volume (measurement) see Volume of gases evolved on detonation 1 XXVI
- Spectroscopy of energetic materials 9 S178–S197
 , introduction to 9 S178
 , origin and interpretation of spectra 9 S179–S195
- Spence powders 9 S197
- Spent acid see Nitration 8 N45–N48
- Spezialsprenge latine (Swiss) 9 S197
- Sphere test 9 S197
- SPHF 9 S197
- Spigot mortar 9 S198
- Spinning detonation 9 S198
- Spiralit 9 S198
- Spirodihydantoin and derivs 9 S198–S199
 dinitrospirodihydantoin 9 S198–S199
- Spitback fuze 9 S199
- Spitback tube 9 S199
- SPIW flechette 9 S199–S202
- Spoiler actuator 5 D1111
- Sporting powders and ammunition see Bulk and condensed powders 2 B322–B323; Pyrodex 8 P500; 9 S202–S203
- Spot tests for expls and proplnts see Color reactions and color reagents 3 C405–C420
- Spotting charges 9 S203–S204
- Sprang gummi 9 S204
- Spray towers see Absorption towers 1 A7
- Spread of detonation see Detonation spread in expln 4 D402 ff
- Sprengel and Sprengel type expls 9 S204–S205
- Spring gages see Closed bomb 3 C337–C339
- “Springing” of boreholes 9 S205
- Spring 9 S205
- Squib 9 S205–S206
- Squid 9 S206
- SRAM (AGM-69A) 9 S207
- SSP 9 S207
- SS-waves see Damage potential of air and ground blast waves 3 D3–D4
- Stabilit see Acardite I 1 A7–A8
- Stabilite 9 S207
- Stabilite II 9 S207
- Stability of expls 4 D572
- Stability of expls and proplnts, determination of see Stability and instability of expls 6 E438; 9 S207
- Stability (thermal) of expls and proplnts see Heat tests 1 XV–XVI; 7 H59
- Stabilizers 9 S208
- Stab initiation see Instantaneous stab fuze detonators 4 D844–D846; Instantaneous stab fuze primers 4 D850–D852; Stab detonators 8 P381–P385
- Stacking and piling of ammunition see Piling and stacking of ammunition 8 P301
- “Stair-case” method see Impact, initiation of expln 7 I36–I37
- Standard muzzle velocity 9 S208
- Standardization of nitrometer to test ammonium nitrate 1 A375–A376
- Standoff 9 S208
- Stannic fluoride 6 F147
- Stannic oxide 8 O51
- Stannous fluoride 6 F147
- State properties of expls 4 D574
- Stanzprobe (Ger) see Punch test for expls 8 P496
- Starch see Amylopectin 1 A398, Amylose 1 A398–A399

- Starch dust explns see Dust explns
5 D1578–D1579
- Starch nitrated see Nitrostarch 8 N157–N162
- Starch powder 9 S209
- Startex A 9 S209
- Static electricity and sensitivity to initiation by
electrostatic discharge 9 S209
- Stearic acid and derivs 9 S209–S213
Al stearate 9 S210
ammonium stearate 9 S210–S211
Ba stearate 9 S211
Ca stearate 9 S211
ethyl stearate 6 E330
lead stearate 9 S211–S212
Mg stearate 9 S212
trinitroethyl stearate 6 F330
Zn stearate 9 S212–S213
- Steel (iron) plate tests for expls 1 XIX–XX;
Brisance or shattering effect 2 B265–B297
- Steelites 9 S213
- Steinau cartridge 9 S213
- Stellite 9 S213–S214
- Stemming 9 S214
- Stettbacher, Alfred 9 S214–S215
- Stilbazole perchlorates, the trinitro 9 S215
trinitrostilbazole perchlorates 9 S215
- Stilbene see Diphenylethylene and derivs
5 D1454–D1457; 9 S215–S216
- Stilbene oxide see α,α' -Diphenylethylene ether
and derivs 5 D1457–D1458
- Sting-soft rag 9 S216
- Stinger anti-aircraft guided missile system
9 S216–S217
- Stockholms superfosfat fabriks aktiebolag
9 S217
- Stokes law see Particle size measurements
8 P20–P21, P34, P38, P39, P43
- Stokes trench mortar 9 S217
- Stommonal 9 S217
- Stonite 9 S217
- Stonobel 9 S217
- Stooge rocket 9 S217
- Stoops expls 9 S217
- Stopin 9 S217
- Storite 9 S217
- Storm, Christian George 9 S217–S218
- Storvites 9 S218
- Stowmarket expln 9 S218
- Straight Dynamite 5 D1594, D1596–D1599
- Strain gages 3 C341–C342
- Strain waves in rocks 4 D576
- Strand burning rate determination 9 S218–S219
- Strawcellulose nitrate 9 S219
- Streak camera 2 C16
- Street expls see Cheddites 2 C155–C164
- Strength number test see Trauzl test
1 XXV–XXVI
- Strength of detonators, determination same as
Initiating efficiency of detonators tests
1 XVIII
- Strength of Dynamites 1 XXIV see Ballistic
mortar test 1 VII; Trauzl test 1 XXV–XXVI
- Strength of expls, test 1 XXIV see Trauzl test
1 XXV–XXVI; 9 S219–S220
- Strength number see Kraftzahl 7 K18
- Strike-anywhere match 8 M40
- Striker composition see Friction primers 8 P386
- Strontium 9 S220–S221
- Strontium acetylde 1 A82
- Strontium carbonate 2 C59; 9 S221
- Strontium chlorate 2 C200–C201; 9 S221
- Strontium chlorite 3 C246
- Strontium chromate 3 C282; 9 S221
- Strontium diazide 1 A620–A621; 9 S221
expl properties 1 A620
history of preparation 1 A620
other properties and uses 1 A620–A621

- Strontium diazide (cont'd)
 preparation 1 A620
 properties 1 A620
 thermal decomposition 1 A620
- Strontium fluoride 6 F147
- Strontium hydride 9 S221
- Strontium nitrate 8 N38–N39; 9 S221–S222
- Strontium oxalate 8 O32; 9 S222
- Strontium perchlorate 8 P618–P169; 9 S222
- Strontium peroxide 8 P192–P194; 9 S222
- Strontium picrate 8 P283
- Stubenrauch expls 9 S223
- Studentnyi (zhelatin) Dinamit or plasticheskii
 Dinamit see Russian nonpermissible expls
 3 C441
- Stump powder 9 S223
- Sturcke expl 9 S223
- Styphnate, bis-basic-diethyl lead 2 B141
- Styphnate, bis-triethyl lead 5 D1288
- Styphnic acid and derivs 5 D1276–D1288;
 9 S223–S224
- Styrene and derivs see Dinitropolystyrene
 8 N143–N144; 9 S224
 2,4,6-trinitro-styrene 9 S224
- Su and Chang (detonation) equation of state
 4 D293
- Subcaliber ammunition 9 S224
- Subcaliber gun 9 S224
- Submarine fuel, Winands 9 S224
- Subroc (UUM-44A) 9 S224–S225
- Substitute Dynamite 9 S225
- Substitute Dynamites, an additional reference
 listing, without compositions
 5 D1744–D1748
- Succinate, bis (2,2-dinitropropyl) 5 D1500;
 8 P492
- Succinic acid and derivs 9 S225–S227
 azido-iso-succinic acid 9 S225
 azidosuccinic acid diazide 9 S225
- Succinic acid and derivs (cont'd)
 bis-succinic acid trinitroethyl ester 9 S226
 dinitrososuccinyl dianilide 9 S226
 4,5-dinitro-succinylfluorescein 9 S226
 ibid diacetate 9 S226
 ethyldiazosuccinate 6 E225
 iso-succinic acid diazide 9 S225
 peroxy succinic acid 8 P214
 ibid polymer 8 P218
 succinic acid-bis-[3-nitryloxy-2,2-bis-
 nitryloxymethyl-propyl ester] 9 S226
 succinic acid-mono-[3-nitryloxy-2,2-bis-
 nitryloxymethylpropyl ester]
 9 S225–S226
 succinimide 9 S226
 succinylozoinide 9 S226
 2,4,5,7-tetranitrosuccinylfluorescein 9 S226
 ibid diacetate 9 S226–S227
- Succimonitrile see 1,2-Dicyanoethane 5 D1218
- Sugar alcohols and their nitrated derivs see
 Glucosides, nitration studies 6 G84; 9 S227
 dulcitol 5 D1567–D1568
 erythritol 5 E123–E125
 levoglucosan 6 G83
 D-mannitol 8 M13–M16
 L-rhammitol 9 S227
 D₂-sorbitol 9 S158–S160
 xylitol 9 S227
- Sugar and their nitrated derivs 9 S228–S233
 listing of nitrated sugar derivs 9 S228–S233
- Sugar dusts, expl properties of see Detonation
 and expln of dusts, mists and vapors
 4 D253–D255; Dust, explosibility of and dust
 explns 5 D1578–D1579
- Sulfanilic acid and derivs 9 S233–S234
 N-acetyl sulfanilic acid azide 9 S233
 3,5-dinitro-sulfanilic acid 9 S233–S234
 sulfanilic acid azide 9 S233
 sulfanilic acid hydrazide 9 S233
- Sulfates 9 S234–S235
 ammonium sulfate 9 S234
 barium sulfate 9 S234
 potassium sulfate 9 S234–S235
- Sulfides 9 S235–S238
 antimony sulfide 9 S235–S236
 arsenic sulfide 9 S237
 arsenic trisulfide 9 S237
 Ca sulfide 9 S237

Sulfides (cont'd)

- hydrogen sulfide 9 S237
- hydrogen trisulfide 9 S237–S238
- nitrogen sulfide 9 N102
- 2-propynyl vinyl sulfide 9 S238
- sulfobenzide, hexanitro see 2,4,6,2',4',6'-
Hexanitrodiphenylsulfone 5 D1480
- sulfocyanate, copper see Copper thiocyanates
3 C527–C528
- sulfocyanate lead see Lead thiocyanate
7 L11

Sulfonalkylchloramides and sulfondichloramides
7 H7

- Sulfone, bis (trinitropropyl) see 3,3,3,3',3',3'-
Hexanitropropyl-sulfone 5 D1510

- Sulfonic acid compounds 9 S238–S240
, listing 9 S238–S240

- Sulfonium radical compounds or sulfines 9 S240
trimethylsulfonium perchlorate 9 S240

- Sulfoxide radical and deriv listing 9 S240–S241

- Sulfur 9 S241–S247

- Sulfur dinitride, di 9 S247

- Sulfur hexafluoride 6 F148; 9 S247

- Sulfuric acid 9 S247–S250

- Sulfurite 9 S240

- Sulfur nitride 8 N102–N103

- Sulfur oxyfluoride 6 F148

- Sulfurous oxyfluoride 6 F148

- Sulfur-saltpeter 9 S250

- Sulfuryl diazide 1 A621

- Sunflower stalks 9 S250

- Sunlight, effect on expls see Light, effect on
expls 7 L14

- Super-ammodyne 9 S250

- Supercharge 9 S250

- Supercord 9 S250

- Super-excellite 4 9 S250

- Super gel A; gel B 9 S250–S251

- Super gun 9 S251–S252

- Super kolax 9 S252

- Super-nitrated liquids 9 S252

- Supernapalm 9 S252

- Superquick fuze 9 S252

- Superoxides see Peroxides 8 P184–P209

- Super-rippite 9 S253

- Suppressive shielding see Materials of
construction of ammunition plants
8 M42–M45

- Suppressor, flash see 6 F7 and Flash-reducing
agents 6 F96–F100; 9 S253

- Surveillance 9 S253

- Surveillance test, 78° 1 XXIV

- Surveillance tests, 65.5° and 80° 1 XXIV

- Susan sensitivity test 4 D334–D335;
9 S253–S255

- , on Comp B-3 9 S255

- , on Cyclotol 75/25 9 S254

- , on Octol 75/25 9 S255

- , on TNT 9 S254

- Swale powder 9 S255

- Swalite 9 S255

- Swatter 9 S256

- S- and SS-waves see Damage potential of air
and ground blast waves 3 D3–D4

- Sweating 9 S256

- Swedish expls 9 S256–S260
, listing of 9 S257–S260

- Swedish weapons in current service 9 S261

- “Sweetie” barrel 9 S261

- Swelling coefficient see Coefficient de
gonflement 3 C389

- “Swing” see Ballistic pendulum test
1 VII and VIII

- Swingfire 9 S261–S262

- Swiss expls 9 S262–S264
, listing of 9 S262–S264

- Swiss weapons in current (circa 1980) service
9 S264–S265

SX-2 9 S265

Sylvic acid 1 A2-A3

Symon Alde expls 9 S265

Sympathetic detonation tests 1 X; 4 D395–D402

air-gap test 4 D397–D398

booster-gap expl sensitivity test of Cole &
Edwards 4 D398

card-gap sensitivity test of Cook et al 4 D398

card test 4 D399

coefficient de self-excitation 3 C390

four cartridge test 4 D399

Sympathetic detonation tests (cont'd)

gap tests 1 XIV

halved-cartridge gap method 1 XIV

shock-pass-heat-filter 4 D399

three-legged table sensitivity test
4 D399

wax gap test 1 VIII

whole cartridge sensitivity test 4 D399

“Synoxyd” primary compositions 9 S112

Sy stability test 9 S265

Sytamit 9 S265

- T₁, T₂ and T₃ (Fr) 9 T1
- T₄ (Ital) 9 T1
- T₇ and T₁₂ proplnt (US) see M15 and M15 proplnt 2 C34 (table V)
- Table of distances, American see Safety in the energetic materials field 9 S13 (table 3)
- Tabun trilon 83, T83 or T100 see Dimethylaminocyanophosphoric acid, monomethyl-ester of 5 D1308–D1309
- TACOT 9 T1–T2 see Tetranitrodibenzo-1,3a,4,6a-tetrazapentalene 5 D1184–D1185
- Tagging of expls 9 T3–T27
 , cost of the 9 T21–T27
 , detection 9 T12–T20
 , effectiveness of 9 T20–T21
 , identification 9 T8–T12
 , introduction to 9 T3
 , profile of the bombing threat leading to 9 T4–T8
- TAGN (Triaminoguanidine nitrate) 9 T28–T29
 triaminoguanidine perchlorate 9 T28
 triaminoguanidine picrate 9 T28
- Taliani test 1 XXIV–XXV; 9 T29
- Talos 9 T30
- Tamping 9 T30
- Tanoyaku (Jap) 9 T30
- Tantalum 9 T30
- Tapered bore gun 9 T30–T31
- Tapered bore (folding skirt) projectiles 9 T31–T32
- Target charge 9 T32
- Tarnovski expls 9 T32
- Tars, nitrated 9 T32
- Tartaglia, Niccolo 9 T32
- Tartar (RIM-24) 9 T32–T33
- Tartaric acid and derivs 9 T33
 N,N-dinitro dimethyldiaminodinitrotartaric acid 9 T33
 d-tartaric acid diazide 9 T33
 Lg-tartaric acid dinitrate 9 T33
- TATB (1,3,5-Triamino-2,4,6-trinitrobenzene) 9 T34–T35
 analytical 9 T51–T52
 preparation 9 T34–T37
 properties 9 T37–T45
 uses 9 T45–T50
- TAX same as 1,5-Dinitro-3-acetyl-1,3,5-triazine 1 A50
- TBB 9 T55
- TDBP detonation wave 4 D582–D583
- TEA (triethylaluminum) 9 T55–T56
- TEB (triethylborane) 9 T56
- Tees powder 9 T56
- Teflon see Polytetrafluoroethylene 8 P351–P352; 9 T56
- TEFO 9 T56
- TEGDN (Triethyleneglycoldinitrate) 9 T56–T59
 , expl properties of 9 T57
 , preparation of 9 T57
 , toxicity of 9 T58–T59
 , uses of 9 T57–T58
- Teledet 9 T59–T60
- Telemetry 9 T60–T61
- Television guidance 9 T61–T62
- Tellurium 9 T62
- Tellurium nitride 8 N103
- Telsits see Swiss commercial expls of non-permissible type 3 C444; 9 T62
- Temperature developed on detonation (or expln) 1 XXV see Experimental determination of temperature of detonation 4 D592–D601; Detonation temperature and its determination D583–D589; Detonation temperature developed on 4 D589–D601
- TEN 9 T62
- TeNA same as Tetranitroanilines 1 A411–A412
- TeNAns same as Tetranitroanisoles 1 A454
- TENAzxb see Tetranitroazoxybenzene (USA) 1 A667–A668

- TeNB see Tetranitrobenzene 2 B50
- TeNBu see Tetranitrobutane (USA)
2 B367–B368
- TeNCB see Tetranitrochlorobenzene 3 C251
- TeNCbz see Tetranitrocarbazole (USA)
2 C48–C50
- TeNCRs see Tetranitrocresol 3 C558
- TeNDG see Tetranitrodiglycerine (USA)
5 D1261
- TeNDPhA see Tetranitrodiphenylamines
5 D1433–D1434
- TeNMA see Tetranitromethylaniline (USA)
8 M101
- TeNMe see Tetranitromethane (USA)
8 M83–M85
- TeNN see Tetranitronaphthalene (USA)
8 N14–N16
- TeNOx see Tetranitrooxanilide (USA) 8 O36
- Tensile strength of expls 9 T63, T64–T67
(tables 1 & 2)
- Terephthalic acid and derivs see Terephthalic
diperoxy acid 8 P214, Phthalic acid
P262–P265
- Terminal ballistics 9 T63, T67–T68
- Terminalia chebula 9 T69
- Terminal velocity 9 T68–T69
- Terne Mk 8 9 T69
- α -Terpineol ozonide 8 O72
- Terrier 9 T69
- Territ 9 T69
- Terrorite see Mindeleff expl 8 M131
- Tertiary-butylhydroperoxide see
Butylhydroperoxide 2 B385
- Tertiary-butyl peracetate see
Butyl peroxyacetate 2 B387
- Testing galleries see Coal mining expls, testing
for permissibility 3 C370–C378; 9 T70
- Testing of expls 9 T69–T70 (listing of entries)
- Testing of fuzes, physical 4 D1092
- Test of Ab der Halden 3 C389
- Test of Marquoyrol and Florentin 3 C389
- Test papers see Lead acetate 1 A28; Methyl
violet tests 8 M118–M120
- Tests for detonators and primers, miscellaneous
safety 4 D1088
- Tests, physical for determining expl and other
properties of items described in the Encycl
1 VII–XXVI
- Tests required for various US military specifica-
tions for detonators, primers, igniters and
delays, physical 4 D1088
- TETA (triethylenetetramine) see Bis(amino-
ethylamino)-ethane 2 B129; 9 T70
- Tetraacrylonitrile copper (II) perchlorate 9 T70
- Tetra-aquaethylenediaminocupric perchlorate see
Ethylenediamine complexes 6 E235
- 1,3,5,7-Tetraazabicyclo [3.3.1]-nonane,
3,7-dinitroso see Endomethylenetetraazo-
cyclooctane 5 E90–E91
- 2,3,7,8-Tetraazaspiro [4.4] non-2,7-diene
9 T70–T71
- 2,3,7,8-Tetraazaspiro [4.4] nonane 9 T70
- 2,3,5,6-Tetraazido-1,4-benzoquinone
2 B80; 9 T71
- 3,4,5,6-Tetraazido-1,2-benzoquinone 2 B80
- Tetraazido-4,4-diphenoquinone 5 D1414
- 2,4,6,8-Tetrabromo-1,5-dinitramino-
anthraquinone 9 T71
- 3,3',5,5'-Tetrabromo-4,4'-dinitramino
benzalazine 9 T71
- N,N,N',N'-Tetrabutylethylenediamine
diperchlorate 9 T71
- Tetracene see Guanyl nitrosaminoguanyl
tetrazene 6 G169–G172, Tetracene salts
G172
- N,N,N',N'-Tetrachloroadipamide 9 T71
- Tetrachloroiodoguanidine 6 G166
- Tetrachromates 3 C288

- Tetrachromates, listing 3 C288—C289
 ammonium tetrachromate 3 C288—C289
 potassium tetrachromate 3 C289
 sodium tetrachromate 3 C289
- Tetraethanol ammonium pentanitrate 9 T71
- Tetraethylammonium nitrate 9 T72
- Tetraethylenepentamine perchlorate (TEPAP)
 9 T72
- N,N,N',N'-Tetraethylethylenediamine
 diperchlorate 9 T72
- Tetraethylozonide see Ethylozonide 8 O70
- Tetraethynylgermanium 9 T72
- Tetrafluorohydrazine 6 F148; 9 T72
- Tetrafluoromethane see Carbon tetrafluoride
 2 C64
- Tetrahydrofuran (THF) and derivs see
 Butylene oxides 2 B382; 9 T72—T73
 3,4-dinitroxy tetrahydrofuran see
 Erythranediol dinitrate 5 E123
- 1,4,5,6-Tetrahydro-6-oxopyridazine carbonyl
 azide 9 T73
- 1,1,4,4-Tetrahydroperoxycyclohexane tetra-
 acetate 9 T73
- Tetrahydropyrimidine, 2-nitrimino-5-nitroxy
 9 T73
- Tetrahydroxybiphenyl, hexanitro see
 Hexanitrobiresorcinol 2 B127
- Tetrahydroxy biphenyl, tetranitro see
 Tetranitrobiresorcinol 2 B127
- 1,2,3,4-Tetraiodofuran 6 F240
- Tetrakis (nitraminomethyl) methane see
 Pentaerythrityltetrakis (nitramine)
 8 P126—P127
- Tetralina (Span) see Tetranitroaniline
 1 A411—A413
- Tetralin hydroperoxide see 1,2,3,4-Tetrahydro-1-
 naphthyl hydroperoxide 8 P207; 9 T73
- Tetralin, 5-nitro 9 T73—T74
- Tetralin, 6-nitro 9 T74
- Tetralita no 1 see 2,3,4,6- (or 2,4,5,6) Tetranitro-
 N,N-dimethylaniline 5 D1316
- Tetralita no 2 see Pentanitro-N,N-dimethyl-
 aniline 5 D1316
- Tetralite (Ital) see Tetryl 7 I179; 9 T148—T164
- Tetramethoxydiphenyl, hexanitro 9 T74
- Tetramethylammonium azidodithiocarbonate
 1 A637
- Tetramethylammonium chlorate 2 C201; 9 T74
- Tetramethylammonium chlorite 3 C246; 9 T74
- Tetramethylammonium hydrotriborate
 9 T74—T75
- Tetramethylammonium nitrate and derivs
 9 T75—T78
 tetramethylammonium dinitrate (TeMeADN)
 9 T77—T78
 tetramethylammonium perchlorate 9 T78
 tetramethylammonium permanganate 9 T78
- Tetramethylazobenzene see Azoxylene 1 A662
- Tetramethylazoxybenzene see Azoxyxylene
 1 A673
- N,N,N',N'-Tetramethyl-1,3-butanediamine
 diperchlorate 9 T78
- N,N,N',N'-Tetramethyl-2-butene-1,4-diamine
 diperchlorate 6 T78
- 1,1,4,4-Tetramethyl-2-butynylenedihydro-
 peroxide see Acetylene dihydroperoxides
 1 A66
- N,N,N',N'-Tetramethyldecanediamine
 diperchlorate 9 T79
- Tetramethyldiaminobenzene see Diaminotetra-
 methylbenzene and derivs 5 D1144
- Tetramethylenediamine diperchlorate 9 T79
- Tetramethylene-diperoxidedicarbamide 9 T79
- N,N,N',N'-Tetramethylethylenediamine
 diperchlorate 9 T79
- 1,1,2,2-Tetramethylethylhydroperoxide-p-
 nitrobenzoate 9 T79
- N,N,N',N'-Tetramethyl-1,6-hexanediamine
 diperchlorate 9 T79
- Tetramethyl lead (TML) 9 T79—T80
- N,N,N',N'-Tetramethylneopentanediamine
 diperchlorate 9 T80

- Tetramethylcyclohexanone tetranitrate **9 T80**
- Tetramethylcyclopentanol pentanitate see Fivolite **6 F40–F41; 9 T80**
- Tetramethylcyclopentanone tetranitrate see Fivonite **6 F41; 9 T80**
- 1,1,4,4-Tetramethylol-1,4-dinitrobutane tetranitrate **9 T80**
- 1,1,5,5-Tetramethylol-1,5-dinitropentane tetranitrate **9 T80**
- N,N,N',N'-Tetramethyl-1,3-propanediamine diperchlorate **9 T81**
- 2,2,23,23-Tetramethyl-tetracos-7 ξ ,9 ξ ,15 ξ ,17 ξ -tetraene-3,5,11,13,19,21-hexayne **8 P326**
- 1,1,4,4-Tetramethyltetramethylenedihydroperoxide see 2,5-Bis (hydroperoxy-2,5-dimethyl)-hexane **2 B144**
- Tetramino cupric nitrate **9 T81**
- Tetramminopermanganate, Cd **9 T70**
- 2,4,6,8-Tetranitramino-1,3,5,7,9-pentamethylene-1,9-dinitrate **9 T81**
- 2,4,6,8-Tetranitranitramine-1,9-dimethoxy-1,3,5,7-pentamethylene **5 D1304**
- Tetranitroacetamidodiphenylether **1 A18**
- 2,3,4,6-Tetranitroacetanilide **1 A24, A87**
- Tetranitroacetoxo diphenylamine **1 A51**
- 2,4,5,7-Tetranitro-1-acetoxynaphthalene **1 A52**
- Tetranitroacetyldiphenylamine **1 A58**
- 2,4,5,7-Tetranitro-9 (10H)-acridone **1 A96**
- Tetranitroaloeemodine **1 A140**
- Tetranitroaminodiphenylamines **1 A198**
- X-Tetranitro-3-aminodiphenyleneoxide **1 A198**
- 3,5,2',4'-Tetranitro-4-aminodiphenylether **1 A199**
- 2,4,5,7-Tetranitro-8-amino-1-hydroxy-anthraquinone **1 A217**
- Tetranitroaminomethylbiphenyls **1 A229**
- Tetranitroaminonaphthalenes **1 A237–A238**
- Tetranitroaniline see 2,3,4,6-Tetranitroaniline (TeNA) **1 A411–A414; 9 T81**
- Tetranitroaniline expls **1 A414**
- Tetranitroanilines (TeNA) **1 A411–A412**
- 2-(N,2',4',6'-Tetranitroanilino)-1-butanol nitrate **1 A423**
- Tetranitroanilinotoluenes; tetranitrodiphenylmethylamines **1 A439–A440**
- Tetranitroanisoles (TeNAns) **1 A454**
- Tetranitroapigenins **1 A474**
- Tetranitroaurine **1 A509**
- Tetranitrobenzaldehydeazines **2 B36**
- Tetranitrobenzene **2 B50**
- Tetranitrobenzil **2 B64–B65**
- 5,6,7,8-Tetranitrobenzo-1,4-dioxan **2 B67**
- Tetranitrobenzophenone **2 B78**
- X,X,X,X-Tetranitro-2,3-benzophenoxazine **2 B78**
- Tetranitrobenzophenyltriazole **2 B79**
- Tetranitrobenzotoluide **2 B86**
- 2,6,2',6'-Tetranitrobenzylamine **5 D1189**
- Tetranitrobenzylaniline **2 B93–B94**
- Tetranitrobenzylideneaniline **2 B98**
- Tetranitrobenzyltoluidine **2 B101**
- Tetranitrobibenzyl **2 B110**
- Tetranitrobicresol **2 B112–B113**
- 1,5,1',5'-Tetranitro-2,2'-biimidazole **2 B115**
- Tetranitrobiphenol **2 B122**
- Tetranitrobiphenyldicarboxylic acid **2 B126**
- Tetranitrobiphenyl isomers **2 B124; 9 T82**
- Tetranitrobiresorcinol **2 B127**
- 3,5,3',5'-Tetranitro-2,2'-bithiophene **2 B163**
- Tetranitro-bitolyl **2 B163**
- Tetranitrobromomethylaniline **2 B314**
- Tetranitrobromophenol **2 B315**
- 2,2,3,3-Tetranitrobutane **2 B367–B368**
- 1,1,4,4-Tetranitro-2,3-butanediol **2 B370**
- Tetranitrobutylaniline **2 B379**

- 2,4,5,6-Tetranitro-3-(tert-butyl)-toluene 2 B389
 Tetranitrocarbanilide 2 C44
 Tetranitrocarbazole (TNC) 9 T82
 "Tetranitrocellulose" 9 T82-T83
 Tetranitrochlorobenzene 3 C251
 Tetranitrochloromethylaniline 3 C261
 2,3,4,6-Tetranitro-5-chlorophenol 3 C263
 Tetranitrochrysene 3 C320
 Tetranitrochrysenedione 3 C321
 Tetranitrocresols 3 C558
 β,β,β -Tetranitrocumene 3 C574
 x-Tetranitrodiacetylaminophenol 5 D1120
 Tetranitrodiaminoanthraquinones 5 D1128
 Tetranitrodiaminobenzene 5 D1131
 3,3',5,5'-Tetranitro-4,4'-diaminobenzil 5 D1131
 3,5,3',5'-Tetranitro-4,4'-diaminobenzophenone
 5 D1132-D1133
 4,6,4',6'-Tetranitro-3,3'-diaminobiphenyl
 5 D1133
 Tetranitrodianisoles 5 D1152
 Tetranitrodibenzofurans 5 D1183-D1184
 Tetranitrodibenzo-1,3a,4,6a-tetrazapentalene see
 TACOT 5 D1184-D1185
 3,5,3',5'-Tetranitrodibenzoyl peroxide 5 D1188
 X,X,X,X-Tetranitrodibenzylmethane 5 D1190
 Tetranitrodichloroazobenzenes 5 D1205
 3,5,3',5'-Tetranitro-4,4'-dichloroazoxybenzene
 5 D1206
 3,5,3',5'-Tetranitro-N,N'-diethylbenzidine
 5 D1228-D1229
 Tetranitrodiglycerin (TeNDG) see Diglycerol
 and derivs 5 D1261
 2,4,6,8- (or X,X,X,X-) Tetranitro-1,5- (or 2,7-)
 dihydroxynaphthalene 5 D1294-D1295
 1,5,1',5'-Tetranitro-diimidazolyl-(2,2') and its
 salts 9 T83
 3,5,3',5'-Tetranitro-N,N'-diisobutylbenzidine
 5 D1196
 3,5,3',5'-Tetranitro-N,N'-diisopropylbenzidine
 5 D1496
 2,4,6,8-Tetranitro-1,5-dimethoxynaphthalene
 5 D1304
 2,6,2',4'-Tetranitro-N,N'-dimethyl-p-aminobi-
 phenyl 5 D1308
 2,3,4,6- (or 2,4,5,6-) Tetranitro-N,N'-dimethyl-
 aniline (tetralita no 1) 5 D1316
 Trinitro-N,N'-dimethylanilines 5 D1315
 $\alpha,\alpha,\alpha',\alpha'$ -Tetranitro-1,3-dimethylbenzene
 5 D1325
 3,5,3',5'-Tetranitro-N,N'-dimethylbenzidine
 5 D1326
 3,5,3',5'-Tetranitro-2,4-dimethylbenzophenone
 5 D1327-D1328
 4,6,4',6'-Tetranitro-N,N'-dimethyl-3,3'-di
 (methylamino)-diphenyl 5 D1337
 Tetranitrodimethyldiphenylether 5 D1337
 X,X,X,X-Tetranitro- β,β' -dinaphthylamine
 5 D1379
 2,4,6,8-Tetranitro-5-dinitraminoanthraquinone
 5 D1128
 2,2,8,8-Tetranitro-4,6-dioxa-1,9-nonanediol
 5 D1405
 Tetranitrodiphenylamines (TeNDPhA)
 5 D1433-D1434
 2,4,6,8-Tetranitrodiphenylaminesulfone
 5 D1440-D1441
 2,4,5,7-Tetranitrodiphenylaminesulfoxide
 5 D1441
 Tetranitrodiphenylamino-N-ethanol 5 D1442
 X,X,X,X-Tetranitro-1,2-diphenylcyclopentane
 5 D1448
 2,4,2',4'-Tetranitrodiphenyldianthranilide
 5 D1448
 Tetranitrodiphenyldisulfides 5 D1450
 X,X,X,X-Tetranitro-o-diphenylene 5 D1451
 Tetranitrodiphenylphenylenediamines 5 D1471

- Tetranitrodiphenylethers 5 D1452–D1453
 Tetranitrodiphenylethylene 5 D1455–D1456
 Tetranitro-*N,N'*-diphenylhydrazine 5 D1462
 2,4,2',4'-Tetranitro-diphenyl methane 5 D1466
N,N'-Tetranitrodiphenylpiperazine 5 D1475
 2,4,2',4'-Tetranitrodiphenylselenide 5 D1476
 2,4,2',4'-Tetranitrodiphenylsulfide 5 D1477
 2,4,2',4'-Tetranitrodiphenylsulfone 5 D1479
 Tetranitro-2,4-diphenyl-2,1,3-triazole
 5 D1486–D1487
 2,4,2',4'-Tetranitrodiphenylurethane 5 D1488
 2,2,2',2'-Tetranitro-dipropylamine 5 D1493
 3,5,3',5'-Tetranitro-*N,N'*-dipropylbenzidine
 5 D1495
 2,2,2',2'-Tetranitrodipropyl succinate 5 D1500
 3,5,3',5'-Tetranitro (di- α -pyridylamine) 5 D1503
 4,6,4',6'-Tetranitro-3,3'-ditolyl-disulfide
 5 D1516
 4,6,4',6'-Tetranitro-di-(*m*-tolyl)-hydrazine
 5 D1517
 X,X,X,X-Tetranitro-2,2-di-*p*-tolylpropionic acid
 5 D1518
 Tetranitro-ditolyl-sulfides 5 D1518
 Tetranitroerythritol 5 E124–E125
 Tetranitroethyltoluidine 6 E335
N,2,4,6-Tetranitro-5-(*N*-ethyl)-*m*-xylidine 6 E341
 Tetranitrofluoranthene 6 F120
 Tetranitrofluorenones 6 F123
 Tetranitrogen tetrasulfide see Sulfur nitride
 8 N102–N103
 Tetranitroglycoluril 6 G117–G118; 9 T83
 Tetranitrohexanediols 7 H88
 Tetranitrohexanes 7 H87–H88
 Tetranitrohydroxybenzophenyltriazole 2 B79
 Tetranitromethane (TeNMe) 8 M83–M85
 Tetranitromethylaniline 9 T83
 Tetranitro-2-methyl naphthalene 8 M109
 Tetranitronaphthalene (TeNM) 8 N14–N16
 Tetranitro-1-naphthols 8 N20
 2,3,4,6-Tetranitro-*N*-nitroacetanilide 1 A24
 Tetranitronitraminomethyldiphenylamines
 1 A230
 1,3,5,7-Tetranitro, octohydro-1,3,5,7-tetrazocine
 (HMX) see Cyclotetramethylenetetranitra-
 mine 3 C605–C610; 8 P415–P416;
 9 T83–T99 (additional refs, circa 1980 from
 Expls to Pyrotechnics)
 2,4,2',4'-Tetranitrooxanilide (TND) 8 O36–O37
 2,3,5,6-Tetranitrophenetole 8 P228
 Tetranitrophenols 8 P233
 1,3,5,7-tetranitrophenothiazine 8 P235
 2,3,4,6-Tetranitrophenylmethylnitramine
 9 T99–T100
 2,3,4,6-Tetranitrophenylnitramine 8 P243
 2,4,5,7-Tetranitrosuccinylfluorescein and its
 diacetate 9 S226–S227
 Tetranitrosulfoxydiphenylamine see
 Tetranitrodiphenylaminesulfoxide 5 D1441
 2,4,6,8-Tetranitro-1,3,5,7-tetrahydroxyanthra-
 quinone 1 A458–A459
 X,X,X,X-Tetranitro-3,4,3',4'-(tetramethyl-bi-
 phenyl) 2 B165
 3,5,3',5'-Tetranitro-4,4'-tetramethyldiamino-
 biphenyl (TNTMB) 9 T100
 1,3,5,7-Tetranitro-1,3,5,7-tetrazacyclooctane
 (HMX) 3 C605–C610; 9 T83–T99
 2,4,5,7-Tetranitro-1,3,8-trihydroxy-6-methyl-
 anthraquinone 5 E87
 Tetra (2-nitroxyethyl) ammonium nitrate 9 T100
 Tetranitroxy-3,3,5,5-tetrakis (nitroxymethyl)-
 4-oxypyrene 1 A404
 Tetraoxymethylene 6 F165
 Tetraoxymethylene diperoxide see
 Cyclodioxymethylene peroxide 3 C594
 Tetrapentaerythritol and its decanitate deriv
 9 T100

- 1,4,7,10-Tetrapicrylhexamethylene-1,4,7,10-tetramine, 1,10-dinitro **9 T101**
- Tetra (2,4,6-trinitrophenyl)nitraminomethyl methane **9 T101**
- Tetravinyl lead **9 T101**
- 1,3,5,7-Tetrazabicyclo [3.3.1]-nonane, 3,7-dinitro see DPT **5 E91–E93**
- 1,4,7,10-Tetrazadecanes, nitrated **2 B129–B130**
- Tetrazenes **9 T101–T109**
 , listing of **9 T103–T109**
- Tetrazidocuprate metal salts see Cupric azide complexes **1 A533–A534**
 Ba tetrazidocuprate **9 T109**
 Sr tetrazidocuprate **9 T109**
- Tetrazines and derivs **9 T109–T110**
 3,6-diamino-3,6-dihydro-sym-tetrazine dinitrate **5 D1135**
 3,6-diamino-sym-tetrazine hydrobromide **5 D1135**
 3,6-difluorenylidene-3,6-dihydro-sym-tetrazine **2 B143**
 3,6-dihydro-sym-tetrazine-3,6-di-carboxylic acid **5 D1267**
 di (tetrazolyl-5): 3,6-(dihydro-sym-tetrazine) **2 B157–B158**
 di (tetrazolyl-5): 3,6-sym-tetrazine **2 B158**
 octahydro-1-acetyl-3,5,7-trinitro-sym-tetrazine **1 A49–A50**
- Tetrazoles **9 T111–T141**
 1-amino-tetrazole **9 T115–T124**
 azido tetrazoles **9 T124–T125**
 azotetrazoles **9 T126–T129**
 methyl tetrazoles **9 T129–T133**
 5-nitrotetrazoles **9 T133–T139**
 phenyl tetrazoles **9 T139–T141**
 tolyl tetrazoles **9 T141**
- Tetrazolines **9 T142**
 (2-carboxamide, 5-nitroso)- Δ^4 -tetrazoline **9 T142**
- Tetrazolon-(5)-anil same as 5-Acetamido-1H-tetrazole **1 A21**
- α -Tetrazol-5-yl-guanidine **6 G166**
- α -Tetrazol-5-yl-guanidine nitrate **6 G166**
- Tetrazotic acid and derivs **9 T142–T147**
 derivs of tetrazotic acids **9 T142–T147**
- Tetrazylazide and its salts **9 T147**
 ammonium tetrazylazide **9 T147**
 barium tetrazylazide **9 T147**
 lead tetrazylazide **9 T147**
 organic tetrazylazides **9 T147**
 silver tetrazylazide **9 T147**
 sodium tetrazylazide **9 T147**
- Tetrazylazoimide and salts see Azotetrazole **1 A659–A660**
- Tetrethyl or Ethyl Tetryl **6 E207**
- Tetril **9 T148**
- Tetritol-Cyclonite **9 T148**
- Tetritols see Erythritol . . . erythritol tetranitrate **5 E123–E125**; Sugar alcohols and their nitrated derivs **S227, T148**
- Tetroxyl **9 T148**
- Tetryl **9 T148–T164**
 , analytical and military specifications **9 T152–T153**
 , deflagration to detonation transition and deflagration of **9 T161–T163**
 , detonation characteristics of **9 T155–T158**
 , history and uses of **9 T148**
 , initiation behavior of **9 T158–T161**
 , physical properties of **9 T148–T150**
 , preparation, chemical properties and toxicity **9 T150–T152**
 , thermal decomposition of **9 T153–T155**
- Tetrytols **9 T165–T166**
 , analytical and solubility of **9 T165–T166**
 , compatibility and exudation of **9 T165**
 , performance of **9 T166**
 , preparation of **9 T165**
 , sensitivity of **9 T166**
- Teutonite see Augendre powder **1 A507**
- TEX see 1,5-Diacetoxy-1,3,5-trimethylene-2,4-dinitramine **5 D118**
- Texas City disaster see Ammonium nitrate explns, fires and hazards **1 A359–A362**
- TFENA **9 T166**
- TFEt Tetryl **9 T167**
- TGSM **9 T167**
- Thallium, its salts and organic derivs **9 T167–T170**
 Tl azide **1 A621–A263**; **9 T168**

- Thallium, its salts and organic derivs (cont'd)
- Tl chloride, bis (chloromethyl) 2 B139
 - Tl diethyl chromate 9 T168
 - Tl diethyl-4:6-dinitro-2-amino phenoxide 9 T168
 - Tl diethyl-4-nitro-m-tolyl-oxide 9 T168
 - Tl diethyl picramate 1 A243
 - Tl dimethyl-p-nitrophenoxide 9 T168
 - Tl dimethyl picramate 1 A243
 - Tl-2,5-dinitrophenol 9 T169
 - Tl fulminate 6 F225-F226
 - Tl hexanitrodiphenylamine 9 T169
 - Tl MEDNA 8 M54
 - Tl nitride 8 N103
 - Tl picrate 9 T169-T170
 - thallous azidodithiocarbonate 1 A637
 - thallous chlorate 2 C201
 - thallous chlorite 3 C246
 - thallous-thallic azide 1 A623
- Thawing of Dynamite 5 D1588, D1596
- Theodorovic 9 T170
- Theories of expl (or detonative) reaction 9 T170
(listing of entries)
- Theory of burning of proplnts 2 B348
- The polyester polymer 4,4-dinitropimelyl chloride and 2,2-dinitro-1,3-propanediol 8 P302
- Thermal analysis, application of 5 D1255-D1256
- Thermal conductivity of expls 3 C498; see Heat conductivity coefficients and specific heats of common expls 7 H45-H46 (table 4)
- Thermal effects of impact see Impact initiation of expln by 7 I35 ff
- Thermal expansion, coefficient of 6 E350; 9 T170-T172
- Thermal expln 9 T173-T188
 - , applications of 9 T185-T188
 - , general characteristics of 9 T173-T175
 - , quantitative treatment of 9 T175-T185
- Thermal ignition see Ignition 7 I11-I30
- Thermal initiation see Initiation 7 I106-I109
- Thermal stability see Heat tests 1 XV-XVI; 7 H59
- Thermate and Thermite 9 T189
- Thermochemistry 9 T190-T204
 - , analytical tools of 9 T196-T201
 - , calculation of the adiabatic reaction temperature 9 T191-T193
 - , heats of reaction 9 T190-T191
 - , introduction to 9 T190
 - , sources of data used in 9 T202-T203
 - , the use of, in hazard assessment 9 T201-T202
 - , units of 9 T190
 - , use of thermodynamic tables in 9 T193-T196
- Thermodynamics 9 T205-T217
 - application of thermodynamics to detonation phenomena 9 T212-T216
 - the Chapman-Jouguet condition- 9 T209-T211
 - the laws of thermodynamics and thermodynamic identities 9 T205-T207
 - thermodynamic equations of state 9 T211-T212
 - thermodynamics, chemical equilibrium in 9 T208-T209
 - thermodynamics, general considerations and definitions 9 T205
 - thermodynamics, shock equations and 9 T209
 - use of the polytropic EOS 9 T215-T216
- Thermohydrodynamic theory of detonation see Hydrodynamic theories of detonation 4 D610-D619
- Thermometers, calibration of TNT 2 C6-C8
- Thianthrenium perchlorate 9 T218
- Thiazole and derivs 9 T218
 - 4-methyl-2-nitramino-3,5-dinitrothiazole 9 T218
 - 2-nitramino-5-nitrothiazole 9 T218
 - 2-thiazolinimine, 3,4-dinitro 9 T218
- Thickeners see M1, M2, M4 thickeners 8 M1; Napalm (thickened fuel) 8 N2-N3
- Thiocyanate, lead 7 L11
- Thiocyanic acid complexes of cobalt perchlorate 9 T218-T219
 - dithiocyanatocobalt (III) tetra-amine perchlorate 9 T218-T219
 - thiocyanatocobalt (III) pentammine diperchlorate 9 T218

- 4-Thiocyanophenylnitramine, 3,6-dinitro 9 T219
- Thiodiazole, X-dinitramino 9 T219
- Thional see 2,4,2',4',6'-Pentanitrodiphenyl-sulfone 5 D1480
- Thiophene and nitrated derivs 9 T219–T220
 2,5-dibromo-3,4-dinitrothiophene 9 T219
 dinitro-thiophenes 9 T219–T220
 3-methyl-2,4-dinitrothiophene 9 T220
- Thiophenol and derivs see Benzene-sulfenic acid 2 B60–B61; 9 T220
 2,4,6-trinitro thiophenol 9 T220
- Thiopicric acid 9 T220
- Thiosugars 9 T220, T221 (tables 1, 2 and 3)
- 1,2,3,4-Thiotriazole, 5-amino- 9 T220
- Thiotriithiazyl 9 T220, T222
 bromide 9 T220, T222
 chloride 9 T222
 iodide 9 T222
 nitrate 9 T222
- Thiourea nitrate 9 T222
- Thiourea perchlorate 9 T222
- 1-Thioureido-3-nitroguanidine 9 T222
- Thomas' expls 9 T222
- Thomas fume test (Dutch test) see Dutch stability test 5 D1580; Fume tests 6 F236–F238
- Thorite 9 T223
- Thorium and compounds 9 T223–T224
- Thorium dicarbide 1 A82
- Thorium tetrafluoride 6 F148
- Thorn, L. 9 T224
- Thread velocimeter see Benton's electro-ballistic pendulum 2 B34
- Three-legged table sensitivity test 4 D399
- Threitol tetranitrate see Erythritol tetranitrate 5 E124–E125
- Through-bulkhead initiator 9 T224–T225
- Throw-weight 9 T225
- Thruster see Cartridge-activated devices (CAD's) 2 C70–C72
- Thunderbird Mk 2 9 T225
- Thunder powder 9 T225
- Thunderites 9 T225
- Tigercat 9 T226
- Tiger computer program see Computers and computer programs 4 D180–D186
- Time of ignition (or expln) test 1 XVII see Expln-time test of double base proplnts 6 E389
- Time on target 9 T226
- "Timing systems and components" 9 T226–T227
- Tin 9 T227
- Tin azide 1 A624
- Tin nitrate 8 N39
- Tin oxide see Stannic oxide 8 O51
- Tipo C Amonal 9 T227
- Titan Dynamite 9 T227
- Titanium 9 T227–T229
- Titanium carbide 1 A82
- Titanium dioxide 8 O51
- Titanium hydride 9 T229–T230
- Titanium perchlorates 8 P169
- Titanium tetrachloride 9 T230–T231
- Titanium tetrafluoride 6 F148
- Titanium trifluoride 6 F148–F149
- Titan II missile (LGM-25C) 9 T231
- Titanites 9 T231
- TLP (Ger) 9 T231
- TM-1 (nitroammelide, USA) 1 A273
- TM-2 (cyanuric acid, USA) 3 C589
- TMA (ATM or trimethyl Al) 9 T231–T232
- TMA (Trimethylamine) 9 T232–T233
 nitrate (TMAN) 9 T233
 trimethylammoniumpentazidocuprate 9 T233

- TNA (1,3,5,7-Tetranitroadamantane) 9 T233
- TNA same as Trinitroanilines 1 A409–A411
- TNAME same as Aminonitroform 1 A239
- TNAmpH (trinitroaminophenol, USA) 1 A244
- TNAnd (trinitroanilide, USA) 1 A405
- TNAns same as Trinitroanisoles 1 A450–A453
- TNAPh same as 2,4,6-Trinitro-3-aminophenol
1 A244
- TNB see Trinitrobenzene 2 B47–B50;
9 T375–T378
- TNBA (trinitrobenzaldehyde, USA) 2 B35
- TNBAC see Trinitrobenzoic acid 2 B73–B75
- TNBxN (trinitrobenzoyl nitrate, Ger) 2 N90
- TNBzIN see 2,4,6-Trinitrobenzyl nitrate 2 B92
- TNC (tetranitrocarbazole, USA) 2 C48; 9 T82
- TNCB (trinitrochlorobenzene, USA) 9 T234
- TNCrs (trinitrocresol, USA) 3 C557
- TNDCB 9 T234
- TNDFB (or DFTNB) see 2,4,6-Trinitro-1,3-difluorobenzene 5 D1259
- TNDMA (trinitrodimethylaniline, USA) 5 D1317
- TNEB (trinitroethylbenzene, USA)
6 E212–E213
- TNEDNP see 2,2,2-Trinitroethyl-4,4-dinitropentanoate 6 E316
- TNEDV (trinitroethyl dinitrovalerate, USA)
6 E339
- TNEP see 1,1,1-Trinitro-2-ethoxypentane 6 E193
- TNEtB see 1-Ethyl-2,4,6-trinitrobenzene
6 E212–E213
- TNEtTNBu or TNETNB see 2,2,2-Trinitroethyl-4,4,4-trinitrobutyrate 6 E217
- TNFB see Fluoro-2,4,6-trinitrobenzene 6 F137
- TNG (trinitroglycerin, USA) 9 T383–T388
- TNM (tetranitromethane, USA) 8 M83
- TNMA (trinitromethylaniline, USA)
8 M100–M101
- TNMeL (trinitromelamine, USA) 8 M56
- TNMes (trinitromesitylene, USA) 8 M62
- TNN (trinitronaphthalene, USA) 8 N12–N14
- TNPE (Tetranitrato de Pentaeritrita; PETN, Span) 8 P86 ff
- TNO (tetranitrooxanilide, USA) 8 O36
- TNPh (Trinitrophenol; Picric Acid, USA)
8 P285 ff
- TNPhBuNA (trinitrophenylbutylnitramine, USA)
9 T234
- TNPhDA (trinitrophenylenediamine, USA)
8 P240
- TNPhENA (trinitrophenylethyl nitramine, USA)
9 T234
- TNPhl GI (trinitrophenylglucitol, USA) 8 P248
- TNPhMNA (trinitrophenylmethyl nitramine, USA) 9 T234
- TNPhMNAPh (trinitrophenylmethyl nitraminophenol, USA) 9 T234
- TNPhT (trinitrophenetole, USA) 8 P227
- TNR (trinitroresorcinol; styphnic acid, USA)
5 D1276
- TNRS (trinitroresortsinat svintsa; lead styphnate, Rus) 5 D1277 ff
- TNSTl (trinitrostilbene, USA) 5 D1455
- TNT (2,4,6-Trinitrotoluene) 9 T235–T298
, analytical techniques for 9 T287–T298
, chemical reactions and derivs of
9 T247–T259
, composite expls of 9 T280–T284
, disposal of waste 9 T277–T280
, expl properties of 9 T266–T277
, introduction to and chronology of 9 T235
, physical and thermochemical properties of
9 T259–T266
, preparation of 9 T235–T243
, purification of 9 T243–T297
, safety and toxicity of 9 T280
, unsymmetrical isomers of 9 T284–T287
- TNTAB see 1,3,5-Triazido-2,4,6-trinitrobenzene
2 B43–B44; 9 T352
- TNTMNA (trinitrotolylmethyl nitramine, USA)
9 T299

- TNX see Trinitroxylylene, commercial
5 D1324—D1325
- TOFLOX see Liquid propnlts 7 L34 ff; 9 T299
- Tolamex 9 T299
- Tolamite 9 T299
- Tolite or Trotyl (Fr) see French military expls,
requirements 6 F195; 9 T299
- Tol or Trotil (Rus) see Russian expls 9 R198
- Toluene and derivs 9 T300—T318
fluorotoluene and derivs 9 T318
picryl hydroxylamine toluene see
2,4,6-Trinitro-3-hydroxylaminotoluene
7 H297
the dinitrotoluenes 9 T305—T316
the mononitrotoluenes 9 T303—T304
the tetranitrotoluenes 9 T316—T318
the unsymmetrical trinitrotoluenes
9 T316—T317
"TNT" 9 T235—T298
toluene azides 9 T301—T303
toluene sulfoxide perchlorate 9 T318
- Toluene ozonide 8 O72
- p-Toluenesulfonylbutanoneoxime 2 P375
- Toluic acid derivs 9 T319
3,5-dinitro-2-bromo-p-toluic acid azide
9 T319
trinitro-p-toluic acids 9 T319
- o-Toluidine chlorate 2 C201; 9 T319—T320
- p-Toluidine chlorate 2 C201; 9 T320
- Toluidine perchlorates 9 T320
- Toluidine picrate 8 P284
- Toluidines, dimethyl and derivs 5 D1375—D1376
- Toluidines, o-, m- and p-dinitro 9 T320—T322
- Toluidines, see Amino toluenes and derivs
1 A264—A265
- o-, m- and p-Toluidino-diazido-Cu complexes
9 T319
- Toluol-ammonal 1 A291; 9 T322
- 4-o-Tolylazo-1-naphthylamine dinitrate 9 T322
- o-, m- and p-Tolyl Cu 9 T322
- Tomahawk (BGM-109) cruise missile
9 T322—T323
- Tonita see Spanish commercial expls of non-
permissible type 3 C442; Spanish expls and
ammunition 9 S164—S175
- Tonite 9 T323
- Tonka 9 T323
- "Toothpaste" expls 9 T323—T324
- Torpedo 9 T324, T325—T327 (tabulation of
torpedoes)
- Torpedo friction test see Friction sensitivity
tests (quantitative) 6 F205—F206
- Torpex 9 T324, T328—T329
analytical techniques 9 T328
preparation 9 T328
subsequent history 9 T328—T329
- Totalit (Swiss) 9 T329
- Touillage or detolitation (Fr) 9 T329
- Toval 9 T329
- Tovex 9 T329—T330
Drivex 9 T330
Pourvex extra 9 T330
Tovex 90, 100, 200, 300, 500, 6500, 650,
700, 800, C, Extra, P, S, T-1 9 T329—T330
- Tovite 9 T331
- TOW 7 T96; 9 T331
- Toxicology of expls and propnlts 9 T332—T345
, DNT (dinitrotoluene) 9 T338—T340
, glossary of toxicology terms 9 T340—T342
, introduction 9 T332
, methyl nitrate 9 T340
, Nitrocellulose (NC) 9 T337
, Nitroglycerin (Glyceryl Trinitrate, NG or
TNG) 9 T337—T338
, Nitroguanidine 9 T338
, RDX (Hexahydro-1,3,5-Trinitro-1,3,5-
Triazine) 9 T336—T337
, Tetranitromethane (TNM) 9 T340
, TNT (2,4,6-Trinitrotoluene) 9 T332—T336
, Refs for PETN 9 T345
, Refs for Picric Acid and Ammonium Picrate
9 T345
, Refs for propylene glycol dinitrate 9 T345

- Toxicology of expls and proplnts (cont'd)
 , Refs for Tetryl 9 T345
 , Refs for triethylene glycol dinitrate 9 T345
- Toxol 9 T346
- TPEON 9 T346
- TPX 9 T346
- Tracers (ICT), igniter compositions for 4 D774
- Tracers see Pyrotechnics 8 P508–P510
- Track torpedo 9 T346
- Trajectory, Projectile 9 T346–T347
- Tramex (Swiss) 9 T347
- Transformation of calorific energy to either
 chemical or mechanical energy see
 Berthelot theory of detonation 2 B106
- Transformation of chemical to calorific energy
 see Berthelot theory of detonation 2 B106
- Transformation of mechanical to calorific energy
 see Berthelot theory of detonation 2 B106
- Transition state theory 1 A4–A5
- Transmission electron microscopy 8 M127
- Transmission of detonation at a distance test
 1 X; 4 D395–D402
 air-gap test 4 D397–D398
 booster-gap expl sensitivity test of Cole &
 Edwards 4 D398
 card-gap sensitivity test of Cook et al 4 D398
 card test 4 D399
 coefficient de self-excitation 3 C390
 four cartridge test 4 D399
 gap test 1 XIV
 halved-cartridge gap method 1 XIV
 shock-pass-heat-filter 4 D399
 three-legged table sensitivity test 4 D399
 wax gap test 1 VIII
 whole cartridge sensitivity test 4 D399
- Transmission of detonation through an expl
 charge see Ability to propagate detonation
 1 VII
- Transport of hazardous materials see Safety in
 the energetic materials field 9 S10 (storage
 and transport); 9 T347
- Traulz Dynamite 9 T347
- Traulz test (lead block expansion test)
 1 XXV–XXVI; 2 B266–B295; 8 P365
- Tremonite S.11 9 T347
- Trempage des poudres (Fr) 9 T347
- Trench mortar 2 C28; 8 M156–M157
- Trench's expl 9 T347
- Triacetin (TA or glyceryl triacetate) see Acetins
 1 A31–A32; Proplnt, solid 8 P406–P407;
 9 T347
- Triacetone triperoxide (acetoneperoxide or
 trimeric) 1 A42–A45
- Triacetoneitrile oxide 8 N105
- Trialen, trialene or tetranol (Torpex)
 9 T324, T328–T329
- Triamine, diethylene 9 T348
- Triaminoguanidine, its nitrate and salts see
 TAGN 9 T28–T29
- 1,2,3-Triaminopropane and derivs 9 T348
 1,2,2-triaminopropane hydrochloride 9 T348
 1,2,3-Trinitroaminopropane (NGX or TNAPr)
 9 T348
- Triaminotetroxide, chromium 3 C302
- 2,4,6-Triamino-1,3,5-triazine see Cyanuramide,
 melamine or 2,4,6-triamine-sym-triazine
 3 C589
- 1,3,5-Triamino-2,4,6-Trinitrobenzene see TATB
 9 T34–T55
- s-Triazaborane (borazine, hexahydro-s-triaza-
 borine or triboron nitride) 9 T348–T349
- 1,3,5-Triaza cyclohexane, 1,3-dinitro-5-nitroso
 (NOX) see Hexahydro-1,3-dinitro-5-nitro-5-
 triazine 7 H75
- 1,3,5-Triaza cyclohexane-5-nitrate, 1,3-dinitro
 (PCX) see Hexahydro-1,3-dinitro-1,3,5-
 triazine nitrate, PCS 7 H75
- 2,4,6-Triazaheptane, 1,7-bis (difluoroamino)
 9 T349
- 2,4,6-Triazaheptane, 1,7-diacetoxy-2,4,6-trinitro
 (BSX) 5 D1119; 9 T349
- 1,3,5-Triaza-n-pentane-5-nitrate, 1,3-dinitro
 9 T349

- Triazenes see Hydronitrogens 7 H224;
 9 T349–T351
 N'-amino-N'-phenyl-N³-(tetrazolyl-5)-triazene
 1 A247–A248
 bis (tetrazolyl)-triazene 2 B158
 N-carboxamide-N-guanyl triazene 9 T350
 dimethyltriazene 5 D1376–D1377
 N-, N-di (3,5-dinitro-2-hydroxy toluene)
 tetrazene 9 T350
 1,3-diphenyl-triazene-(1) see Diazoamino-
 benzene 5 D1156
 N',N-diphenyl-N'-nitroso triazene 9 T350
 1,3-di [tetrazolyl-(5)-triazene] 5 D1157
 N'-hydroxy-N-azidoiminomethyltriazine see
 Diazoguanylazide 5 D1164
 1,3-di- α -naphthyltriazene see Diazoamino-
 naphthalene 5 D1158
 N'-phenyl-N-carboxylic acid amidide
 9 T350–T351
 N'-phenyl-N-hydroxy-N-p-aminophenyl-
 triazene 9 T351
 N'-phenyl-N-hydroxy-N-4-ethylaminophenyl-
 triazene 9 T351
 N'-phenyl-N'-oxy-N-benzene sulfonyl-
 triazene 9 T351
 N'-phenyl-N-toluene sulfonyl-N-benzene
 sulfonic acid triazene 9 T351
 N'-1-tetrazolyl-N-p-nitrophenyltriazene
 9 T351
- Triazides (inorganic) 1 A521–A625; Organic
 triazides 9 T352
 cyanuric triazide 3 C590–C591;
 9 T356–T357
 the triazide of Δ^2 pyrazoline-(3,4,5-)
 tricarboxic acid 9 T352
 the triazide of pyrazole-(3,4,5)-tricarboxic
 acid 9 T352
 1,3,5-triazido-2,4,6-trinitrobenzene (TNTAB)
 2 B43–B44; 9 T352
 tricarballylic acid triazide 9 T352
 tricarboxic acid triazide 9 T352
- 2,4,6-Triazido-mesitylene 8 M62
- Triazines 9 T352–T358
 asymmetrical or 1,2,4-triazines 9 T356
 symmetrical or 1,3,5-triazines 9 T356–T358
 vicinal or 1,2,3-triazines 9 T353–T356
- Triazoacetaldehyde 1 A15
- Triazoacetamide 1 A16
- Triazoacetanilide see Acetanilide, analytical
 derivs 1 A23
- Triazoacetic acid 1 A27
- Triazoacetone 1 A39
- Triazoacetylchloride 1 A57
- Triazoethane 6 E143
- Triazoethanol nitrate see Ethanol azido nitrate
 6 E177
- Triazoles 9 T358–T366
 1,2,3-triazoles, listing 9 T361–T362
 aminobenzotriazoles 1 A190–A191
 aminodimethyltriazoles 1 A196
 aminomethyltriazoles 1 A235–A236
 aminotriazoles 1 A267–A268
 amino triazolecarboxylic acids 1 A270
 aminotriazoledione 1 A270–A271
 aminotriazolopyrimidenes 1 A271
 aminotriazolopyrimidinols 1 A271
 benzeneazo-carboxyphenyltriazole
 2 B52–B53
 benzophenyltriazole 2 B78–B79
 benzotriazole 2 B87
 benzotriazolol 2 B87–B89; 9 T359–T360
 benzyltriazole 2 B101
 (3'-carboxypyrido)-5',6':4,5-vic (or 1,2,3)-
 triazole 2 C66
 4-carboxy- α -vic (or 1,2,3-triazole) 2 C67
 4,5-dicyano-1,2,3-triazole 5 D1219
 diphenyltriazole 5 D1485–D1487
 1-hydroxy-6-aminobenztriazole 7 H231
 3-imino-5-phenylimino-1,2,4-triazoline
 7 I34–I35
 2-methyl-4-bromo-1,2,3-triazole 9 T360
 4-nitro-1H-1,2,3-triazole 9 T360
 [2'-phenyl-2',1',3'-triazolo]-4',5':4,5-
 [1,2,3-triazole] 9 T360
 1-picryl-1H-1,2,3-triazole 9 T360–T361
 1-picryl-4-nitro-1H-1,2,3-triazole 9 T361
 2-picryl-2H-1,2,3-triazole 9 T361
 2-picryl-4-nitro-1H-1,2,3-triazole
 9 T361–T362
 1,2,4-triazoles, listing 9 T362–T366
 acetamidotriazole 1 A22
 allyl triazole 1 A139–A140
 aminoethyltriazoles 1 A207–A209
 aminoguanazole 1 A209–A210
 aminohydrazinomercaptotriazoles 1 A216
 aminomethyltriazoles 1 A235–A237

Triazoles (cont'd)

3-amino-5-picrylamino-1,2,4-triazole 9 T362
 aminotriazoles 1 A268–A270
 aminotriazole-carboxylic acids 1 A270
 aminotriazolidione 1 A270–A271
 aminoxytriazoles 1 A240
 3-azido-1,2,4-triazole 9 T362–T363
 benzyltriazole 2 B101
 bis (β -sym or β -1,2,4-) triazole 2 B159–B160
 carboxytriazole 2 C66–C67
 diaminotriazole 5 D1148–D1149
 3,5-dichloroimino-4,1,2-triazole 9 T363
 4-(2,4-dinitrobenzyl)-3,5-dinitrotriazole
 9 T363
 3,5-dinitro-1 (4)-methyl-1,2,4-triazole 9 T363
 3,5-dinitro-1,2,4-triazole 9 T363–T364
 diphenyltriazole 5 D1485–D1487
 ethyltriazole 6 E335–E336
 [2'-hydroxynaphthyl]-1'-azo-3-[5-azido-
 1,2,4-triazole] 9 T364
 5-nitro-3-oxy-1,2,4-triazole 9 T364
 [3-nitrosamino-5-azido]-1,2,4-triazole 9 T364
 3-nitrotriazole 9 T365
 3-(picrylamino)-1,2,4-triazole 9 T365
 4-picryl-3-picrylamino-1,2,4-triazole 9 T365
 2-picryl-3-picrylamino-1,2,4-triazole 9 T365
 1-picryl-1,2,4-triazole 9 T365–T366
 [pyrido]-1',2',4,5-[4,1,2-triazole] 9 T366
 1,2,4-triazole-1-acetamide 1 A22

Triazomethane 8 M66

Triazonitroaminomesitylene 1 A225

Tribenzonitrile 8 N105

Tribenzonitrile oxide 8 N105

Tribochemistry and the initiation of explns see
 Detonation, spot or hot spot initiation of
 4 D563–D569; Hot spots 7 H170–H175;
 Impact, initiation or expln by 7 I43–I48;
 9 T366

2,4,6-Tribromobenzene, 1,3-dinitro 9 T366

2,4,6-Tribromo benzoic acid diazonium nitrate
 9 T366

Tributylborane 9 T55

Trichloride, nitrogen 8 N122

6,6,7 (or 4,5,5)-Trichloro-4,5 (or 6,7)-dioxo-
 4,5,6,7-tetrahydro-benzotriazole 3 C258

Trichloromethanephosphonic acid 9 T366–T367

Trichloromethyl perchlorate 9 T367

Trichloronitromethane 8 M73

1,1,1-Trichloro-3-nitropropane-(2) 8 P475

1,1,1-Trichloro-3,4,5-pentanetriol trinitrate
 9 T367

1,1,2-Trichloro-1,2,2-trifluoroethane 6 F149

1,3,5-Trichloro-2,4,6-trinitrobenzene 9 T367

Trichromates 3 C288

Trichromates, listing 3 C288–C289
 ammonium trichromate 3 C288
 potassium trichromate 3 C288
 sodium trichromate 3 C288

Tricinat or Tirzinat (Ger) see Normal lead
 styphnate 5 D1278 ff; 9 T367

Tricycloacetone peroxide 1 A42–A45

Tridecane, 2,2,4,7,7,10,12,12-octanitro-4,10-
 diaza 9 T367

Trident 9 T367

Tridites 9 T368

Triethanolamine tetranitrate 9 T368

Triethyl Al see TEA 9 T55–T56

Triethylaluminum etherate 9 T368–T369

Triethylamine perchlorate 9 T369

Triethylammonium nitrate 9 T369

Triethylborane see TEB 9 T56

Triethyleneglycoldinitrate see TEGDN
 9 T56–T59

Triethylenetetramine see TETA 9 T70

Triethyl lead azide 9 T369

Triethyllead-mono-ethyl-oxalate 9 T369

Triethylmonosilane 9 S86

2,2,2-Trifluoroethylguanidine nitrate 6 G166

2,2,2-Trifluoroethylguanidine picrate 6 G166

Trifluoroethyl Tetryl see TFEt Tetryl 9 T167

Trifluoroguanylfluoride 6 G172–G173

Trifluoronitromethane 8 M72

Trifluoronitrosomethane 6 F149

- 3,3,3-Trifluoro-1,2-propane dinitrate
9 T369–T370
- Trifulmin 8 N105
- Triginato (Span) 9 T370
- Triglycolamidic triazide 9 T370
- 2,4,6-Triguanidino-s-triazine 6 G168
- Trihydrazine nickel (II) nitrate see
Nickelhydrazine nitrate complex 8 N26;
9 T370
- 4,5,2'-Trihydroxy-2-methylanthraquinone,
1,3,6,8-tetranitro 9 T370
- Triisobutylborane 9 T370
- Trilita (Span) see Spanish expls and ammunition
9 S164–S175
- p-N,N-Trilithioaniline 1 A407
- Trilons see Dimethylaminocyanophosphoric acid,
monomethylester of 5 D1308–D1309
- Trimeric acetone peroxide 1 A42–A45
- 3,4,8-Trimethoxyphenanthrene-5-carboxylic
acid azide 8 P224
- Trimethyl Al see TMA 9 T231–T232
- Trimethylamine see TMA 9 T232–T233
- Trimethylamine oxide perchlorate 9 T371
- Trimethylammonium nitrate 9 T371
- Trimethylammonium perchlorate 9 T371
- 3,4,5-Trimethylaniline 1 A215
- Trimethyl-o-anisidinium perchlorate 9 T371
- Trimethylbenzene and derivs see Mesitylene
8 M61–M63
- Trimethylene 3 C605
- Trimethylene-1,3-dinitramine 9 T372
- Trimethylene-1,2-dinitrate see 1,2-Dinitramino-
propane 5 D1142
- Trimethylene-dinitrate, 2,2-dinitro 9 T372
- Trimethyleneglycol dinitrate 8 P399–P400
- Trimethylene glycol diperchlorate 9 T372
- Trimethyleneimine 1 A518–A519
- Trimethylene peroxide azine 9 T372
- Trimethylene-1,2,3-triketoazide 9 T372
- Trimethyl glycine see Betaine 2 B107
- 1,2,3-Trimethyl-2-nitropropanediol-1,3-dinitrate
9 T372
- 1,1,1-Trimethylolbutane trinitrate 9 T373
- 1,1,1-Trimethylol-2-chlorethane trinitrate
8 M117
- 1,1,1-Trimethylolethane trinitrate see Metriol
trinitrate 8 M120–M121
- Trimethylolmethylethane and derivs
8 M116–M117
- Trimethylolnitromethane see Trimethylolmethane
2 B371
- Trimethylolnitromethane trinitrate
2 B371–B372; see Nitroisobutylglycerol
trinitrate 8 N112–N113
- 1,1,1-Trimethylolpropane trinitrate 9 T373
- 2,4,6-Trimethylpyrylium perchlorate
9 T373–T374
- Trimethylsulfine chlorate 2 C201; 9 T374
- Trimethylsulfonium perchlorate 9 S240
- Trimethyltoluidinium perchlorates 9 T374
- 2,4,6-Trimethyl-1,3,5-trioxane 1 A14
- Trimolecular acetone peroxide 1 A42–A45
- Trimonite 9 T374
- Trinal see Trinitronaphthalene 8 N12–N14
- Trinilina or trinitralina (Span) see Trinitro-
aniline 1 A409–A411
- Trinitril or Trinitryl see Glycerol- α -[2,4,6-
trinitrophenylether] dinitrate 6 G109–G110
- Trinitroabietic acid 1 A3
- Trinitroacetamide 1 A17
- Trinitroacetamidoanisole 1 A17–A18
- Trinitroacetamidonaphthalenes 1 A20
- Trinitroacetamidophenetole 1 A20
- Trinitroacetamidophenols 1 A21
- 2,4,6-Trinitro-3-acetamidotoluenes 1 A22

- Trinitroacetanilides 1 A24
 Trinitroacetonitrile 1 A46
 Trinitroacetophenones 1 A48
 Trinitroacetoxy diphenylamine 1 A51
 Trinitroacetyldiphenylamine 1 A58
 2,4,7-Trinitro-9-(IDH)-acridone 1 A96
 Trinitroaminoanisoles 1 A182
 Trinitroaminobiphenyls 1 A191
 Trinitroaminodiphenylamines 1 A197
 3,2',4'-Trinitro-4-aminodiphenylether 1 A199
 Trinitroaminomethylbiphenyls 1 A229
 Trinitroaminomethyldiphenylamines 1 A230
 Trinitroaminonaphthalenes 1 A237
 Trinitroaminophenetoles 1 A240–A241
 Trinitroaminophenols 1 A244
 2,4,6-Trinitro-5-aminoresorcinol 1 A257
 2,4,6-Trinitro-3-aminotoluene 1 A265
 2,4,6-Trinitro-5-amino-m-xylene 1 A272–A273
 Trinitroanhydrodiacetoneurea 1 A403–A404
 Trinitroanilines (TNA) 1 A409–A411; 9 T375
 2,4,6-Trinitroanilinoacetic acid 1 A420
 Trinitroanilinoazobenzene 1 A420
 m-(2,4,6-Trinitroanilino)-benzonitrile 1 A422
 2-(2',4',6'-Trinitroanilino)-ethanol 1 A425
 N-[2-(2,4,6-Trinitroanilino)-ethyl]-aminoethanol
 nitrate 1 A431
 6-(2',4',6'-Trinitroanilino)-indazole 1 A432
 α -(2,4,6-Trinitroanilino)-isovaleric acid 1 A442
 Trinitroanilinophenols 1 A433
 Trinitroanilinopropanediols 1 A435
 2,4,6-Trinitroanilinosuccinic acid 1 A437
 5-(2',4',6'-Trinitroanilino)- α (or 1H)-tetrazole
 1 A437–A438
 Trinitroanilintoluenes; trinitrodiphenylmethyl-
 amines 1 A438–A439
 Trinitroanilinoxylenes 1 A443
 Trinitroanisole complex 1 A453
 Trinitroanisoles (TNAns) 1 A450–A453
 Trinitroapigenins 1 A474
 2,4,6-Trinitrobenzaldehyde 2 B35
 2,4,6-Trinitrobenzaldehyde-(2,4-dinitrophenyl-
 hydrazone) 2 B37–B38
 2,4,6-Trinitrobenzaldehyde-(4-nitrophenyl-
 hydrazone) 2 B37
 2,4,6-Trinitrobenzaldehydeoxime 2 B36
 2,4,6-Trinitrobenzaldehydophenylhydrazone
 2 B37
 2,4,6-Trinitrobenzaldehydesemicarbazone 2 B38
 2,4,6-Trinitrobenzamide 2 B39
 Trinitrobenzanilide 2 B40
 Trinitrobenzene, sym (TNB) 2 B48–B50;
 9 T375–T378, T379
 Trinitrobenzeneazonaphthalene 2 B53
 Trinitrobenzeneazonaphthol 2 B54
 2,3,6-Trinitrobenzene-4-diazo-1-oxide 2 B60
 2,4,6-Trinitrobenzenesulfonic acid 2 B62
 2,4,6-Trinitrobenzenethiol 2 B63
 2,5,3'-Trinitrobenzidine 2 B64
 Trinitrobenzimidazolone 2 B66
 Trinitrobenzodioxan 2 B67
 Trinitrobenzoic acids 2 B73–B75
 Trinitrobenzophenone 2 B76
 Trinitrobenzophenyltriazole 2 B78–B79
 2,3,5-Trinitrobenzoquinone-1-imino-4 (?) -
 trimethylimine 2 B83
 2,4,6-Trinitrobenzotrifluoride see TNTF 9 T298
 2,4,6-Trinitrobenzoylchloride 2 B90
 Trinitrobenzyl alcohol 2 B92
 Trinitrobenzylaniline 2 B93
 Trinitrobenzyl chloride 2 B95

- 4-(2,4,6-Trinitrobenzylideneamino)-phenol
2 B97
- Trinitrobenzylideneaniline 2 B97
- 2,4,6-Trinitrobenzyl nitrate 2 B92
- N-(2,4,6-Trinitrobenzyl)-3'-nitroaniline 1 A229
- Trinitrobenzylpyridine 2 B100
- Trinitrobenzyltoluidine 2 B101
- 2',4',6'-Trinitrobenzyl-2,4,6-trinitro-nitraniline
2 B94
- Trinitrobicresol 2 B112
- 1,5,4' (or 1,5,5')-Trinitroimidazole 2 B115
- Trinitrobiphenyl 2 B123–B124
- Trinitrobiphenyldicarboxylic acid 2 B126
- Trinitrobromoazobenzene 2 B308
- Trinitrobromoazoxybenzene 2 B308
- Trinitrobromobenzene 2 B309
- Trinitrobromomethane 2 B312–B313
- Trinitrobromomethylaniline 2 B314
- Trinitrobromophenol 2 B315
- Trinitrobromotoluene 2 B317
- 1,1,1-Trinitrobutane 2 B367
- 1,1,1-Trinitrobutanol 2 B374
- Trinitrobutene 2 B376
- Trinitrobutyramide 2 B391; 9 T380
- Trinitrobutyrate, 2,2-dinitropropyl (DNPTB)
8 P480
- Trinitrobutyric acid 2 B392
- Trinitrobutyric acid derivs 2 B392
- Trinitrobutyric acid ester of 2,2-dinitro-1,3-
propyleneglycol 9 T380
- Trinitro-C-butyl-aminotoluene 2 B377
- Trinitro-N-butylaniline 2 B379
- Trinitrobutylanisole 2 B380
- Trinitrobutylbenzamide 2 B380
- Trinitrobutylbenzene 2 B380
- Trinitrobutylcresol 2 B381–B382
- 4,6,7-Trinitro-5-(tert-butyl)-hydrindene 2 B384
- Trinitrobutylmethylanisole 2 B386
- 2,3,5-Trinitro-4-(N-butyl-N-nitro)-aminotoluene
2 B378
- 2,3,5-Trinitro-4-(N-butyl-N-nitroso)-amino-
toluene 2 B378
- Trinitrobutylphenol 2 B388
- Trinitrobutyltoluene 2 B389
- Trinitrobutylxylene 2 B390
- Trinitrobutyramide 2 B391
- Trinitrobutyronitrile 2 B393
- Trinitrocarbanilic acid esters 2 C43–C44
- Trinitrocarbanilide 2 C44
- 3,4,6 (or 3,5,6)-Trinitro-2-carboxyhydro-
cinnamic acid 2 C65
- Trinitrochalcones 2 C146
- Trinitrochloroanilines 3 C247
- Trinitrochloroanilinopropanediol dinitrates
3 C247–C248
- Trinitrochloroanisole 3 C248
- Trinitrochlorobenzenes 3 C250–C251
, analytical procedures 3 C251
- Trinitrochlorohydroxyanisole 3 C257
- Trinitrochloromethane 3 C259
- Trinitrochloromethylaniline 3 C261
- Trinitrochlorophenol 3 C262–C263
- 2,4,6-Trinitro-3-chlorotoluene 3 C272
- Trinitrochloroxylene 3 C273
- 3,6,8-Trinitrocoumarin 3 C551
- 2,4,6-Trinitro-m-cresol 3 C559
- Trinitrocresols 3 C557
- 2,4,6-Trinitrocumene 3 C574
- X-Trinitro-2-cyclohexyltoluidine 3 C601
- Trinitro derivs (& salts) of dihydroxybenzene
5 D1276–D1288
- 2,4,6-Trinitro-1,3-diaminobenzene (DATB or
DATNB) 5 D1130–D1131

- 2,4,6-Trinitro-3,5-diaminophenol 5 D1142
 2,4,6-Trinitro-3,5-diaminotoluene 5 D1146
 Trinitrodibenzofurans 5 D1183
 1,3,5-Trinitro-2,4-dibromobenzene 5 D1192
 2,4,6-Trinitro-3,5-dibromophenol 5 D1195
 Trinitrodichloroazoxybenzene 5 D1206
 2,4,6-Trinitro-1,3-diethylbenzene 5 D1228
 2,4,6-Trinitro-1,3-difluorobenzene (TNDFB or DFTNB) 5 D1259
 2,4,6-Trinitro-1,5-dihydroxynaphthalene 5 D1294
 2,4,6-Trinitro-3,5-dihydroxytoluene 5 D1296
 Trinitrodimethoxybenzenes 5 D1302
 Trinitro-dimethoxy toluenes 5 D1305
 4,6,4'-Trinitro-3-dimethylaminoazobenzene 5 D1307
 3,X,X-Trinitrodimethylamino-p-benzoic acid 5 D1308
 2,4,6-Trinitro-3-dimethylaminophenylmethyl nitrosamine 5 D1311
 2,4,6-Trinitro-3,5-dimethyl-1-aniline 5 D1317
 Trinitro-N,N-dimethylanilines 5 D1315
 Trinitrodimethylanisole 5 D1319
 Trinitrodimethylbenzenes 5 D1324
 Trinitrodimethylbenzophenone 5 D1327
 2,4,6-Trinitro-1,3-dimethyl-5-tert-butylbenzene 5 D1331
 3,5,8-Trinitro-6,7-dimethylcoumarin 5 D1332
 2,4,6-Trinitro-3,5-dimethylcumene 5 D1333
 2,4,6-Trinitro-3,5-dimethyl-1-dinitroaniline 5 D1317
 2,4,7-Trinitro-1,3-dimethyl-9-fluorenone 5 D1339
 X,X,X-Trinitro-2,5-dimethylhexane 5 D1343
 1,4,5 (?) -Trinitro-2,6-dimethylnaphthalene 5 D1350
 2,4,6-Trinitro-1,3-di (methylnitramino) benzene (Ditetryl) 9 T380
 Trinitrodimethylphenylhydrazine 5 D1366
 2,4,6-Trinitro-1,3-di (N-nitro- β -ethanolamine)-benzene 5 D1242–D1243
 2,3,6-Trinitro-1,3-di (β -nitroxyethyl)-benzene 5 D1228
 2,4,6-Trinitro-1,3-di (β -nitroxyethyl) benzene 9 T380
 Trinitrodiphenylamines 5 D1432–D1433
 Trinitrodiphenyldisulfide 5 D1450
 Trinitrodiphenylethers 5 D1452
 Trinitrodiphenylethylene 5 D1455
 Trinitro-7,8-diphenylglycoluril 5 D1462
 Trinitrodiphenylmethane 5 D1465–D1466
 Trinitro-N,N'-diphenylphenylenediamine 5 D1471
 Trinitrodiphenylsulfides 5 D1477
 Trinitrodiphenylsulfones 5 D1479
 Trinitro-2,4-diphenyl-2,1,3-triazole 5 D1486
 2,4,6-Trinitro-N,N-dipropylaniline 5 D1495
 3,5,5'-Trinitro-(di- α -pyridylamine) 5 D1502–D1503
 2,2,2-Trinitroethanol, 1-phenyl 9 T380–T381
 1,1,1-Trinitro-2-ethoxy pentane (TNEP) 6 E193
 2,3,6-Trinitro-4-ethoxy phenyl urethane 6 E194
 N-(2,2,2-Trinitroethyl) acetamide 6 E195
 N-(β , β , β -Trinitroethyl)-acetamide 9 T381
 Trinitroethylacrylate 6 E202
 β -Trinitroethyl alcohol 6 E179–E180; 9 T381
 Trinitro-N-ethylaminophenols 6 E204–E205
 Trinitro (ethylamino) toluenes 6 E335
 Trinitro-N-ethylanilines 6 E206
 N-(2,2,2-Trinitroethyl) azidoacetamide 6 E195
 N-Trinitroethylbenzene sulfonamide 6 E214; 9 T381
 Trinitroethylcarbamate 6 E218
 2,2,2-Trinitroethylcarbamic acid, 2,2,2-trinitro-ethylester 6 E218

- (Trinitroethyl) carbonate, bis (BTNEC) 9 T381
- N-Trinitroethyl-N-cyanomethyl nitramine 6 E224
- 2,2,2-Trinitroethyl-3,5-dinitrobenzoate 6 E215; 9 T381–T382
- 2,2,2-Trinitroethyl-4,4-dinitropentanoate (TNEDNP) 6 E316
- 1-(2,2,2-Trinitroethyl)-2-(2,4-dinitrophenyl)-hydrazine 6 E322
- Trinitroethyl-3,5-dinitrosalicylate 6 E330
- Trinitroethylethylenediamine, N,N-nitro, di 9 T382
- Trinitroethyl formal see TEFO 9 T56
- Trinitroethylglycolate nitrate 6 E296
- 2,4,6-Trinitro-N-ethyl-iso-propylaniline 6 E327
- 4,4,4-Trinitro-ethyl-iso-valerate 6 E339
- Trinitroethyl-methanesulfonamide 6 E308
- Trinitroethylmethylbenzenes 6 E310
- N-Trinitroethyl-nitrobenzene sulfonamides 6 E214; 9 T382
- (2,2,2-Trinitroethyl)-nitramine, bis (BTNEN) 5 D1224–D1225; 9 T382
- 1-(2,2,2-Trinitroethyl)-2-nitramino-2,3-imidazole 6 E204
- N-Trinitroethyl-p-nitrobenzenesulfonamide 9 T382
- 2,2,2-Trinitroethyl-m-nitrobenzoate 6 E215; 9 T382
- N-(2,2,2-Trinitroethyl)-N'-nitro-N'-(3,4-dinitrophenyl) urea 6 E323
- 2,2,3-Trinitro-3-ethylpentane 6 E315
- N-(2,2,2-Trinitroethyl)-N'-phenylurea 6 E323
- Trinitroethyl salicylate 6 E329
- Trinitroethyl stearate 6 E330
- 2,2,2-Trinitroethyl-2,4,6,6-tetranitro-2,4-diazahexptane 6 E225
- N-Trinitroethyl-p-toluene sulfonamide 6 E334
- 2,2,2-Trinitroethyl-p-toluene sulfonate 6 E334
- Trinitroethyltoluenes 6 E333
- Trinitroethyl-2,5,5-trinitro-2-azahexanoate 6 E207
- 2,2,2-Trinitroethyl-2,4,6-trinitrobenzoate 6 E215; 9 T383
- N-(2,2,2-Trinitroethyl)-4,4,4-trinitrobutyramide 6 E216; 9 T383
- 2,2,2-Trinitroethyl-4,4,4-trinitrobutyrate (TNEtTNBu or TNETNB) 6 E217; 9 T383
- 2,2,2-Trinitroethyl-4,6,6-trinitro-2,4-diazahexptanoate 6 E225
- 1-(2,2,2-Trinitroethyl)-2-(2,4,6-trinitrophenyl)hydrazine 6 E322
- 2,2,2-Trinitroethyl-3,3,3-trinitropropylamine 6 E326
- N-(2,2,2-Trinitroethyl)-N-(3,3,3-trinitropropyl)-nitramine 6 E326
- N-Trinitroethylurea 6 E337
- Trinitroethylurethane 6 E337
- Trinitro-ethyl-o,m,p-xylenes 6 E340–E341
- Trinitro-(N-ethyl)-m or p-xylidine 6 E341
- Trinitrofluoranthene 6 F120
- Trinitrofluorenones 6 F123
- Trinitroglycerin (Nitroglycerin, Glycerol Trinitrate or NG) see Continuous methods for manufacturing of expls 3 C501–C506; 5 D1593–D1594; 6 G98–G108; 8 N56–N62; Nitration N40, Proplnts, solid P405 ff; 9 T383–T388
- , expls analysis 9 T383–T384
- , general 9 T383
- proplnts (including); combustion mechanisms 9 T384–T387, manufacture 9 T387–T388, new proplnt compositions 9 T388, parameters measurements 9 T388.
- Trinitroguaiacols 6 G147–G148
- Trinitroheptanes 7 H62–H63
- 4,6,6-Trinitroheptanoic acid, methyl ester 7 H63–H64
- 2,4,6-Trinitro-3-hydrazinotoluene 7 H210

- 2,4,6-Trinitro-1-hydroxybenzene-(3 azo 1)-2-naphthol 7 H236
- 2,4,6-Trinitro-3-hydroxybenzoic acid 7 H237–H238
- Trinitrohydrazobenzenes 7 H211
- Trinitrohydroquinonedithylether 7 H228
- Trinitrohydroxyazobenzene 7 H233
- Trinitrohydroxybenzophenyltriazole 2 B79
- Trinitro-hydroxy quinolines 7 H250
- 1,3,5-Trinitro-2-iodobenzene 7 I122
- 2,4,6-Trinitro-N-(iso-propyl)-aniline 8 P479
- 2,4,6-Trinitro-N-(iso-propyl)-N-nitraniline 8 P480
- Trinitromannan 8 M12
- Trinitromelamine 8 M56
- 2,4,6-Trinitro-mesitylene 8 M62
- Trinitromethane (nitroform or TNMe) 8 M78–M81
- 1,6,8-Trinitro-2-methylaminonaphthalene 8 M109
- Trinitro methyl anisoles 8 M104
- 2,3,3-Trinitro-2-methylbutane 9 T389
- Trinitromethylnaphthalenes 8 M109
- 2,4,6-Trinitro-3-methylnitraminoaniline (m-Amino Tetryl) 9 T389
- 2,4,6-Trinitro-3-methylnitramino-diphenylamine 1 A230
- 2,4,6-Trinitro-3-methylnitraminophenetole 9 T389
- 2,4,6-Trinitro-3-methylnitraminophenol (Oxy Tetryl or m-Hydroxy Tetryl) 9 T389
- 2,4,6-Trinitro-3-methylnitraminotoluene (methyl-CE or Methyl Tetryl) 5 D1375–D1376
- 2,2,3-Trinitro-3-methylpentane 9 T389–T390
- 2,4,6-Trinitromonomethylaniline 8 M101
- Trinitro-1-naphthols 8 N19–N20
- Trinitro-2-naphthols 8 N20
- 2-(2',4',6'-Trinitro-N-nitranilino)-iso-butyric acid 1 A423–A424
- 2-(2',4',6'-Trinitro-N-nitranilino)-ethanol nitrate (Pentryl) 1 A425–A429
 , energetic properties 1 A425–A429
 , history and preparation 1 A425
 , homologs 1 A429
 , physical properties 1 A425
 , solubility 1 A428
 , storage 1 A428
 , surveillance test 1 A428
 , toxicity 1 A428
- 2-(2',4',6'-Trinitro-N-(nitranilino)-2-methyl-1,3-propanediol dinitrate 1 A433
- Trinitro-N-nitranilinopropanediol dinitrates 1 A435–A436
- Trinitro-3-pentadecylphenol 8 P80
- 1,1,1-Trinitro-2-pentylpropargyl ether see Dipropargylbutyralnitroform product 5 D1492
- Trinitrophenetoles 8 P227–P228
- Trinitrophenol see "Picric Acid" 8 P285
- α -Trinitrophenol-dinitroglycerin see Glycerol- α (2,4,6-trinitrophenylether)-dinitrate 6 G109
- Trinitrophenols 8 P232–P233
- Trinitrophenolsulfonic acids 8 P235
- β -(2,4,6-Trinitrophenoxy) ethanol nitrate 8 P236–P237
- 2,4,6-Trinitrophenoxyethyl nitrate 8 P236–P237
- 2,4,6-Trinitrophenylbutylnitramine see Butyl Tetryl 2 B379
- 2,4,6-Trinitrophenyl (β,γ -dinitroxy) propyl-nitramine 8 P245
- 2,4,6-Trinitro-m-phenylenediamine 8 P240
- β -[2,4,6-Trinitrophenyl] ethanol 8 P241
- β -[2,4,6-Trinitrophenyl] ethanol nitrate 8 P241
- 2,4,6-Trinitrophenylethylnitramine see Ethyl Tetryl 6 E207, E319
- 2,4,6-Trinitrophenylguanidine 8 P242
- 2,4,6-Trinitrophenylhydrazine 7 H207

- 2,4,6-Trinitrophenylmethoxy nitramine **8** P242
- 2,4,6-Trinitrophenyl-(1-methylol) propyl-nitramine nitrate **8** P245
- 2,4,6-Trinitrophenylnitramine **8** P243
- Trinitrophenylnitraminoethylnitrate (Pentryl) **1** A425–A429
- [2,4,6-Trinitrophenylnitramino]-tris-(hydroxymethyl) methane trinitrate **9** T390
- N-2,4,6-Trinitrophenyl-N'-nitroguanidine **8** P242
- 2,4,6-Trinitrophenyl- β,β,β -trifluoroethyl-nitramine see TFEt **9** T167
- Trinitrophenylglucinol and lead salt **8** P248–P249
- 2,4,6-Trinitro-m-phthalic acid **8** P264
- α,β,β -Trinitro-propionaldehydeanil (Ger) **8** P477
- α,β,β -Trinitro-propionaldehyde, dipotassium salt of **8** P476–P477
- α,β,β -Trinitro-propionaldehyde methyl imide **8** P477
- 3,3,3-Triiodopropionic acid **8** P478
- Trinitropropyl acetate **9** T390–T391
- 1,1,1-Trinitro-2-propyl acrylate **8** P479
- Trinitro propyl bromide **8** P480
- Trinitrostilbazole perchlorates **9** S215
- 2,4,6-Trinitrostilbene **5** D1455
- 2,4,6-Trinitrostyrene **9** S224
- 2,4,6-Trinitro-3,5,3',5'-tetramethyl-diphenylamine **5** D1526
- 2,4,6-Trinitrotoluene see TNT **9** T235–T298
- 2,4,6-Trinitro-toluene, ω -chloro see Benzyl chloride **1** B95
- 2,4,6-Trinitrotolyl-3-methylnitramine see Methyl Tetryl **8** M116
- 2,4,6-Trinitro-1,3,5-triaminobenzene see TATB **9** T34–T55
- 1,3,5-Trinitro-1,3,5-triazacyclohexane see RDX or Cyclonite; Cyclotrimethylenetrinitramine **2** C611–C630; RDX **9** R120–R146
- 1,3,5-Trinitro-4-(2,2,2-trinitroethyl)-benzene **6** E213
- 2,4,6-Trinitro-1,3,5-tris (methylnitramino) benzene (Tri-Tetryl) **9** T391
- Tri (β -nitroxyethyl) ammonium nitrate **9** T391
- Trinitroxylene, commercial (TNX) **5** D1324–D1325
- Trinitryl **9** T391
- Trinol see Trinitroanisole **1** A450–A453
- Triogen see Cyclotrimethylenetrinitrosamine **3** C630–C632
- sym-Trioxane **6** F164–F165
- Trioxigen difluoride (fluorine ozonide) **6** F135; **9** T391–T392
- Tripentaerythritol Octanitrate (TPEON or Nitropenta) **9** T392–T393
 , expl properties of **9** T392–T393
 , hygroscopicity of **9** T393
 , preparation of **9** T392
 , uses of **9** T393
 , vacuum stability of **9** T393
- Triperchromic acids **8** P173
- Trip flare see Flare **6** F64, F65 (table 1); Pyrotechnics **8** P506
- Trip flare M48 **2** B258
- Triphenylamine perchlorate **9** T393
- [I,III,V-Triphenyl] pentazene **8** P133
- Triplastita (Span) see Spanish commercial expls of nonpermissible type **3** C442
- Triplastite **9** T393
- Triple base propnt see Representative solid propnt types and their uses **8** P406–P408
- Triple point in blast see Blast effects due to reflected shock waves **2** B182, B183 (Fig)
- Tri-n-propylaluminum **9** T393
- Tris [1,2-bis (difluoramino)-ethyl] isocyanate **8** P334–P335
- 1-Tris (difluoroamino) methoxy-2,2,2-trinitro ethane (TMTNE or tris (NF₂) methoxy trinitromethane) **9** T393–T394

- Tris-[X,X-dinitro-4-methylphenyl]-methane
9 T394
- Tris-(hydroxy mercury)-acetaldehyde and salts
9 T394
chloratrimercuryacetaldehyde 9 T394
nitratomercuryacetaldehyde 9 T394
perchloratotrimercuryacetaldehyde 9 T394
- [Tris (hydroxymethyl) amino]-methane
trinitrate 9 T394–T395
- Tris (hydroxymethyl) nitromethane 9 T395
- Trisilane 9 S86
- Tris (methylnitraminomethyl) amine 9 T395
- Tris-(2-nitroethyl) phosphate 6 E323
- Trisol (Ger & Swiss) see 2,4,6-Trinitroanisole
1 A450–A452; 9 T395
- Tris (oxymercuri) acetaldehyde perchlorate
9 T395
- Tris (thionitrosyl) thallium 9 T395
- 1,3,5-Tris (2,2,2-trinitroethyl)-benzene 6 E214
- Tris (2,2,2-trinitroethyl) orthoformate
9 T395–T396
- Tris-(trinitroethyl) phosphate 6 E324
- [I,III,V-Tri-4-tolyl] pentazene 8 P133
- Tritex 2 9 T396
- Trithioborate rocket fuels 9 T396
- Tritolite and Tritolitol (Ital) 3 C627
- Tritolo (Ital) see Italian expls and related items
7 I180–I181
- Tri-p-tolylamine perchlorate 9 T396
tri-p-tolylaminium perchlorate 9 T396
- Tritonal 9 T396–T398
, analytical 9 T398
, origin of 9 T396
, preparation of 9 T398
, properties of 80/20 9 T396–T398
- Tritorite see Ghinijonet 6 G73
- Tri-trinal 9 T399
- Tri-1,1',3',1''-(2,4,6-trinitrophenyl) 9 T399
- Triumph safety powder see Courteille powder
3 C550
- Trivilene 9 T399
- Trixogen 9 T399
- Trixyl (Ger) 9 T399
- Trizen (Ger) 5 D1276; 9 T399
- Trizinal or trizinat (Ger) 5 D1277 ff
- Trobach priming mixture 9 T399
- Troisdorf powder 9 T399
- Trojamites 9 T400
- Trojan expl 9 T400
- Trojel and trojel EZ-POR 9 T400
- Tropylium perchlorate 9 T400
- Trotil or tol see Rus expls and related items
9 R184–R203; T400
- Trotten powder 9 T400
- Trotyl 9 T400
- Trous de mine (Fr) see Boreholes 2 B248
- Tschirmer expls 9 T400–T401
- Tsel 'tit 9 T401
- Tungsten 9 T401–T415
azide pentabromide 9 T413
azide pentachloride 9 T413
, fabrication techniques for 9 T401
, history of the discovery of 9 T401
, occurrence of 9 T401
, preparation of 9 T401
, properties of 9 T401–T403
tris-(phenyl Li)-tris (diethyl ether), triphenyl
9 T413
, uses of 9 T403–T413
- Tungsten carbide 1 A82
- Tungsten dioxide 8 O52
- Tungsten hexafluoride 6 F149
- Tunnel-gelatin 90–80% 9 T415
- Tunnelit (Rus) 9 T415–T416
- Turmeric powder expls 9 T416
- Turpentine, nitrated 9 T416
- Turpin's expls and proplnts see Explosifs et
poudres de Turpin, and Pyrodialytes
6 E366–E367

Turpinite 9 T416

Tuthilote 9 T416

Tutol 9 T416

Two-step expl shell 9 T416

Tyne (Afror) powder see Afror tyne powder
1 A109

"Type" expls see Jap expls, ammunition and
weapons 7 J56—J57

Types of jet propulsion engines 7 J78—J82

U

- U.D.C. (unit deflective charge) 10 U1
- UDMH see uns-Dimethylhydrazine
5 D1344–D1346; 7 H203–H204, Liquid
proplnts L40–L41 (table 3); Additional refs
10 U1–U25
 , accidents 10 U1–U2
 , analysis and detection 10 U2–U3
 , combustion of 10 U3–U4
 , compatibility 10 U4–Y17
 , general refs to 10 U1
 , ignition of 10 U17–U18
 , pollution from 10 U18–U19
 , properties of 10 U19–U21
 , sensitivity of 10 U22
 , toxicity of 10 U22
 , uses of 10 U22–U25
- Ugol'nyiye ammonity (Rus) see Coal mining
expls, permissible 3 C454; 10 U25
- Ulmate of ammonium (Fr) see Ammonium
ulmate 1 A381–A382
- “Ultimate” fuels for jets and rockets see
Exotic fuels, and Exotic proplnts 6 E350
- Ultrafine Ammonium Nitrate (UFAN) see
Ammonium Nitrate 1 A311–A340;
Additional refs 10 U25
- Ultrafine Ammonium Perchlorate (UFAP) see
Ammonium Perchlorate 8 P430–P433 (table 29),
Proplnts, solid P435–P437 (table 36);
Additional refs 10 U25–U26
 , ignition of 10 U25
 , proplnt burning rate stability 10 U25
 , proplnt combustion 10 U25
 , preparation of 10 U25–U26
- Ultramicroanalysis see Color reactions and
color reagents 3 C405–C420; Microanalysis
of expls 8 M123, Mass spectrometry M37;
Radioactive tracers 9 R104 ff, Spectroscopy
of energetic materials S178 ff, and Taggants
for expls T3 ff
- Ultrasonics in ordnance 10 U26–U32
 application of ultrasonics to crack diagnostics
10 U27–U29
 application of ultrasonics to proplnt
technology 10 U27–U29
 , fundamental principles of 10 U26–U27
- Ultrasonics in ordnance (cont'd)
 , introduction to 10 U26
- Ultraviolet radiation see Radiation effects on
expls, proplnts and pyrotechnics 9 R5 ff
- Ultraviolet spectroscopy see Spectroscopy of
energetic materials 9 S278 ff
- Umbrite see Italian expls 7 I181
- Unconfined blasts see Blast effects in air
2 B180–B182
- Undecane, 1,1,1,4,6,6,8,11,11,11-decanitro-4,8-
diazia 10 U32
- Undecanedioic acid and nitrated derivs
10 U32–U33
 4,4,6,6,8,8-hexanitro-undecanedioic acid
10 U33
 4,4,6,8,8-pentanitro-undecanedioic acid
10 U32–U33
- Underground blasts and blasting see Blast effects
in earth 2 B182–B183; Additional refs
10 U33
- Underwater commercial blasting 10 U33–U38
 , major types of shaped charge expl units
used in 10 U35–U37
- Underwater explns 10 U38–U81
 underwater expln measurement techniques
10 U43–U46
 underwater expln parameters, measured
10 U50–U57
 , energy partition and useful work of
10 U70–U78
 , general description and definition of terms
10 U38–U42
 , scaling laws 10 U46–U49
 , shock interactions 10 U78–U81
 , “standard” expl and test environment
10 U49–U50
 , theoretical considerations of 10 U57–U70
 , uses of 10 U42–U43
- Underwater mines see Mines (military)
8 M131–M133
- Underwater storage of smokeless powder
10 U81
- Unibel 10 U81

- Unicell-100 5 E90–E91; 10 U82
- Unifrax 10 U82
- Unigel 10 U82
- Unigex 10 U82
- Unikol 10 U82
- Unionite 10 U82
- Uniperox 60 10 U82–U83
- Unipruf 10 U83
- Unirend 10 U83
- Unit deflective charge see U.D.C. 10 U1
- US Bureau of Alcohol, Tobacco and Firearms see
Tagging of expls 9 T3 ff
- US Naval friction fuse composition 10 U83
- US Naval smokeless powder 10 U83
- US smokeless powders (San Francisco) 10 U83
- Unite-MB see Coefficient de viscosite des Nitro-
celluloses industrielles 3 C390
- Universal expl destructor, M10 10 U83
- Universal Italiana see Italian expls 7 I181
- Universal Powder Co chlorate expl 10 U83–U84
- Unloading and recovery of ammunition contents
see Reclamation of energetic material compo-
nents from ordnance ammunition 9 R146,
and Renovation of ammunition R156
- Unsymmetrical dimethyl hydrazine (UDMH) see
Dimethylhydrazine 5 D1344–D1346;
UDMH 10 U1–U25
- “up-and-down” method see Coal mining expls,
testing of permissibility 3 C376; Impact,
initiation of expln by 7 I36–I37; Primers
8 P378–P379 (table 1)
- Uracil and deriv 10 U84–U85
5-nitro uracil 10 U84–U85
- Uraform-AN see AN, fertilizer grade (FGAN)
1 A366
- Uranium 10 U85–U92
uranium alloys, military specifications for
10 U90
uranium and its alloys, shock properties of
10 U90
- Uranium (cont'd)
uranium compounds, thermodynamic
properties of 10 U90
uranium isotopes, separation of 10 U87–U88
uranium, non-nuclear applications of
10 U89–U90
uranium, nuclear rocket engines using 10 U90
uranium, reactor fuel cycles 10 U88–U89
- Uranium compounds 10 U93–U95
U borohydride 10 U93
U carbide 1 A83
U dicarbide 10 U93
U hexafluoride 6 F149; 10 U93
U hydride 10 U94
U nitride 10 U94
U tetrafluoride 6 F149
U-Zr alloy explns 10 U94
uranyl acetate 10 U94
uranyl B Co perchlorate 10 U94
uranyl nitrate 8 N39–N40; 10 U94–U95
uranyl perchlorate 8 P169
- Urate, ammonium 10 U95
- p-Urazine see 4-Aminourazole 1 A272; 10 U95
- Urbanski, Tadeusz (1901–) 10 U95
- Urea 10 U95–U102
, history of 10 U95–U96
, preparation of 10 U96–U98
, properties of 10 U98–U99
, uses of 10 U99–U102
- Urea addition compounds and salts
10 U102–U105
urea, bis (trinitropropyl) see Dipropyl ureas
5 D1501
urea Ca nitrate 10 U102
urea chromihexaurea chlorate 10 U102
urea chromi-hexaurea sulfatochlorate
10 U102
urea hexakis Ga (III) triperchlorate 10 U102
urea nitrate 10 U102–U103
urea perchlorate 10 U103–U104
urea picrate 10 U104
urea sodium nitrate 10 U104
- Urea condensation and polycondensation
products (resins) 10 U105
- Urea derivs formed by partial substitution
10 U106–U109
N-alkyl-N'-(5-tetrazolyl)-ureas and N,N-
dialkyl-N'-(5-tetrazolyl)-ureas 1 A132–A133

Urea derivs formed by partial substitution (cont'd)

N-allyl-N',N'-diphenylurea 1 A137
 aminoethylpropylureas 1 A206
 aminoethylureas 1 A209
 bis diphenylurea 2 B142
 bis (phenyl)-urea 2 B155–B156
 bis (2,2,2-trinitroethyl)-urea (BTNEU) see
 Diethylurea 5 D1254–D1255
 bis (1,1,1-trinitro-iso-butyl)-urea 2 B160
 biurea 2 B164
 carbanylurea see Biuret 2 B164
 centralites 2 C126–C140; 10 U106
 N,N'-dibutyl-N,N'-diphenylurea see
 Centralite, butyl 2 C140
 dibutylurea 5 D1200
 N,N'-diethyl-N,N'-diphenylurea see Centralites
 2 C127–C137
 diethylurea 5 D1254–D1255
 dihydrodiacetoneurea 1 A403–A404
 N,N'-dimethyl-N,N'-diphenylurea see
 Centralite 2 2 C137–C139
 dimethylphenylurea 5 D1366–D1367
 dimethylurea 5 D1378; 10 U106
 1,5-dinitrobiuret, salts 5 D1385
 N,N'-dinitro-N,N'-trimethyleneurea 7 H76
 diphenylacetyleneurea see Diphenylglycoluril
 5 D1461–D1462
 N,N'-diphenyliminourea 5 D1462
 N,N'-di (2-phenyl-5-tetrazoyl)-urea 4 D1482
 asym-diphenylurea see Acardite 1 A7–A8
 sym-diphenylurea 2 B155–B156; 5 D1487
 dipropylurea 5 D1501
 N,N'-di (tolyl)-ureas 5 D1520
 diurea see 4-Amino-urazole 1 A472; 5 D1523
 ethanol diphenylurea 6 E182
 ethylenebisurea 6 E233
 ethyleneurea 6 E291–E292
 N-ethyl-N'-methyl-N,N'-diphenylurea see
 Centralite 3 2 C139
 ethylphenylureas 6 E322–E323

Urea derivs formed by partial substitution (cont'd)

N-ethyl-N'-tolyl-N,N'-diphenylurea see
 Centralite 4 2 C140
 ethylurea 6 E337
 guanylurea see Dicyandiamide
 5 D1217–D1218; 10 U107
 glycolurea see Hydantoin 7 H188
 N,N-mesoxalyl urea 1 A134
 N'-methyl-N-N-diphenylurea see Acardite II
 1 A8–A11
 nitrourea 10 U108
 phenylurea 10 U108–U109

Urethanes and derivs see Carbamic acid

ethyl esters 2 C40–C42, picrylurethane C43;
 Diphenylurethane 5 D1487–D1488;
 Ethylurethane 6 E337–E338; Propylts, solid
 8 G116–G117; 10 U109

-Uril, glycol 1 A65–A66; 6 G117–G118;
 10 U109–U110

Urushioldimethyletherozonides 8 O72

US armed forces (hygroscopicity) test at 30°
 and 90% RH 7 H252

Use of the polytropic EOS 9 T215–T216

User test 6 E352

Uses of amines 1 A277

Uses of ammonium nitrate 1 A334

U.S. Government Printing Office (GPO) 6 G121

Uses of NG 6 G102–G103

Utilization of condemned or surplus military
 expls, propylts and pyrotechnics see
 Reclamation of energetic material com-
 ponents from ordnance ammunition
 9 R146, and Renovation of ammunition
 9 R156

UZI 10 U110–U111

- V-1 10 V1
- Vacuum stability test 1 XXVI; 10 V1-V2
- Vacuum-steam-pressure-test 10 V3
- Valve, expl calculation 10 V3
- Vanadium 10 V3-V5
 divanadium dedecarbonyl 10 V4
 V bis cyclopentadienyl acetylaceticacid ethyl ester perchlorate 10 V4
 V bis cyclopentadienyl isoselenocyanate 10 V4
 V carbide 1 A83
 V hydride 10 V4
 V pentafluoride 6 F150
 V trinitrate oxide 10 V4
 vanadyl azide dichloride 10 V4
 vanadyl triperchlorate 10 V5
- Vandal 10 V5
- Van der Waals (detonation) equation of state 4 D293
- Van Pittius expls see Pittius expls 8 P305
- Vapor expls 10 V6-V33
 , accidental fuel/air expls 10 V30-V32
 , damage potential of 10 V6-V17
 , detonation parameters 10 V17-V22
 , initiation stimuli of 10 V6
 , introduction to 10 V6
 , mechanisms of fuel/air expls 10 V22-V28
 , military applications of fuel/air expls 10 V28-V30
- Vapor phase nitration see Nitration 8 N48, M56; Nitromethane 8 M69
- Vapor pressure of expls 10 V33-V45
 data 10 V38-V40
 , heats of sublimation and vaporization 10 V40-V45
 , introduction to 10 V33-V34
 , methods of measurement 1 XXVI; 10 V34-V38
- Vapor taggants for expls see Tagging of expls 9 T13 ff
- VARICOMP 10 V46
- VE₄ see Italian expls 7 I181
- Vegetable and animal fats and oils, nitrated see Fats, fatty oils, tallows, butters, waxes and fatty acids 6 F8-F9
- Vegetable glue 6 G85
- Velocity, detonation 10 V47-V62
 data 10 V50-V62
 , factors that affect 10 V48-V50
 , measurement techniques for 10 V47-V48
- Velocity of detonation test 1 X; see Experimental determination of detonation velocity 4 D632-D640
- Velocity of explosively driven fragments 10 V63-V94
 ; applications of 10 V87-V90
 ; comparison of the Gurney formula with hydrodynamic calculations 10 V67-V72
 ; computation of $\sqrt{2E}$ 10 V93
 ; derivation of Gurney formula for a semi-infinite slab; 2-D configuration 10 V91-V93
 ; domain of validity of the Gurney formula 10 V83-V87
 ; effect of air at free boundary 10 V90
 ; effect of a rigid wall 10 V90-V91
 ; empirical determination of the Gurney constants $\sqrt{2E}$ and $\sqrt{2E'}$ 10 V72-V83
 ; Gurney constant for expl-inert mixtures 10 V93-V94
 , introduction to 10 V63
 ; the Gurney method 10 V63-V67
- Velocity, particle 10 V95-V108
 , applications of 10 V95
 , introduction to 10 V95
 , measurement methods 10 V95-V104
 , theoretical considerations of 10 V104-V108
- Velocity, projectile see Ballistic measuring methods 2 B5-B6; Chronoscopes 3 C304-C310; Muzzle velocity 8 M162-M163; 10 V108-V115
 , detecting devices for 10 V110-V115
- Velox gelatine 10 V115
- Velterines 10 V115
 veltérine Belgique 10 V115
 veltérine C 10 V115
- Veltex 10 V115-V116
 Veltex no 448 10 V116

- Vender, gelatine **10 V116**
- Vending **10 V116**
- Veratrol see Dimethoxybenzene
5 D1302–D1303
- Verge explosivstoffe (Swiss) **10 V116–V117**
- Vermiculite **10 V117**
- Verstarktes chromammonit (Ger) **10 V117**
- Vertes expls **10 V117**
- Vesely **10 V117–V118**
- VF **10 V118**
- Vibration, ground, generated by blasting
10 V118–V121
effects of seismic waves on structures from
10 V120–V121
production of vibration levels generated by
ground blasting **10 V119–V120**
- Vibration spectra see Spectroscopy of energetic
materials **9 S178 ff**
- Vibration tests **10 V121–V123**
transportation vibration test **10 V121–V123**
- Vibrite see Italian expls **7 I181**
- Vibrogel 1 and Vibronite B **10 V123**
- Vibromite **10 V123–V124**
- Vickers **10 V124–V125**
- Victor powder **10 V125**
- Victoria powder see Dahman, Johann, von and
Dahmenit A **3 D1**
- Victorite see Expl B & T no 21 **6 E395; 10 V125**
- Vieille, Paul (1854–1934) **10 V125–V126**
- Vieille test see Vieille, Paul **10 V125–V126**
- Vigilant **10 V126**
- Vigorine **10 V126**
- Vigorit **10 V126**
- Vigorites **10 V126**
- Viking powder **10 V126–V127**
- Vincent, Thomas K (1895–1956) **10 V127**
- Vincennite **10 V127**
- Vinsol **10 V127**
- Vinyls **10 V127–V129**
2,2-dinitropropylacrylate **8 N139–N140**
divinylacetylene **5 D1525–D1526**
divinylbenzene (DVB or vinylstyrene)
10 V127–V128
divinylether **5 D1526; 10 V128**
ethylacrylate **6 E201–E202**
ethylvinyl carbinol **6 E339**
ethylvinyl ether (vinylethyl ether) **6 E339**
ethylvinyl hexoate (vinyl-2-ethyl hexoate)
6 E339
ethylvinylhexyl ether **6 E339**
ethylvinylpyridine **6 E340**
methyl trifluorovinyl ether **10 V128**
2-methyl-5-vinyl tetrazole polymer see
Tetrazoles **9 T130–T131**
tetravinyl lead **9 T101**
1,1,1-trinitro-2-propyl acrylate **8 P479**
- Vinyl acetate and polyvinylacetate
8 P353–P354; 10 V129–V130
- Vinyl acetate ozonide **10 V130**
- Vinyl acetylene (buten-3-yne) **10 V130–V131**
mercury-bis-vinylethynyl **10 V130**
silver vinyl acetylene **10 V130–V131**
- Vinyl alcohol-acetate resin (VAAR)
10 V131–V132
- Vinylamine **10 V132**
- Vinyl aniline see Aminostyrenes **1 A257**
- Vinyl azide **10 V132**
- Vinyl benzene and derivs **10 V132–V133**
- Vinyl carbinol see Allyl alcohol **1 A135–A136**
- Vinyl chloride see Chloroethylene
3 C255–C256; Additional refs 10 V133–V135
analysis **10 V133**
explns **10 V133**
handling and storage **10 V133**
production **10 V133**
pyrolysis **10 V133–V134**
toxicity **10 V134**
uses **10 V134–V135**
- Vinyl compound toxicity **10 V142–V143**
- Vinyl cyanide **10 V135–V136**

- Vinylethylene see 1,3-Butadiene 2 B365–B366;
 Composite proplnts 3 C464–C474;
 Polybutadiene and its use as a binder with
 energetic materials 8 P327–P331,
 Polymerizations P344 (table; Proplnts, solid
 8 P412–P415 (table 17); Additional refs
 10 V136–V138
 analysis 10 V136
 energetic parameters 10 V136
 manufacture 10 V136
 safety 10 V137
 uses 10 V137–V138
- Vinylethyl ether 6 E339; see Visol 10 V145
- Vinyl ferrocene 10 V138
- Vinyl fluoride see Fluoroethylene 6 F140
- Vinyl-2,2,2-fluorodinitroethyl ether polymer
 10 V138
 , (monomer) 10 V138
- Vinylfluoride polymer 6 F150
- Vinylhaloacetylene polymers 10 V139
- Vinylidene chloride see Dichloroethylene
 5 D1210–D1211; Polymerization, violent
 8 P345 (table); Additional refs 10 V139
- Vinylidene chloride monoperoxide
 10 V139–V140
- Vinylidene fluoride see 1,1-Difluoroethylene
 6 F133; Additional refs 10 V140–V141
- Vinylidene resins 6 F150
- Vinyl Li 10 V141
- Vinyl nitrate polymer see Polyvinyl nitrate
 (PVN) 8 P356–P358; Additional refs
 10 V141–V142
- Vinyl polymers see Polyvinylacetate or
 Polyvinylalcohol or Polyvinyl chloride or
 Polyvinyl nitrate (PVN) 8 P353–P358
- Vinyl pyridines and derivs 10 V142
 α -vinylpyridine 10 V142
 2-vinylpyridinium perchlorate polymer
 10 V142
 γ -vinylpyridine 10 V142
- Violette (poudre) (Fr) 10 V144
- Viper light anti-tank weapon 10 V144
- Virgo 10 V144–V145
- Virial (detonation) equation of state 4 D293
- Virite see Italian expls 7 I181
- Visol 10 V145
- Vitesse de combustion (Fr) 10 V145–V146
- Vitesse de detonation (Fr) see Detonation rate
 determination 1 X
- Viton 10 V146
- Vivacite de combustion des poudres see
 Coefficient de vivacite des poudres
 3 C390–C391; Proplnts, solid 8 P404
- Vivacite, determination de la (Fr) see Quickness
 of burning of proplnts, determination 1 XXI;
 3 C390–C391
- Voigt expls 10 V146
- Volatiles, total 10 V146–V155
 , by method 101.5 (3 Aug 1962) 10 V155
 , by method 101.6 (3 Aug 1962) 10 V155
 , by method 103.1.3 (15 July 1969)
 10 V146–V148
 , by method 103.3.3 (1 Dec 1967)
 10 V148–V152
 , by method T103.5.1 (30 Dec 1975)
 10 B152–V155
- Volatility of expls and related substances
 1 XXVI
- Volkman, Friedrich 10 V156
- Volksgewehr (Ger) 10 V156–V157
- Volkspistole (Ger) 10 V157
- Volney, Carl Walter 10 V157
- Volpert 10 V157
- Volume of gases evolved on expln or detonation
 1 XXVI
- Volume, specific 10 V158–V162
 ; applications of v_1 10 V161–V162
 , introduction to 10 V158
 ; semi-empirical methods 10 V160–V161
 ; theoretical computations of v_1
 10 V158–V160
- Volume strength see Strength of expls 9 S219
- Volumex 10 V163
- Von Brank's powder see Brank's powders 2 B261

Von Dahmen expls see Dahmen, Johann, von
and Dahmenit A 3 D1

Von Geldern, Egmont 10 V163

Vonges, Dynamites de 10 V163

Von Stubenrauch's expls see Stubenrauch's
expls 9 S223

Vorlage (Ger) 10 V163

Vortices, expl powered 10 V163–V164

Voswinkel 10 V164

V (poudre) 10 V164

Vril expls 10 V164

VT fuzes see Proximity srtilery fuzes
4 D918–D921, Bomb proximity fuzes
D995–D998; Fuzes 6 F255–F257;
Additional refs 10 V164–V165

Vukolov, S.P. (1863–1940) 10 V165

Vulcain Dynamite 10 V165

Vulcaine 10 V165

Vulcan 10 V165–V166

Vulcania DB and DBS see Italian expls 7 I181

Vulcanienne (poudre) see Espir powder 5 E127

Vulcanite 10 V166

Vulcan Dynamite 10 V166

Vulnerability of a target 10 V166–V170

, major elements of analysis of
10 V168–V170

, role of analysis of 10 V168

, systems analysis 10 V167–V168

VX 10 V170

, chemistry of 10 V170

, decontaminants for 10 V170

, properties of 10 V170

, toxicity of 10 V170

W

- WAAM program 10 W1–W2
 ACM (anti-armor cluster munitions) 10 W1
 cyclops 10 W1
 ERAM (extended range anti-armor mine)
 10 W1
 WASP (mini-missile) 10 W1–W2
 Waffen 10 W2
 Wagner 10 W2
 Wahlenberg 10 W2
 Walleye 10 W2
 Wallonite 10 W2
 Walker, John (1780–1859) 10 W2–W3
 Walsrode powders 10 W3
 Walsrode sicherheits-sprengstoffe 10 W3
 Walter expls 10 W3
 Waltham Abbey silvered vessel test 1 XXIV
 Walther 10 W3–W5
 Wanklin 10 W5
 W.A. (powder) 10 W1
 Ward and Gregory powder 10 W5
 Warhead, continuous rod 6 F180
 Warhead, discrete rod 6 F180
 Warmlagermethode 75° (Ger) 10 W5
 Warren 10 W5–W6
 Warrite 10 W6
 Wasacord 10 W6
 Wasagel 1 & P1 10 W6
 Wasamon W&F 10 W6
 Washing-out of HE from shells see Reclamation
 of energetic material components from
 ordnance ammunition 9 R146
 Washout 10 W6–W7
 WASP see WAAM program 10 W1–W2
 Wass 10 W7
 Wasserfall, peenemunde (Ger) 10 W7
 Water content see Moisture, and Moisture,
 analytical procedures 8 M149–M154
 Water-driven-injector transport 10 W8
 Water, effect on energetic materials see
 Moisture 8 M149–M154
 Water gels see Slurry expl 9 S121
 Water, its hazardous reactions and use in
 energetic materials 10 W8–W14
 ; effect on detonation parameters
 10 W11–W13
 ; safety aspects 10 W13–W14
 ; sensitivity data 10 W14
 ; with water reactive materials 10 W8–W11
 Water emulsion fuels, proplnts and propulsion
 systems see Liquid proplnts 7 L34–L44;
 Proplnts, solid 8 P430–P439; Additional refs
 10 W15–W16
 ; combustion 10 W15
 ; ignition 10 W15
 ; uses 10 W15–W16
 Water expls 10 W16–W17
 Water-pyrotechnic reactions see Moisture
 8 M150–M152; Additional refs 10 W17
 ; ignition and combustion 10 W17
 ; uses of 10 W17
 Water pollution caused by munition manufacture
 see Pollution abatement in the US military
 expls and proplnts manufacturing industry
 8 P317–P324; Nitration 8 N85–N86;
 Disposal of waste TNT 9 T277–T280
 Waterproofness test 10 W17–W18
 Water resistance of commercial expls 10 W19
 Water stemming see Stemming 9 S214
 Watervliet Arsenal 10 W19–W20
 Wax gap test 1 VIII
 Waxes—use in energetic materials 10 W20–W57
 ; analytical aspects&specifications
 10 W52–W54
 ; animal waxes 10 W21–W22
 ; binding/lubricating 10 W43–W47
 ; cast compositions using wax as the vehicle
 10 W41

- Waxes—use in energetic materials (cont'd)**
 ; cast TNT expls **10 W36–W41**
 ; densensitizing/phlegmatizing **10 W24–W28**
 ; fuels **10 W48–W50**
 ; inert simulants **10 W50–W51**
 ; insect waxes **10 W22**
 ; mineral waxes **10 W22**
 ; modified Comp A **10 W36**
 ; petroleum waxes **10 W22**
 ; preparation of pressed and cast loaded expls
 10 W41–W43
 ; pressed expls **10 W28–W36**
 ; sealant **10 W47**
 ; vegetable waxes **10 W22–W24**
- Weapons 10 W57**
 conventional weapons **10 W57**
 defensive weapons **10 W57**
 offensive weapons **10 W57**
 strategic weapons **10 W57**
 tactical weapons **10 W57**
 weapons of mass destruction **10 W57**
- Weapons, acoustic 10 W57–W59**
- Weapons, electric 10 W58–W59**
- Weber powder 10 W60**
- Webley 10 W60–W61**
- Web thickness 10 W61**
- Wedge test (detonation failure thickness)**
 10 W61–W62
- Wedge test (shock initiation properties)**
 10 W62–W65
 , techniques of **10 W63–W65**
- Weight strength see Strength of expls**
 9 S219–S220; 10 W65–W66
- Weiss-salz (white salt) 10 W66**
- Welgun 10 W66**
- Welin screw 10 W66**
- Wellite see Hebler powder 7 H59**
- Welrod 10 W66–W67**
- Wendland's expl 10 W67**
- Wenghoffer 10 W67**
- Wenograd test see Kinetics in expln phenomena**
 7 K12
- Westfalit 10 W67**
- Wettersprengstoffe 10 W67–W72**
 ammonsalpeter- **10 W67–W71**
 gelatinose- **10 W72**
 NG- **10 W72**
- Wetzler powder 10 W72**
- Weyel expls 10 W73**
- Wheeler's expl 10 W73**
- Wheel-lock 10 W73**
- Whistles, pyrotechnic 10 W73–W77**
- White compound see 8 N84;**
 Preparation **9 T241**; Purification **9 T244**,
 and Chemical reactions **9 T248**
- White German powder see Augendre powder**
 1 A507; 10 W77
- Whitehead, R. (1823–1905) 10 W77**
- White phosphorus 8 P253–P255**
- White powder 10 W77**
- Whole cartridge sensitivity test 4 D399**
- Wiener powders 10 W77**
- Wigfall powder 10 W77**
- Wilhelm expls 10 W77–W78**
- Wilhelmit 10 W78**
- Wilkins (detonation) equation of state 4 D294**
- William powder 10 W78**
- Will's stability test 10 W78**
- Winchester 10 W78–W79**
- Wind gun 6 G190**
- Windshield 10 W79**
- Windsor powder 10 W79–W80**
- Winter expl 10 W80**
- Wire-wound gun 10 W80**
- Withnell powder 10 W80**
- Witness plates (plate denting test) 1 XIX & XX;**
 Brisance **2 B266–B295 (table 1)**; Additional
 refs **10 W80–W81**
- Wohanka 10 W81**

Wohl 10 W81

Wohl (detonation) equation of state 4 D295

Wolf 10 W81

Woodbury expls 10 W81–W82

Wood gum see Gum 6 G186–G187

Woodnite 10 W82

**Woolrich testing gallery see Coal mining expls,
testing for permissibility 3 C372**

Wound ballistics 10 W82–W86

definitions of projectile flight ballistic
terminology 10 W82–W83

the bullet in flight 10 W84–W85

; ammunition design and wound effectiveness
10 W85

Wound ballistics (cont'd)

; conclusion 10 W86

; flechette 10 W86

; Heckler and Koch spoon-point 10 W86

; high velocity, high sectional density bullets
10 W85–W86

; high velocity, small caliber bullets 10 W85

; impact with the human target 10 W83–W84

; the human target 10 W84–W85

WP (wurfelpulver) (Ger) 10 W86

W (poudres) 10 W86

W (pulver) 10 W86

WRX see 5 D1118; H-16 7 H1

W-salz (Ger) see Cyclonite or RDX 7 H93

X

- X-4, Ruhrstahl (Ger) 10 X1
 X-7, Ruhrstahl (Ger) 10 X1
 Xactex 10 X1–X2
 Xanthine 10 X2
 Xanthylum perchlorate 10 X2
 X-cord 10 X2
 Xenon and its compounds 10 X2–X5
 alkali fluoroxenates (VI) 10 X4
 Ce chloro-xenate 10 X4
 monalkali xenates 10 X4
 Xe dioxide difluoride 10 X5
 Xenon fluorides 10 X5–X7
 Xe difluoride 10 X5
 Xe (II) fluoride methane-sulphonate 10 X6
 Xe (II) fluoride trifluoromethane-sulfonate 10 X6
 Xe fluoro perchlorate 10 X6
 Xe hexafluoride 10 X5–X6
 Xe orthotellurate 10 X6
 Xe oxide difluoride 10 X6
 Xe oxide tetrafluoride 10 X6
 Xe (II) pentafluoroorthoselenate 10 X7
 Xe tetrafluoride 10 X5
 Xe perchlorate 10 X7
 Xe tetrahydroxide 10 X7
 Xenon tetroxide 8 O53; Additional ref 10 X7
 Xe trifluoroacetate 10 X7
 Xe trioxide 8 O53; Additional refs 10 X7
 X-expls from LASL 10 X7–X10
 Xilit (Rus) 10 X11
 Xpdite 10 X11
 X-rays, action on energetic materials see
 Radiation effects on expls, proplnts and
 pyrotechnics 9 R42–R43
 X-ray diffraction analysis of energetic materials
 10 X11–X21
 glossary of x-ray diffraction terms
 10 X18–X20
 X-staff (tetan or tetranitromethane) (Ger)
 8 M83–M85; 10 X21
 XTX-8003 10 X21–X23
 chemical propertiex of 10 X22
 detonation properties of 10 X22
 manufacture of 10 X21
 sensitivity of 10 X22
 tensile strength and modules of 10 X22
 XTX-8004 10 X23
 chemical properties of 10 X23
 detonation properties of 10 X23
 manufacture of 10 X23
 sensitivity of 10 X23
 thermal properties of 10 X23
 Xylan dinitrate 10 X23–X24
 Xylene and derivs 10 X24–X26 see
 Dimethylbenzene 5 D1321–D1325;
 Additional refs 10 X24–X26
 dinitroxylyene nitrate 10 X25
 dinitroxylyenes 10 X25
 ethylxylene and derivs 6 E340–E341
 mononitroxylyenes 10 X24–X25
 tetranitroxylyenes 10 X26
 trinitroxylyenes 10 X25–X26
 xylene derivs 10 X24
 xylene isomers 10 X24
 o-xylene ozonide 8 O72–O73
 Xylenol, 2,4,6-trinitro-meta-5- 10 X26
 Xylidines see Copper (II) xylidine azide
 5 D1316–D1318; Ethylxylidines and derivs
 6 E341; 10 X26
 xylidine perchlorate 10 X26
 Xylite (Fr) see Xilite 7 I182, and Ksilil K19;
 10 X27
 Xylite P (Fr) 10 X27
 Xylitol 9 S227; Additional ref 10 X27
 Xylobrome 10 X27
 Xyloglodines 10 X27
 Xyloidine 10 X27
 Xylose and its nitrated derivs see Sugars and
 their nitrated derivs 9 S232–S233
 Xylyl see Trinitroxylyene, commercial
 5 D1324–D1325; Ksilil (Rus) 7 K19
 2 (X,Y-Xylyl) ethanol 10 X27
 Xytolite 10 X27

Y1

Y

Yaw 10 Y1–Y2

Yield stress 10 Y2

Yonckites 10 Y2

Yttrium picrate 10 Y3

Yucca, nitrated 10 Y3

Yuenyaku or kokoshokuyaka 10 Y3

Yugoslav weapons in current service 10 Y3

- Zabel 10 Z1
- Zabudskii, G.A. (1854–1930) 10 Z1
- Zabudsky, N.A. (1853–1917) 10 Z1
- Zaliwsky 10 Z1
- Zapata chronograph see Chronographs 3 C317
(ref 2)
- Zapon 10 Z1
- Ze'ev see Wolf 10 W81
- Zel'dovich & Kompaneets (detonation)
equation of state 4 D295
- Zell-igelit (Ger) 10 Z1
- Zellpech see Raschig weisspulver and raschit
9 R117
- Zellstoffabrik 10 Z2
- Zeltit see Celtite 2 C125
- Zerite 10 Z2
- Zhelatin (or studenisty) Dinamit see Russian
nonpermissible expls 3 C441
- Zhirov's expls 10 Z2
- Zinc 10 Z2–Z6
- Zn as a solvent in pyrometallurgy 10 Z5
 - Zn as ingredient in pyrotechnic smoke
mixtures 10 Z4
 - Zn dust, US military specification for 10 Z6
 - Zn in advanced electrochemical power sources
10 Z4–Z5
 - Zn, miscellaneous military uses of 10 Z5–Z6
 - Zn, occurrence and preparation 10 Z4
 - Zn oxide, thermodynamic properties of 10 Z3
 - Zn, physical properties of 10 Z2
 - Zn powder, combustion of 10 Z4
 - Zn, thermodynamic properties of 10 Z3
- Zinc abietate 10 Z6–Z7
- Zinc acetylde 1 A83
- Zinc amalgam 10 Z7
- Zinc ammonium nitrite 10 Z7
- Zinc azidodithiocarbonate 1 A637
- Zinc benzenediazonium chloride 10 Z7
- Zinc bromate 10 Z7
- Zinc bromide 10 Z7
- Zinc carbonate 2 C59
- Zinc chlorate 2 C201–C202
- Zinc chloride 10 Z7
- Zinc chlorite 3 C246
- Zinc chromate 3 C283
- Zinc dialkyls 10 Z8
- Zn diethyl 10 Z8
 - Zn dimethyl 10 Z8
 - Zn dipropyl 10 Z8
 - Zn divinyl 10 Z8
- Zinc diamminoazide 10 Z8
- Zinc diazide 1 A624–A625
- Zinc dihydrazide 10 Z8
- Zinc dipicrate see Zinc picrate 8 P283
- Zinc ethylsulphinat 10 Z8
- Zinc fluoride 6 F150
- Zinc fluorsilicate 6 F150
- Zinc formate 6 F171–F172
- Zinc hydrazide 10 Z8–Z9
- Zinc hydride 10 Z9
- Zinc hydroxide 10 Z9
- Zinc iodide test 10 Z9
- Zinc nitrate 8 N40; Additional refs 10 Z9
- Zinc nitrodiglycolamidic acid salt 5 D1262
- Zinc nitrohydrazinate 7 H200
- Zinc oxide 8 O53–O54; Additional refs
10 Z9–Z10
- Zn oxide containing expls 10 Z9–Z10
 - Zn oxide containing proplnts 10 Z10
 - Zn oxide containing pyrotechnics 10 Z10
- Zinc perchlorate 8 P169; Additional refs 10 Z10
- Zinc permanganate 10 Z10
- Zinc perchlorate tetraammoniate 8 P170
- Zinc peroxide 10 Z10–Z11

Zinc picrate 8 P283

Zinc stearate 9 S212

Zirconium and hafnium 10 Z11-Z23

 military specifications for Zr and Zr
 compounds 10 Z12

 oxidation characteristics of Zr 10 Z15-Z16

 safe handling of Zr 10 Z13-Z14

 , introduction to 10 Z11

 , neutron absorption characteristics of
 10 Z11-Z12

 , occurrence and economic factors affecting
 price structure 10 Z12-Z13

 , sources of technical data on 10 Z11

 , sources, supply and economics 10 Z12

Zr as an incendiary metal 10 Z16-Z17

Zr as a propellant fuel 10 Z21

Zr in pyrotechnic mixtures 10 Z17-Z21

Zr, miscellaneous pyrotechnic applications for
 10 Z21-Z22

Zirconium borohydride 10 Z23

Zirconium carbide 1 A83; Additional ref 10 Z23

Zirconium dibromide 10 Z23-Z24

Zirconium fluoride 6 F150

Zirconium hydride 10 Z24

Zirconium-lead alloys 10 Z25

Zirconium-nickel alloys 10 Z25

Zirconium nitrate 8 N40

Zirconium oxide hydroxide-perchlorate 10 Z26

Zirconium picrate 8 P283

Zirconium potassium fluoride 6 F150-F151

Zirconium sulfate 10 Z26

Z-salz, Z-stoff C and Z-stoff N 10 Z26

Zylonite 2 C95



DEPARTMENT OF THE ARMY
UNITED STATES ARMY
ARMAMENT RESEARCH, DEVELOPMENT AND ENGINEERING CENTER
PICATINNY ARSENAL, NEW JERSEY 07806-5000

AMSRD-AAR-MEE

28 JAN 2009

MEMORANDUM FOR Defense Technical Information Center, ATTN: DTIC-OQ
(Mr. Larry Downing), Ft. Belvoir, VA 22060

SUBJECT: Distribution Limitation Change

1. Request the distribution limitation statement be upgraded from Statement A (Approved for Public Release) to Statement C (U.S. Government Agencies and Their Contractors). Reason: Administrative/Operational Use, effective 23 January 2009 for the following documents:

AD422747 . ADA011845
AD257189 ADA019502
AD274026 ADA057762
AD653029 ADA097595
AD745472 ADA134347
AD768069 3

2. Organization requesting this change is:

Commander
U.S. Army RDECOM-ARDEC
ATTN: AMSRD-AAR-MEE
Bldg. 321
Picatinny Arsenal, NJ 07806-5000

3. Any questions please contact the undersigned at (973) 724-4287 or
ross.benjamin@us.army.mil.

ROSS C. BENJAMIN
Director, Energetics, Warheads
& Manufacturing Technology
Directorate, METC



DEPARTMENT OF THE ARMY
UNITED STATES ARMY
ARMAMENT RESEARCH, DEVELOPMENT AND ENGINEERING CENTER
PICATINNY ARSENAL, NEW JERSEY 07806-5000

AMSRD-AAR-MEE

16 April 2009

MEMORANDUM FOR Defense Technical Information Center, ATTN: DTIC-OQ
(Mr. Larry Downing), Ft. Belvoir, VA 22060

SUBJECT: Recinding Distribution Limitation Change Request dated 23 Jan 09

1. After further review, I am recinding my request dated, 23 Jan 09, SUBJECT: Distribution Limitation Change Request. The below documents should remain with distribution Statement A (Approved for Public Release):

AD422747	ADA011845
AD257189	ADA019502
AD274026	ADA057762
AD653029	ADA097595
AD745472	ADA134347
AD768062	

2. Rationale: The change was not advisable since the documents have already been in the public domain (distribution statement A) for many years and the information is widely available.

3. Any questions please contact the undersigned at (973) 724-4287 or ross.benjamin@us.army.mil.

A handwritten signature in cursive script that reads "Ross C. Benjamin".

ROSS C. BENJAMIN
Director, Energetics, Warheads
& Manufacturing Technology
Directorate, METC